

K'nex

BUILDER'S CHOICE

Building Set

CHOIX DU CONSTRUCTEUR

Jeu de construction

35 BUILDS
MODÈLES*

Ages

7-12

17520

⚠ WARNING:

CHOKING HAZARD – Small parts.
Not for children under 3 years.

⚠ ATTENTION :

RISQUE D'ÉTOUFFEMENT – Pièces de petite taille.
Ne convient pas aux enfants de moins de 3 ans.

IMAGINE™



*Modelos
Modelli
Modelo
Modellen

Building Basics

Bases de Construction

Start Building

Each K'NEX piece has its own shape and color. Try to position your model in the same direction as the instructions. Faded colors show you this section is already built.

Démarre ta Construction

Chaque K'NEX pièce a sa propre forme et sa propre couleur. Pour te faciliter la tâche, oriente le modèle dans le même sens que les instructions. Les pièces ayant une couleur estompée sont celles déjà assemblées.

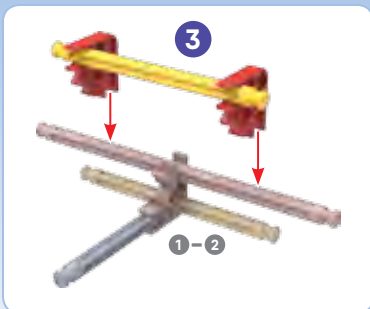
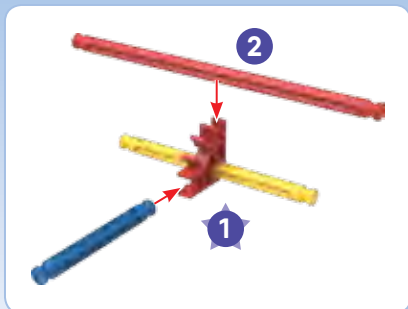

Connectors

Push these special connectors together tightly until you hear a "click".

Connecteurs

Pousse connecteurs spéciaux fort jusqu'à entendre un « clic ».

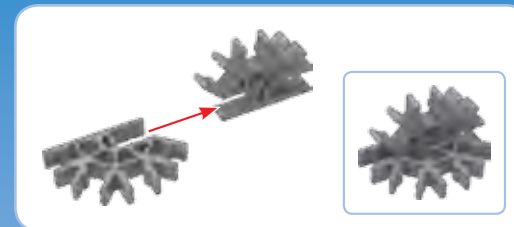
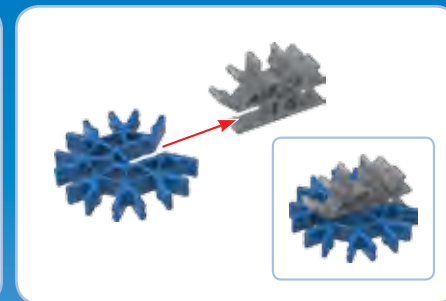
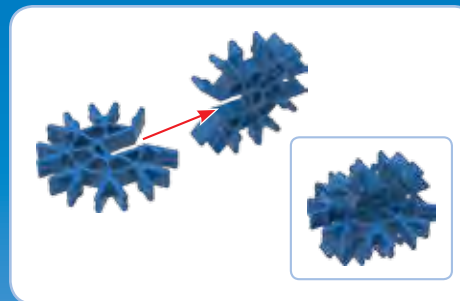

Spacers

Be sure to use the correct color and number of spacers shown.

Séparateurs

Assure toi d'utiliser la bonne nombre de séparateurs.



Flexible Rods

You can bend a flexible rod to make curved shapes. It will be easier to attach to your model if you bend it back and forth a few times first.

Tiges flexibles

Un Flexi-rod est une tige que tu peux courber pour faire des courbes. Elle pourra être attachée plus aisément à ton modèle si tu la plies en avant et en arrière plusieurs fois.

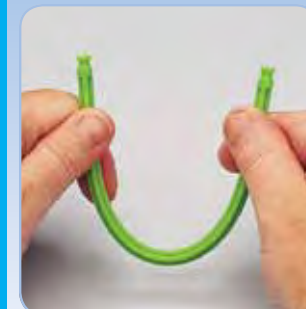

CONTENTS

PARROT	4
BATTLESHIP	4
ELEPHANT	5
PICK-UP TRUCK	6
HELICOPTER	7
DINOSAUR	10
MOTORCYCLE	12
3 WHEELED CYCLE	14
HOT ROD	17
FERRIS WHEEL	22
BUILDING IDEAS	26

CONTENU

PERROQUET	4
NAVIRE CUIRASSÉ	4
ÉLÉPHANT	5
CAMION DE COLLECTE	6
HÉLICOPTÈRE	7
DINOSAUR	10
MOTO	12
CICLETA DE 3 RUEDAS	14
HOT-ROD	17
GRANDE ROUE	22
IDÉES DE CONSTRUCTION	26



(EN) **WARNING:** CHOKING HAZARD

– Small parts. Not for children under 3 years.

CAUTION: Keep hands, face, hair and clothing away from all moving parts.

(FR) **ATTENTION :** RISQUE D'ÉTOUFFEMENT

– Pièces de petite taille. Ne convient pas aux enfants de moins de 3 ans.

ATTENTION : Garde les cheveux, les doigts, la figure et les vêtements à l'écart de toutes les pièces mobiles.

(ES) **ADVERTENCIA:** PELIGRO DE ASFIXIA – Piezas pequeñas. No para niños menores de 3 años.

PRECAUCIÓN: Mantén el cabello, los dedos, la cara y la ropa alejada de las piezas móviles.

(DE) **ACHTUNG:** ERSTICKUNGSGEFAHR – Kleinteile. Nicht geeignet für Kinder unter 3 Jahren.

VORSICHT: Haare, Finger, Gesicht und Kleidungsstücke nicht mit beweglichen Teilen in Berührung kommen lassen.

(IT) **AVVISO:** PERICOLO DI SOFFOCARE – Pezzi piccoli. Non adatto per bambini sotto 3 anni.

ATTENZIONE: Tenere i capelli, le dita, il viso e i vestiti lontano da tutte le parti in movimento.

(PT) **AVISO:** PERIGO DE SUFOCAÇÃO – Peças pequenas. Não se destina a crianças com menos de 3 anos de idade.

CUIDADO: Mantém o cabelo, os dedos, a cara e a roupa afastados de todas as peças móveis.

(NL) **WAARSCHUWING:** INSLIKKINGSGEVAAR – Kleine onderdelen. Niet geschikt voor kinderen jonger dan 3 jaar.

LET OP: Hou het haar, de vingers, het gezicht en kledij verwijderd van alle bewegende onderdelen.

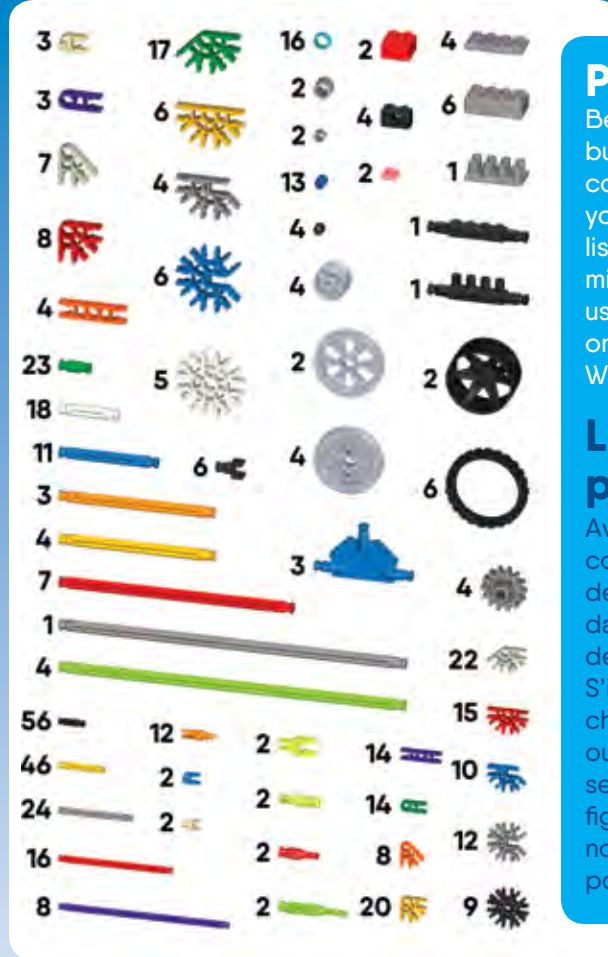

Parts List

Before you start building, be sure to compare the parts in your set with the parts list here. If anything is missing call or write to us using the information on the back cover. We're here to help you!

Liste des pièces

Avant de commencer à construire, assure-toi de comparer les pièces dans ta boîte à la liste de pièces fournie ici. S'il manque quelque chose, téléphone-nous ou écris-nous en te servant des informations figurant au verso de la notice. Nous sommes là pour t'aider.

Parrot
Perroquet
Loro

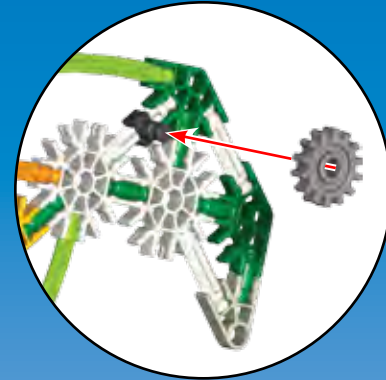
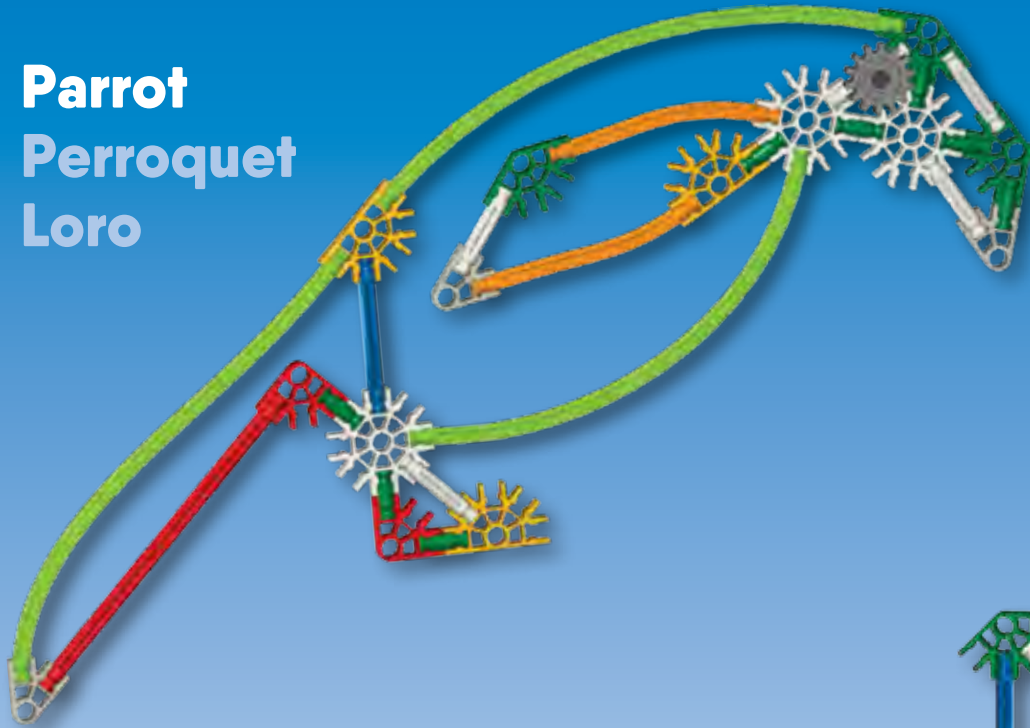

Battleship
Navire cuirassé
Nave de Batalla

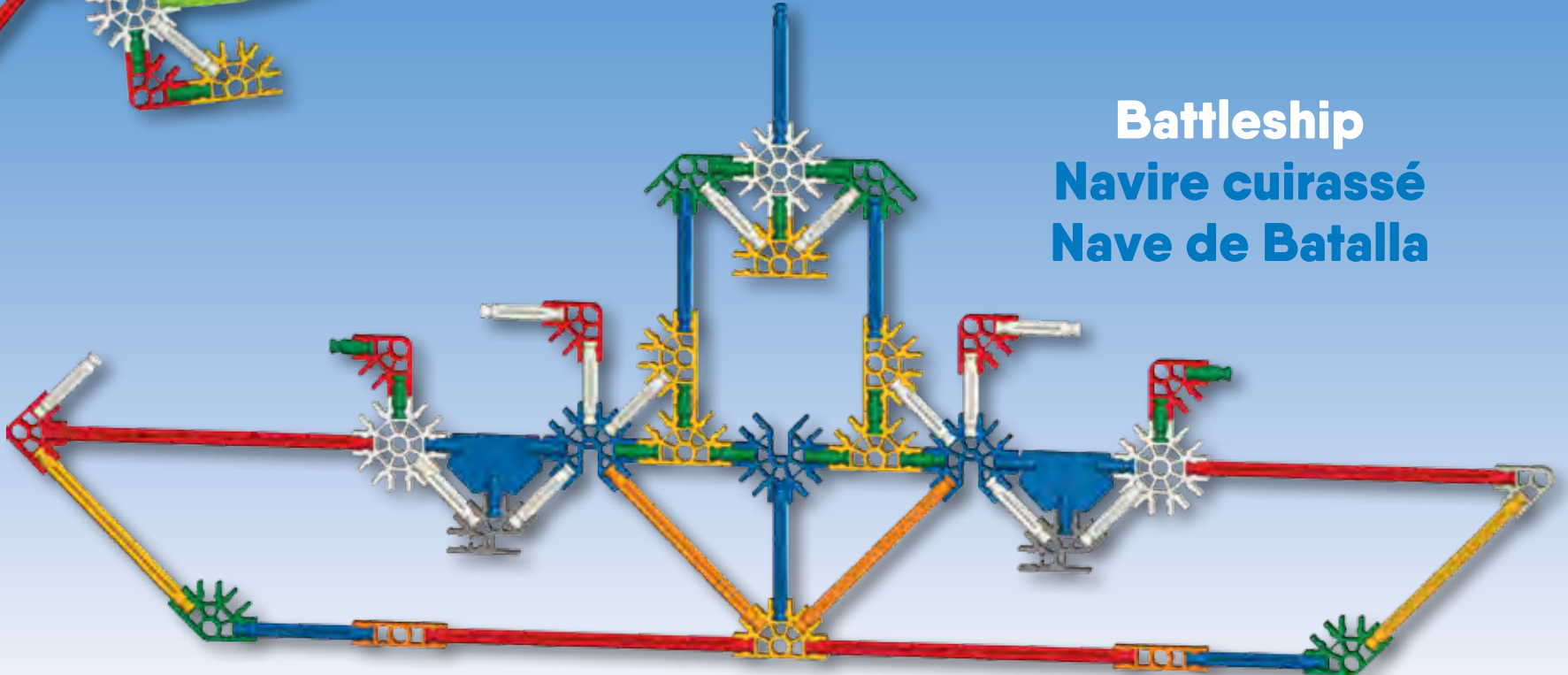

Elephant
Éléphant
Elefante

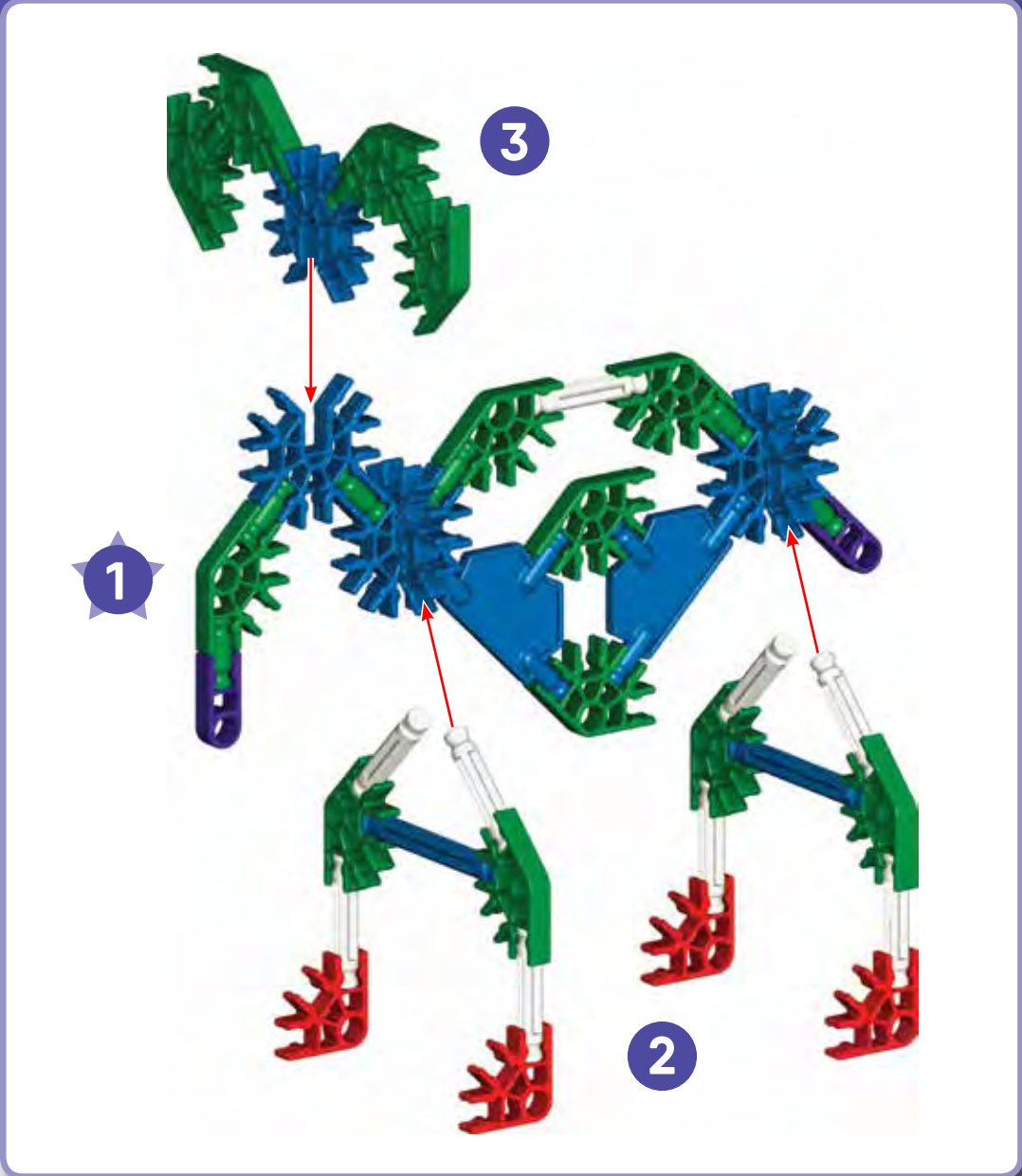
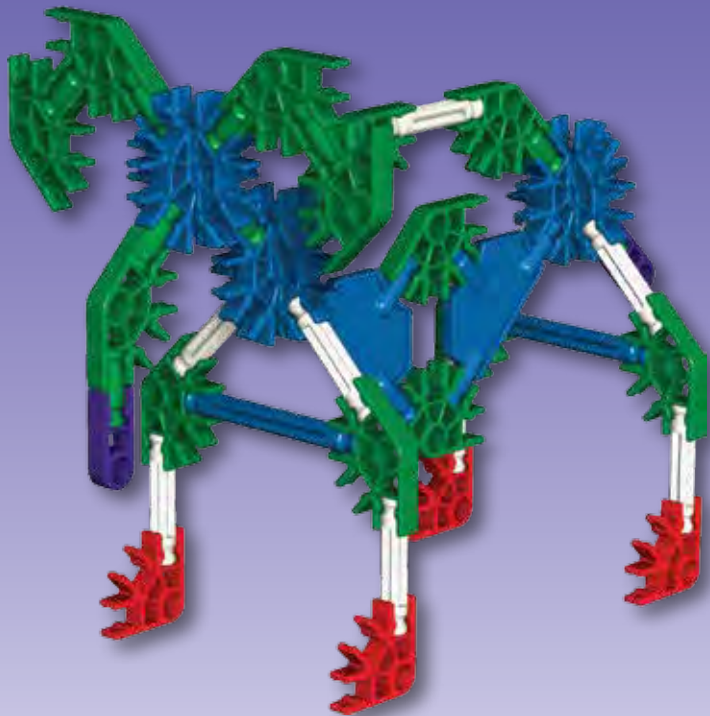

Pick-Up Truck

Camion de Colecte

Carro de Recolección

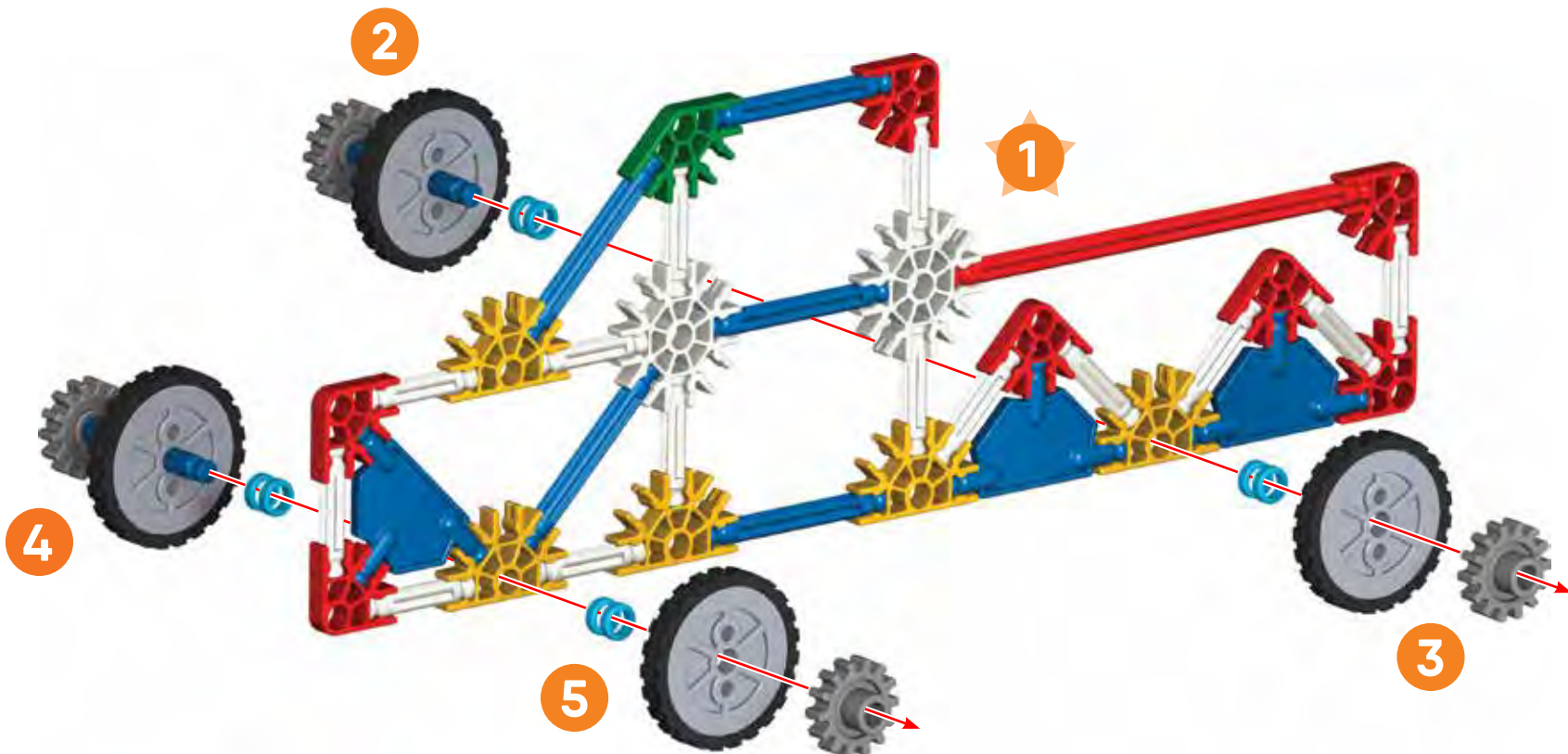



Helicopter
Hélicoptère
Helicóptero

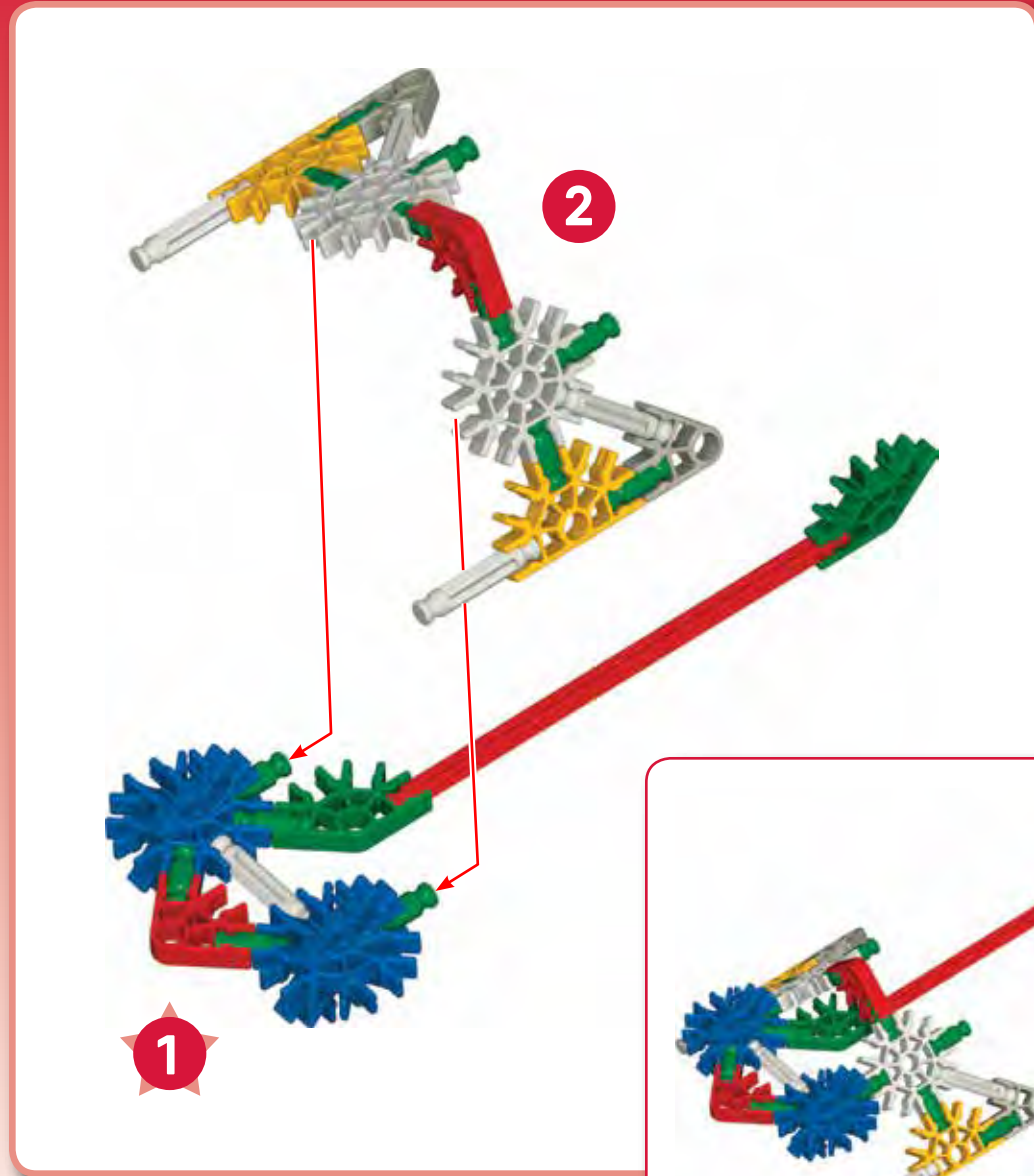

1-2

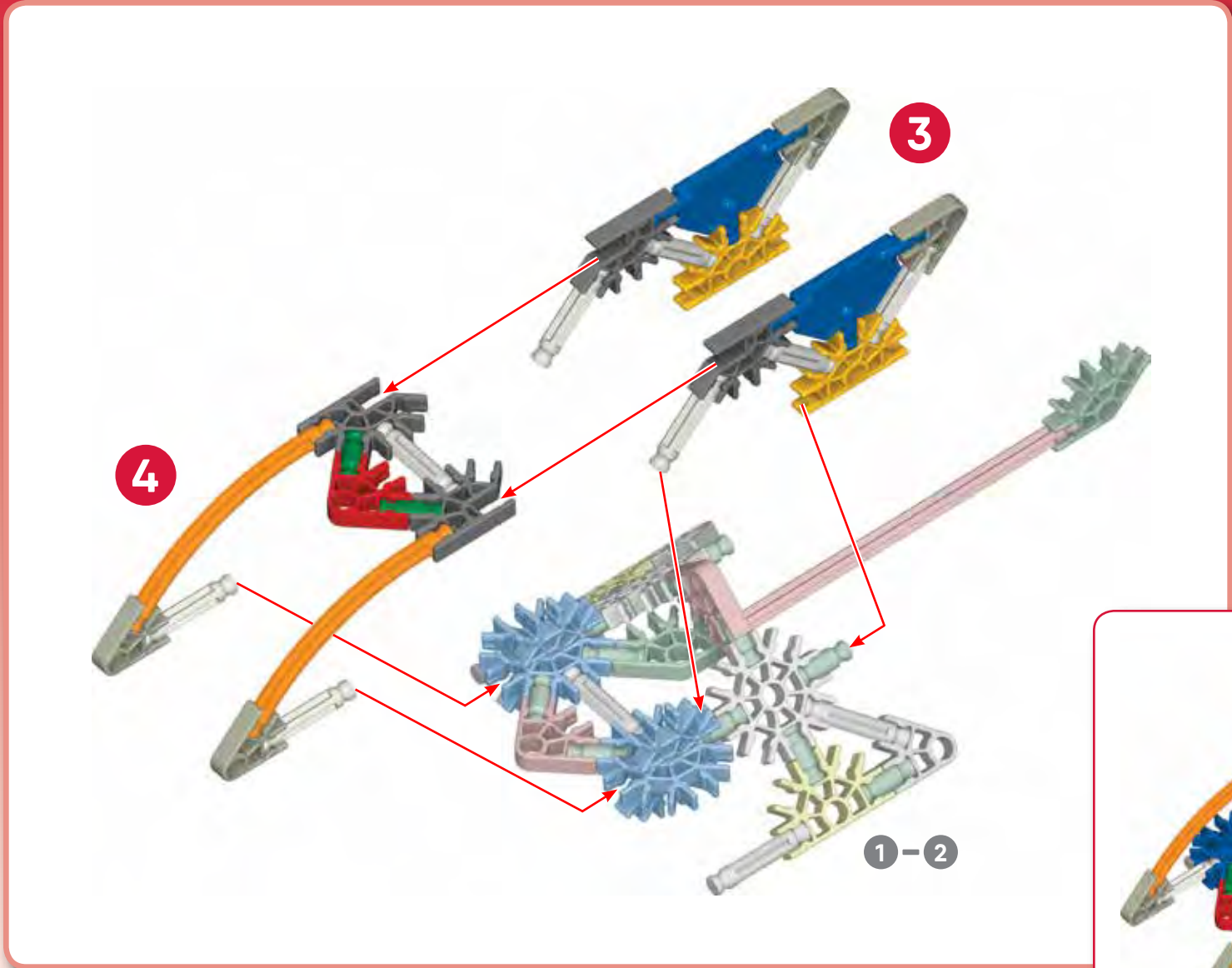

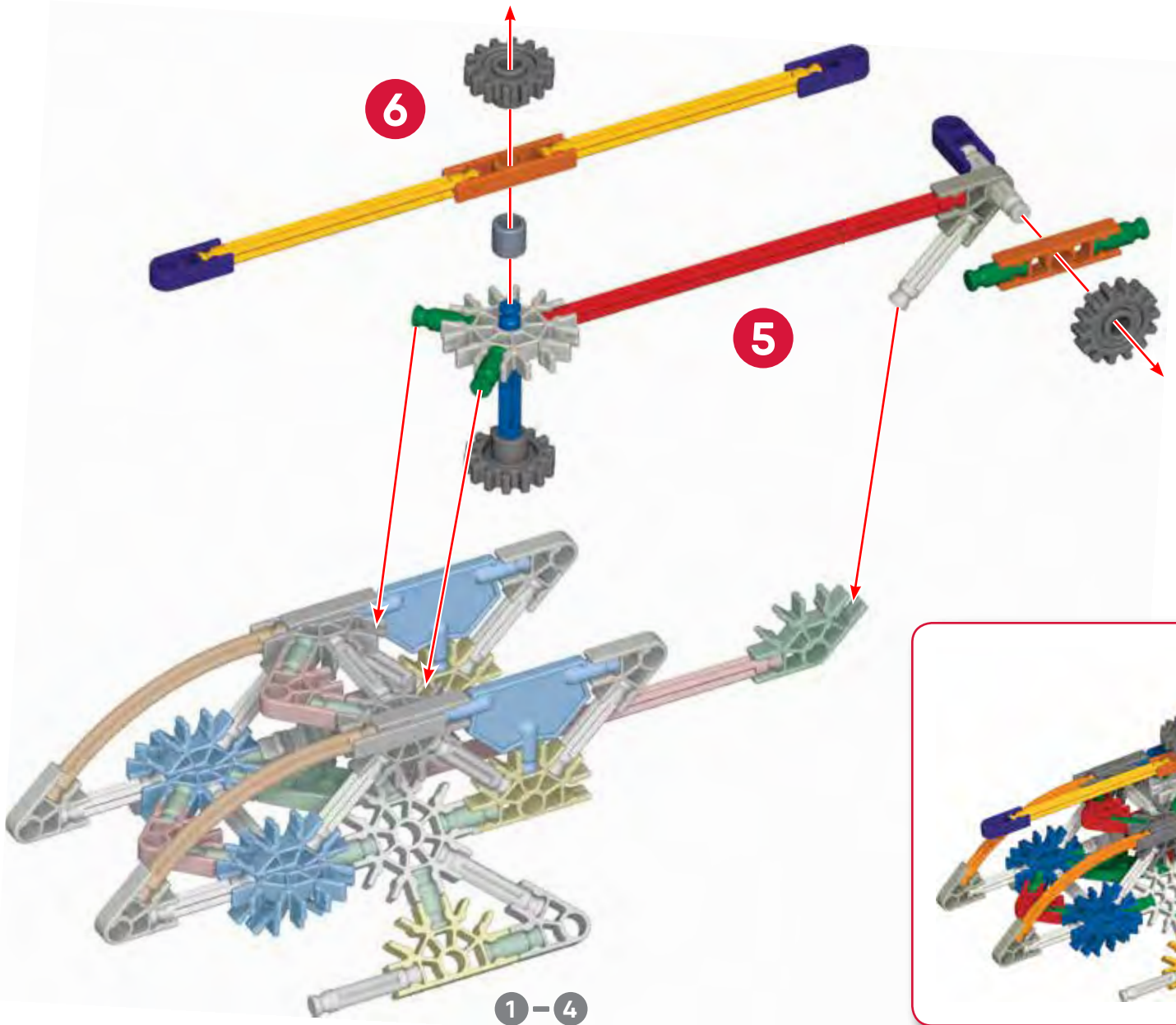

Dinosaur
Dinosaur
Dinosaurio

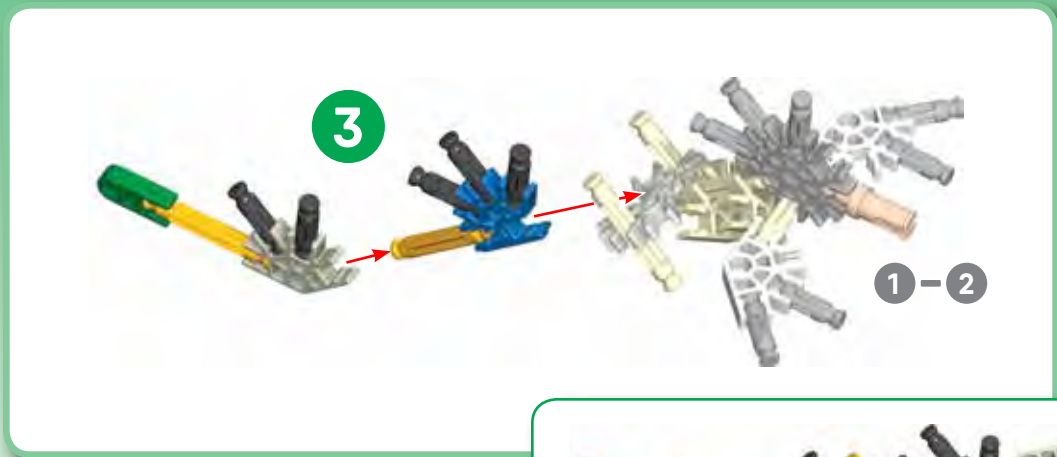
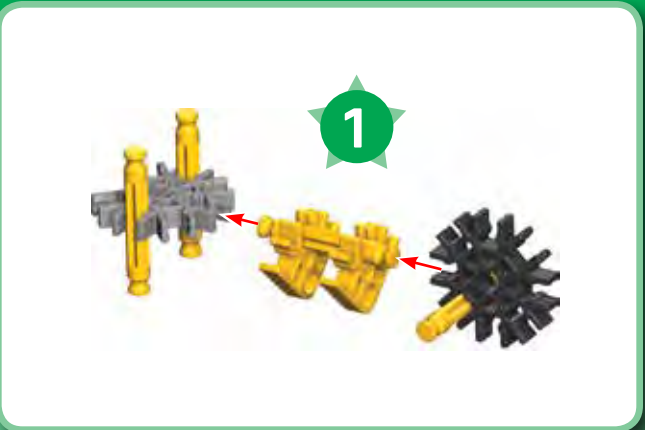

1-4



1-3

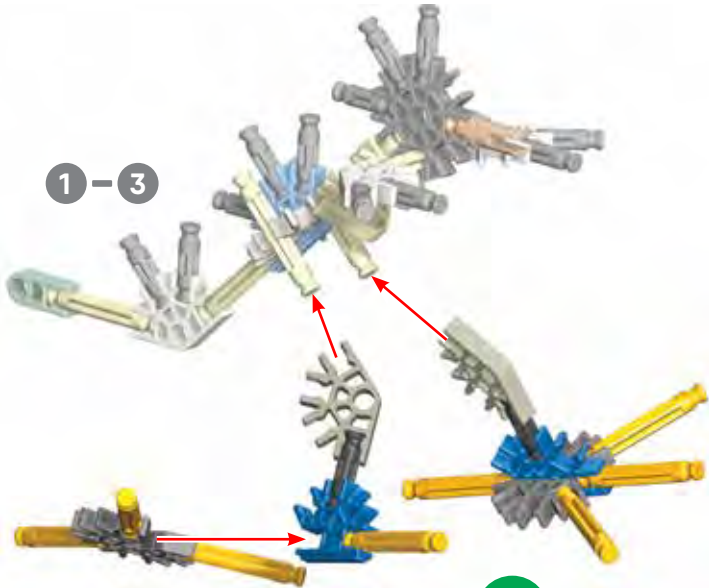

4

1-4

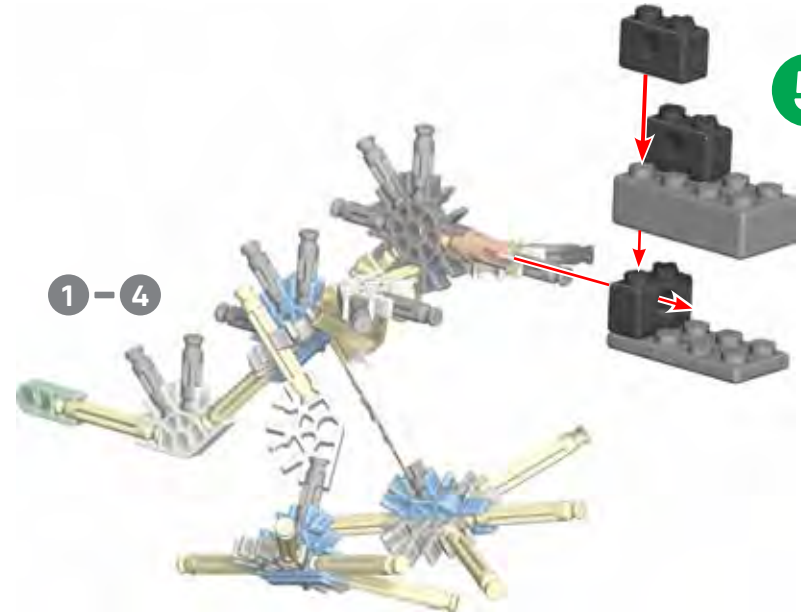

5



1-5

Motorcycle

Moto

Motocicleta

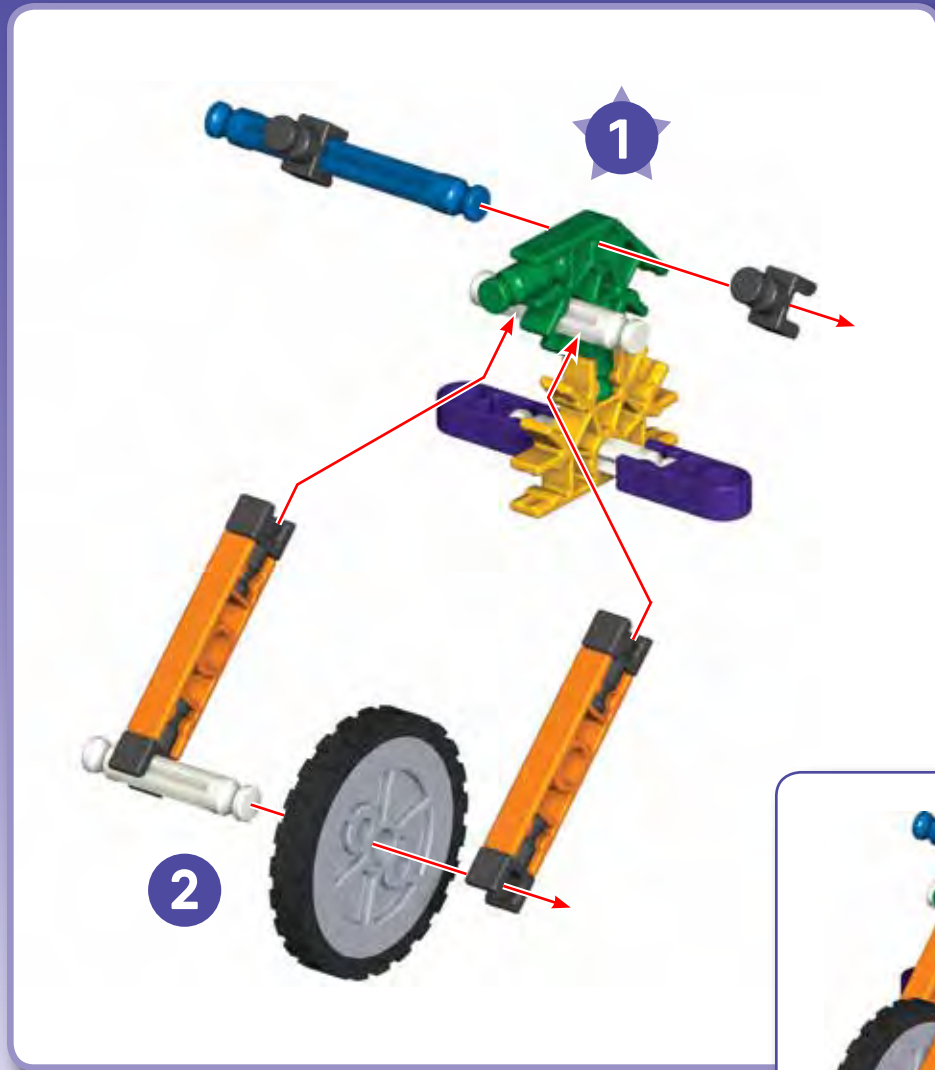

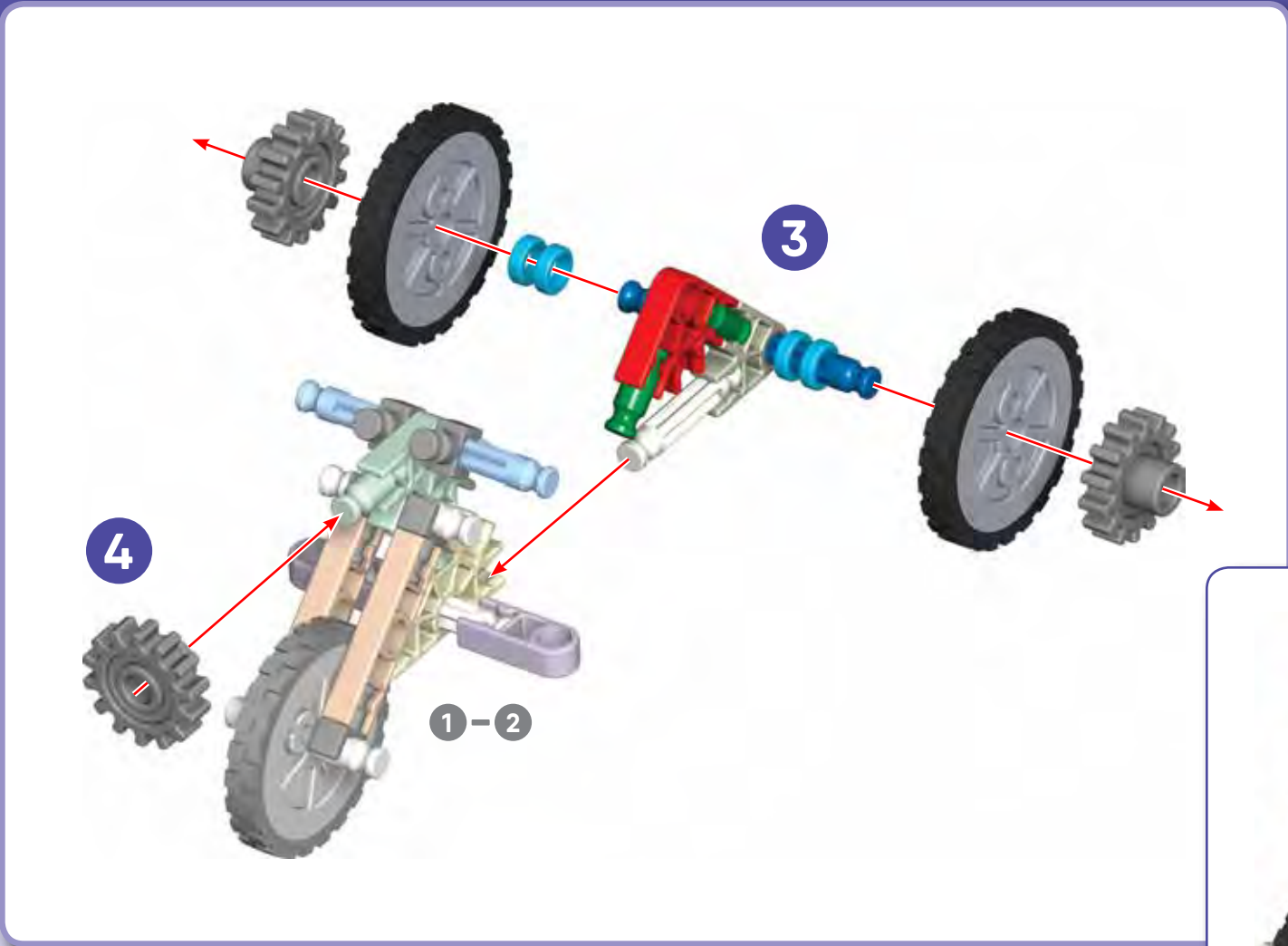

3 Wheeled Cycle Cicleta de 3 Ruedas Moto de 3 Roues

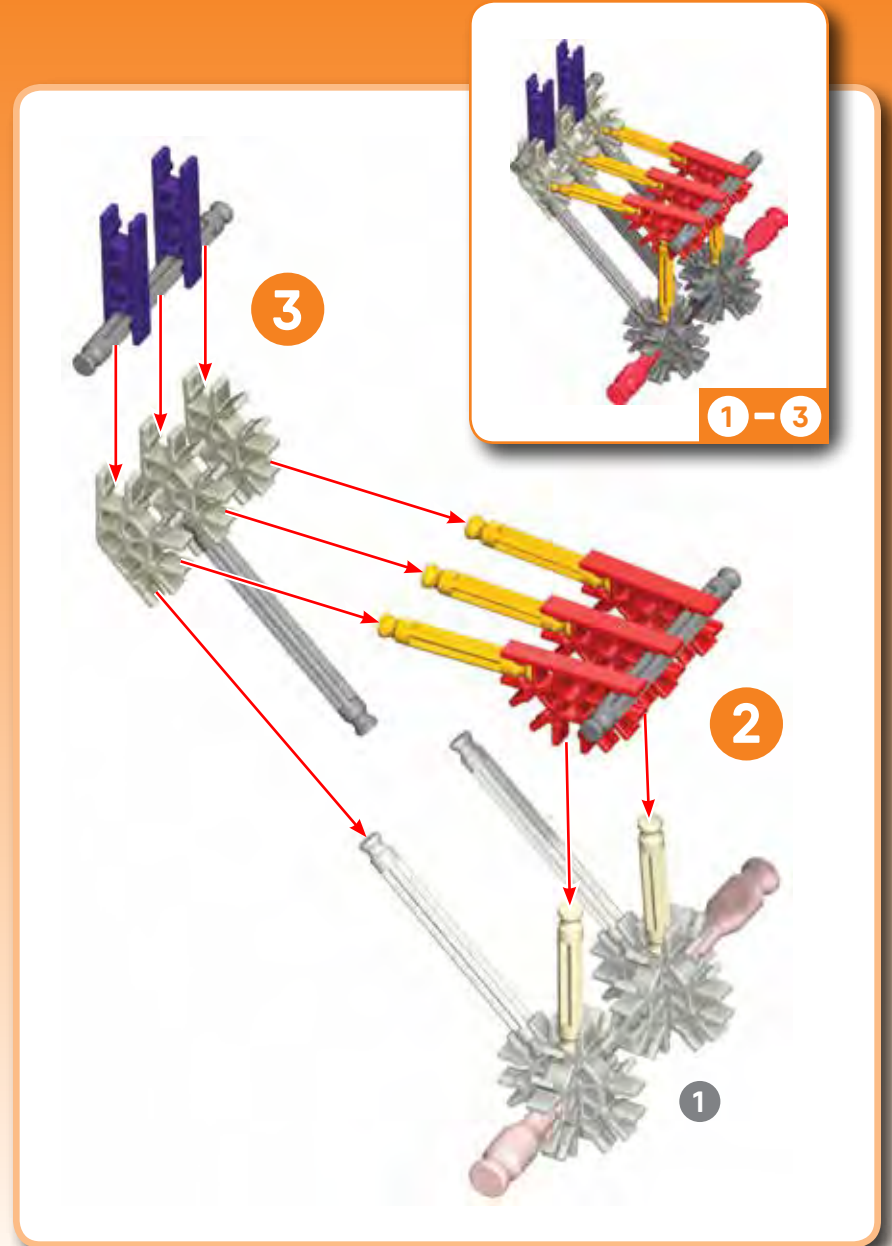

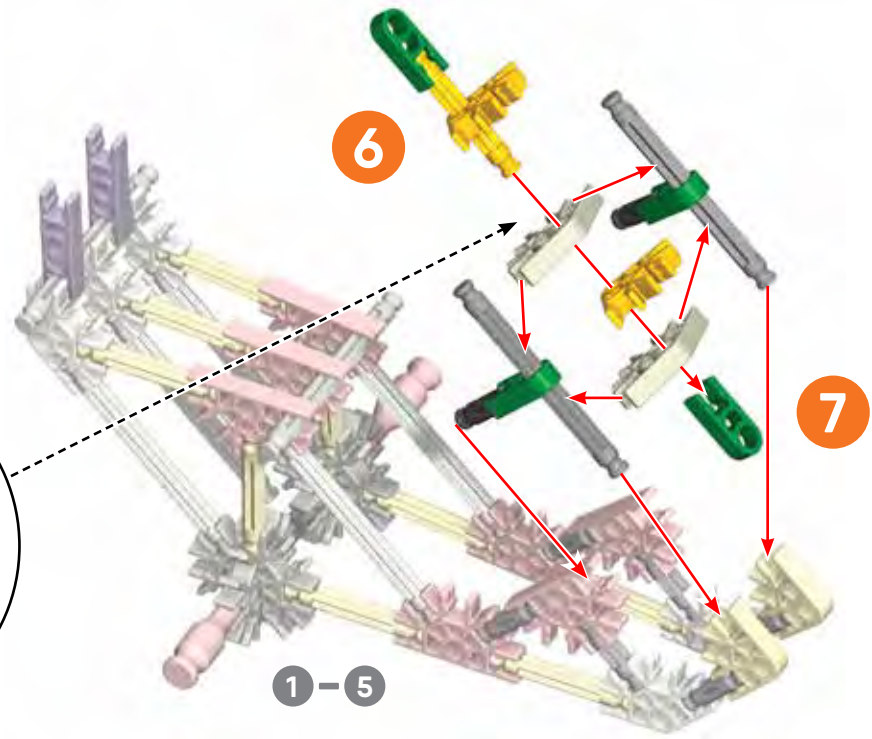
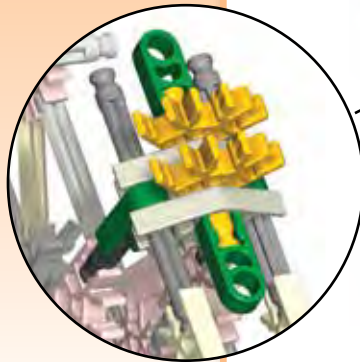
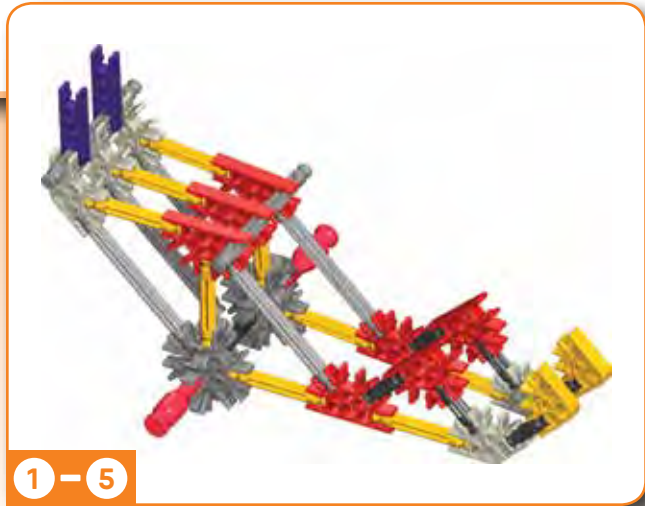
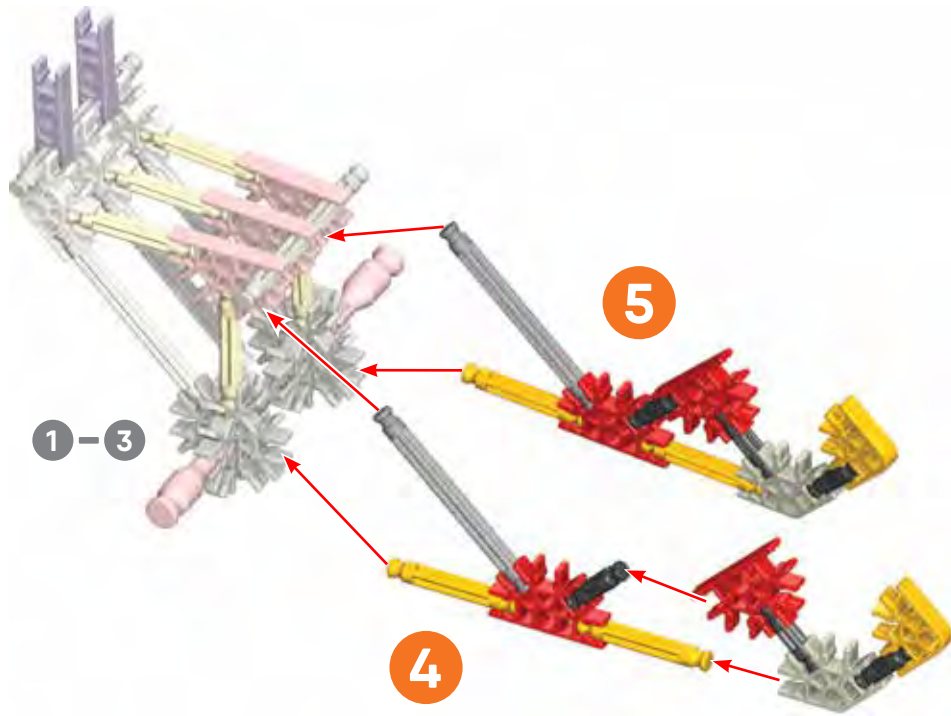

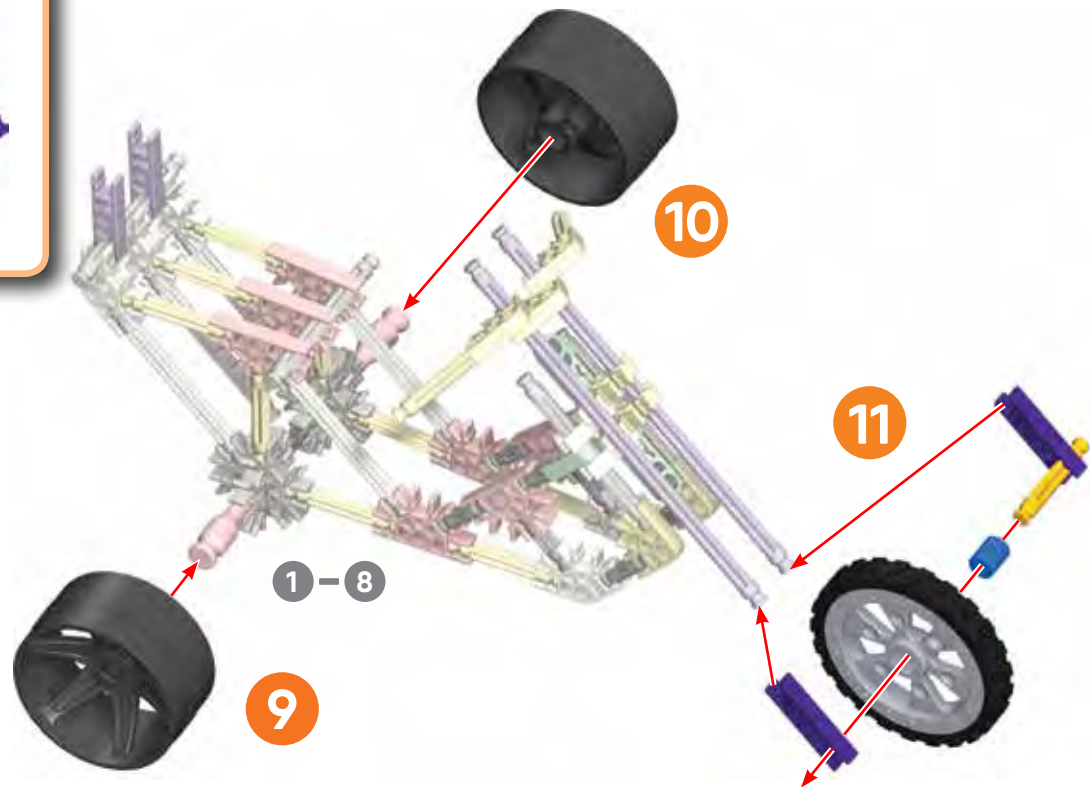
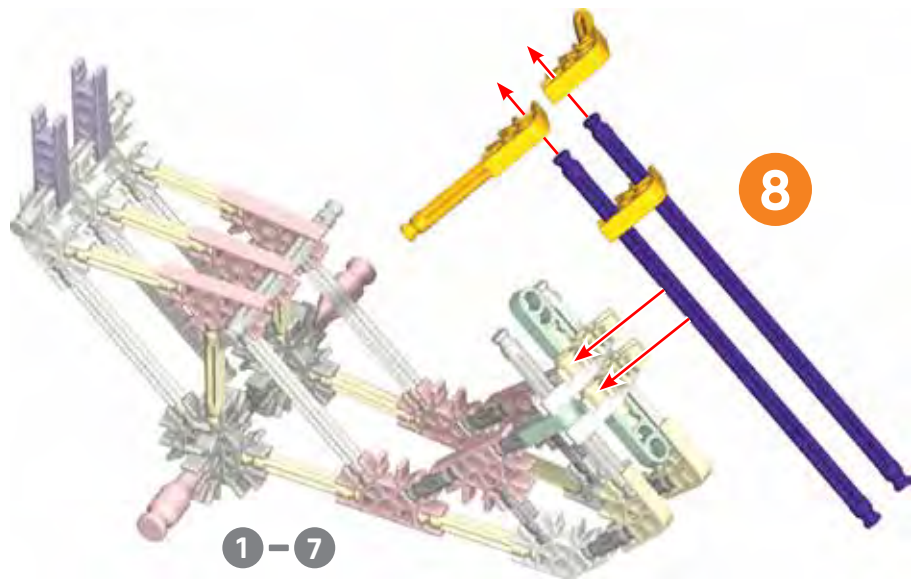

Hot Rod Hot-Rod Bólide

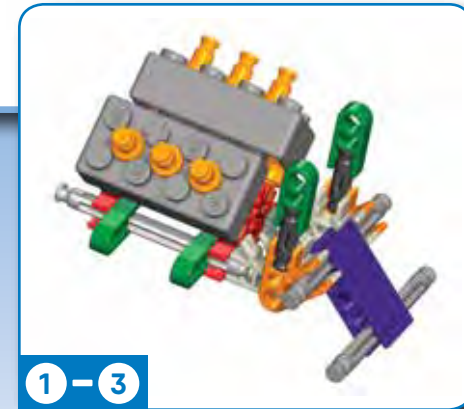
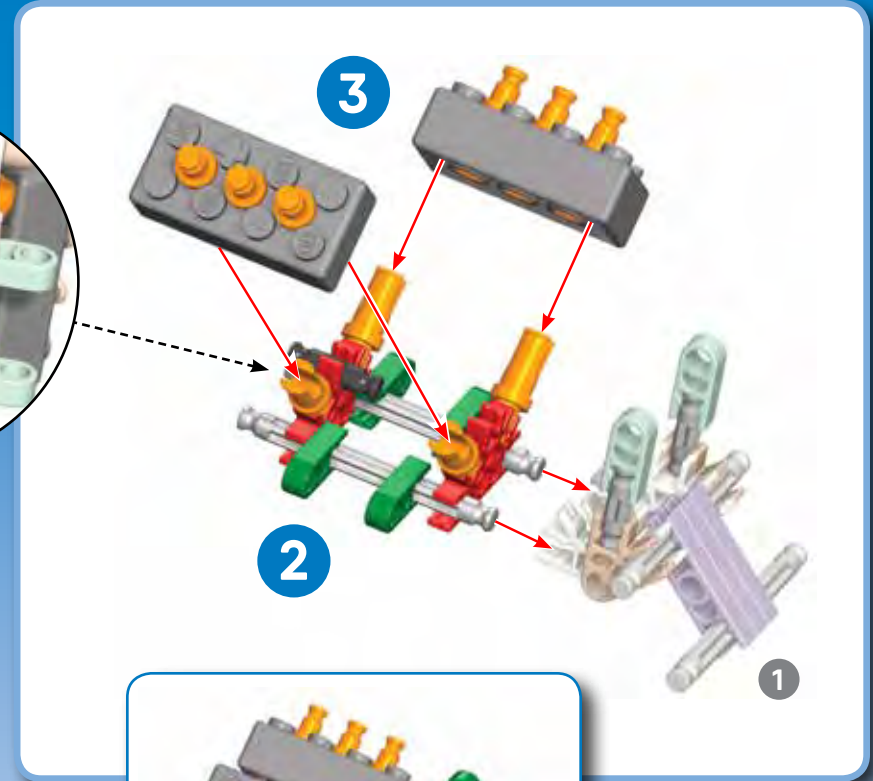
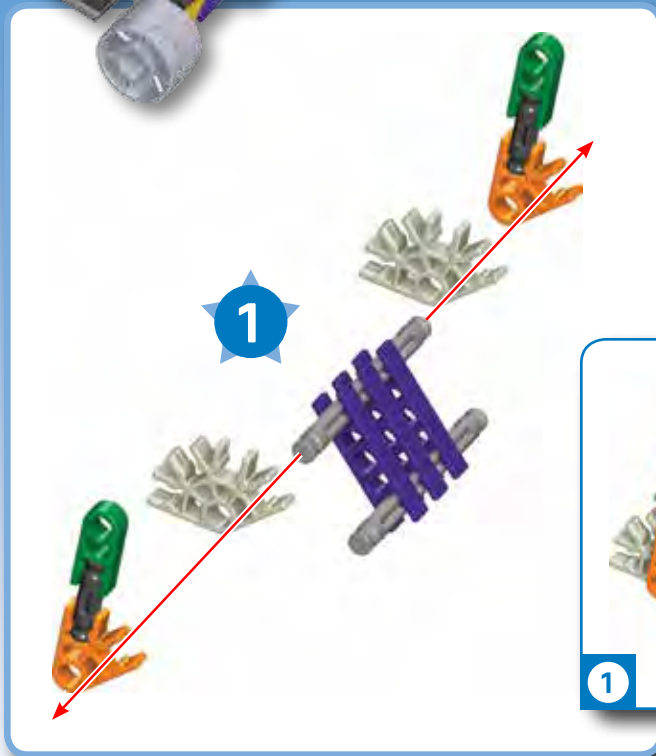
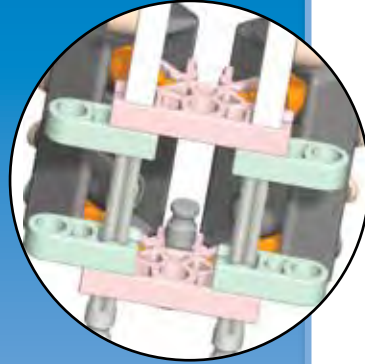
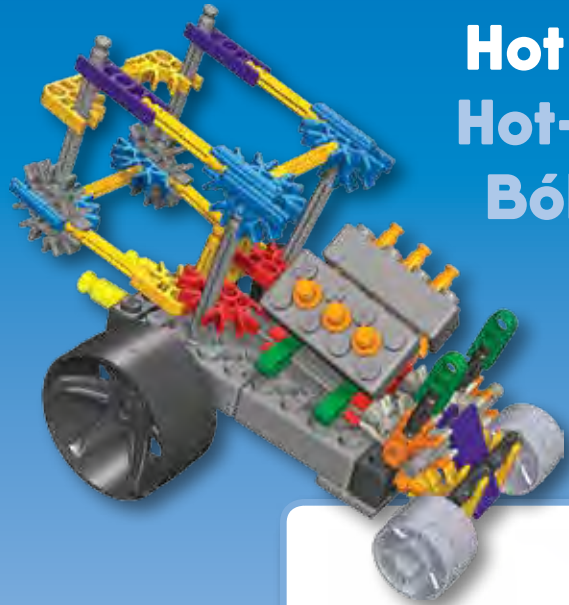

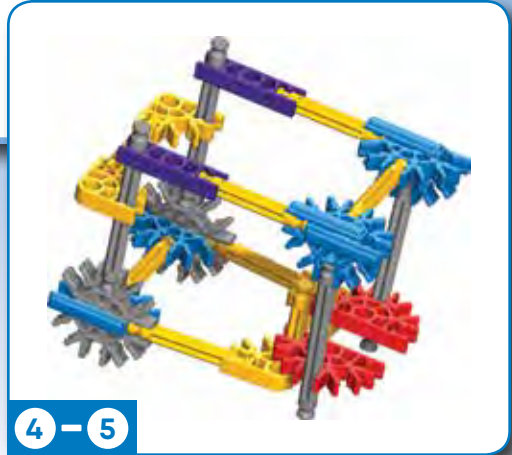
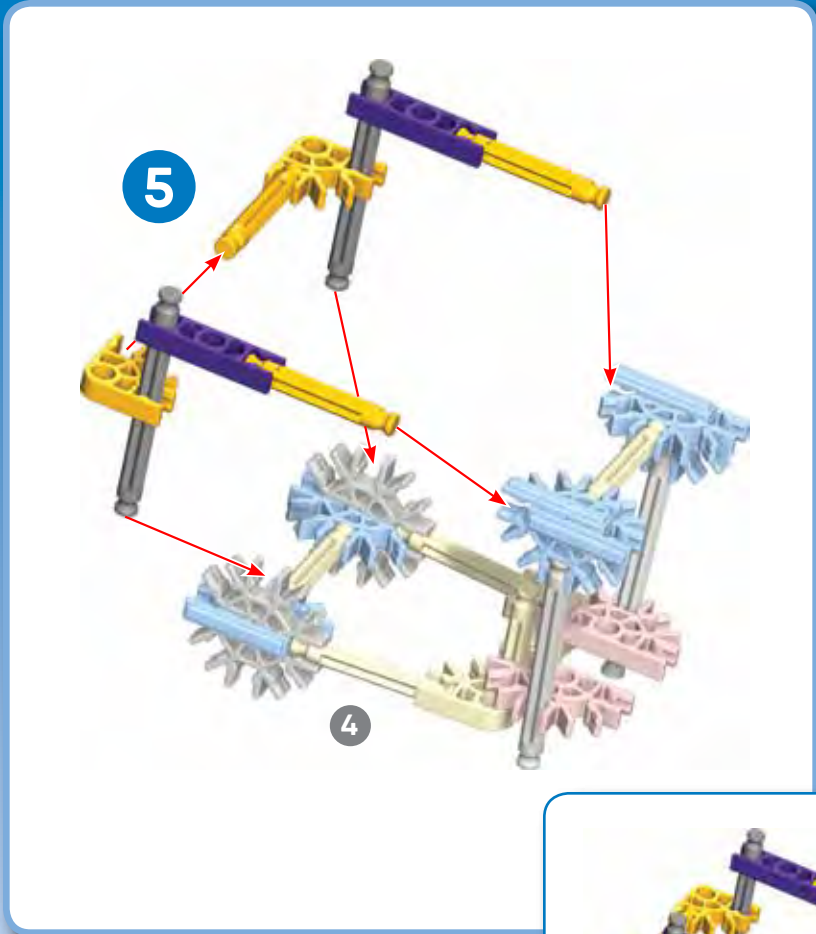
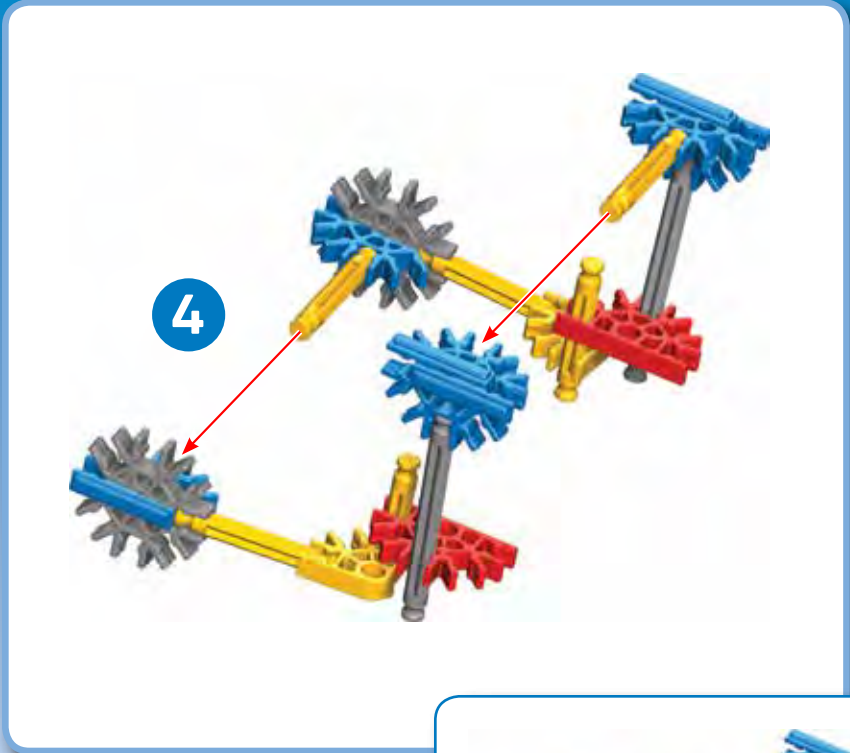

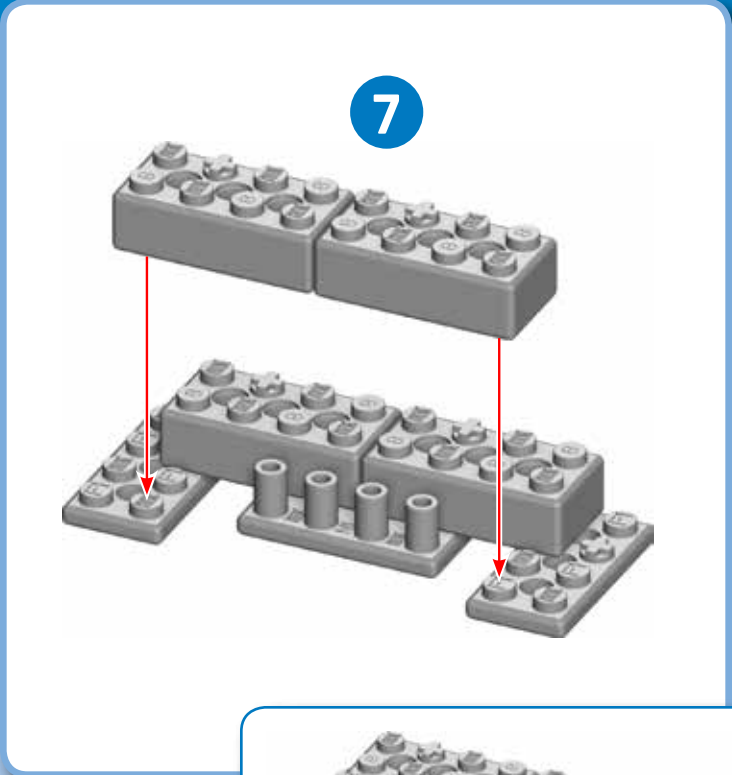
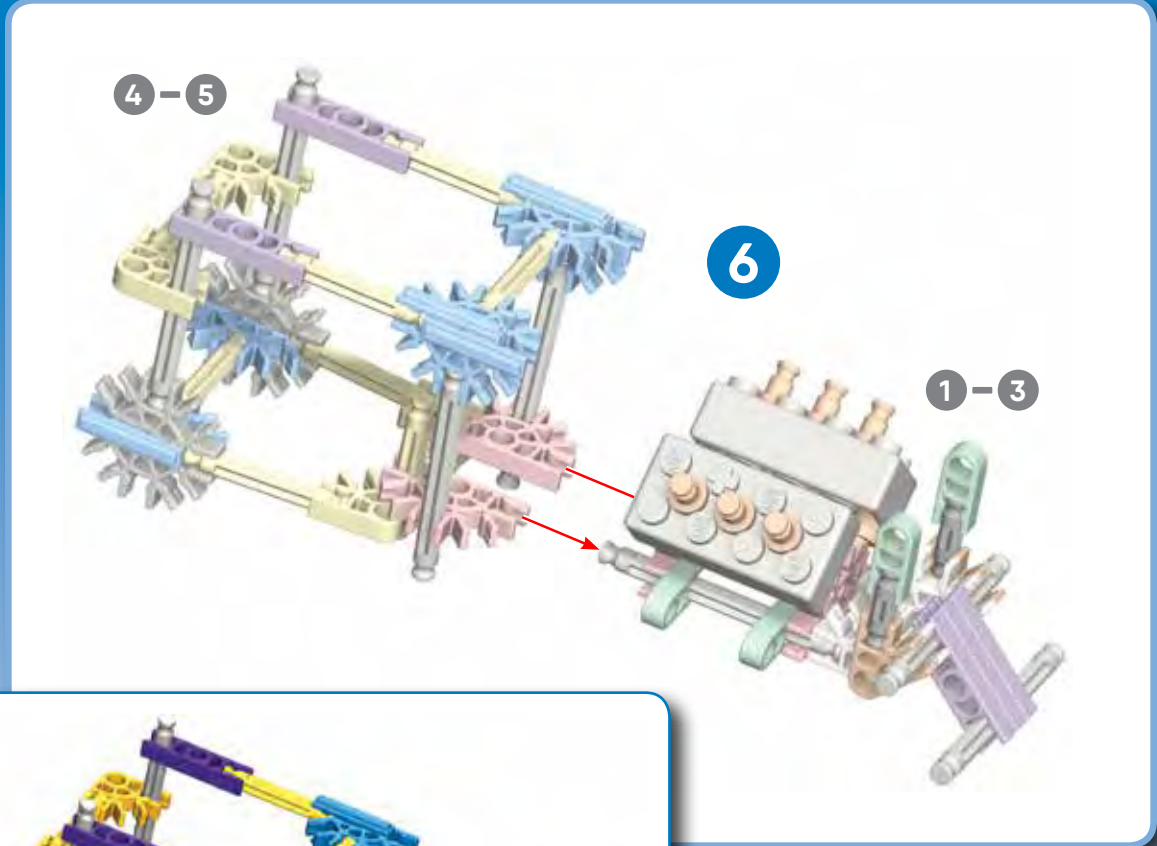

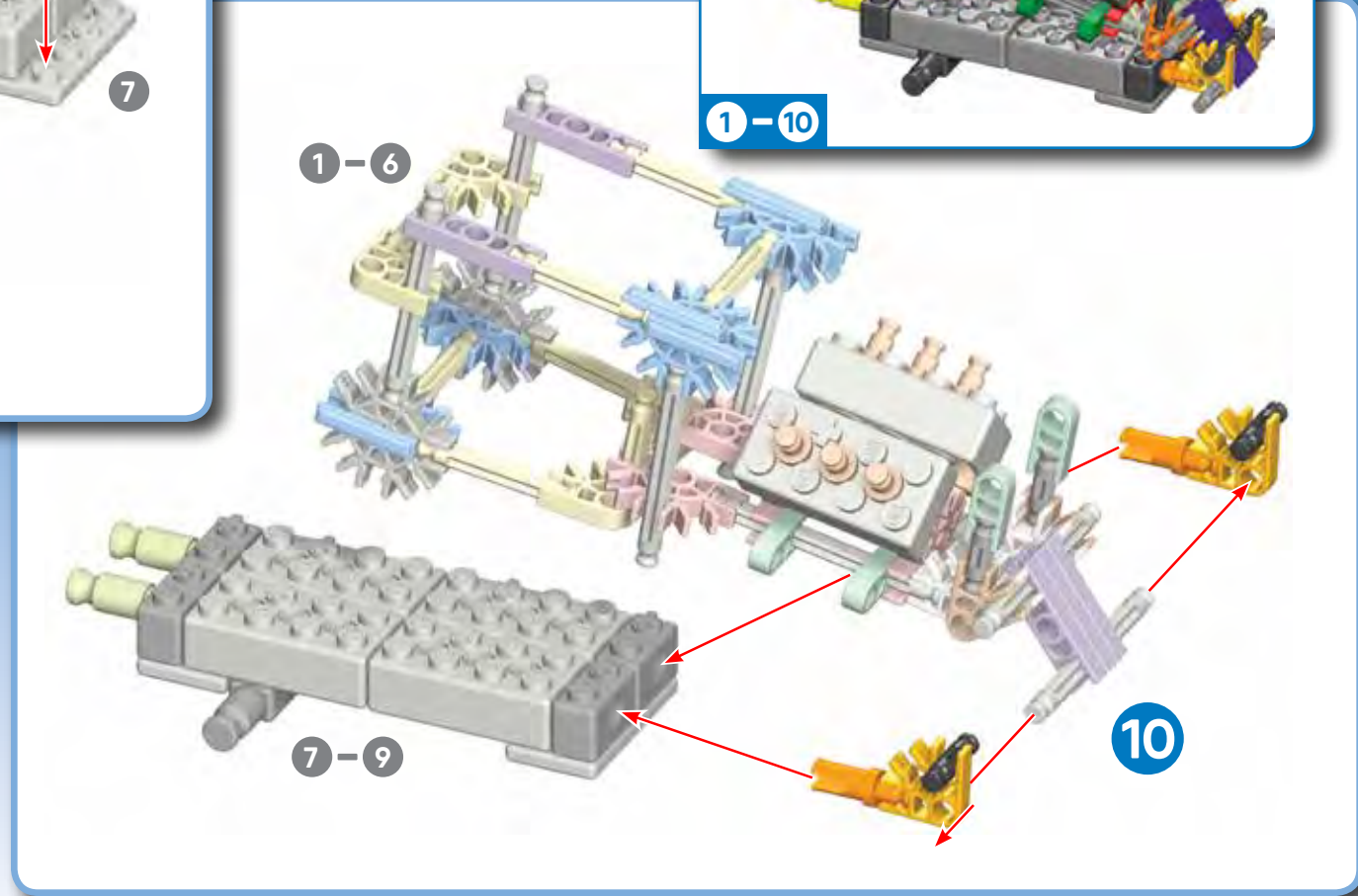
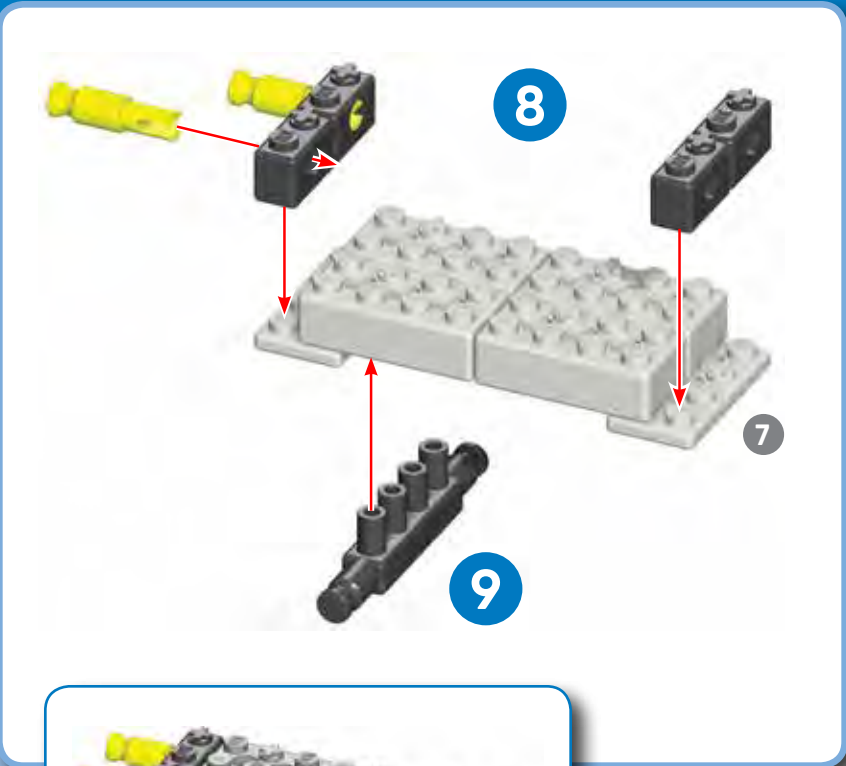

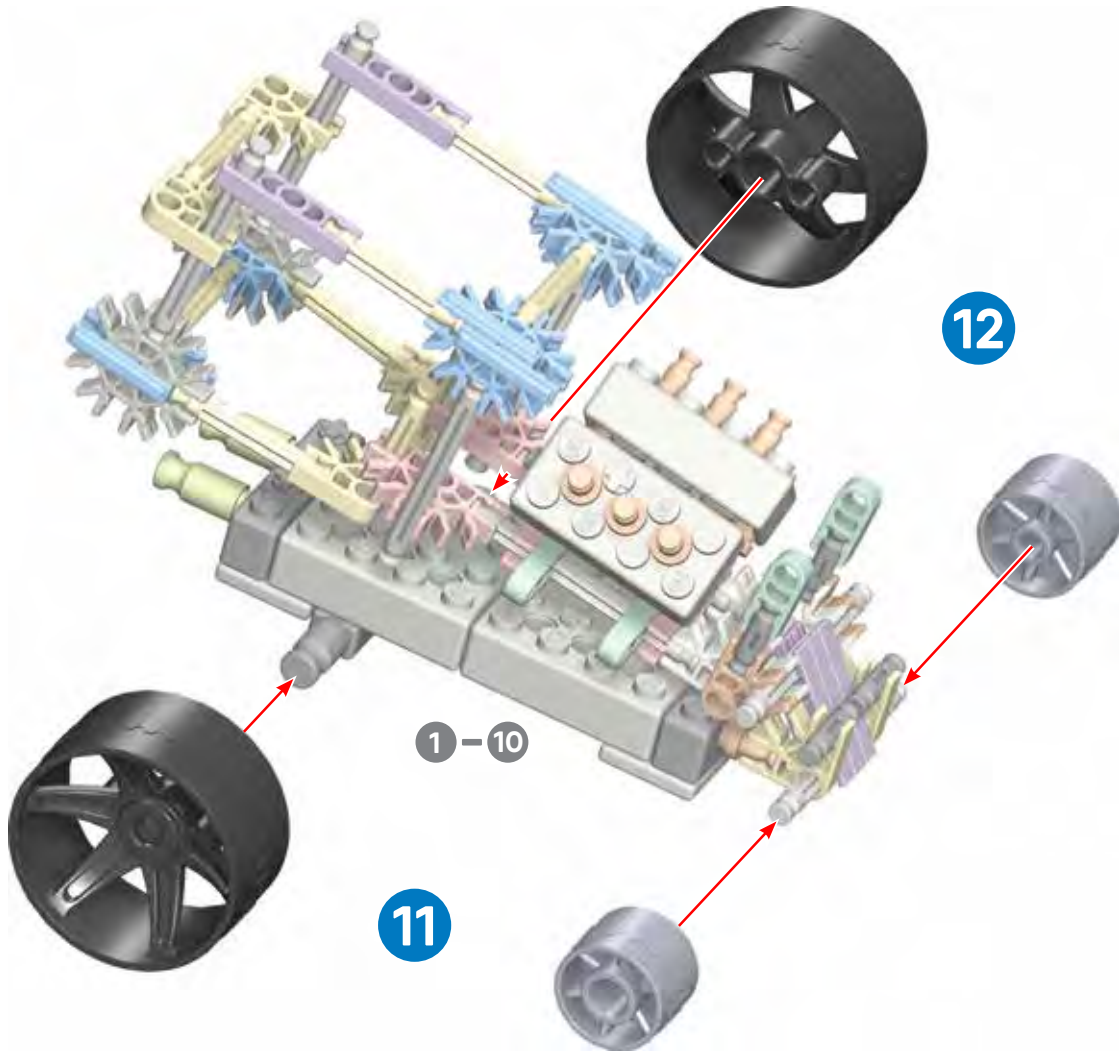



Ferris Wheel
Grande Roue
Rueda de Ferris

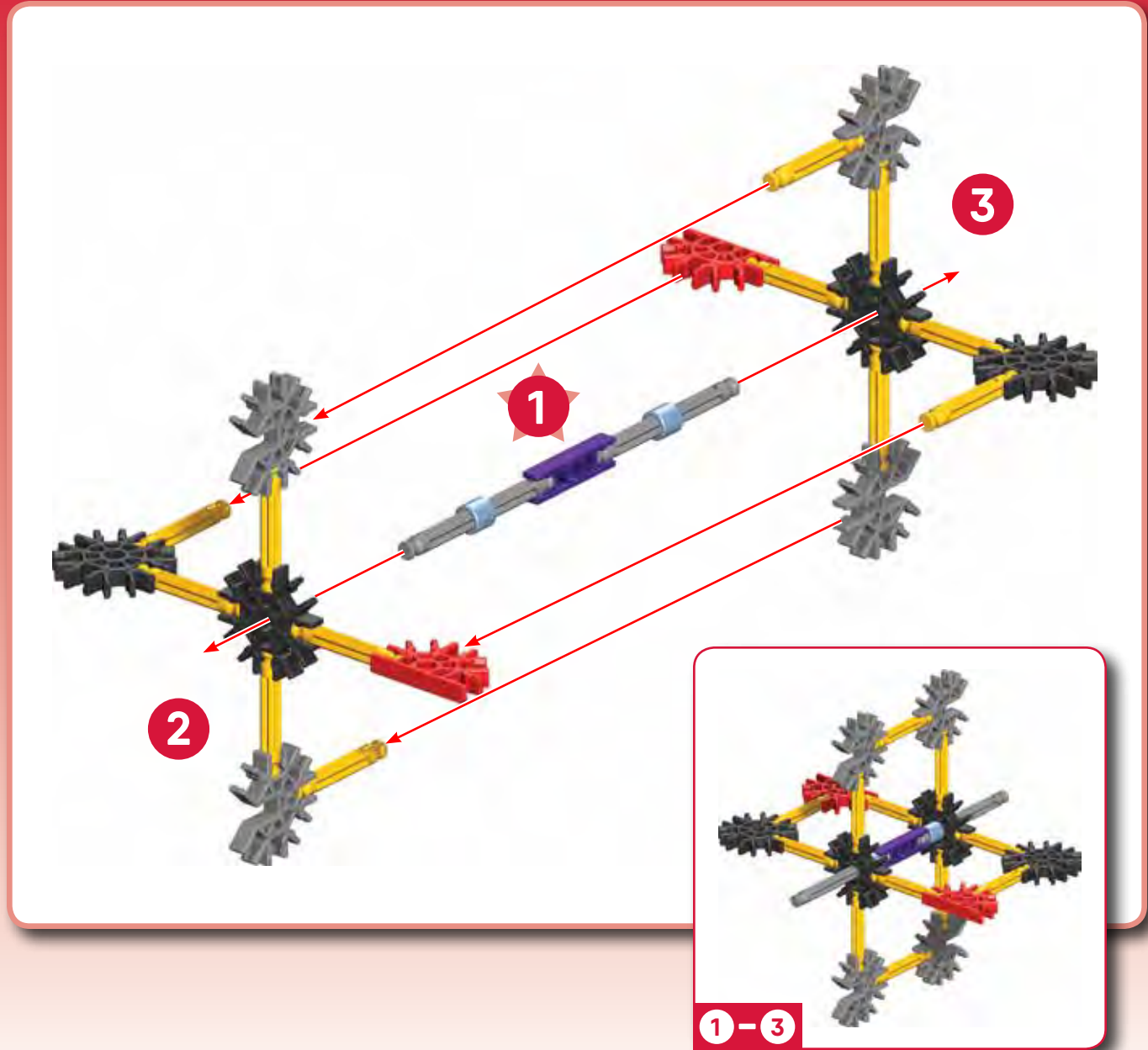

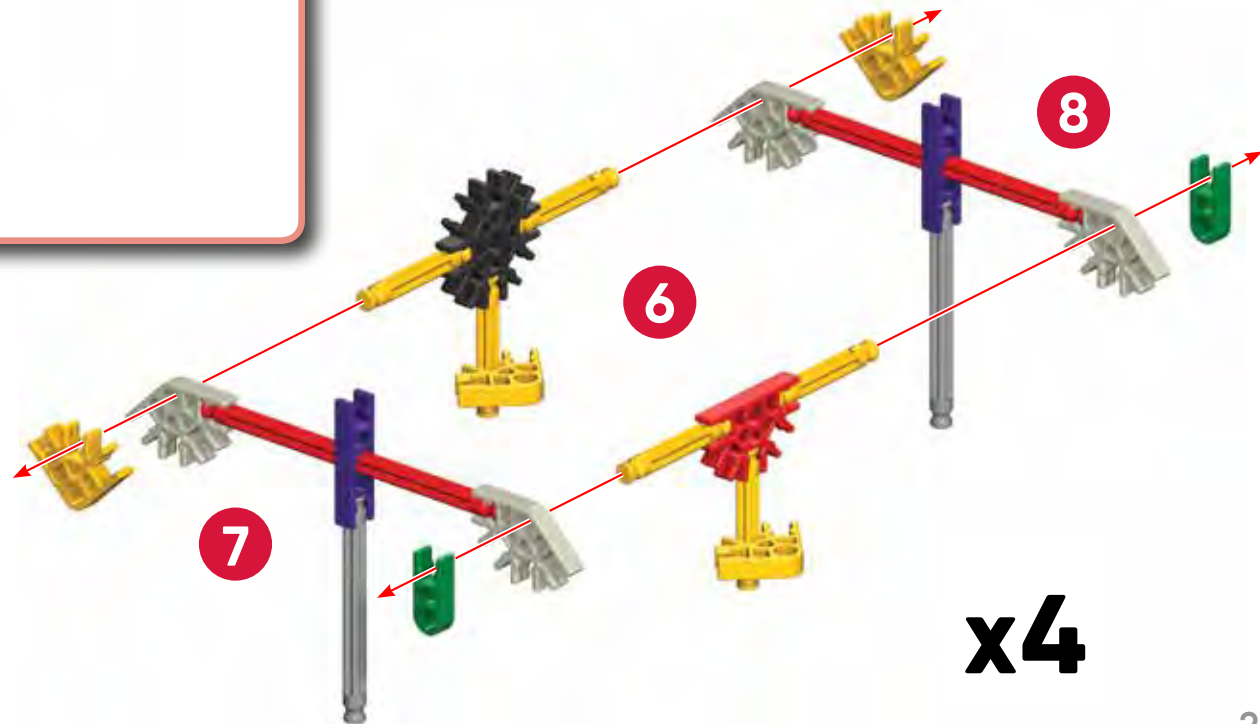
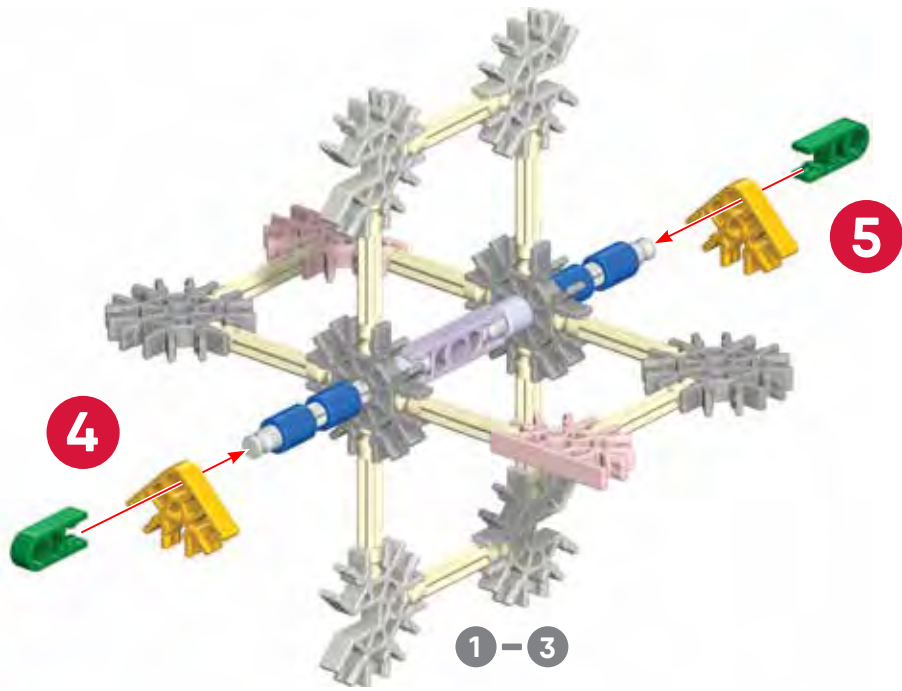

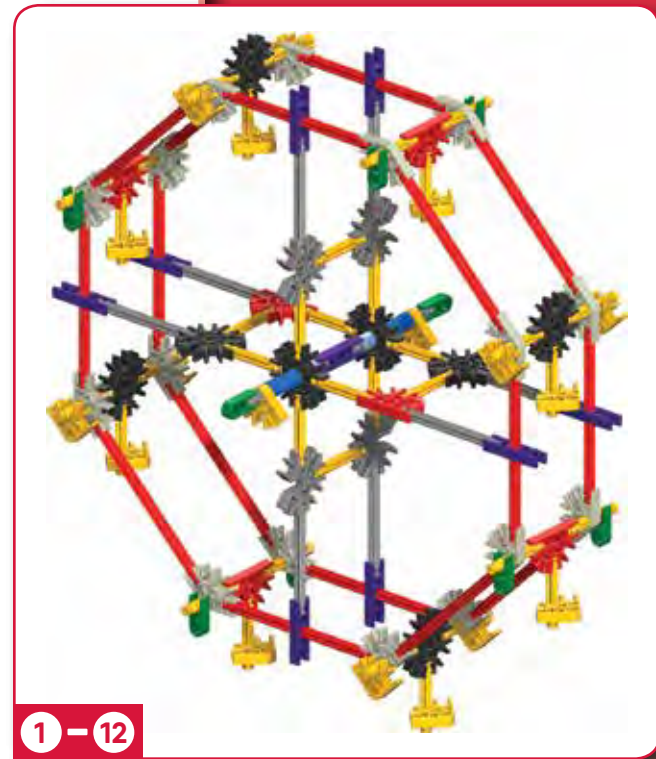
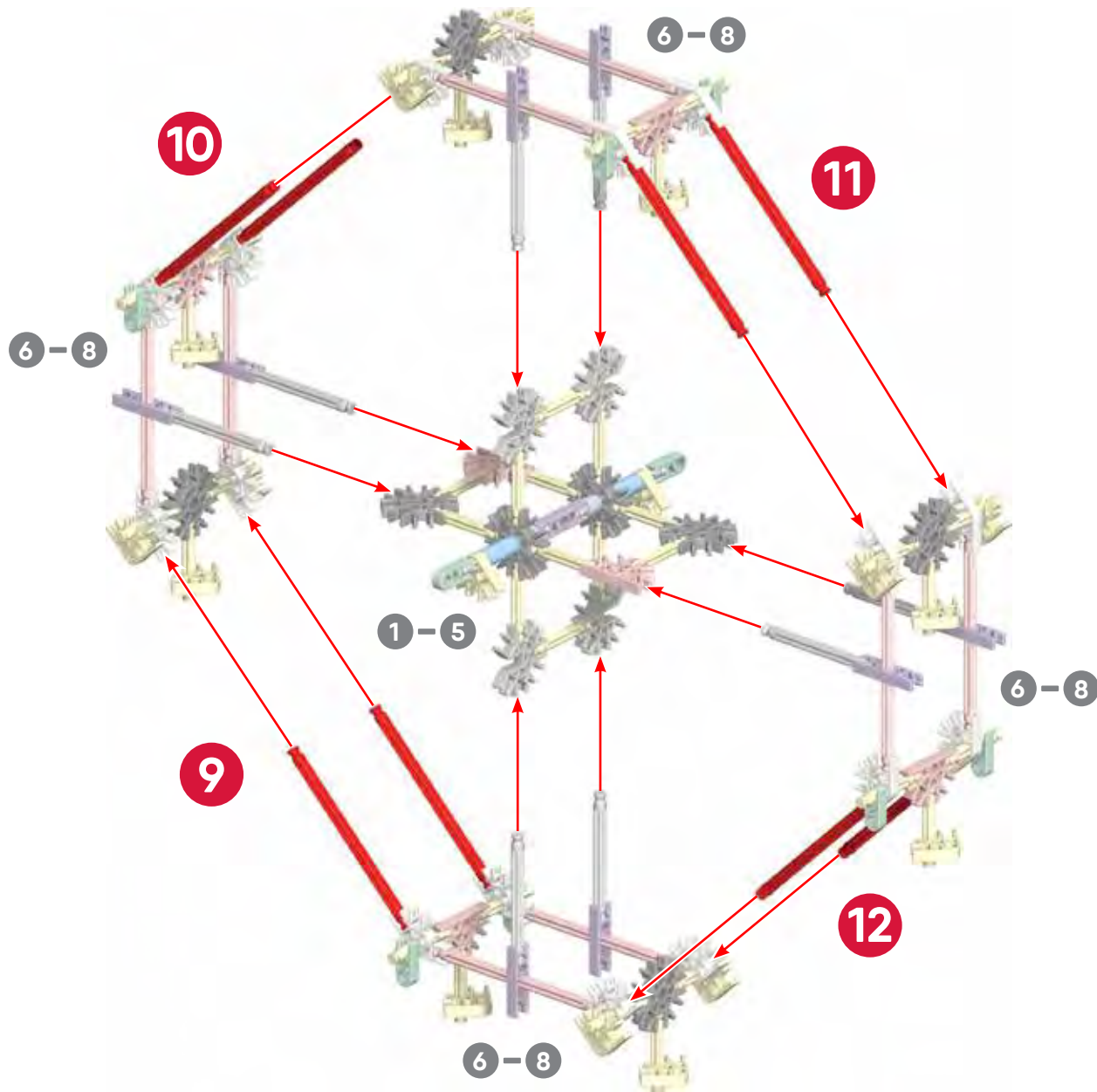

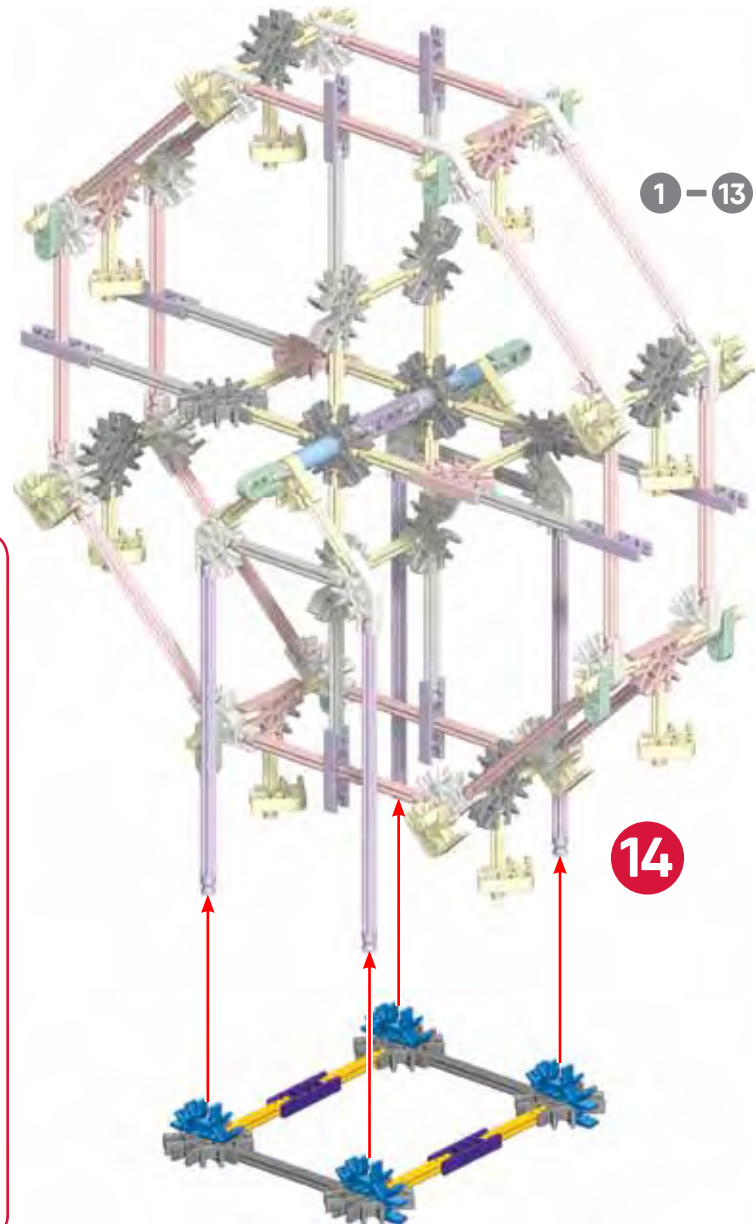
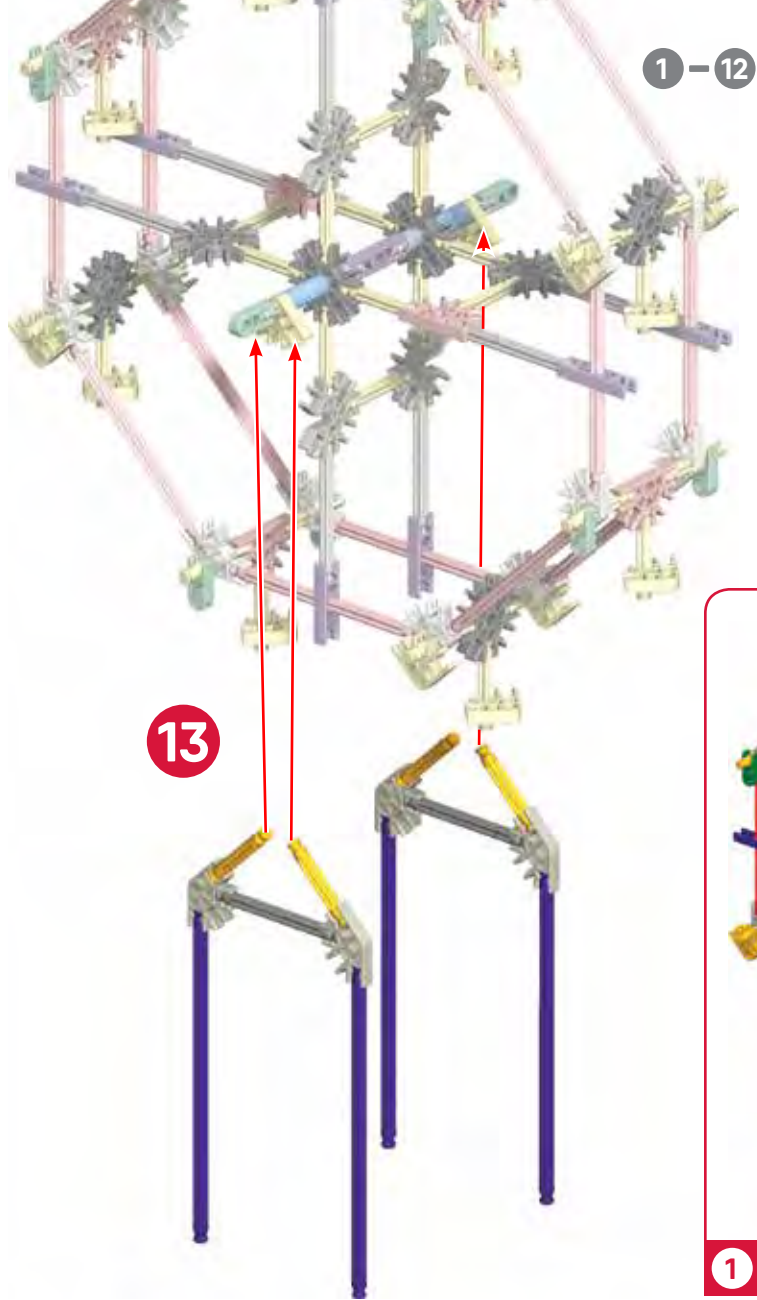

Find **25** more BUILDING IDEAS at
www.knex.com/instructions
and enter code **17520**.

Trouver **25** plus D'IDÉES DE CONSTRUCTION
à www.knex.com/instructions
et appuyez le code **17520**.



(ES) **Español**

(Página 2)

Básicos de Construcción

Empieza a construir

Cada K'NEX pieza tiene su propia forma y color. Mientras construyes, trata de colocar tu modelo en la misma dirección que se muestra en las instrucciones. Los colores desteñidos muestran que esta sección ya está construida.

Conectores

Usted puede deslizar estos conectores especiales juntos. Empuje firmemente hasta que oiga un "clic".

Espaciadores

Asegúrese de usar el color correcto y el número de espaciadores que se muestra en las instrucciones.

Varillas flexibles

Se puede plegar una varilla flexible para hacer formas encorvadas. Será más fácil para conectarla a tu modelo si la doblas varias veces para adelante y atrás.

(Página 3)

Lista de Piezas

Antes de empezar con la construcción, asegúrate de comparar las piezas en tu conjunto con la lista de las piezas aquí. Si faltan algunas, llámanos o escríbenos siguiendo las instrucciones en la página trasera. Estamos aquí para ayudarte.

(Página 26)

IDEAS DE CONSTRUCCIÓN

Para obtener instrucciones de los estos modelos vaya a www.knex.com/instructions y entre en el código **17520**.

(DE) **Deutsch**

(Seite 2)

Grundlegende Bauanleitungen für K'NEX

Los geht's mit dem Bauen

Jedes K'NEX Teil hat seine eigene Form und Farbe. Versuche, dein Modell beim Zusammenbauen so zu orientieren, dass es in die gleiche Richtung weist, wie es in den Anleitungen beschrieben und gezeigt wird. Blasse Farben weisen darauf hin, dass dieser Streckenabschnitt bereits zusammengebaut ist.

Verbindungsstücke

Verbindungsstücke haben besonders lange Schlitz. Achte beim Aneinanderfügen dieser Teile darauf, dass du ein Klickgeräusch hörst.

Abstandsstücke

Achte darauf, die richtige Farbe und Anzahl von Abstandsstücken wie in der Anleitung gezeigt zu verwenden.

Flexi-laschen

Eine Flexi-Lasche ist eine Lasche, die du zu einer Kurve zurechtbiegen kannst. Sie lassen sich leichter an dein Modell anschließen, wenn du sie mehrmals hin- und herbiegst, um sie flexibler zu machen, bevor du sie das erste Mal benutzt.

(Seite 3)

Teilleiste

Bevor du mit dem Bauen anfängst, solltest du prüfen ob die Teile in deinem Bausatz mit denen auf dieser Teilleiste übereinstimmen. Falls etwas fehlt, rufe uns an oder schreibe uns (siehe Rückseite). Wir sind für dich da!

(Seite 26)

BAUVORSCHLÄGE

Für Anweisungen dieser Modelle gehen sie zu www.knex.com/instructions und geben sie Code **17520** ein.

(IT) **Italiano**

(Pagina 2)

Istruzioni di base per costruire con K'NEX

Comincia a costruire

Ogni K'NEX pezzo ha una sua forma e un suo colore. Cerca di tenere il modello nella stessa direzione della figura e in tal modo sarà più semplice allegare i pezzi nei posti giusti. I colori spenti ti dicono che questa sezione è già stata costruita.

Connettori

È molto importante posizionare i connettori in una specifica direzione. Spingi con forza fino ad udire un clic.

Spaziatori

Accertati che usate il colore corretto e il numero di spaziatori mostrati nel' istruzioni.

Aste flessibili

Un'asta flessibile può essere piegata per fare le curve. Sarà più facile attaccarla al modello se prima la pieghi per alcune volte.

(Pagina 3)

Elenco delle parti

Prima di cominciare a costruire, accertati di confrontare le parti che sono nel tuo set con l'elenco delle parti qui. Se ne manca una chiamaci o scrivici usando le informazioni che sono nella retrocopertina. Noi siamo qui per aiutarvi!

(Pagina 26)

IDEE DI COSTRUZIONE

Per istruzioni di questi modelli vai a www.knex.com/instructions inserire il codice **17520**.

(PT) **Português**

(Página 2)

Pontos básicos para a construção K'NEX

Inicia a construção

Cada K'NEX peça tem a sua própria forma definida e cor. Enquanto estás a montar as peças, tenta manter o teu modelo na mesma direcção, conforme mostrado na ilustração, para assim conectar as peças correctamente. As cores desbotadas indicam que esta secção já está construído.

Conectores

Empurre estes conectores especiais juntos firmemente até ouvir um "clicque".

Espaçadores

Existirão certos pontos no teu modelo que necessitam a colocação de espaçadores. Certifique-se de contar com cuidado.

Varetas flexíveis

Uma vareta flexível é uma vareta que podes dobrar para formar curvas. Para montares no teu modelo, será mais fácil se dobrares primeiro a vareta para trás e para a frente.

(Página 3)

Lista de peças

Antes de iniciares a construção, certifica-te de que comparas as peças do teu conjunto com a lista das peças aqui. Se está desaparecido uma peça telefona ou escreve-nos usando as informações indicadas na contracapa. Estamos aqui para te ajudar!

(Página 26)

IDEIAS DE CONSTRUÇÃO

Para obter instruções destes modelos vá em www.knex.com/instructions e digite o código **17520**.

(NL) **Nederlands**

(Bladzijde 2)

Basisstappen voor K'NEX bouwen

Begin te bouwen

Elk K'NEX stuk heeft zijn eigen vorm en kleur. Tracht je model in dezelfde richting te plaatsen als de aanwijzingen terwijl je bouwt en monteert. De vervaagde kleuren duiden aan dat dit deel reeds is opgebouwd.

Verbindingsstukken

Duw deze speciale verbindingstukken stevig tegen elkaar aan tot je een 'klik' hoort.

Afstandhouders

Zorg dat je het juiste en kleur aantal afstandhouders gebruikt.

Flexi-rods

Een Flexi-rod is een stang die kan gebogen worden om bochten of curves te maken. Ze maken zich gemakkelijker vast aan je model wanneer je ze eerst een paar keer heen en weer buigt.

(Bladzijde 3)

Lijst met onderdelen

Zorg ervoor dat de onderdelen te vergelijken met de onderdelen hier op te sommen. Als er iets is ontbreekt, bel of schrijf ons gebruik van de informatie op de achterkant. Wij zijn hier om u te helpen!

(Bladzijde 26)

BOUWIDEEËN

Voor instructies van deze modellen naar www.knex.com/instructions en vul de code **17520**.



BUILDER'S CHOICE
Building Set

CHOIX DU CONSTRUCTEUR
Jeu de construction

knex.com

facebook.com/knex

@knexbrands



©2017 K'NEX Limited Partnership Group, P.O. Box 700, Hatfield, PA 19440-0700; 1-800-KID-KNEX (USA/Canada/États-Unis/EE.UU.); email@knex.com; knex.com. K'NEX UK Ltd, 200 Brook Drive, Green Park, Reading, RG6 2UB England; K'NEX France, 24 rue du Quatre Septembre, 75002 Paris, France. For customers outside the USA/Canada please contact your local distributor at www.knex.com/distributors.

(FR) Pour les clients en dehors du Canada et des États-Unis, veuillez contacter votre distributeur local que vous pouvez trouver sur www.knex.com/distributors.

(ES) El cliente que no vive en EE.UU./Canadá se pone en contacto con el distribuidor local. Encuentre la información para el distribuidor local en www.knex.com/distributors.

(EN) K'NEX is a registered trademark and Imagine is a trademark of K'NEX Limited Partnership Group.
(FR) K'NEX est une marque déposée et Imagine est une marque de K'NEX Limited Partnership Group.
(ES) K'NEX es una marca registrada y Imagine es una marca de K'NEX Limited Partnership Group.

(EN) Product & colors may vary. Most models can be built one at a time.

(FR) Le produit et ses couleurs peuvent varier. Les différents modèles ne peuvent être construits qu'un par un.

(ES) El producto y los colores pueden variar. La mayoría de los modelos se pueden construir uno a la vez.

(DE) Produkte und Farben können abweichen. Die meisten Modelle können immer nur einzeln gebaut werden.

(IT) Prodotti e colori possono differire. La maggior parte dei modelli si può costruire autonomamente. Istruzioni accluse.

(PT) O produto e as cores podem variar. A maioria dos modelos pode ser montado um de cada vez.

(NL) Product en kleuren kunnen variëren. De meeste modellen kunnen uitsluitend een voor een worden gebouwd.

****Sold separately**

Vendus séparément

Se venden por separado

Separat erhältlich

Venduti separatamente

Vendidos separadamente

Afzonderlijk verkrijgbaar

117520-V1-5/17