

K'nex

AGES/ÂGE/EDADS

5+

15210

Beginner 40 Model
Building Set
Modèle Débutant 40
Jeu de construction

40 BUILDS
MODÈLES*

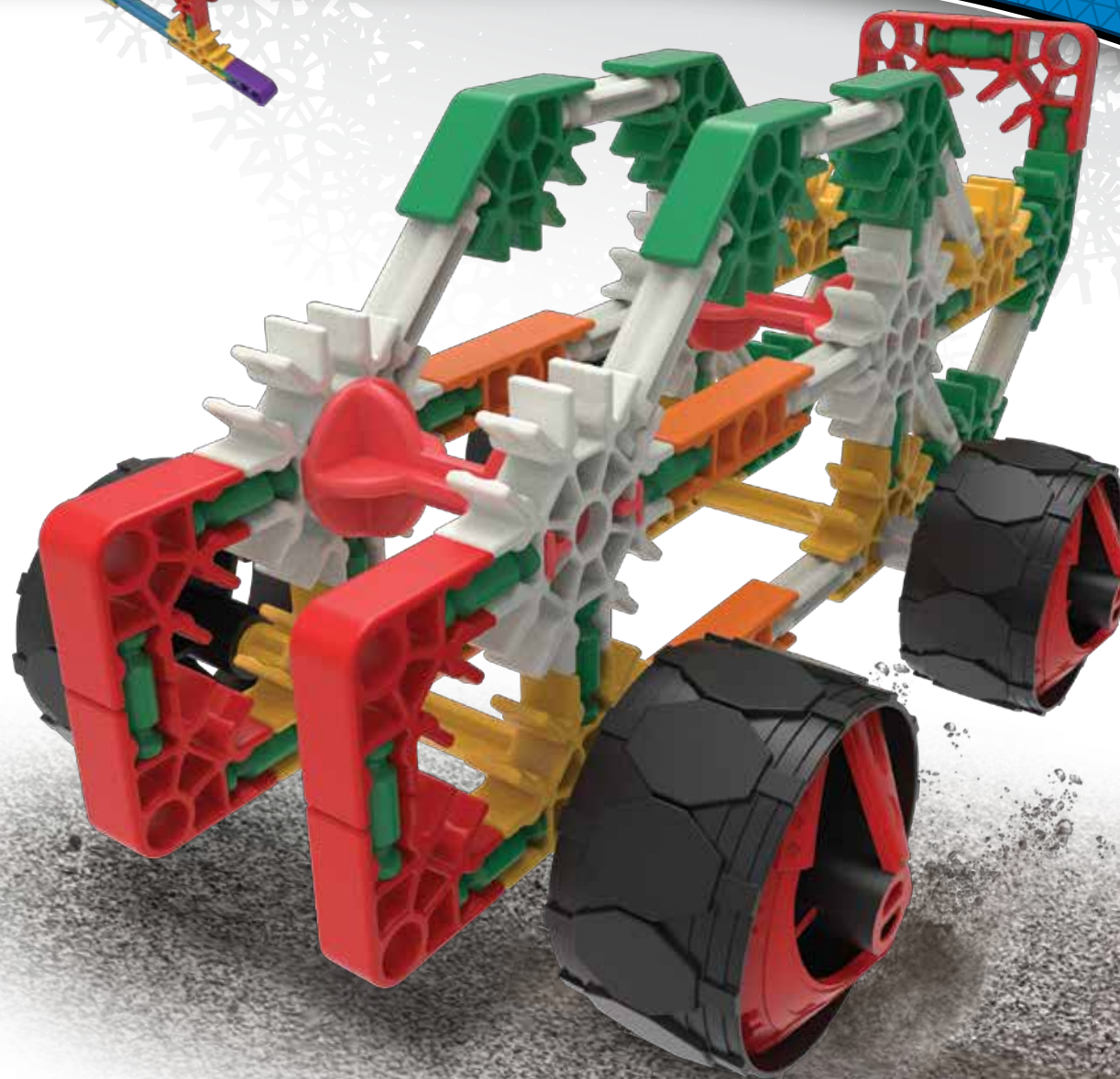

⚠ WARNING:

CHOKING HAZARD – Small parts.
Not for children under 3 years.

⚠ ATTENTION :

RISQUE D'ÉTOUFFEMENT – Pièces de petite taille.
Ne convient pas aux enfants de moins de 3 ans.

Beginner 40 Model Building Set

Modèle Débutant 40
Jeu de construction

(EN) English

CONTENTS

BASIC SHAPES 3
 TRIANGLES 4
 ARROWS 5
 DINOSAUR 6
 HANG GLIDER 8
 CUBE 10
 CAR 11
 SAILBOAT 14
 SCOOTER 16
 SKYSCRAPER 18
 AIRPLANE 20

(FR) Français

CONTENU

FORMES DE BASE 3
 TRIANGLES 4
 FLÈCHES 5
 DINOSAURE 6
 DELTAPLANE 8
 CUBE 10
 VOITURE 11
 VOILER 14
 SCOOTER 16
 GRATTE CIEL 18
 AVION 20

(EN) **Building Tips**

(FR) **Conseils De Construction**

Explore connecting these K'NEX pieces. The connection points will be on the inside openings of the connector.

Explorez la connexion de ces pièces K'NEX. Les points de connexion se trouveront sur les ouvertures intérieures du connecteur.

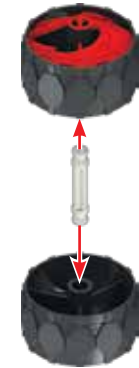
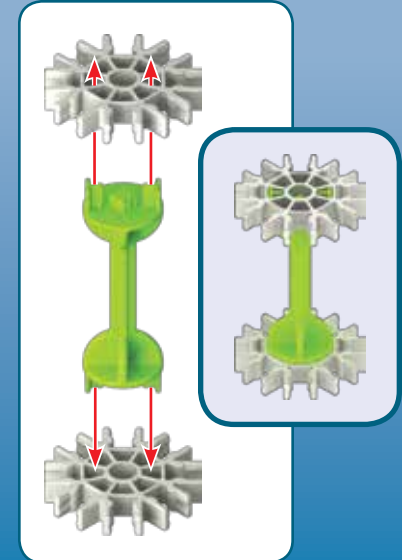
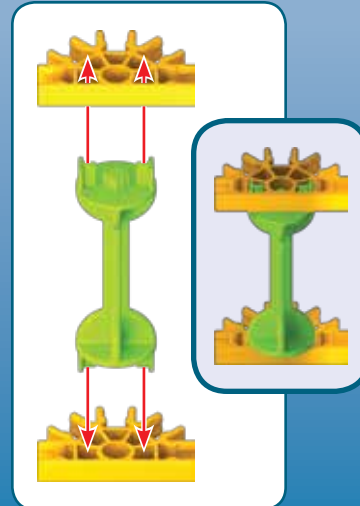
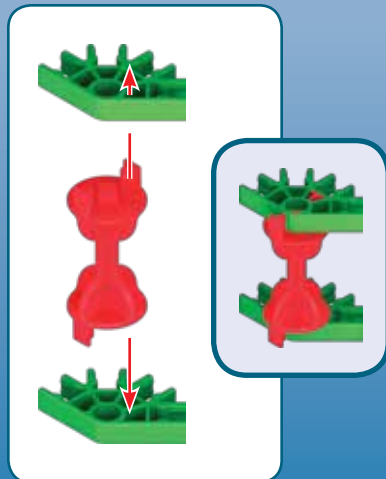
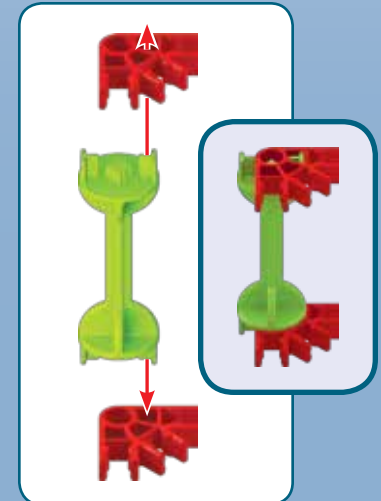
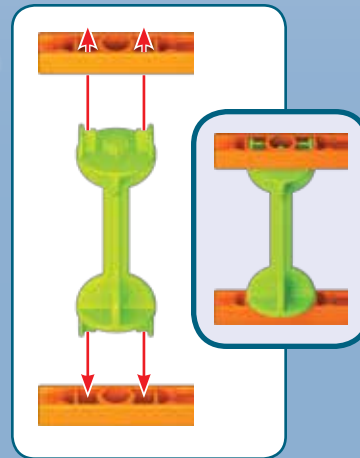
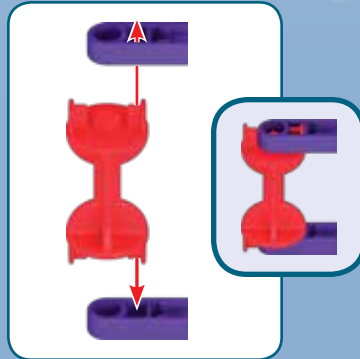

Always push the K'NEX rod firmly into the tire assembly.

Enfoncez toujours fermement la tige K'NEX dans l'ensemble de pneu.



(EN) Parts List

If anything is missing, please visit www.Basicfun.com to contact us. We are here to help you!

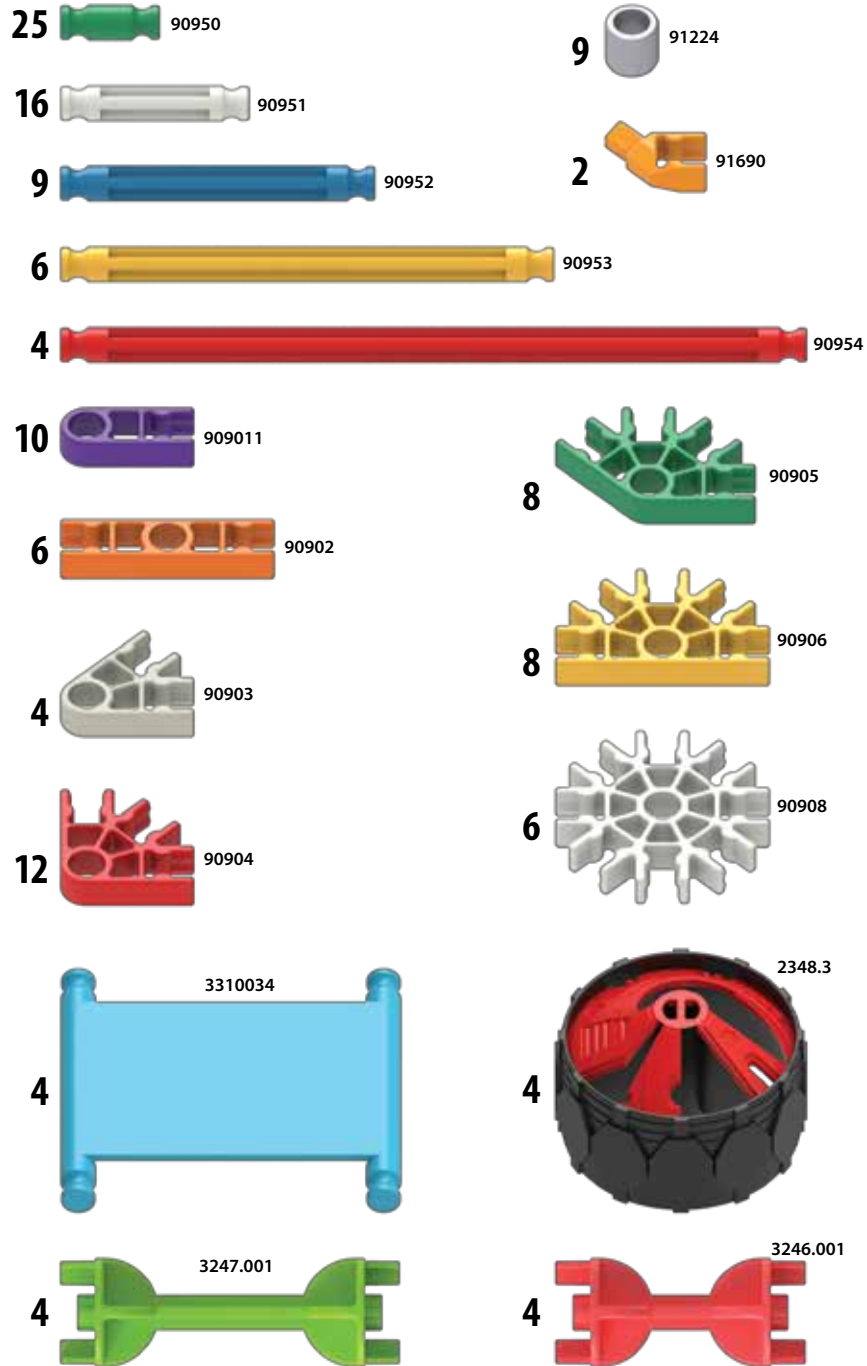

(FR) Liste des Pièces

Si quelque chose manque, veuillez visiter www.Basicfun.com pour nous contacter. Nous sommes là pour vous aider !



(EN) **WARNING:** CHOKING HAZARD – Small parts. Not for children under 3 years.

(FR) **ATTENTION :** RISQUE D'ÉTOUFFEMENT – Pièces de petite taille. Ne convient pas aux enfants de moins de 3 ans.

(ES) **ADVERTENCIA:** PELIGRO DE ASFIXIA – Piezas pequeñas. No para niños menores de 3 años.

(DE) **ACHTUNG:** ERSTICKUNGSGEFAHR – Kleinteile. Nicht geeignet für Kinder unter 3 Jahren.

(IT) **AVVISO:** PERICOLO DI SOFFOCARE – Pezzi piccoli. Non adatto per bambini sotto 3 anni.

(PT) **AVISO:** PERIGO DE SUFOCAÇÃO – Peças pequenas. Não se destina a crianças com menos de 3 anos de idade.

(NL) **WAARSCHUWING:** VERSTIKKINGSGEVAAR – Kleine onderdelen. Niet geschikt voor kinderen jonger dan 3 jaar.

(EN) Practice Makes Perfect

Try building these basic shapes with your K'NEX pieces before you start building your models.

(FR) La Pratique Rend Parfait

Essayez de créer ces formes de base avec vos pièces K'NEX avant de commencer à construire des modèles.

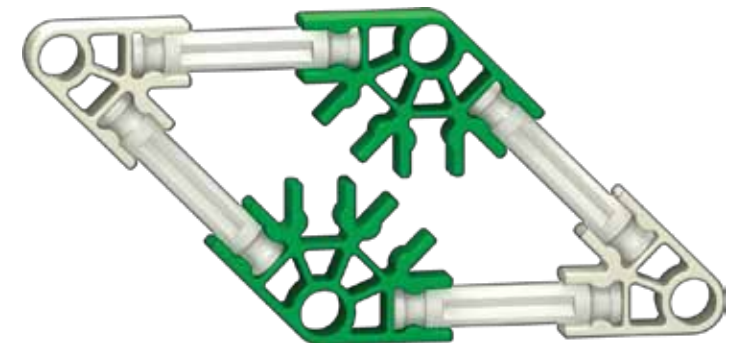
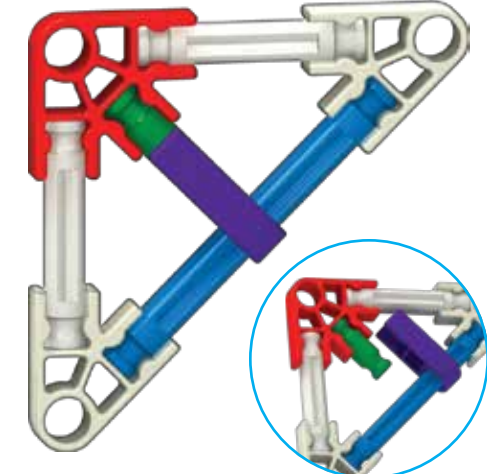
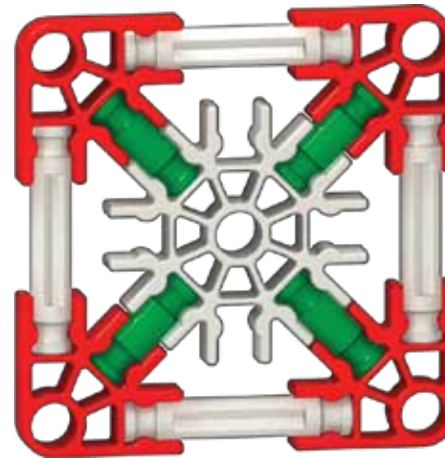

TRIANGLES

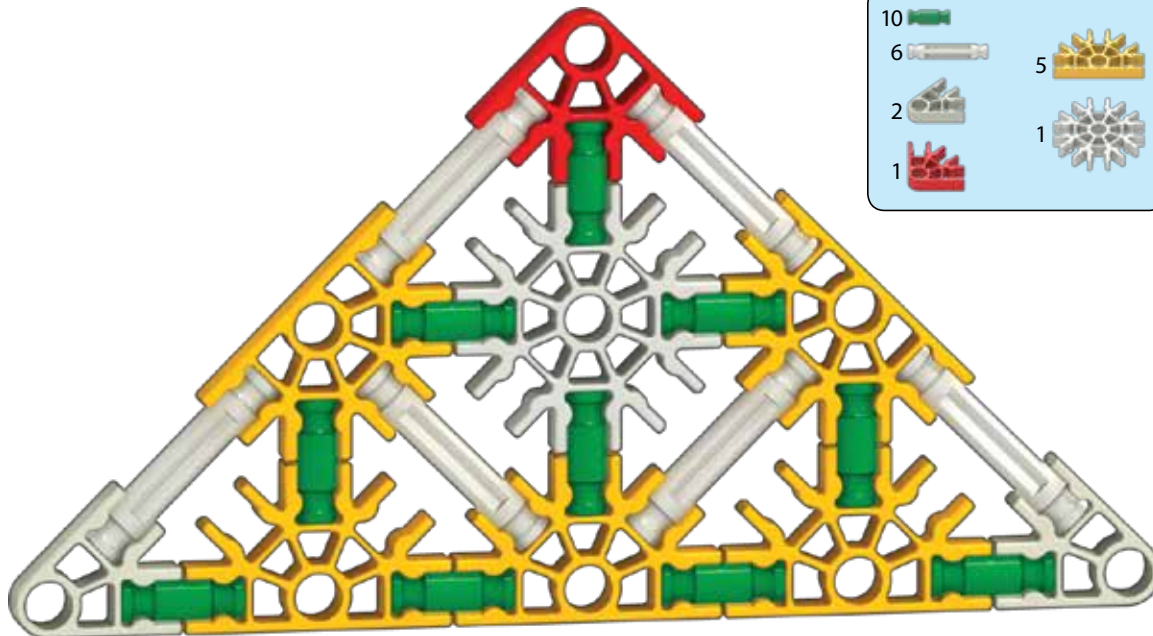
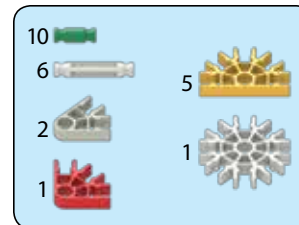
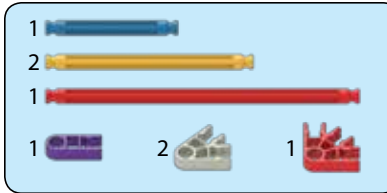





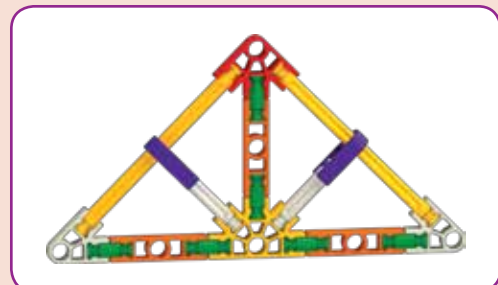



DID YOU KNOW? Many K'NEX pieces can be substituted with other pieces to make the same size shape.

LE SAVIEZ-VOUS? De nombreuses pièces K'NEX peuvent être remplacées par d'autres pour obtenir la même taille.



**ARROWS
FLÈCHES**

**BUILDS 2
CONSTRUIT 2**

- 4  8 
- 4 
- 4  4 
- 10  4 
- 4 

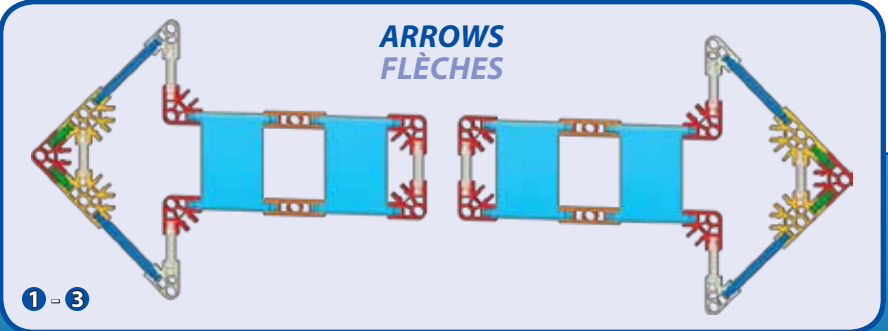
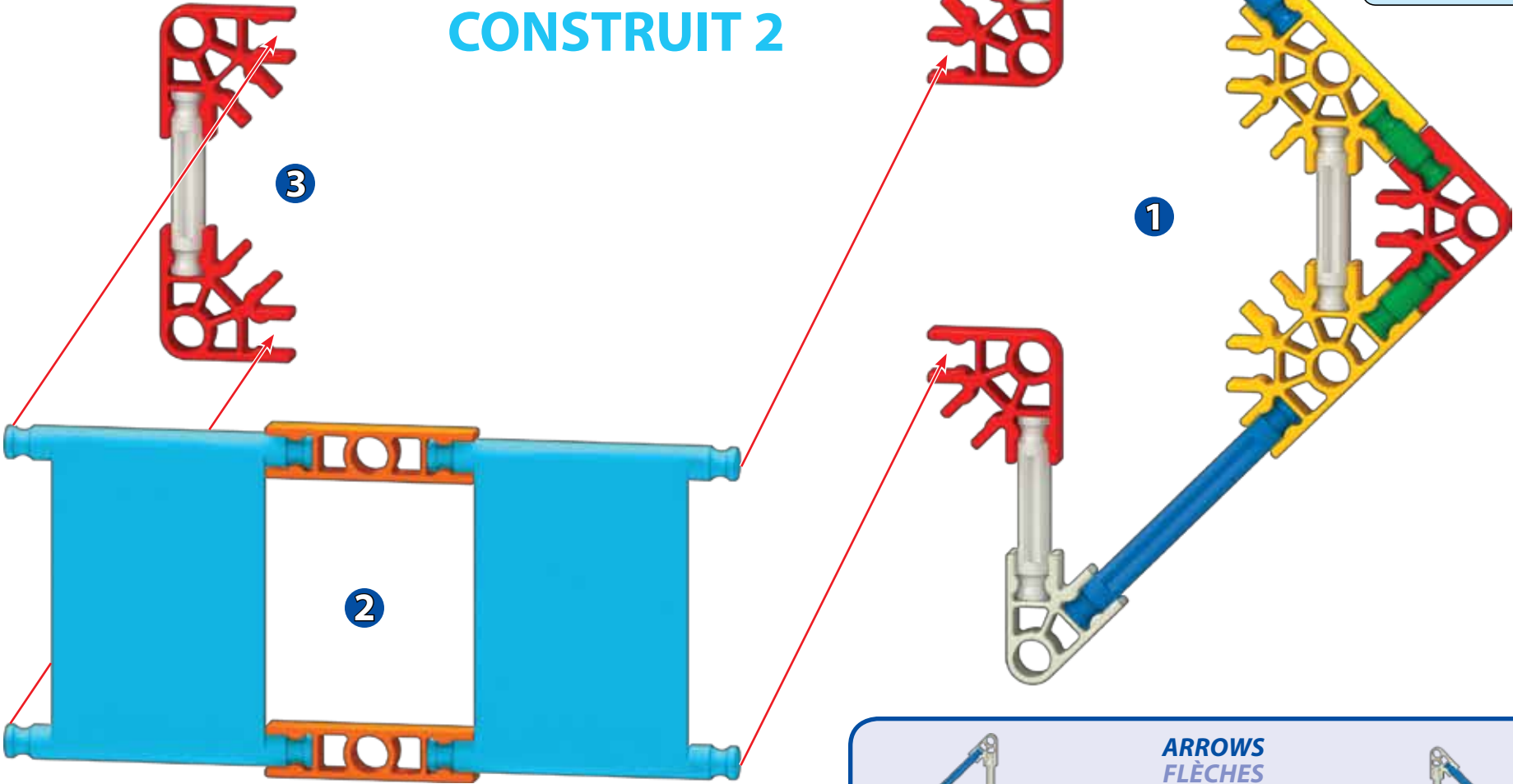

DINOSAUR DINOSAURE

1

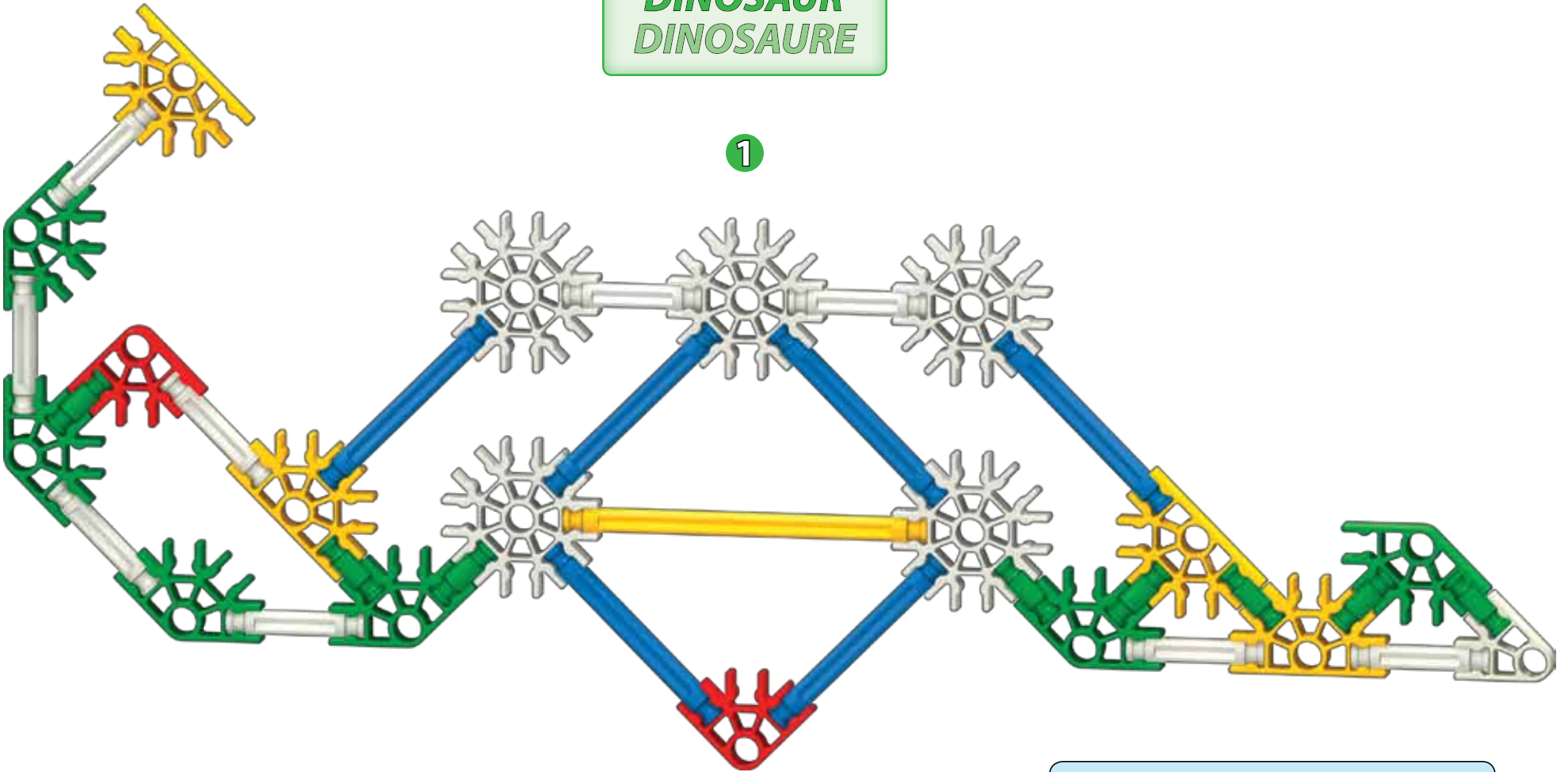

Faded colors show you this section is already built.

Les pièces ayant une couleur estompée sont celles déjà assemblées.

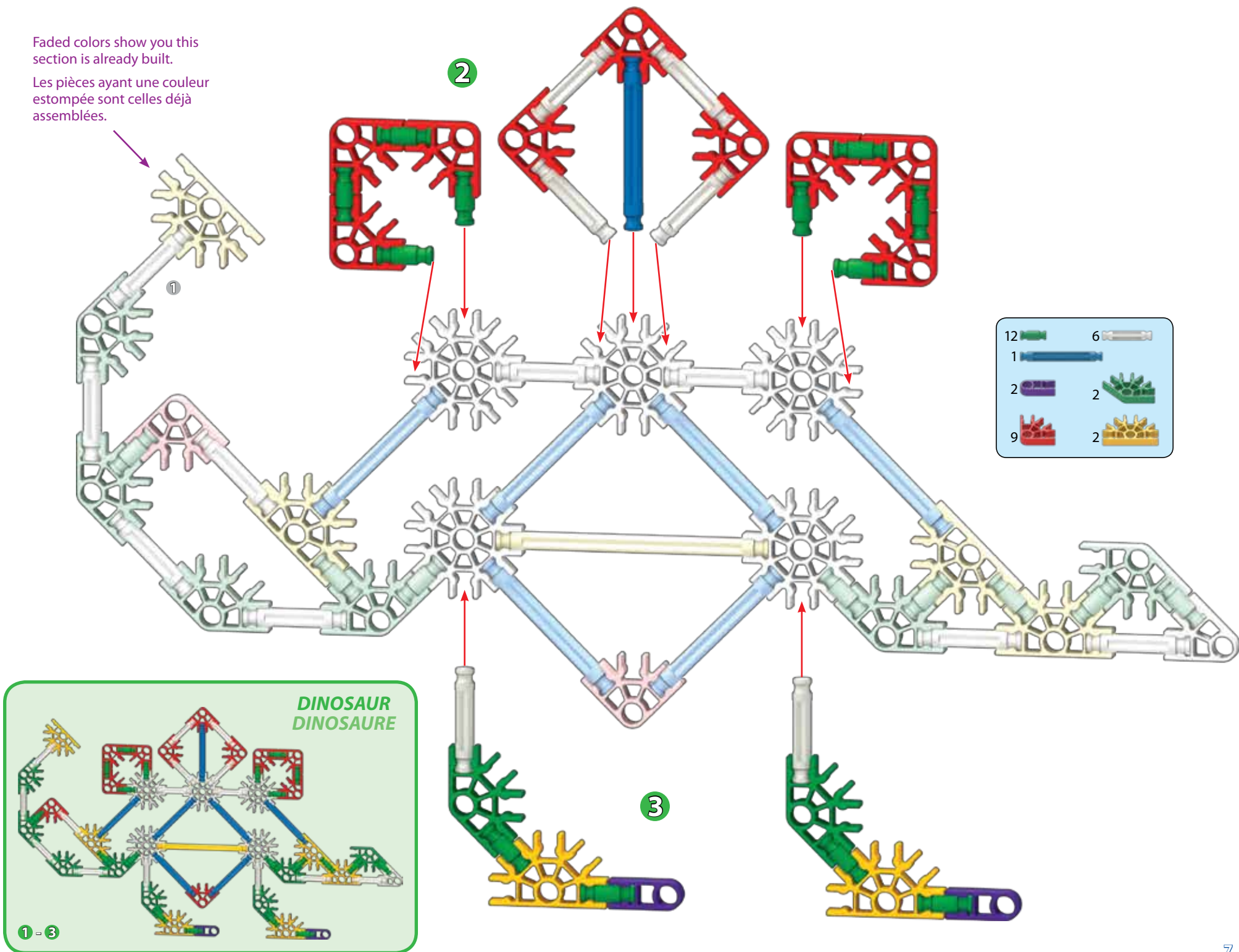

HANG GLIDER DELTAPLANE

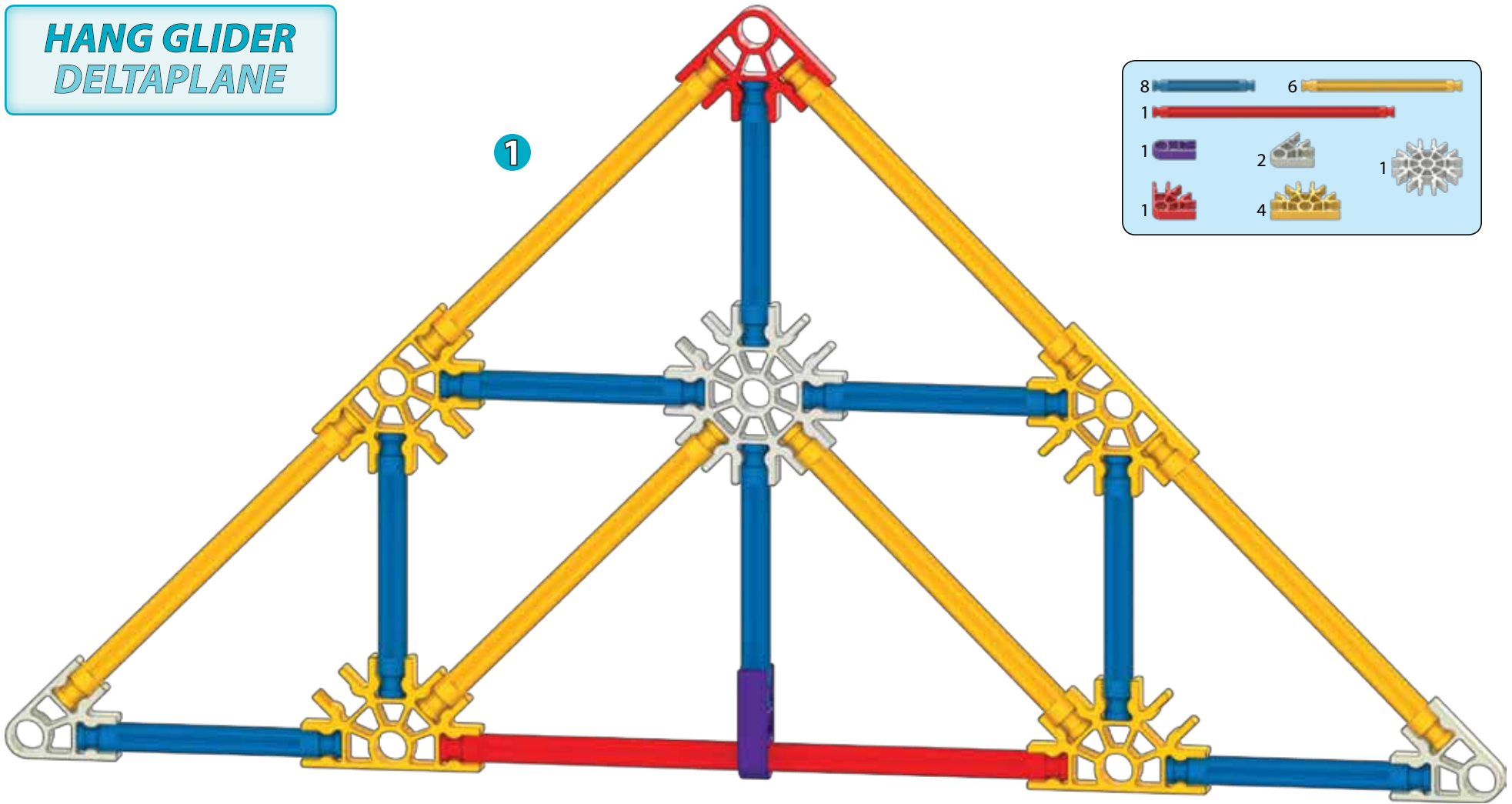

- | | | | |
|---|--|---|--|
| 8 | | 6 | |
| 1 | | | |
| 1 | | 2 | |
| 1 | | 4 | |
| | | 1 | |

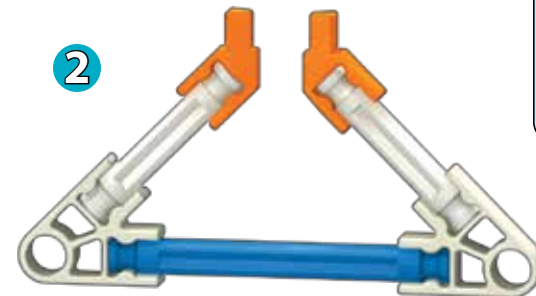

- | | |
|---|--|
| 2 | |
| 1 | |
| 2 | |
| 2 | |

TIP: Try to face your model in the same direction as the instructions while you build.

CONSEIL: essayez d'affronter votre modèle dans le même sens que les instructions pendant la construction.

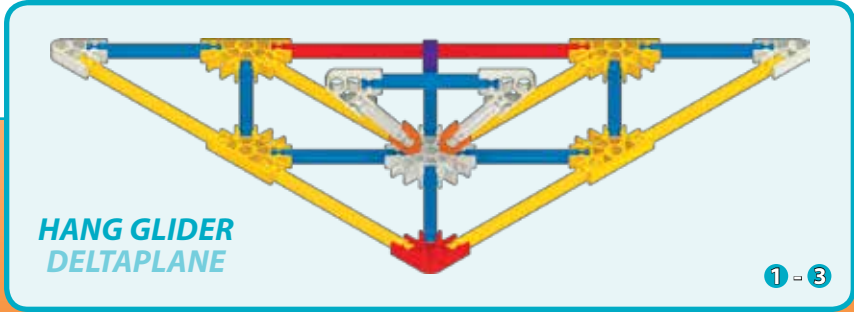
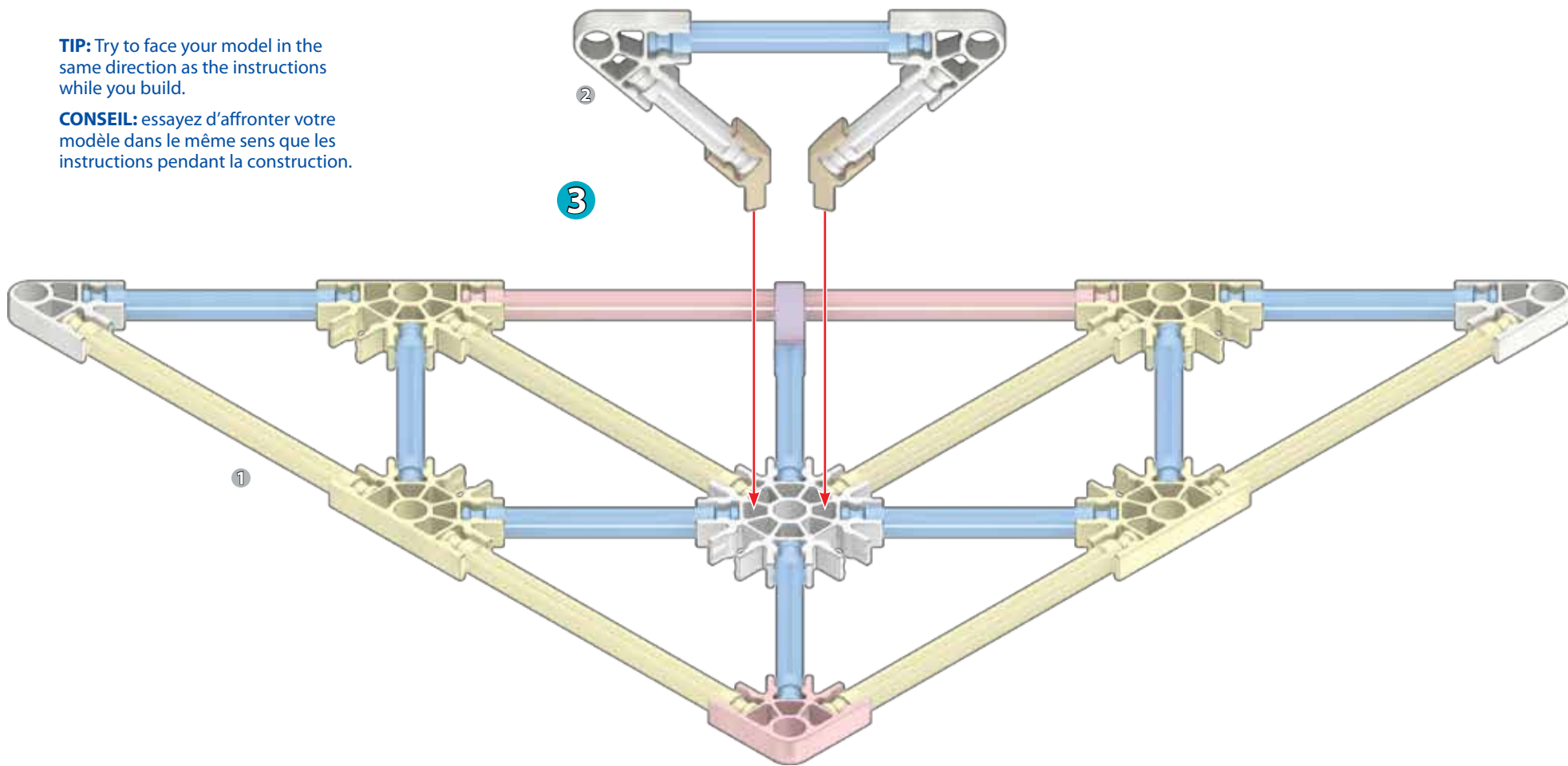

**HANG GLIDER
DELTAPLANE**

CUBE

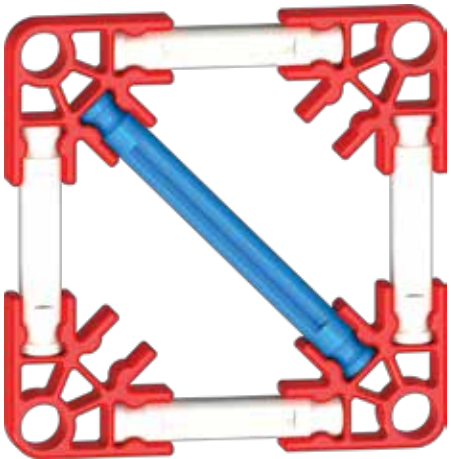

1

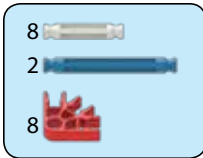
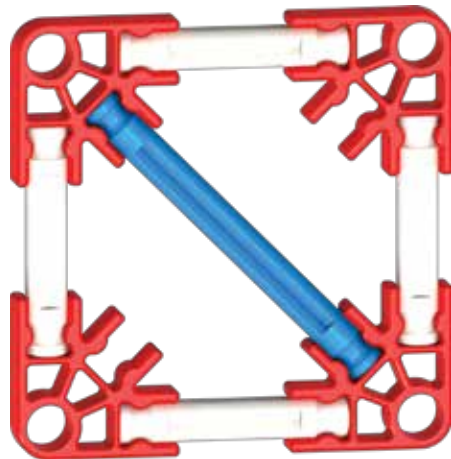

2

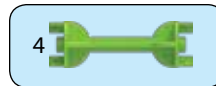
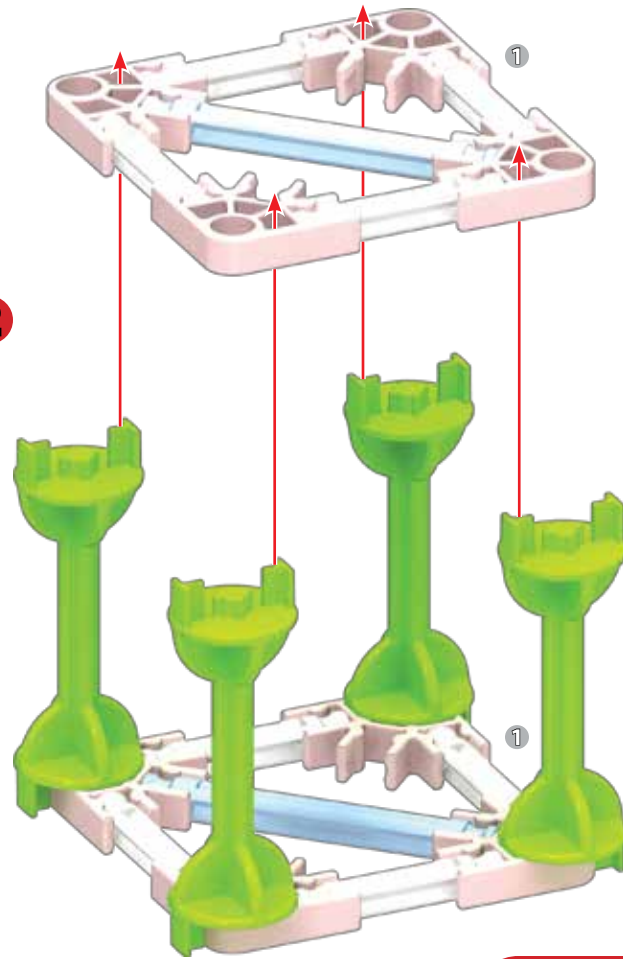

CUBE

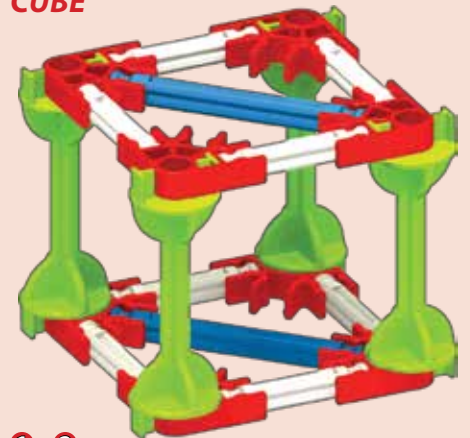

1 - 2

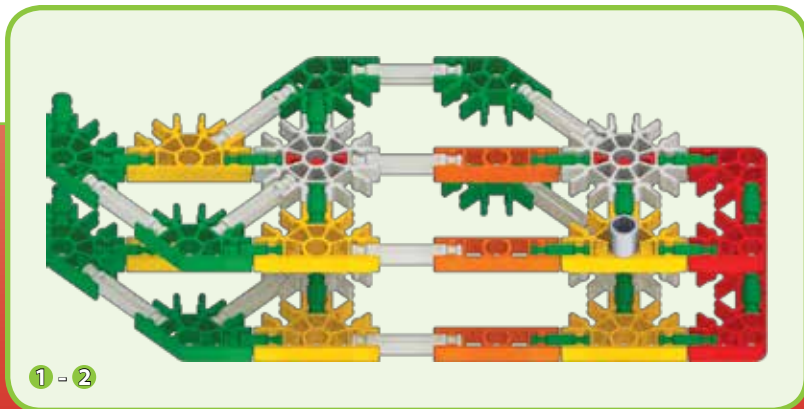
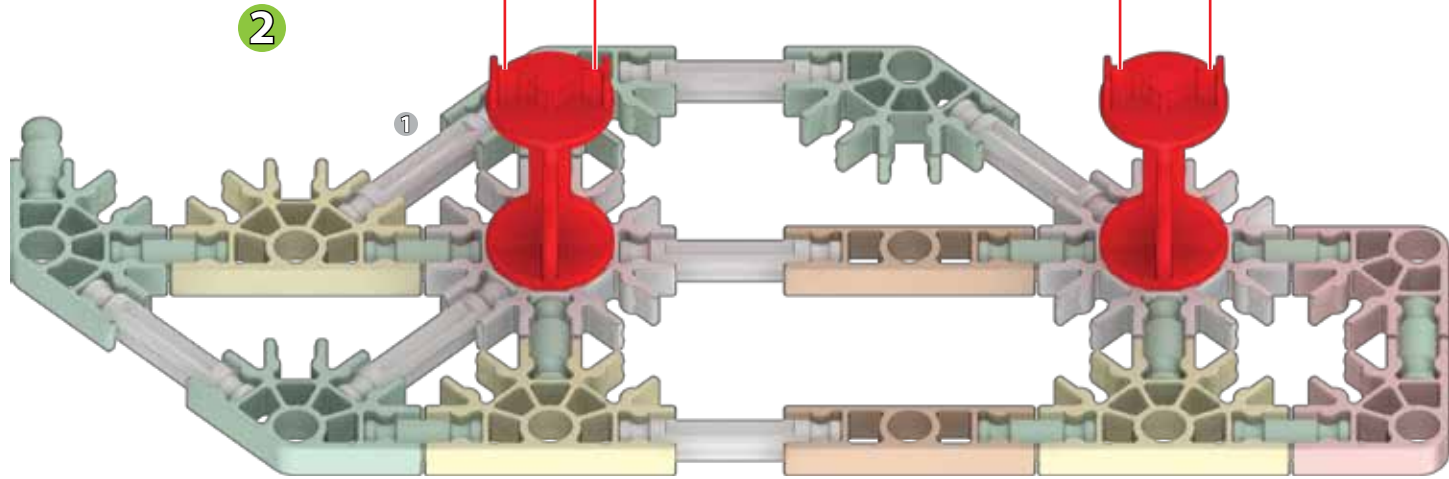
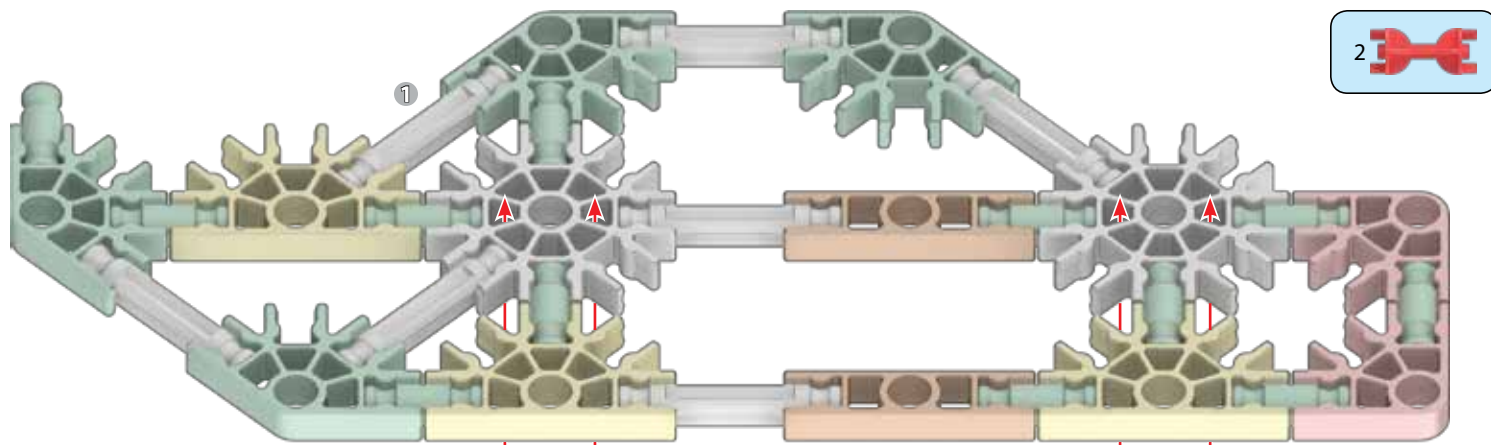

CAR
VOITURE

1 - 5

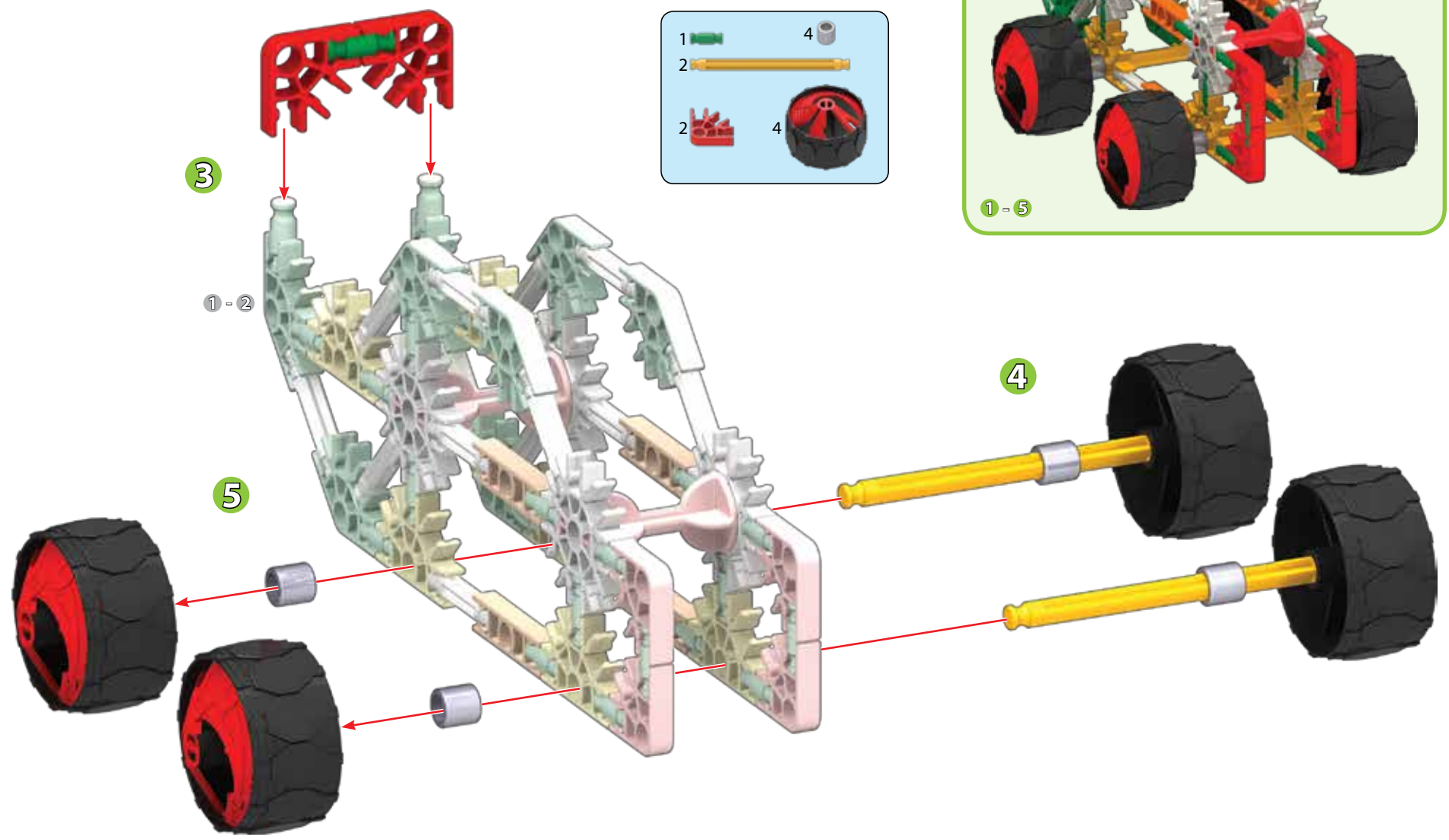

SAILBOAT VOILIER

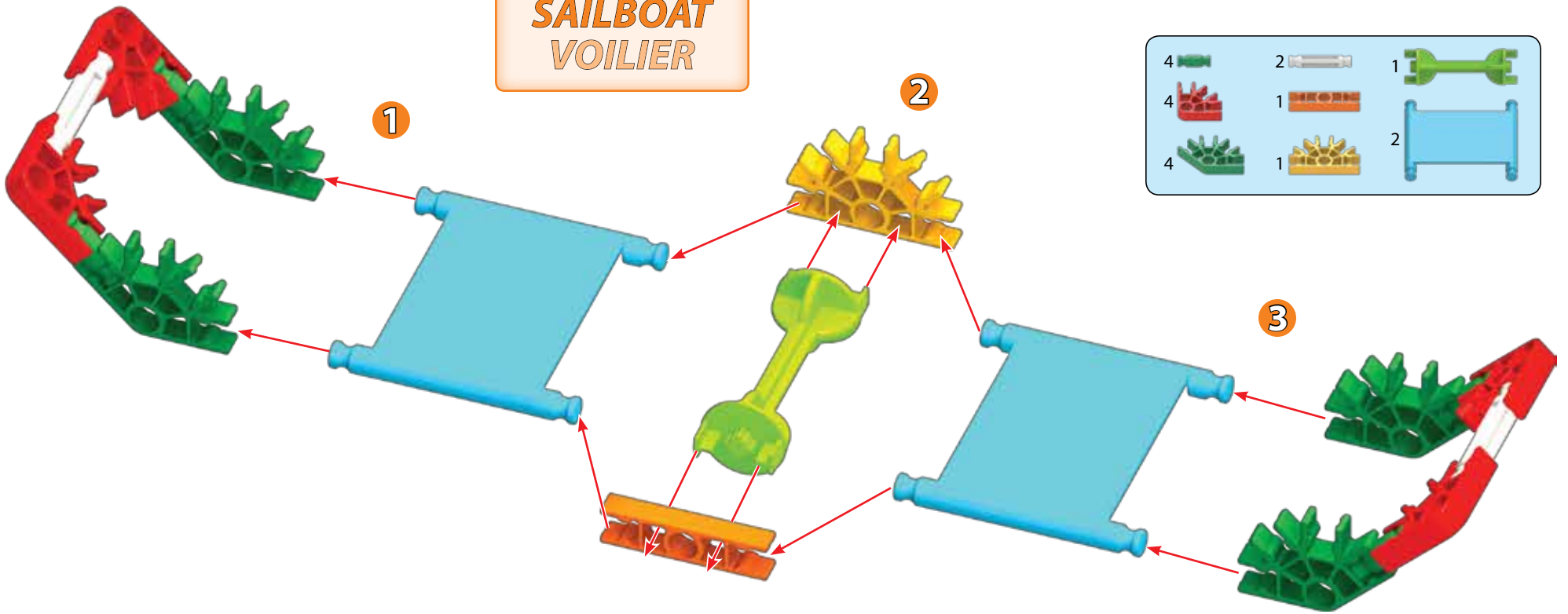

- | | | |
|---|---|---|
| 4 | 2 | 1 |
| 4 | 1 | 1 |
| 4 | 1 | 2 |

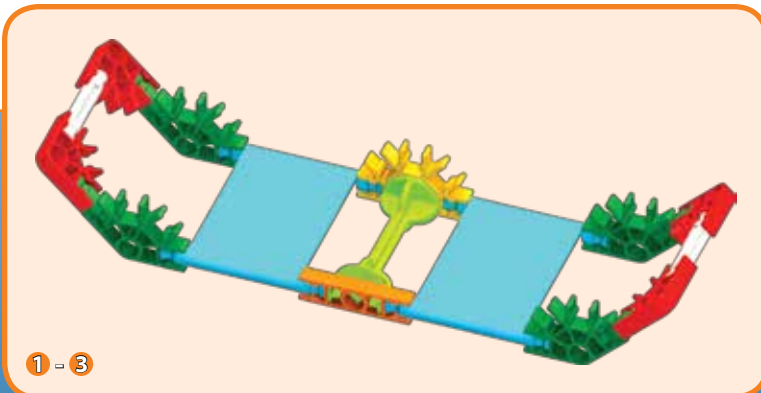

- | | | | |
|---|---|---|---|
| 1 | 1 | 1 | 2 |
| 1 | 2 | 1 | 1 |
| 1 | 2 | 1 | 1 |

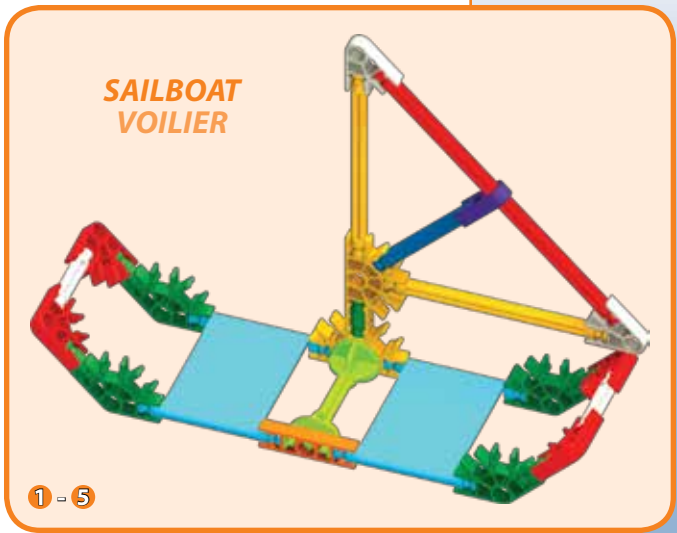
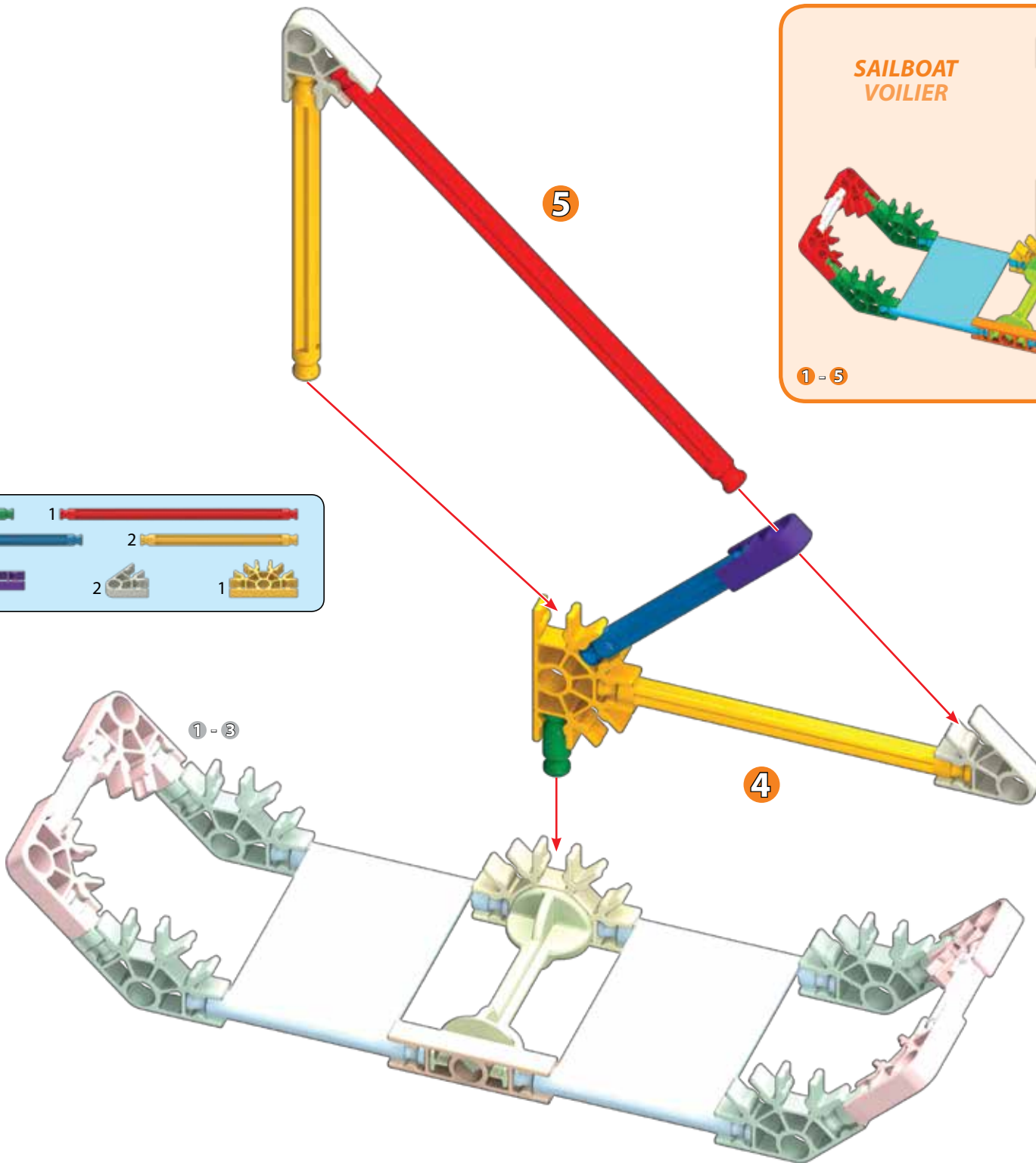

SCOOTER

3	2	1
2	1	
1	2	

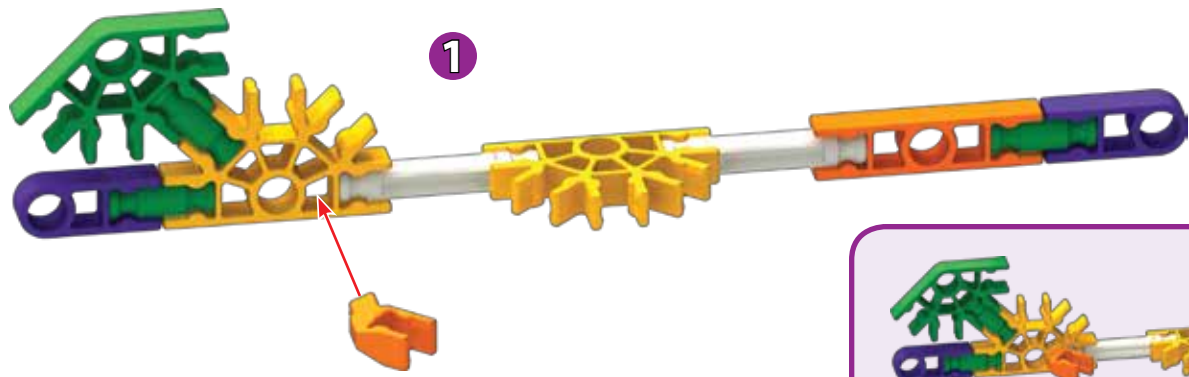

3	1
1	
2	1

2
1

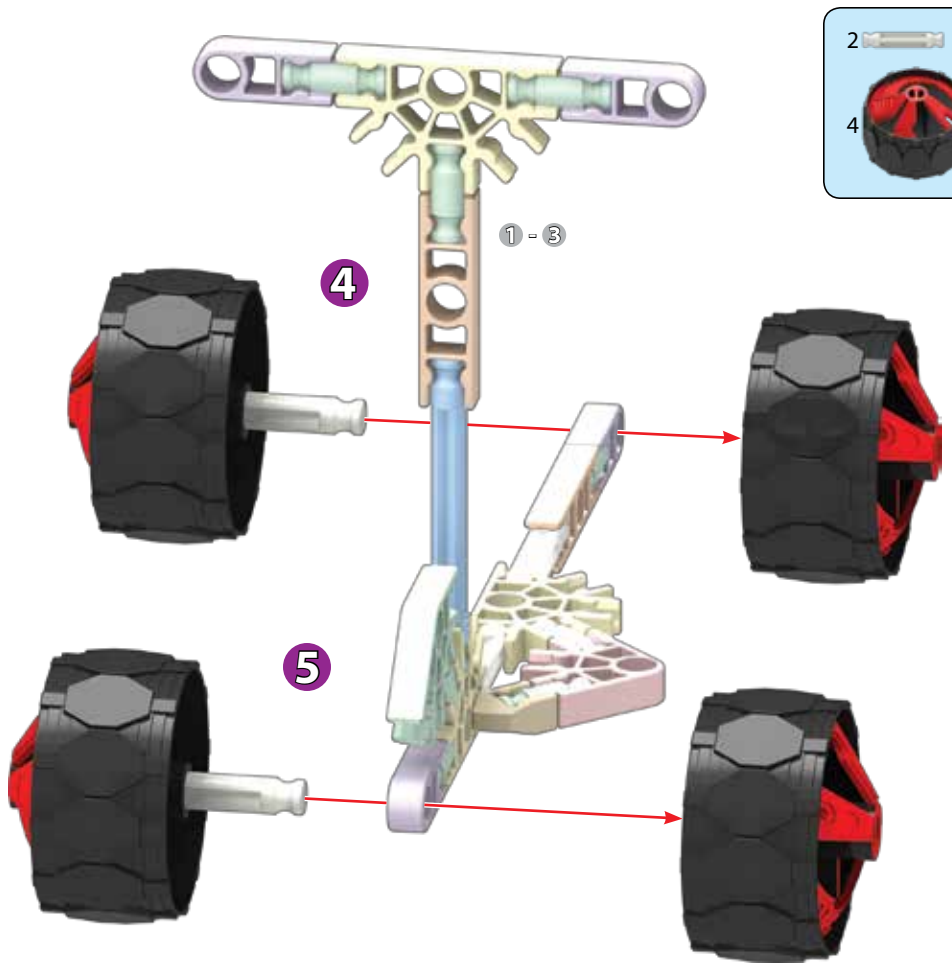

SKYSCRAPER GRATTE CIEL

1

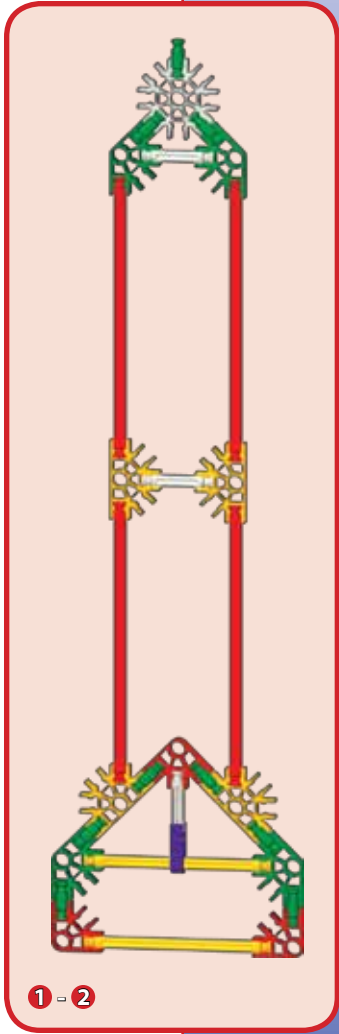
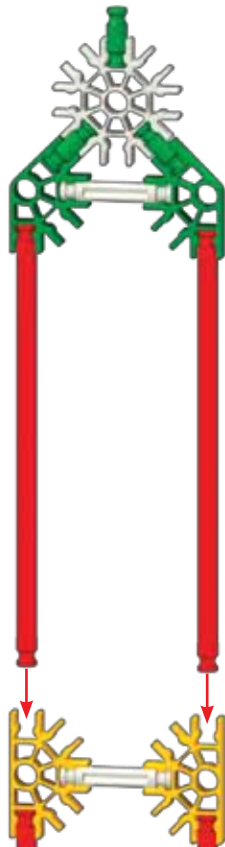
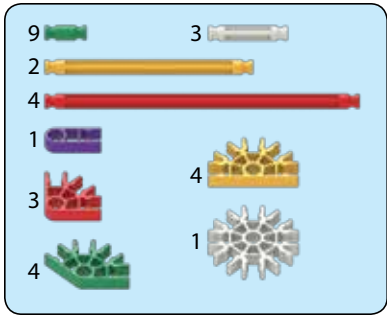

2

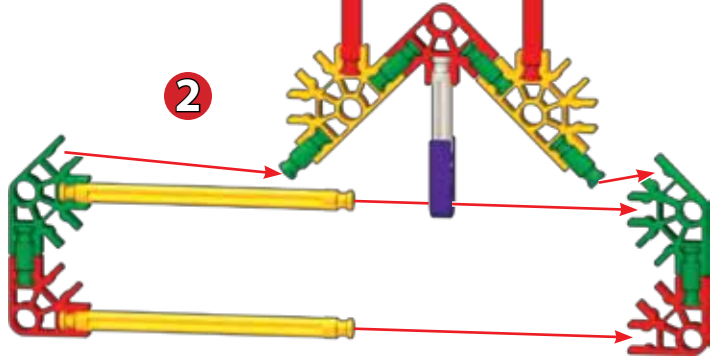

3

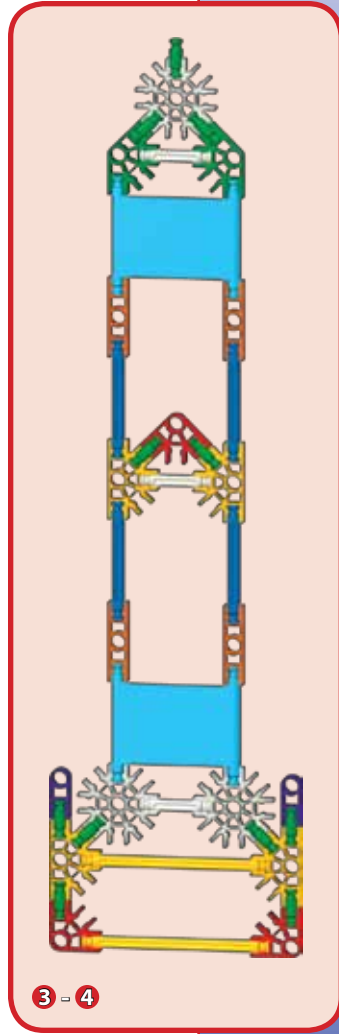
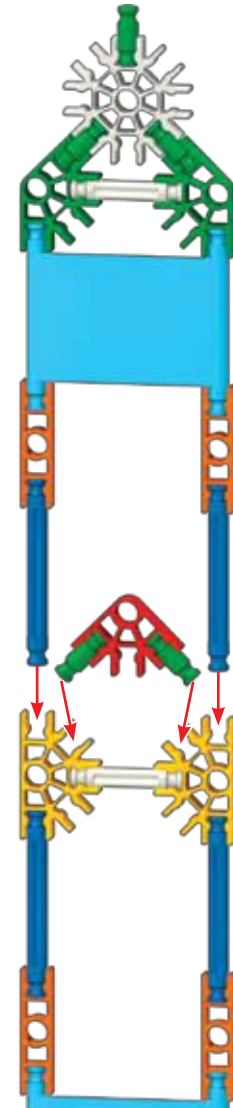
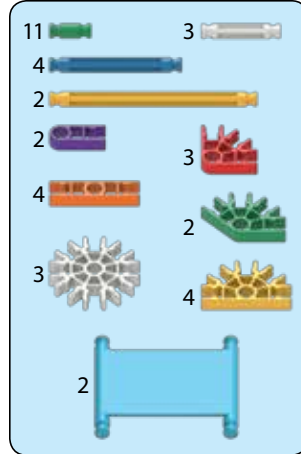

4

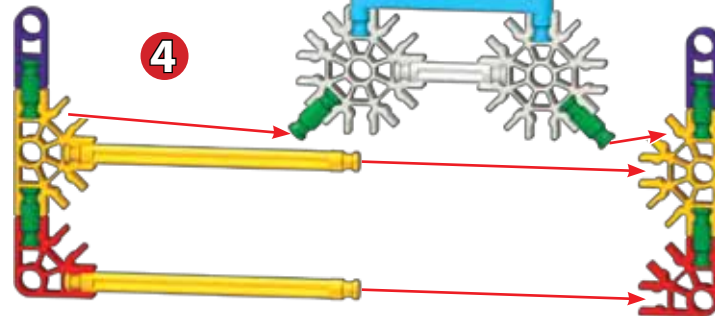

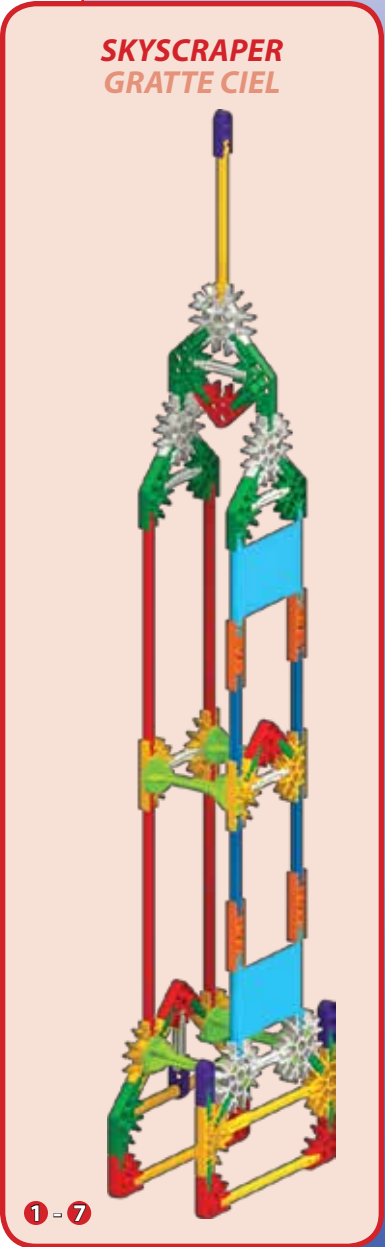
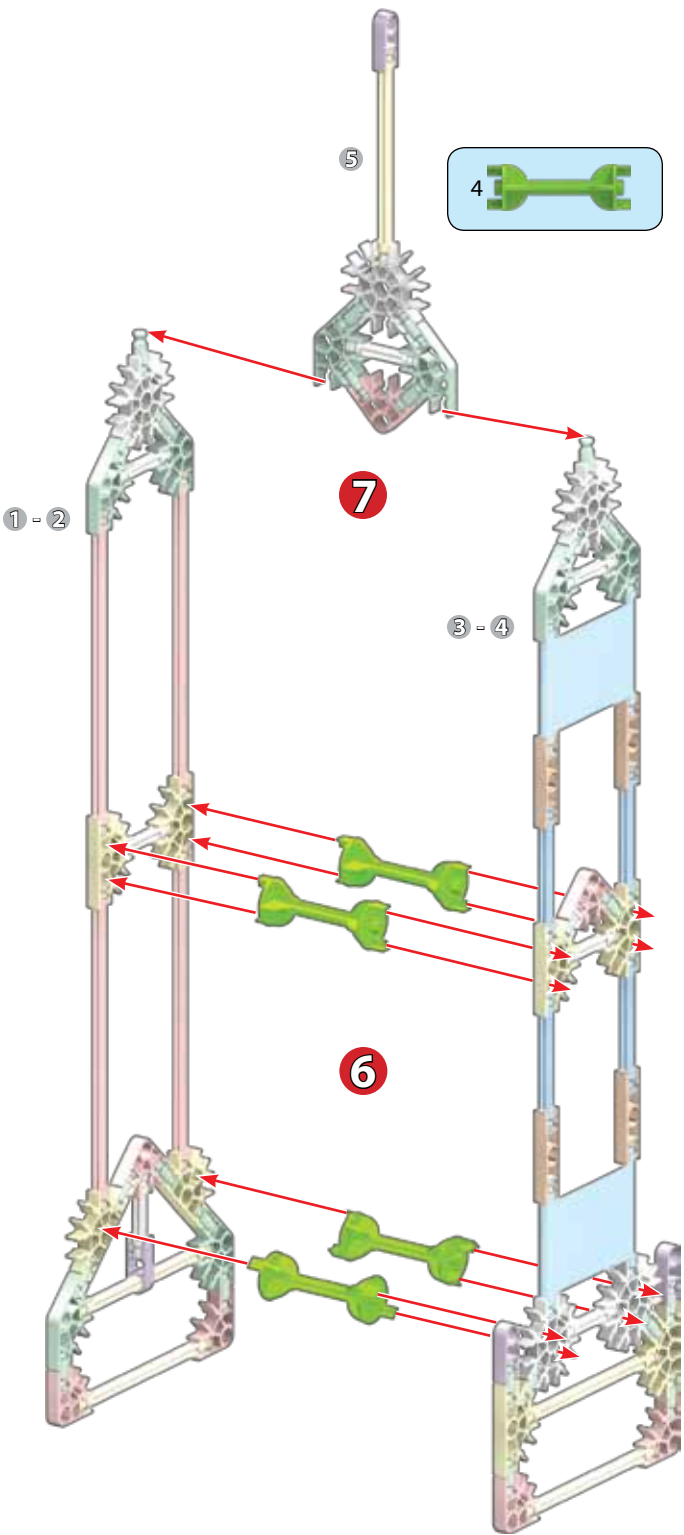
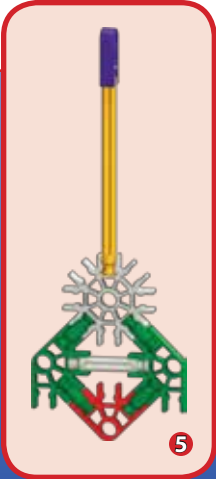
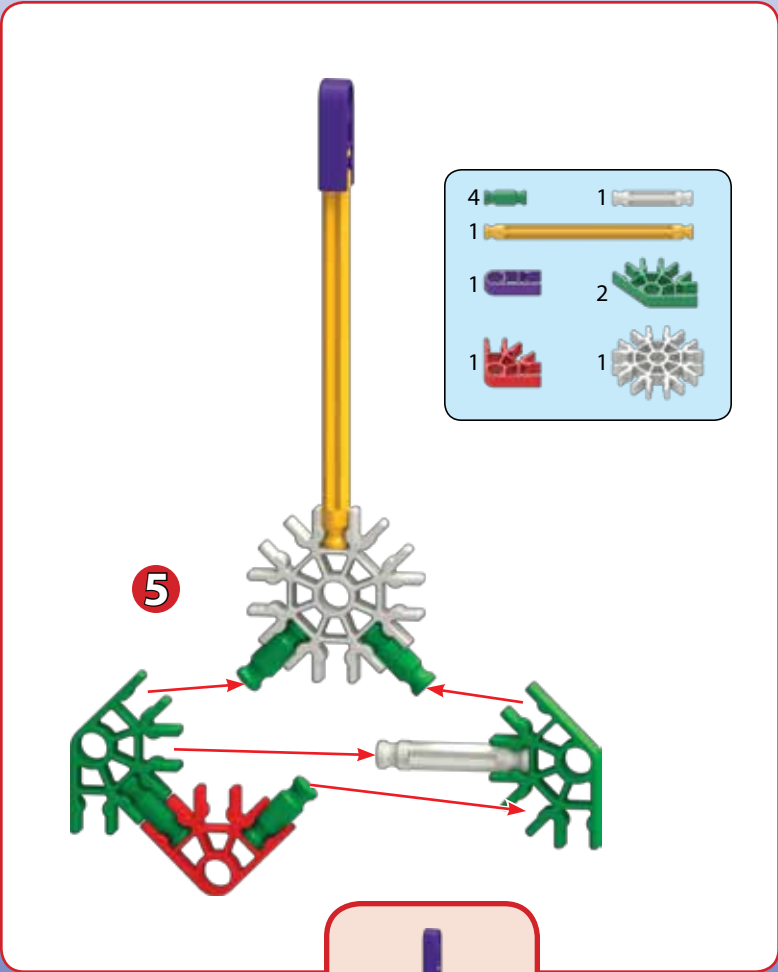

AIRPLANE AVION

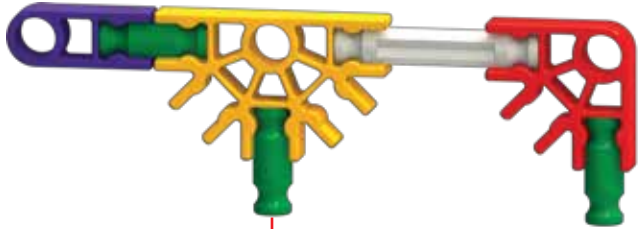

1

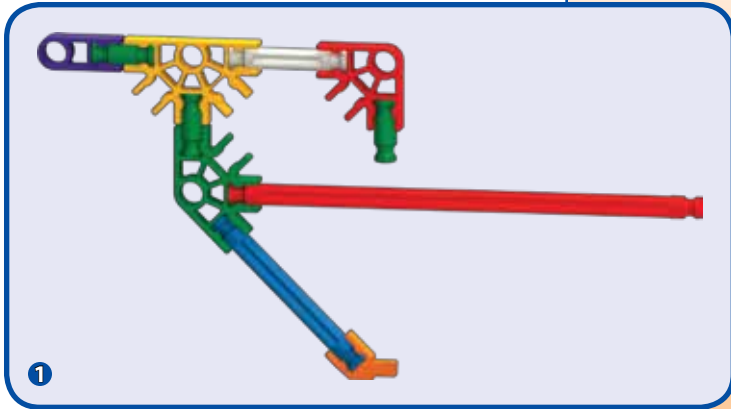
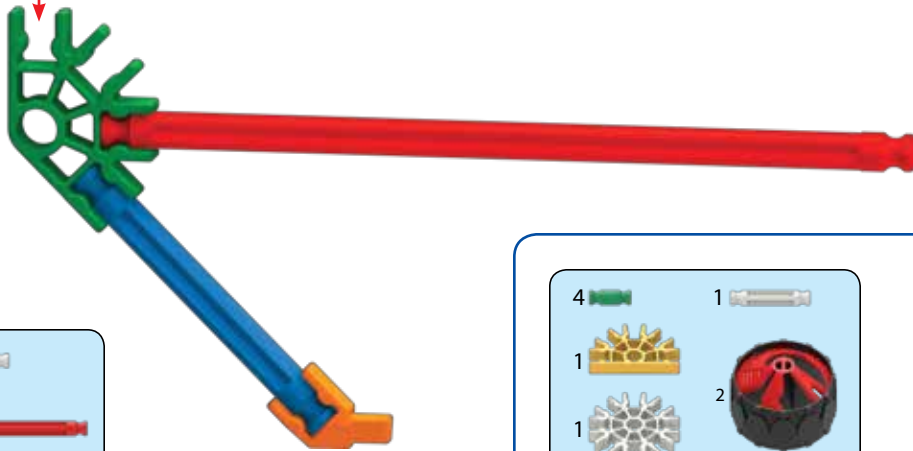

1

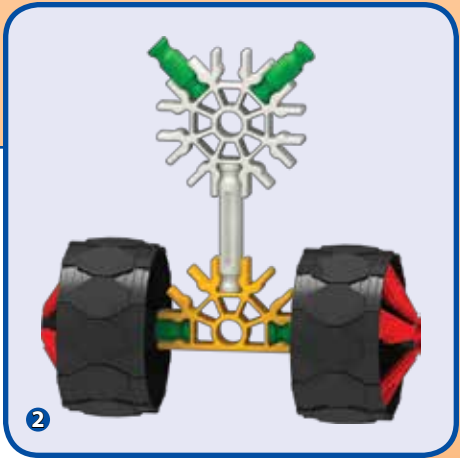
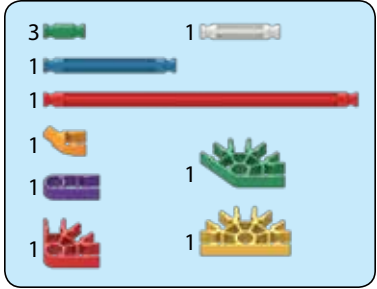

2

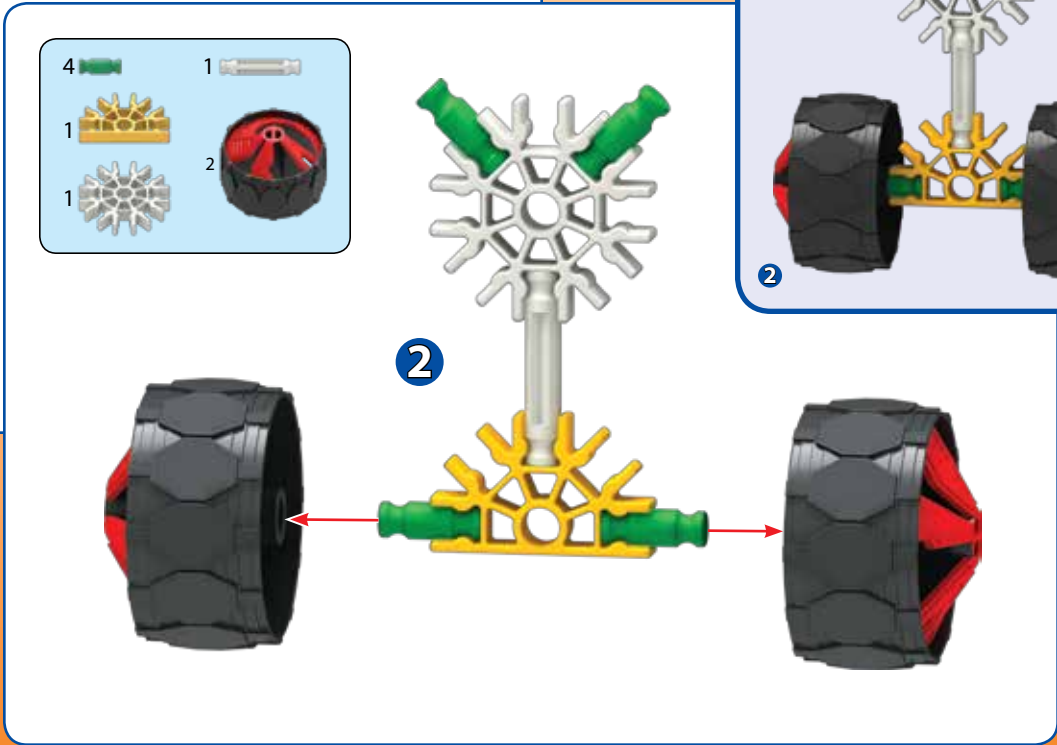

2

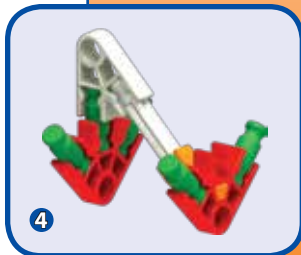
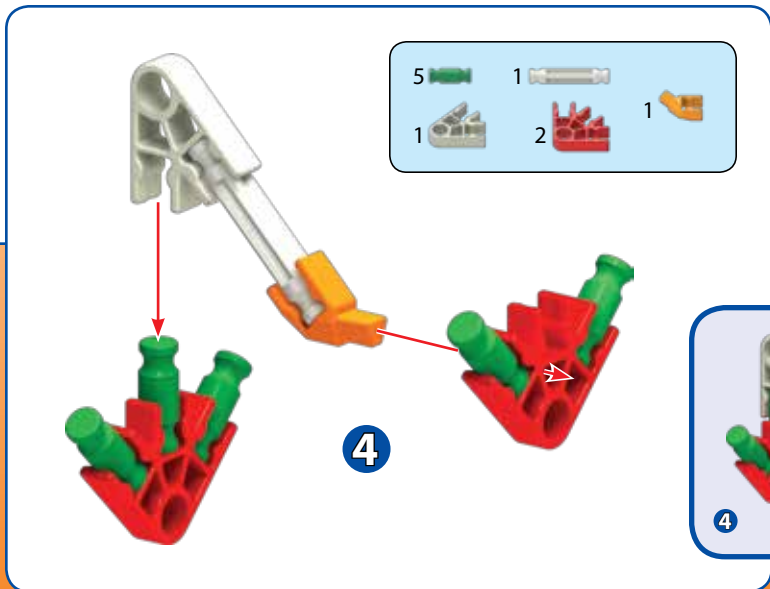
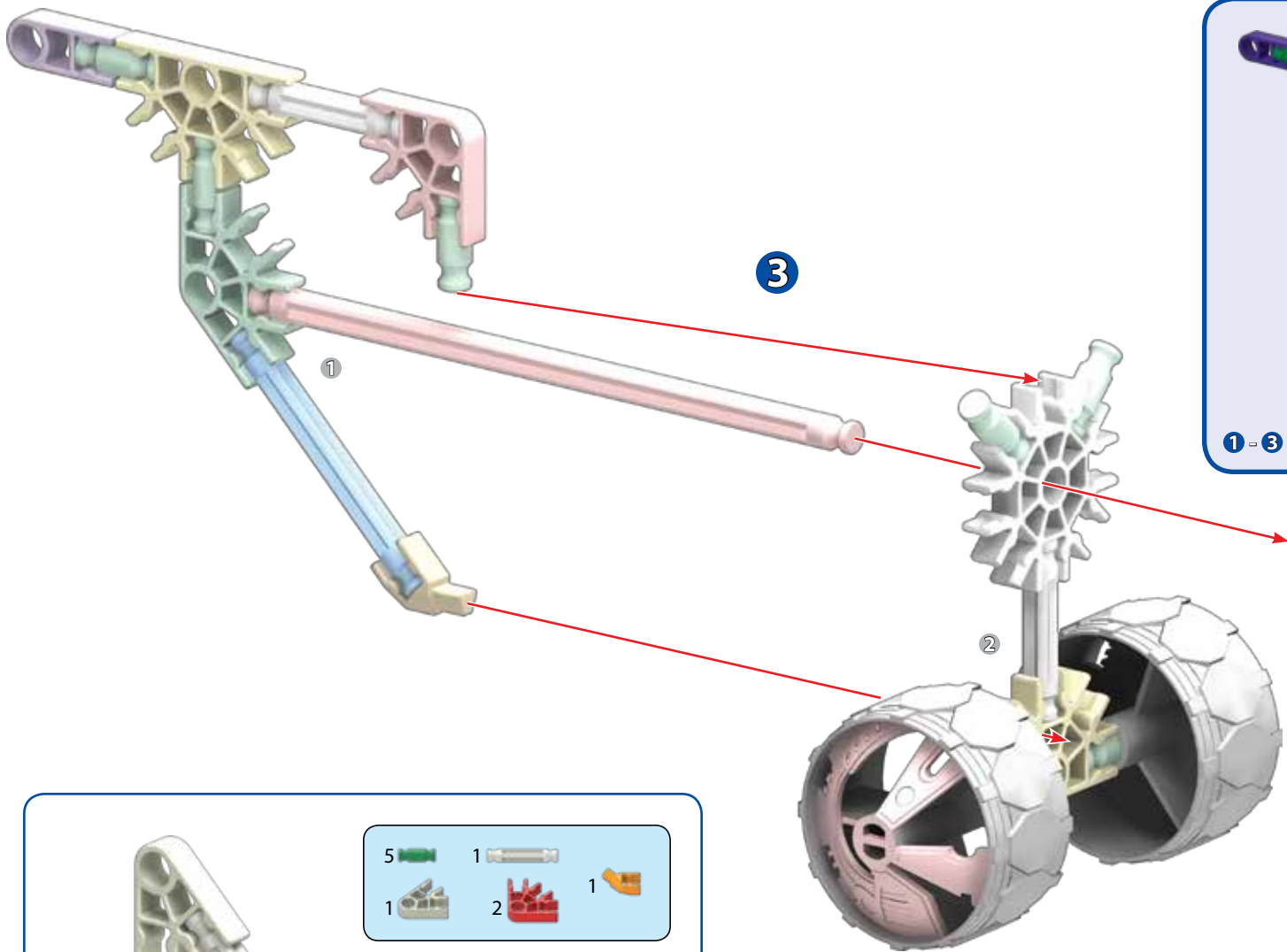

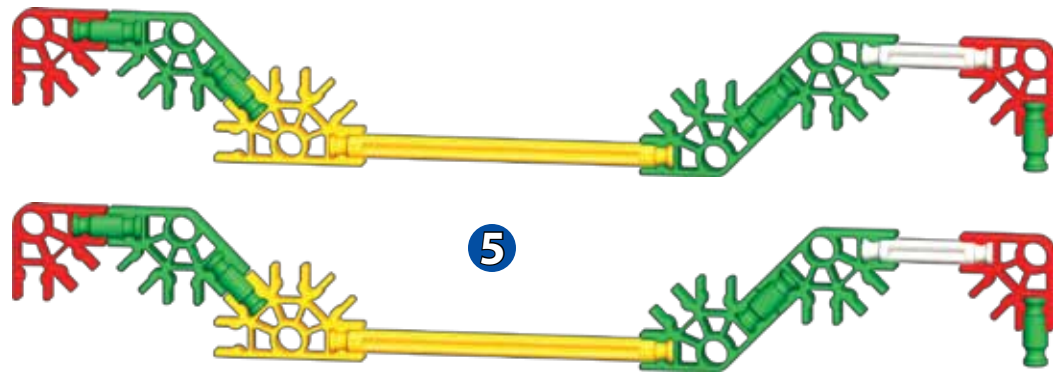

5

- | | |
|---|---|
| 8 | 2 |
| 2 | |
| 4 | |
| 2 | 6 |

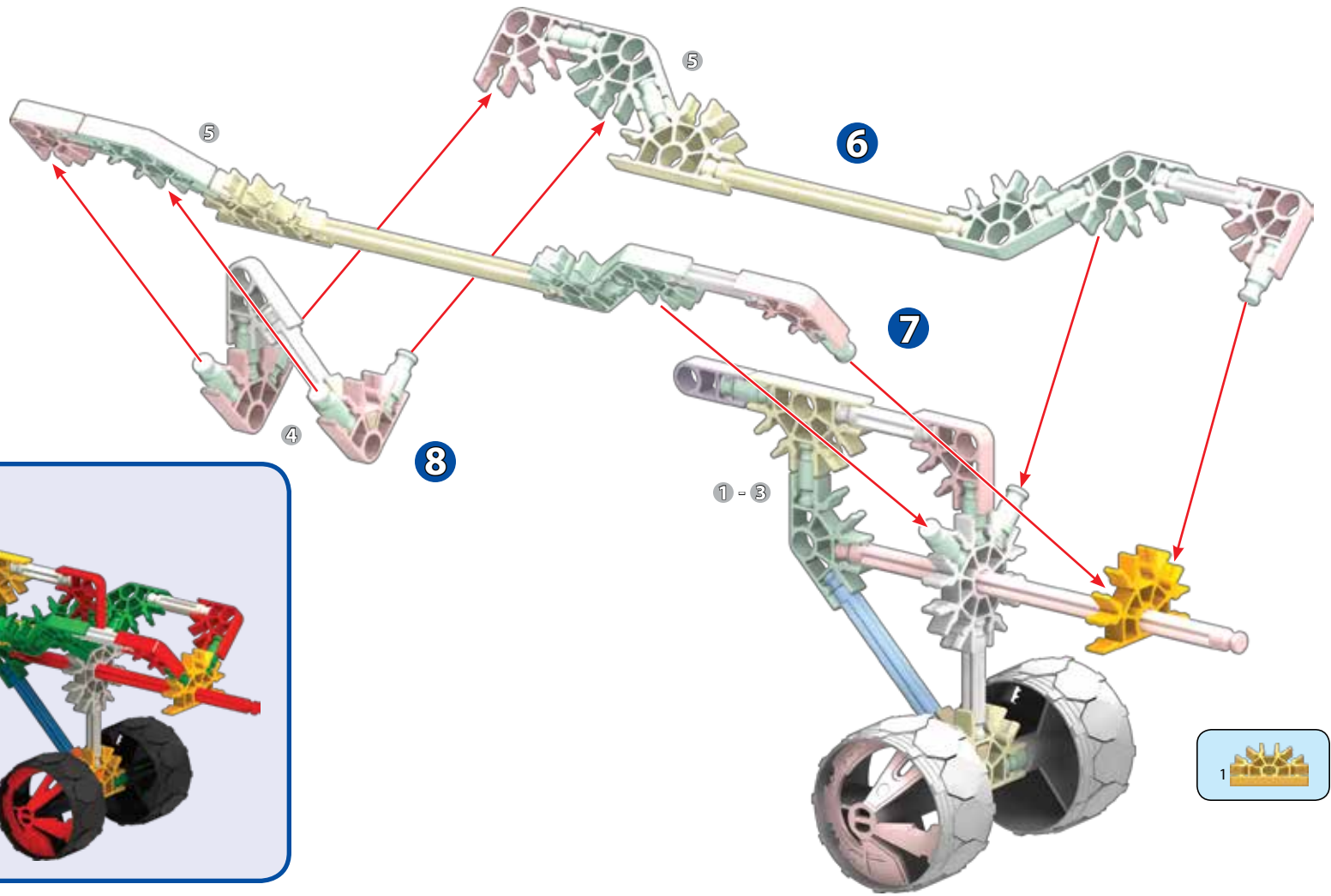

8

6

7

- | |
|---|
| 1 |
|---|



1 - 8

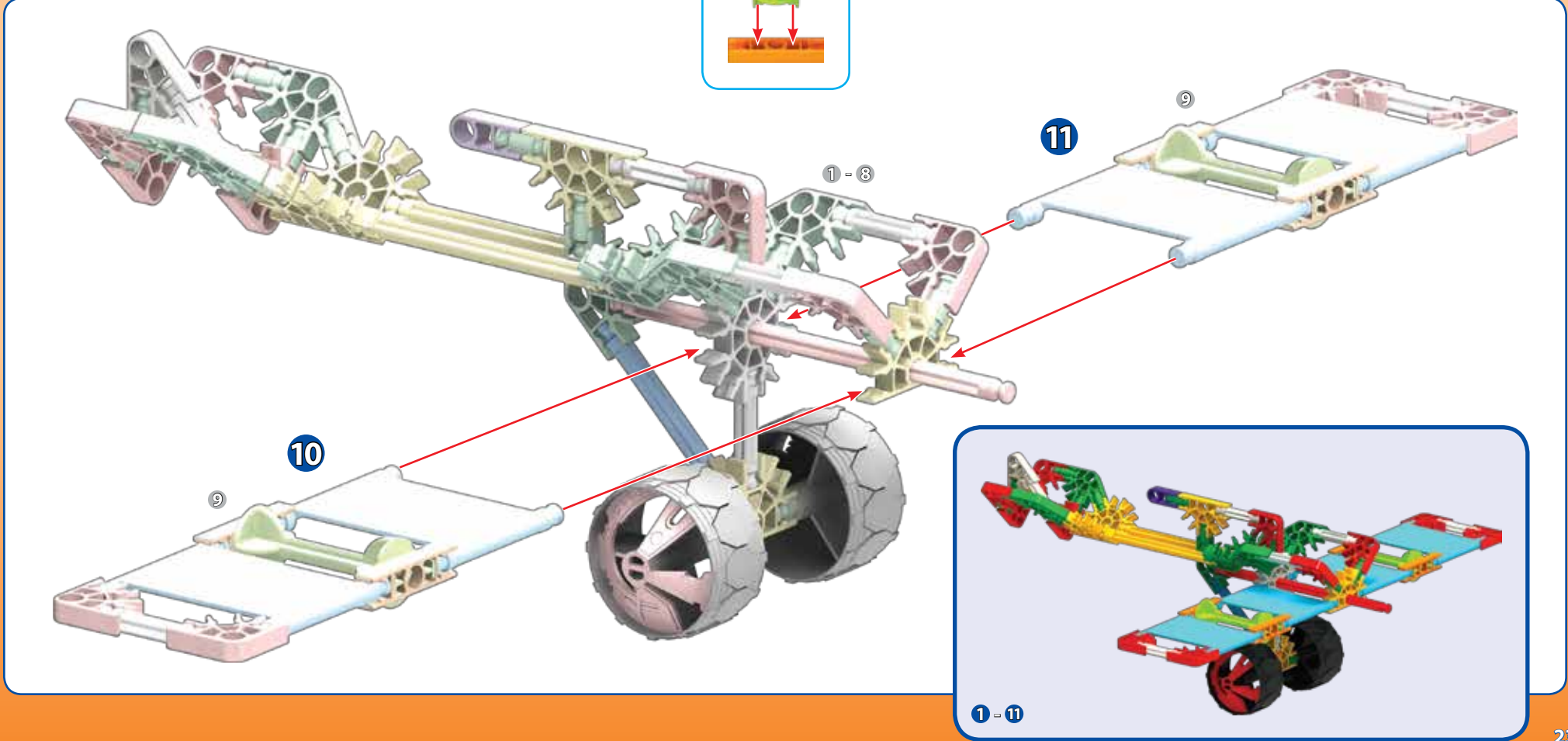
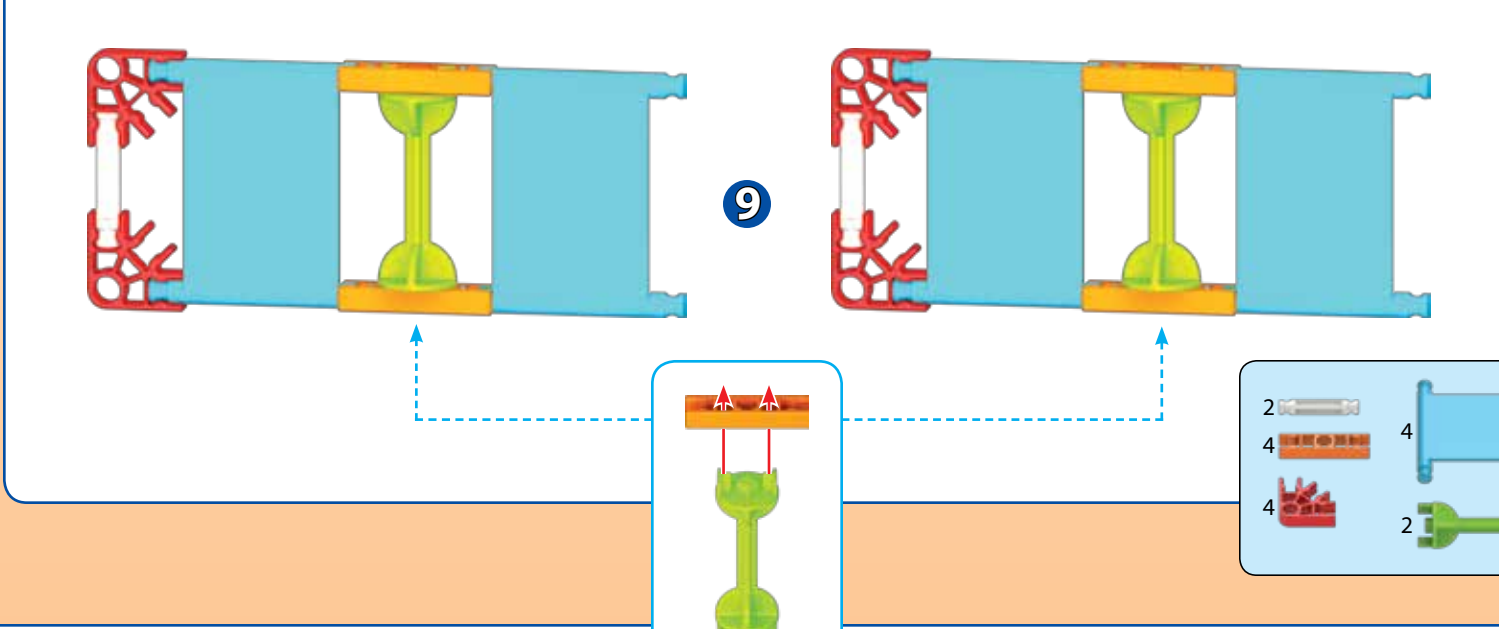

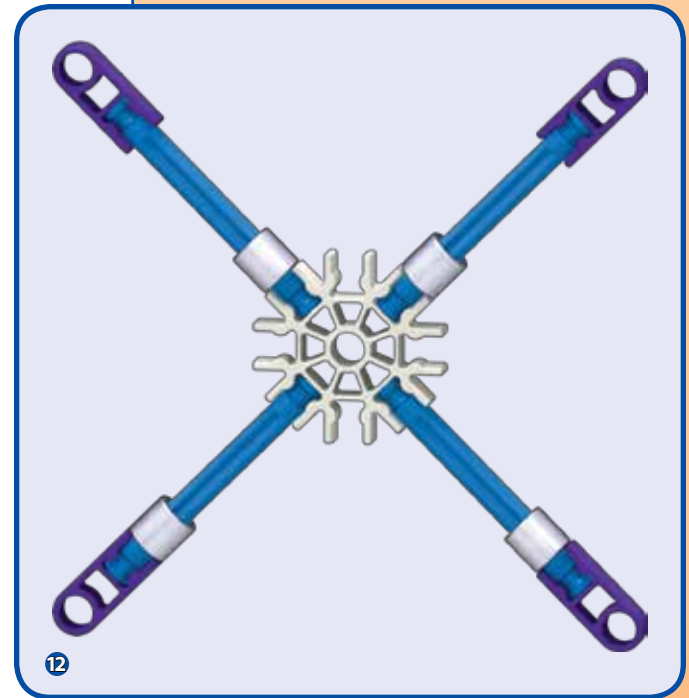
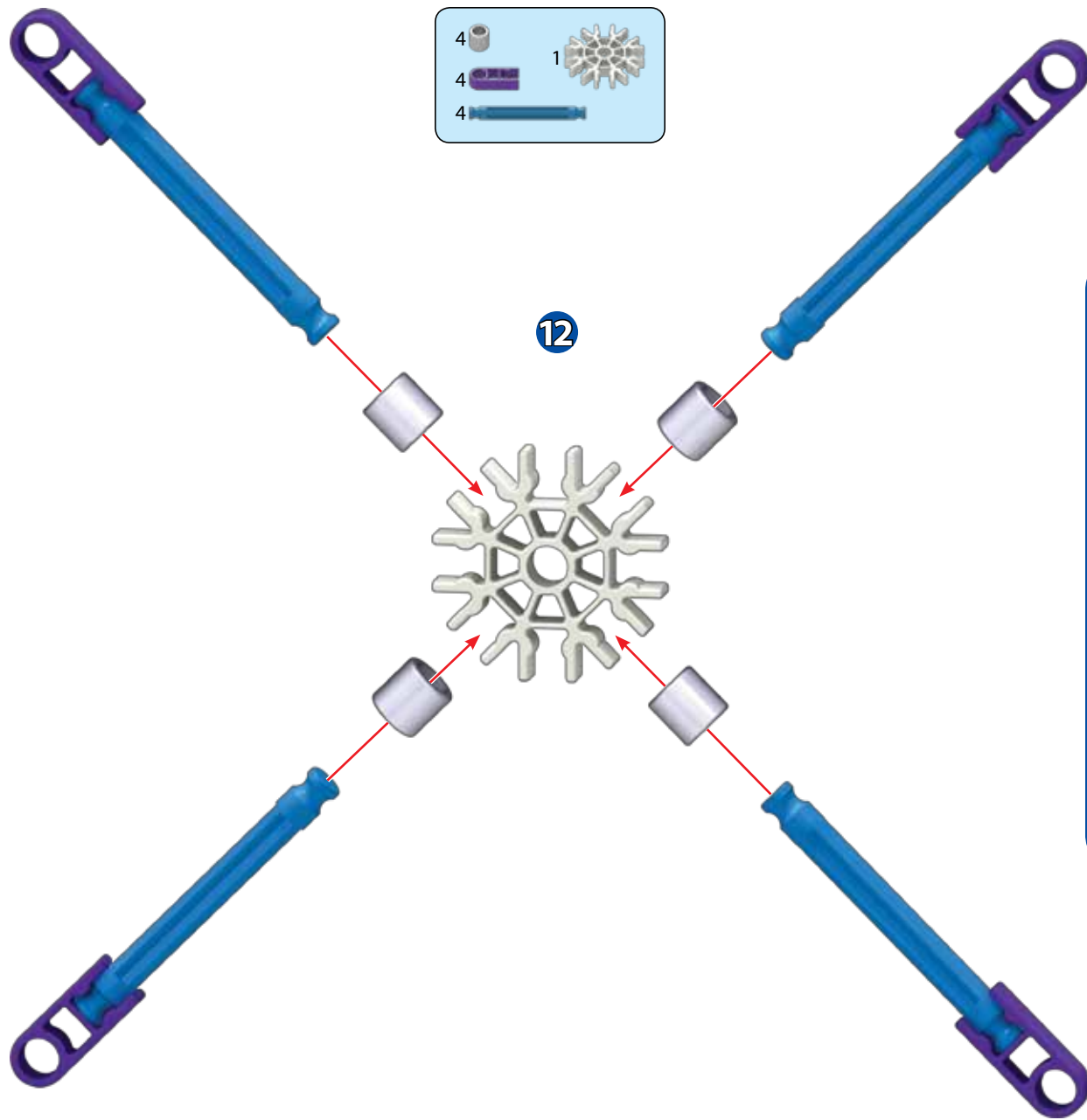

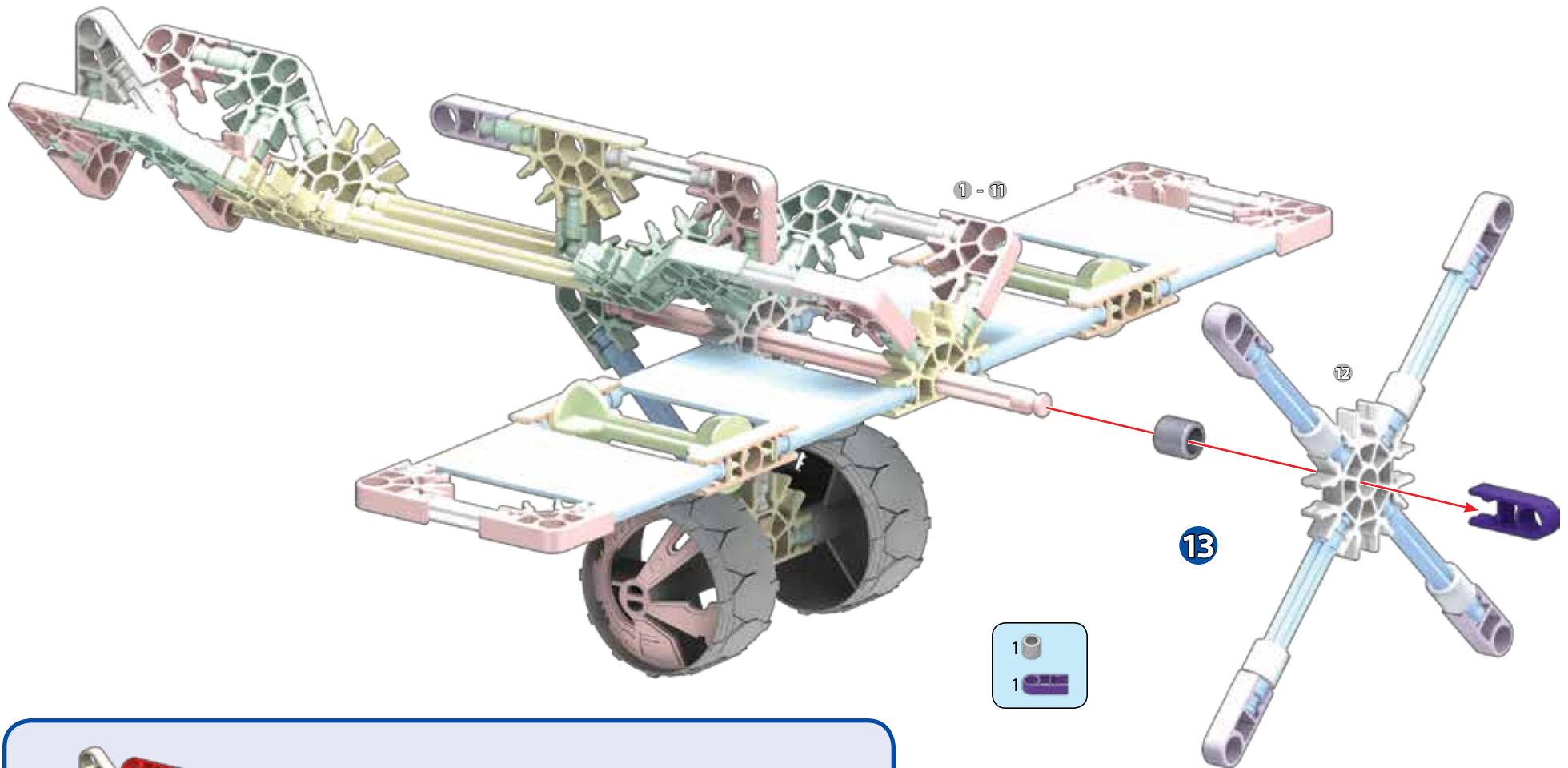

BUILDING IDEAS

For instructions of these models go to www.knex.com/instructions and enter code 15210.

IDÉES DE CONSTRUCTION

Pour les instructions de ces modèles vont à www.knex.com/instructions et entrez dans le code 15210.

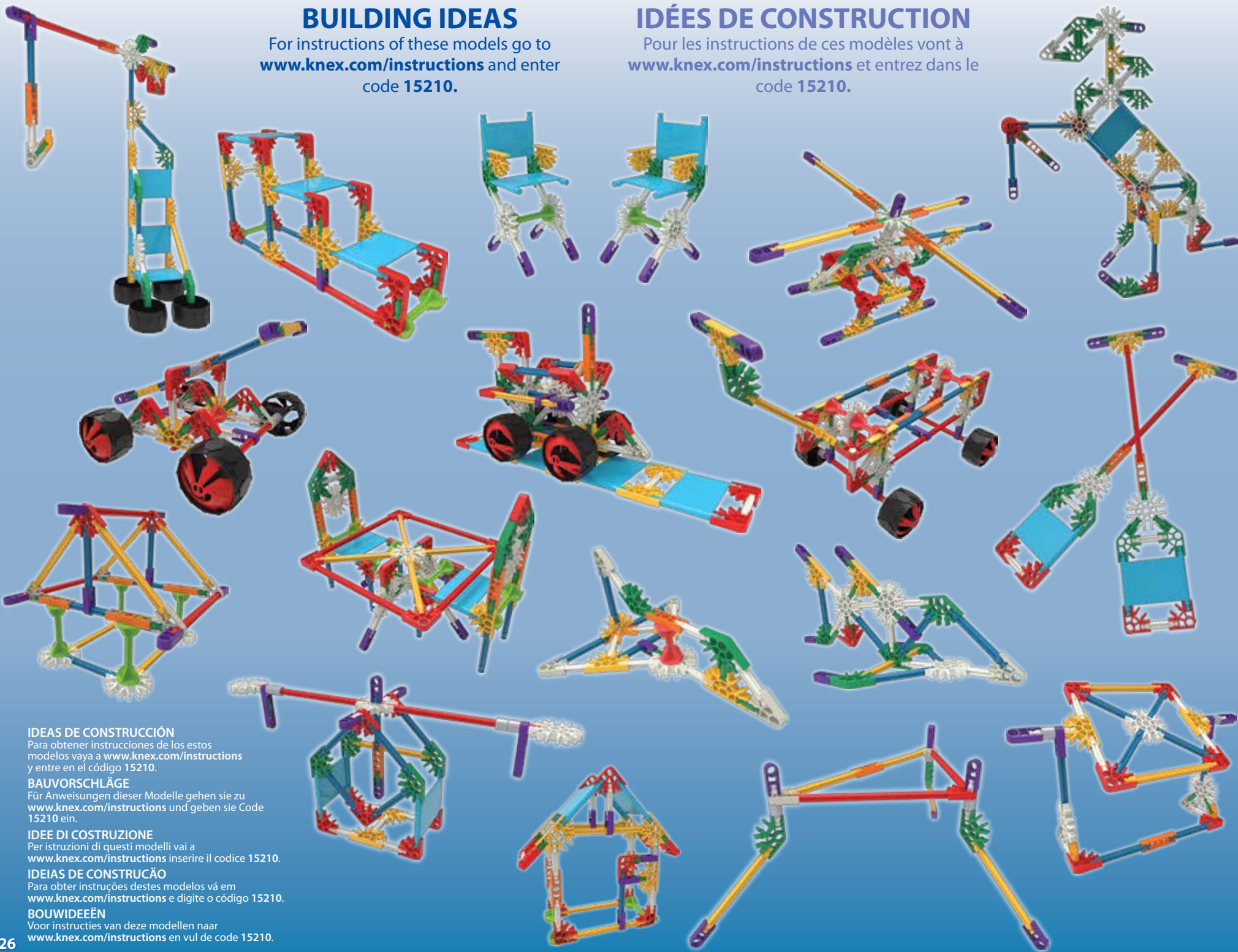

IDEAS DE CONSTRUCCIÓN

Para obtener instrucciones de los estos modelos vaya a www.knex.com/instructions y entre en el código 15210.

BAUVORSCHLÄGE

Für Anweisungen dieser Modelle gehen sie zu www.knex.com/instructions und geben sie Code 15210 ein.

IDEE DI COSTRUZIONE

Per istruzioni di questi modelli vai a www.knex.com/instructions inserire il codice 15210.

IDEIAS DE CONSTRUÇÃO

Para obter instruções destes modelos vá em www.knex.com/instructions e digite o código 15210.

BOUWIDEËN

Voor instructies van deze modellen naar www.knex.com/instructions en vul de code 15210.



(ES) Español

(Página 2)

Consejos de construcción

Explora conectando estas piezas K'NEX. Los puntos de conexión estarán en las aberturas internas del conector.

Siempre empuje la varilla K'NEX firmemente en el conjunto del neumático.

(Página 3)

Lista de Piezas

Si falta algo, visite www.Basicfun.com para contactarnos. ¡Estamos aquí para ayudarte!

La práctica hace la perfección

Intenta construir estas formas básicas con tus piezas K'NEX antes de comenzar a construir modelos.

(Página 4)

¿SABÍAS? Muchas piezas de K'NEX se pueden sustituir por otras piezas para hacer la misma forma de tamaño.

(Página 5)

CONSTRUYE 2

(Página 7)

Las nuevas piezas que agregues estarán en colores vivos.

(Página 9)

CONSEJOS: Mientras construyes, trata de colocar tu modelo en la misma dirección que se muestra en las instrucciones.

(DE) Deutsch

(Seite 2)

Tipps zum Bauen

Erkunden Sie die Verbindung dieser K'NEX-Teile. Die Anschlusspunkte befinden sich an den inneren Öffnungen des Steckverbinders.

Schieben Sie die K'NEX-Stange immer fest in die Reifenbaugruppe.

(Seite 3)

Teileliste

Wenn etwas fehlt, besuchen Sie bitte www.Basicfun.com, um uns zu kontaktieren. Wir sind hier, um dir zu helfen!

Übung macht den Meister

Erstellen Sie diese grundlegenden Formen mit Ihren K'NEX-Teilen, bevor Sie mit dem Erstellen von Modellen beginnen.

(Seite 4)

WUSSTEST DU? Viele K'NEX-Teile können durch andere Teile ersetzt werden, um dieselbe Größe zu erhalten.

(Seite 5)

BAUT 2

(Seite 7)

Blasse Farben weisen darauf hin, dass dieser Streckenabschnitt bereits zusammengebaut ist.

(Seite 9)

TIPP: Versuche, dein Modell beim Zusammenbauen so zu orientieren, dass es in die gleiche Richtung weist, wie es in den Anleitungen beschrieben und gezeigt wird.

(IT) Italiano

(Pagina 2)

Suggerimenti per la costruzione

Esplora la connessione di questi pezzi K'NEX. I punti di connessione saranno sulle aperture interne del connettore.

Spingere sempre saldamente l'asta K'NEX nel gruppo del pneumatico.

(Pagina 3)

Elenco delle parti

Se manca qualcosa, visitare www.Basicfun.com per contattarci. Siamo qui per aiutarvi!

La pratica rende perfetti

Prova a costruire queste forme di base con i tuoi pezzi K'NEX prima di iniziare a costruire modelli.

(Pagina 4)

LO SAPEVATE? Molti pezzi K'NEX possono essere sostituiti con altri pezzi per ottenere la stessa forma.

(Pagina 5)

CONSTRUISCE 2

(Pagina 7)

Dovrai collegare la nuova sezione al punto indicato dalla punta della freccia.

(Pagina 9)

SUGGERIMENTI: Orienta il tuo modello nella stessa direzione indicata nelle istruzioni.

(PT) Português

(Página 2)

Dicas de construção

Explore a conexão dessas peças do K'NEX. Os pontos de conexão estarão nas aberturas internas do conector.

Sempre empurre a haste K'NEX firmemente no conjunto do pneu.

(Página 3)

Lista de peças

Se alguma coisa estiver faltando, por favor visite www.Basicfun.com para nos contatar. Estamos aqui para ajudá-lo!

A prática leva à perfeição

Tente criar essas formas básicas com suas peças K'NEX antes de começar a criar modelos.

(Página 4)

VOCÊ SABIA? Muitas peças K'NEX podem ser substituídas por outras peças para obter a mesma forma de tamanho.

(Página 5)

CONSTRÓI 2

(Página 7)

Passarás então a fazer a conexão da nova seção no local indicado pelas setas.

(Página 9)

SUGESTÕES: Tenta fazer com que o teu modelo esteja virado exactamente na mesma direcção indicada nas instruções.)

(NL) Nederlands

(Bladzijde 2)

Bouw tips

Ontdek hoe je deze K'NEX-stukken verbindt. De verbindingpunten bevinden zich aan de binnenzijde van de openingen van de connector.

Duw de K'NEX-stang altijd stevig in de bandmontage.

(Bladzijde 3)

Lijst met onderdelen

Als er iets ontbreekt, bezoek dan www.Basicfun.com om contact met ons op te nemen. We zijn er om u te helpen!

Oefening baart kunst

Probeer deze basisvormen te bouwen met uw K'NEX-onderdelen voordat u modellen gaat bouwen.

(Bladzijde 4)

VOCÊ SABIA? Muitas peças K'NEX podem ser substituídas por outras peças para obter a mesma forma de tamanho.

(Bladzijde 5)

BOUWT 2

(Bladzijde 7)

Gelieve het nieuwe deel vast te koppelen op de plaats aangeduid door de pijlen.

(Bladzijde 9)

TIP: Tracht je model in dezelfde richting te plaatsen als de aanwijzingen terwijl je bouwt en monteert.



Beginner 40 Model Building Set
Modèle Débutant 40
Jeu de construction

knex.com

facebook.com/knex

@knex

BUILDER BASICS™
 Building Set

ÉLÉMENTS ESSENTIELS DE CONSTRUCTION
 Jeu de construction



FPO

STEALTH PLANE™
 Building Set
AVION FURTIF
 Jeu de construction



FPO

MOTORCYCLE™
 Building Set
MOTO
 Jeu de construction



FPO

ROCKET CAR™
 Building Set
VOLANTIN
 Jeu de construction



****Sold separately**
 Vendus séparément
 Se venden por separado
 Separat erhältlich
 Venduti separatamente
 Vendidos separadamente
 Afzonderlijk verkrijgbaar

©2019 K'NEX, a Division of Basic Fun Inc., P.O. Box 700, Hatfield, PA 19440-0700; 1-800-KID-KNEX (USA/Canada/États-Unis); email@knex.com; knex.com. K'NEX UK Ltd., 200 Brook Drive, Green Park, Reading, RG6 2UB England; K'NEX France, 24 rue du Quatre Septembre, 75002 Paris, France.

(EN) K'NEX is a registered trademark of Basic Fun, Inc. For customers outside the USA/Canada please contact your local distributor at www.knex.com/distributors

(FR) K'NEX est une marque déposée de Basic Fun, Inc. Pour les clients en dehors du Canada et des États-Unis, veuillez contacter votre distributeur local que vous pouvez trouver sur www.knex.com/distributors

(EN) K'NEX es una marca registrada de Basic Fun, Inc. Para clientes fuera de los EE.UU. y Canadá, por favor póngase en contacto con su distribuidor local en www.knex.com/distributors

- (EN) Product & colors may vary. Most models can be built one at a time.
- (FR) Le produit et ses couleurs peuvent varier. Les différents modèles ne peuvent être construits qu'un par un.
- (ES) El producto y los colores pueden variar. La mayoría de los modelos se pueden construir uno a la vez.
- (DE) Produkte und Farben können abweichen. Die meisten Modelle können immer nur einzeln gebaut werden.
- (IT) Prodotti e colori possono differire. La maggior parte dei modelli si può costruire autonomamente. Istruzioni accluse.
- (PT) O produto e as cores podem variar. A maioria dos modelos pode ser montado um de cada vez.
- (NL) Product en kleuren kunnen variëren. De meeste modellen kunnen uitsluitend een voor een worden gebouwd.

