

K'NEX®

Building Worlds Kids Love®

40 MODEL
BUILDING SET
40 MODÈLE
JEU DE
CONSTRUCTION

40

*Building Ideas!
Idées de
Construction !**

7+

13687



AMERICA'S
BUILDING TOY™
JOUET DE CONSTRUCTION
d'AMÉRIQUE™

(EN)

Content

Clock Tower	4
Milk Shake	4
Rocket	4
Wheelchair	5
Buggy	6
Race Car	7
Boat Ride	9
Crane	12
Helicopter	15
Big Box Truck	18
Model Ideas	22

⚠ WARNING: CHOKING HAZARD - SMALL PARTS. Not for children under 3 years.

CAUTION: Rubber Bands can cause injury from snap-back, breaking, or loss of control. While assembling models shown in instructions, hold rubber band tightly, and do not overstretch. Use Rubber Bands only as shown in these instructions. **DO NOT USE FRAYED OR TORN RUBBER BANDS.**

CAUTION: Keep Rubber Bands away from face and eyes.

K'NEX Building Basics

Start Building

To begin your model, find step number 1 and follow the numbers. Each piece has its own shape and color. Look at the pictures, find the pieces that match what you see, and connect them together. It helps to face your model in the same direction as the instructions while you build. The arrows show you where the parts connect, but not all connection points have arrows. The faded color parts are the ones you have already put together.

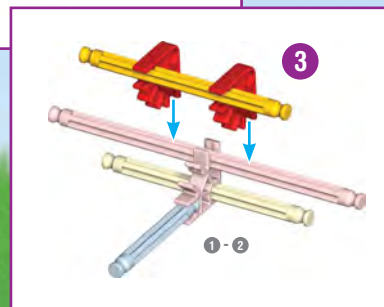
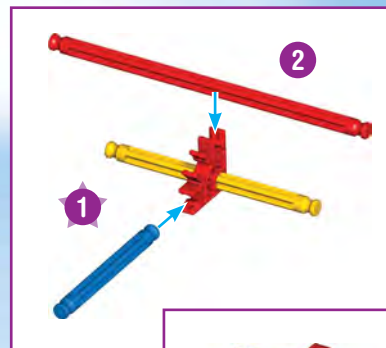

Spacers

There are places in your model where you need to use spacers. Be sure to use the correct number of spacers shown in the instructions.

Connectors

You can slide these special connectors together. Push tightly until you hear a "click". Pay close attention to the instructions and position them horizontally or vertically exactly as they are shown.

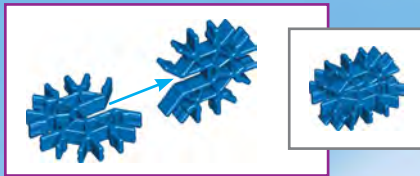
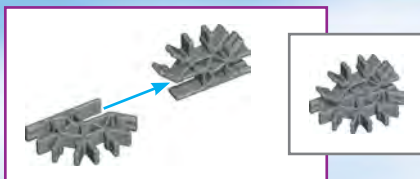
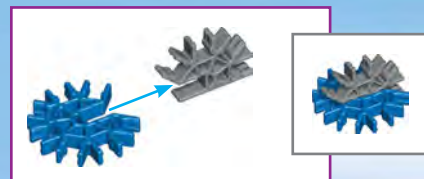

Parts List

Before you start building, be sure to compare the parts in your set with the parts listed here. If anything is missing, call or write to us using the information on the back cover. We're here to help!



(FR)

Contenus

Tour de l'Horloge	4
Lait Secousse	4
Fusée	4
Fauteuil Roulant	5
Voiture	6
Racer	7
Tour de Bateau	9
Grue	12
Hélicoptère	15
Grand Camion de Boîte	18
Idées Modèles	22

⚠ ATTENTION ! RISQUE D'ÉTOUFFEMENT – Pièces de petite taille. Ne convient pas aux enfants de moins de 3 ans.

ATTENTION : Les élastiques peuvent causer des blessures en claquant, en se cassant ou quand on les manipule imprudemment. Tenez fermement l'élastique lors de l'assemblage du modèle en veillant à ne pas trop le tendre. N'utilisez les élastiques que selon les instructions. **N'UTILISEZ PAS D'ÉLASTIQUES ÉRAILLÉS OU DÉCHIRÉS.**

ATTENTION : Tenez les élastiques en caoutchouc à l'écart du visage et des yeux.

Notions de Base K'NEX Pour Le Montage

Commence La Construction

Pour commencer ton modèle, trouve l'étape numéro 1 et suis les numéros. Chaque pièce a sa propre forme et sa propre couleur. Regarde les illustrations, trouve les pièces qui correspondent à ce que tu vois et assemble-les. Pour t'aider pendant que tu construis, oriente ton modèle dans le même sens que les instructions. Les flèches t'indiquent où les pièces s'assemblent, mais les points de raccordement n'ont pas tous des flèches. Les pièces de couleur délavée sont celles que tu as déjà assemblées.

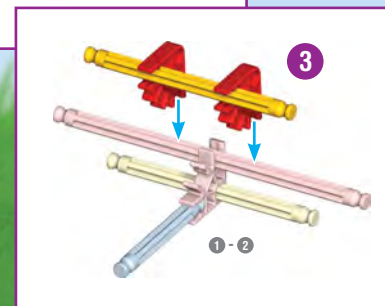

Espaceurs

Il y a des endroits sur ton modèle ou tu auras besoin de te servir d'espaceurs. Assure-toi d'utiliser la bonne couleur et le nombre d'espaceurs indiqué sur les instructions.

Connecteurs

Tu peux assembler ces connecteurs tout à fait uniques en les faisant glisser l'un avec l'autre. Pousse fort jusqu'à ce que tu entendes un « clic ». Lis les instructions attentivement et positionne-les horizontalement ou verticalement, en suivant exactement les illustrations.

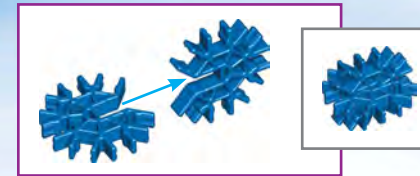
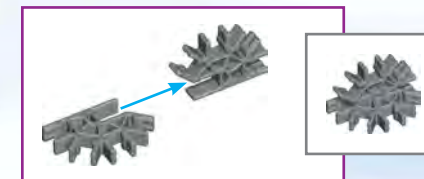
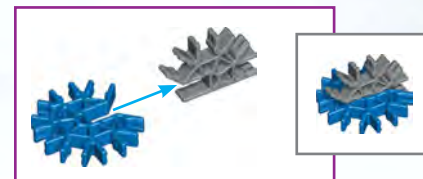

Liste des Pièces

Avant de commencer à construire, assure-toi de comparer les pièces dans ta boîte à la liste de pièces fournie ici. S'il manque quelque chose, téléphone-nous ou écris-nous en te servant des informations figurant au verso de la notice. Nous sommes là pour t'aider !

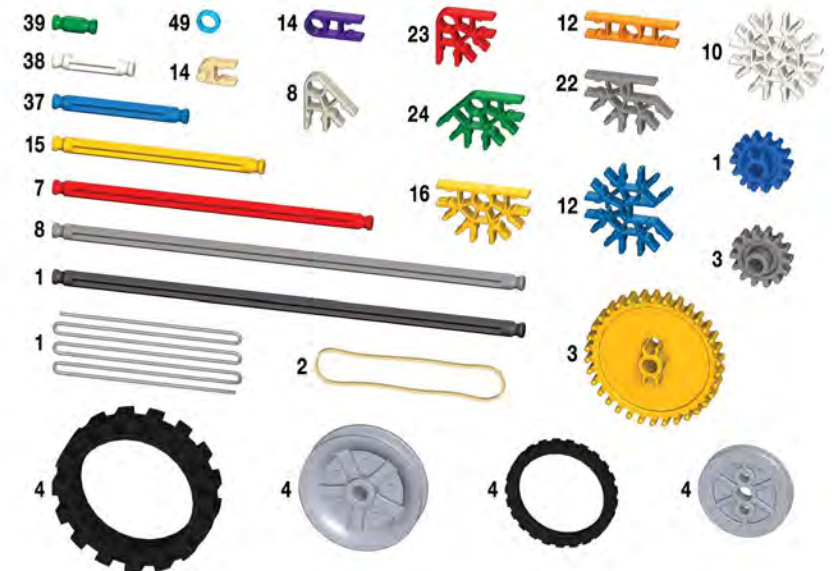

Clock Tower

Tour de l'Horloge



Milk Shake
Lait Secousse

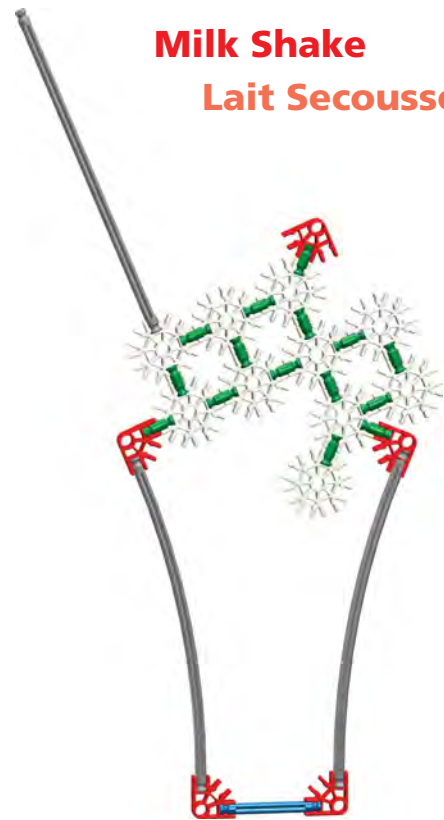

Rocket

Fusée



Wheelchair

Fauteuil Roulant

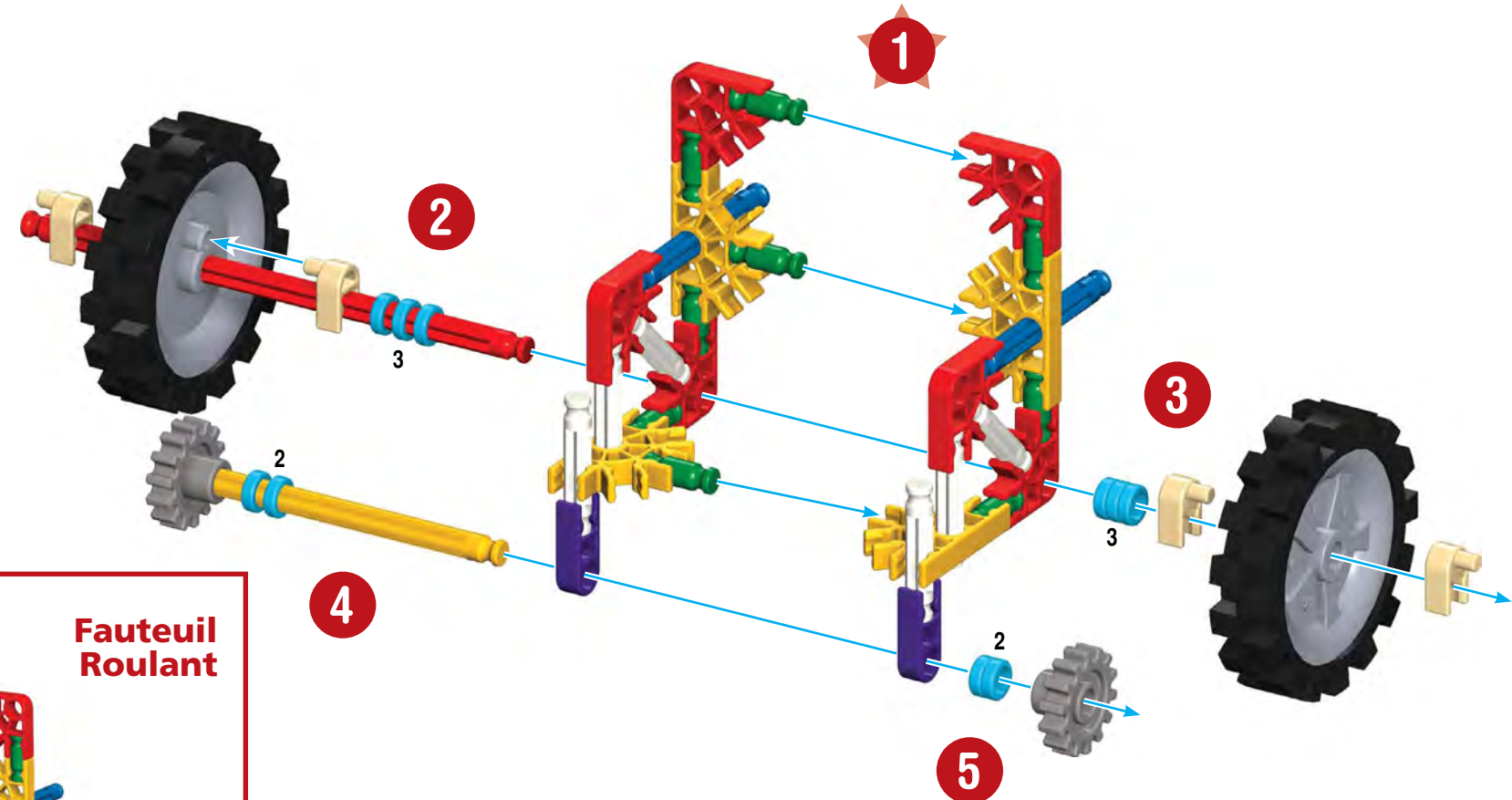

**Buggy
Voiture**

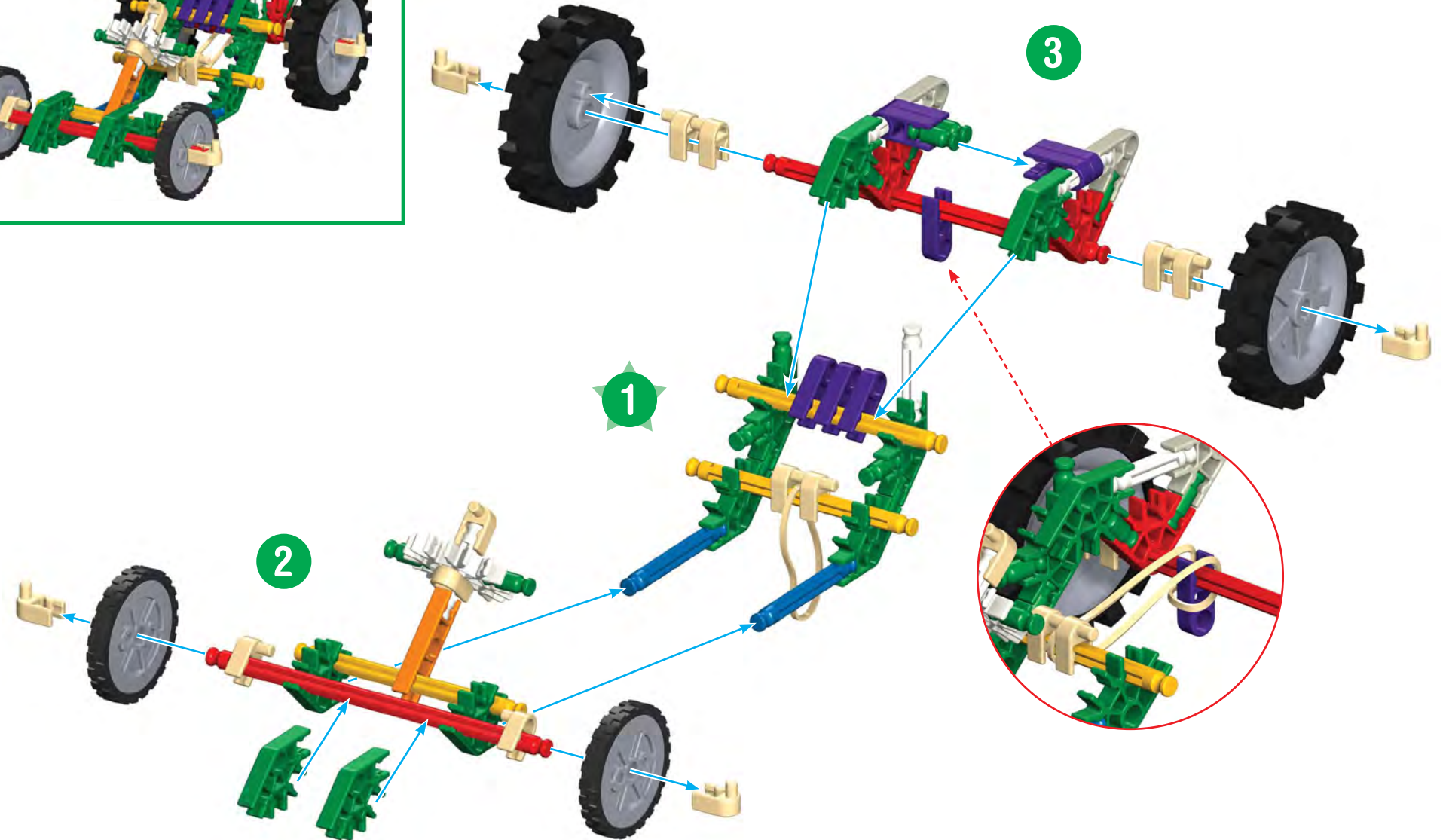
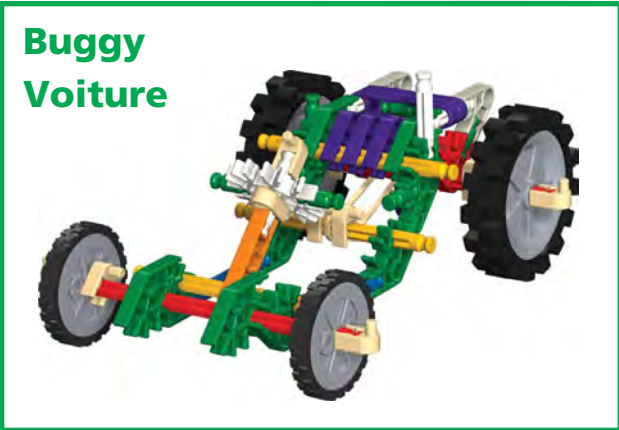

**Race Car
Racer**

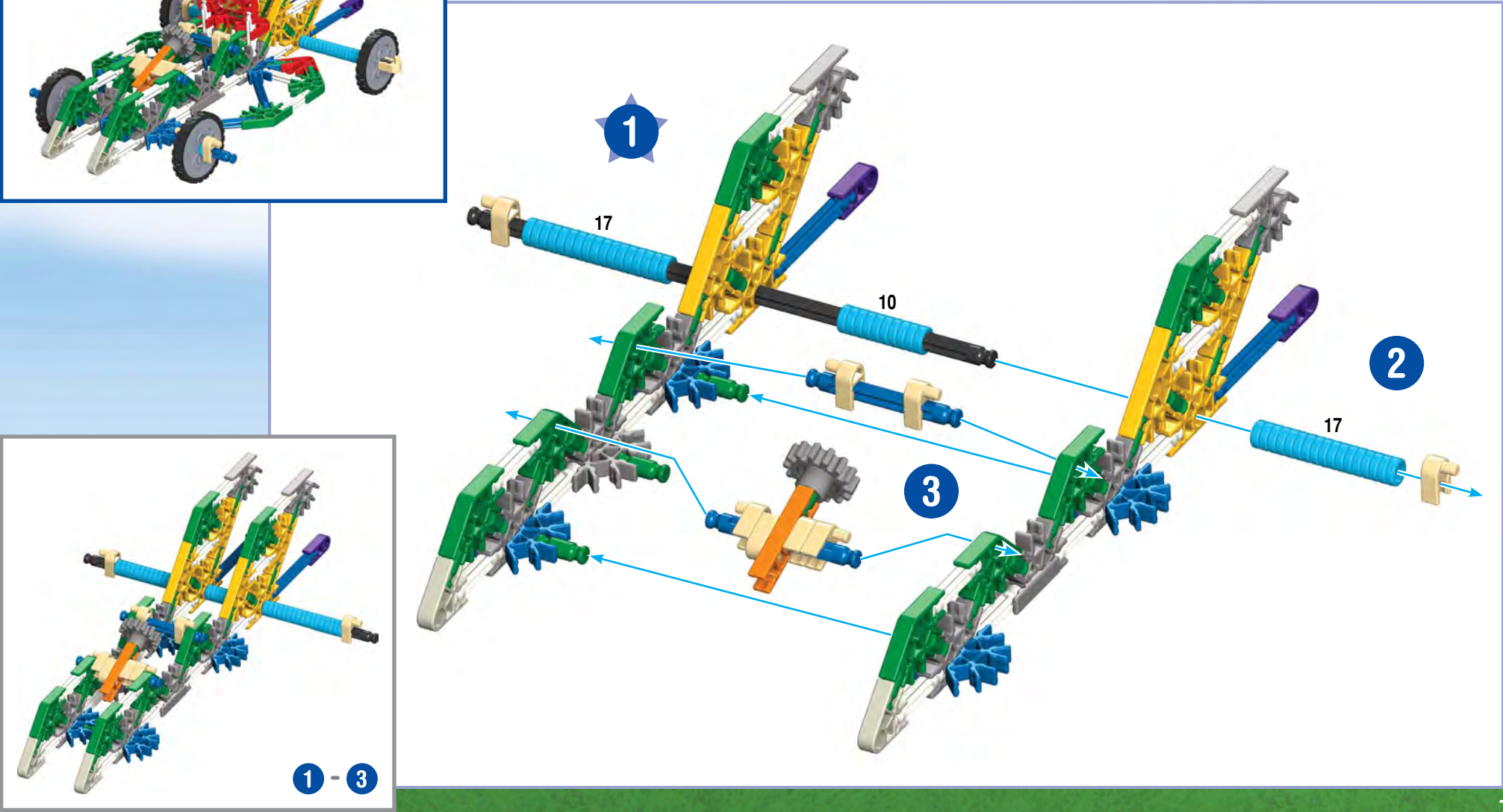

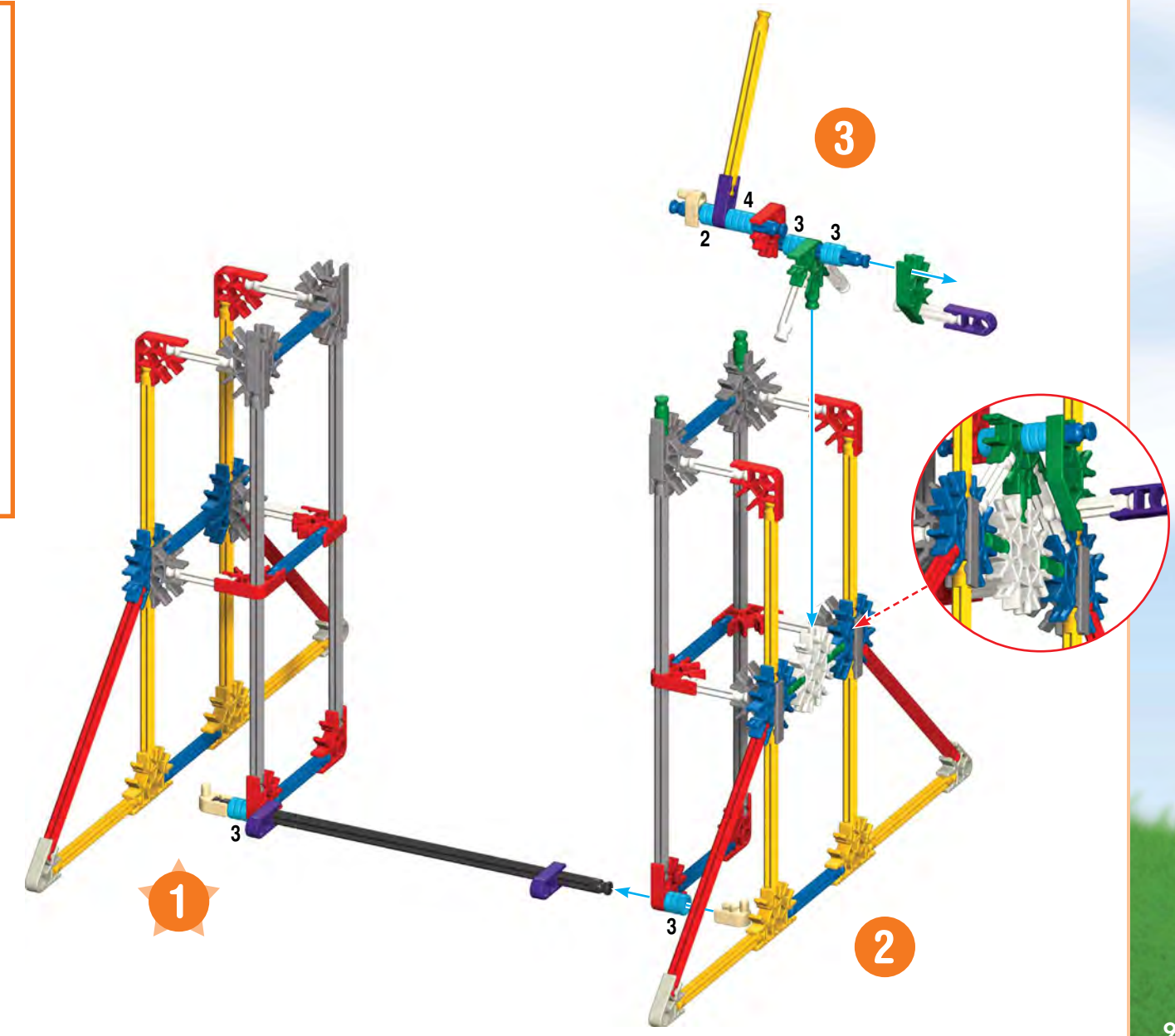
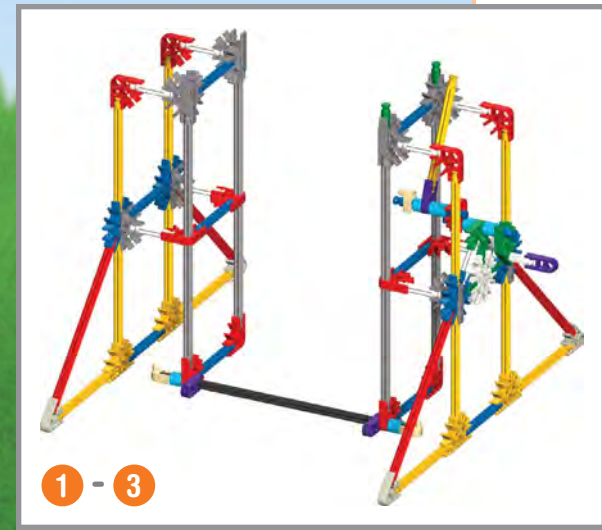
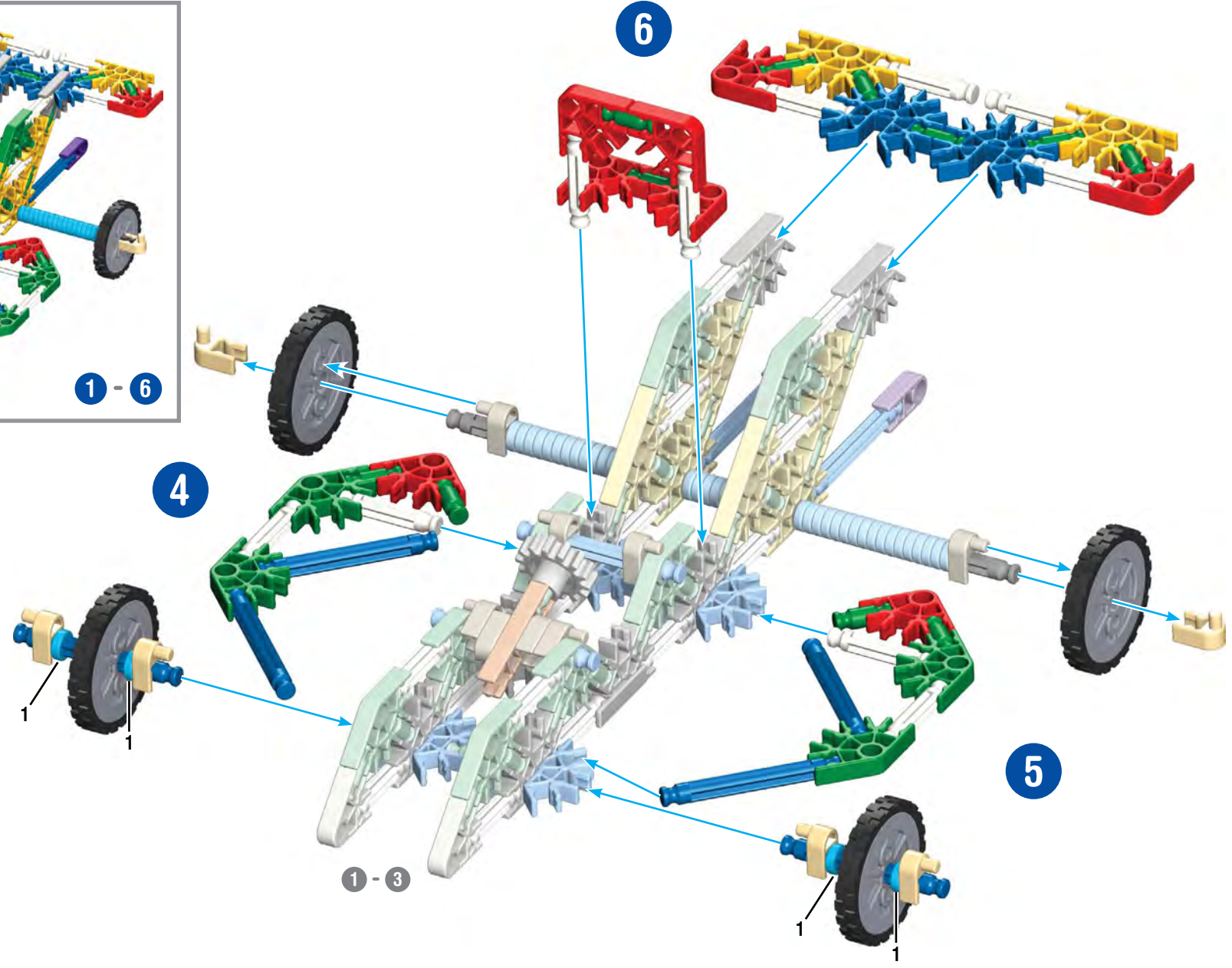
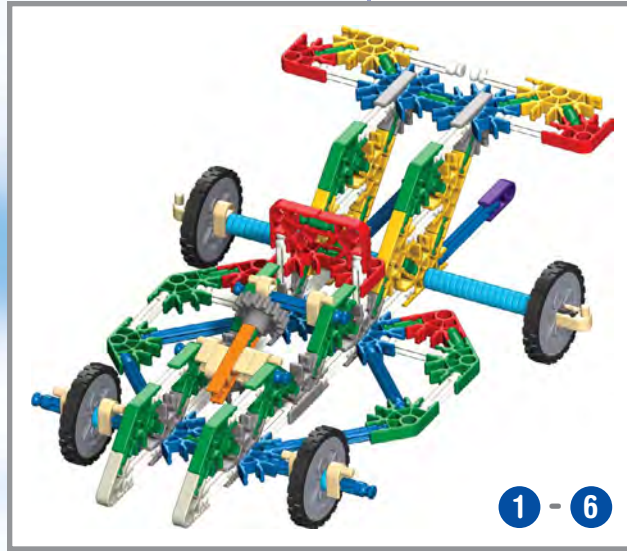

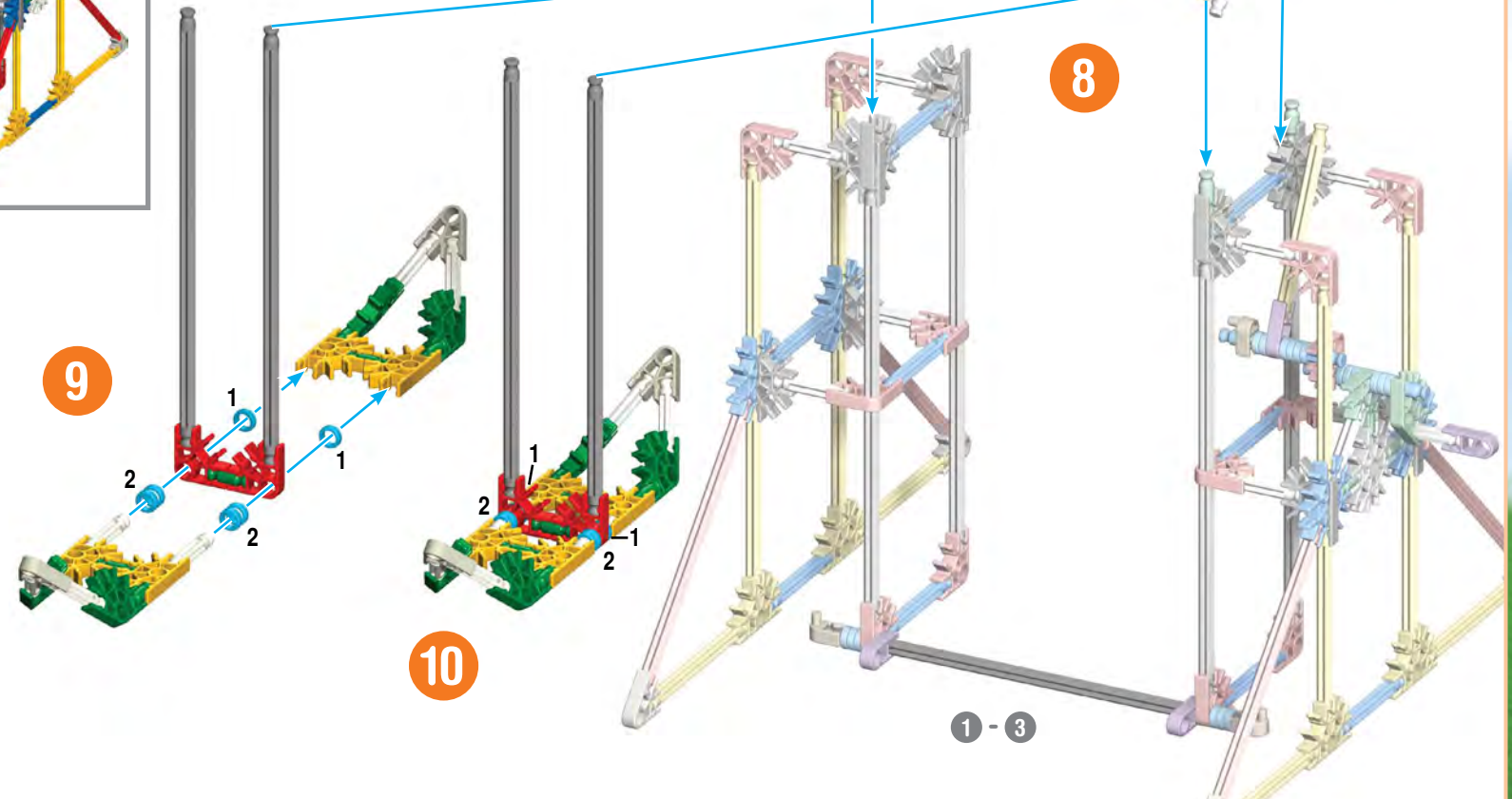
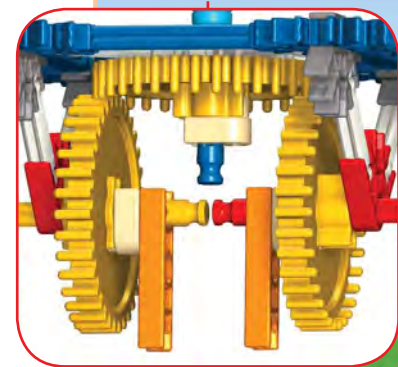
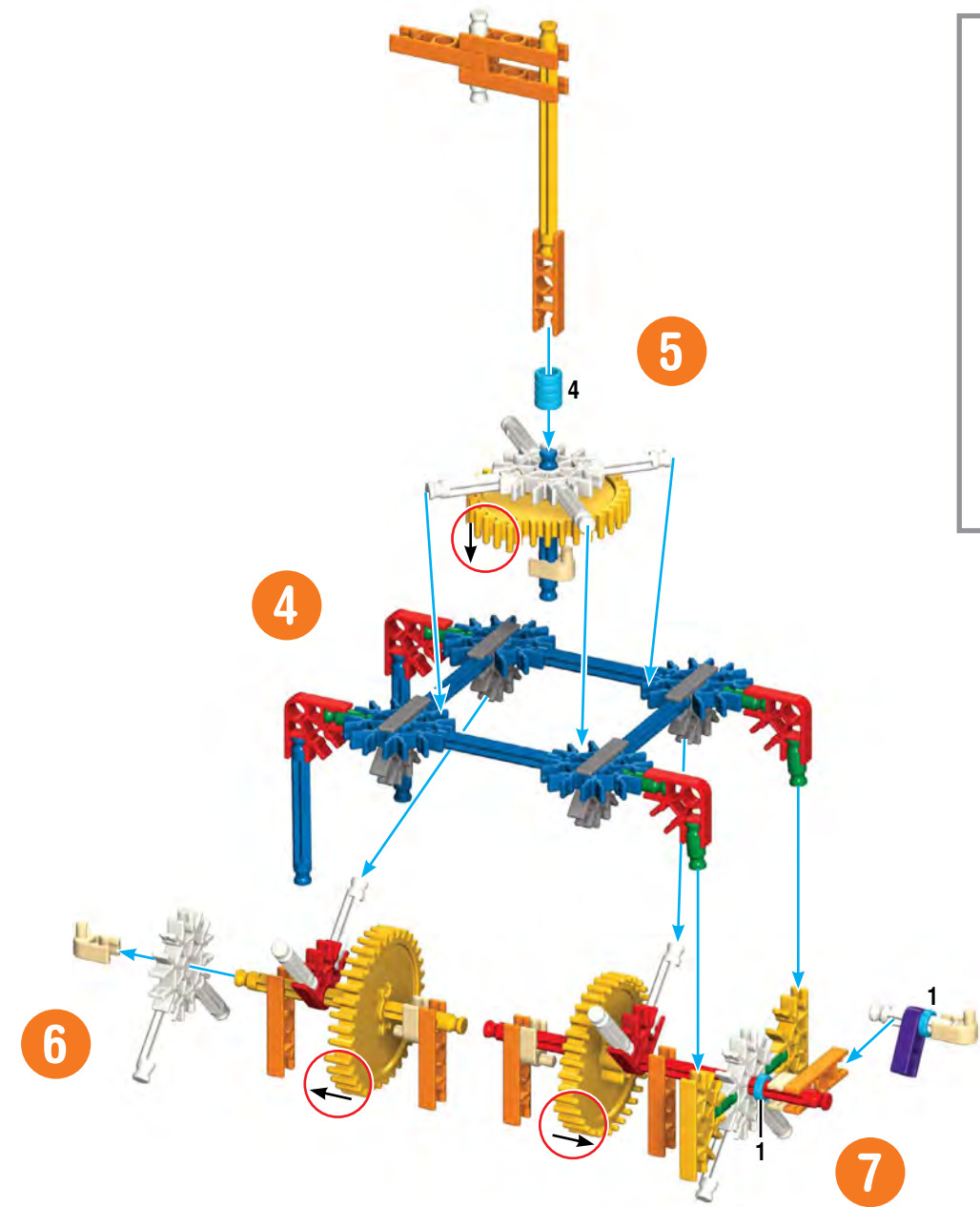

Crane
Grue

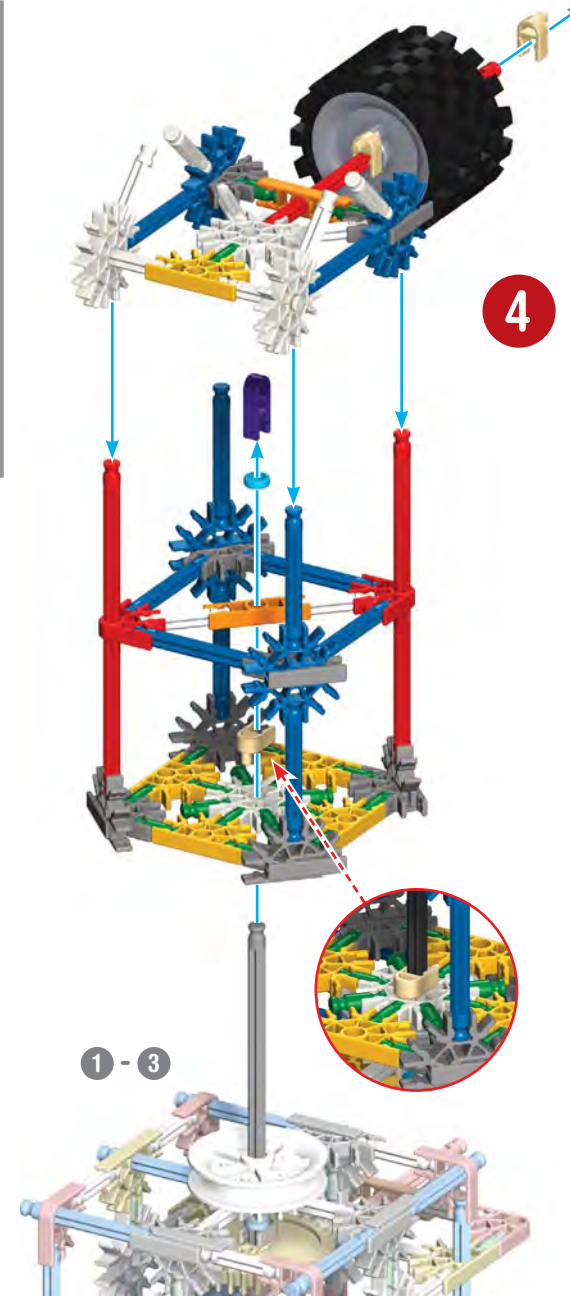
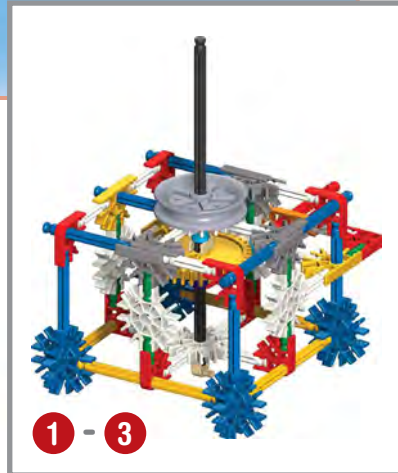
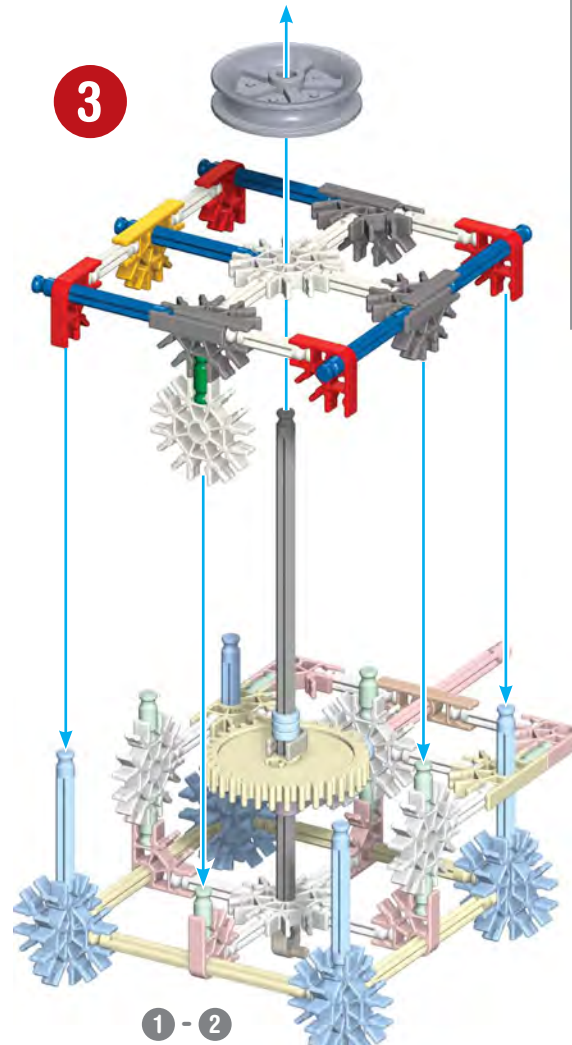
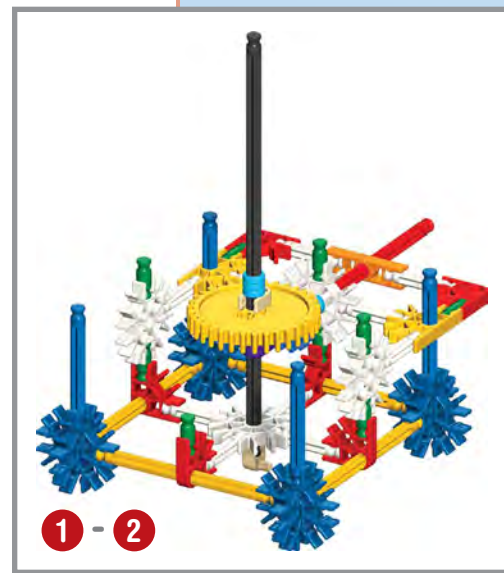
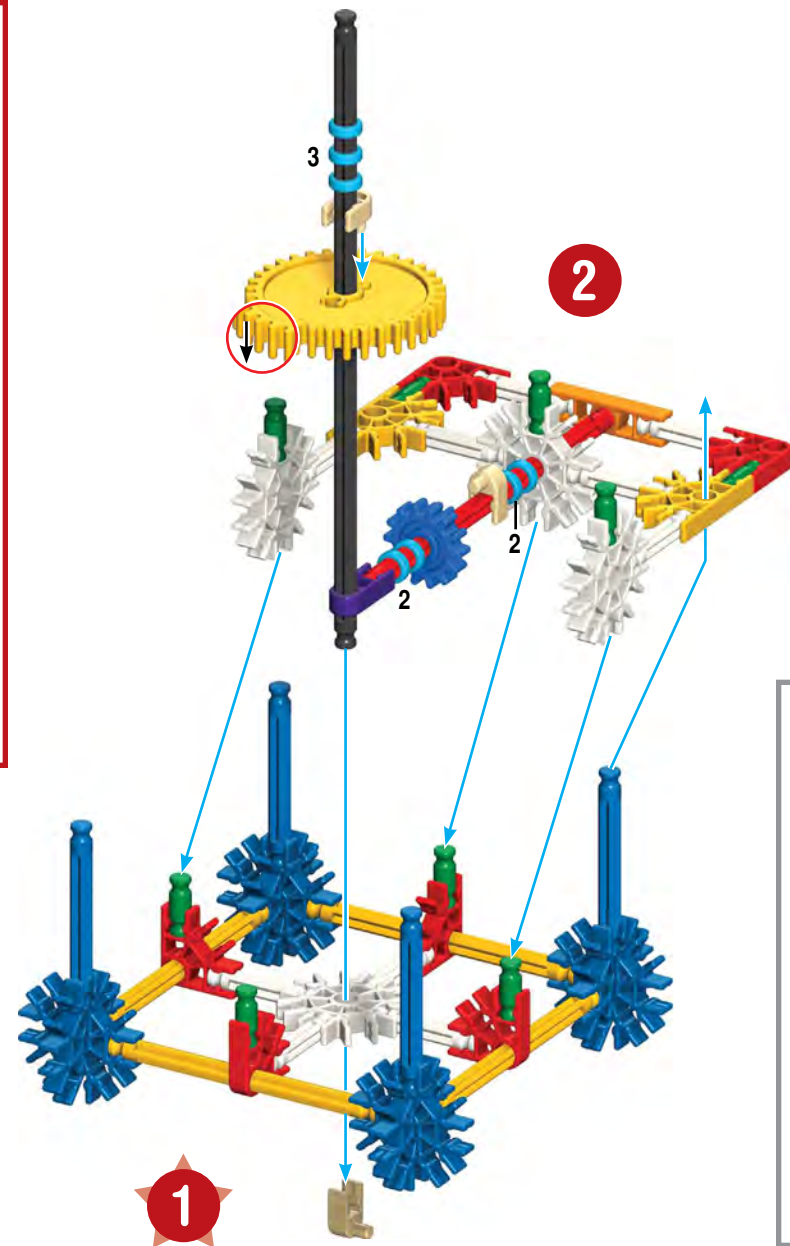

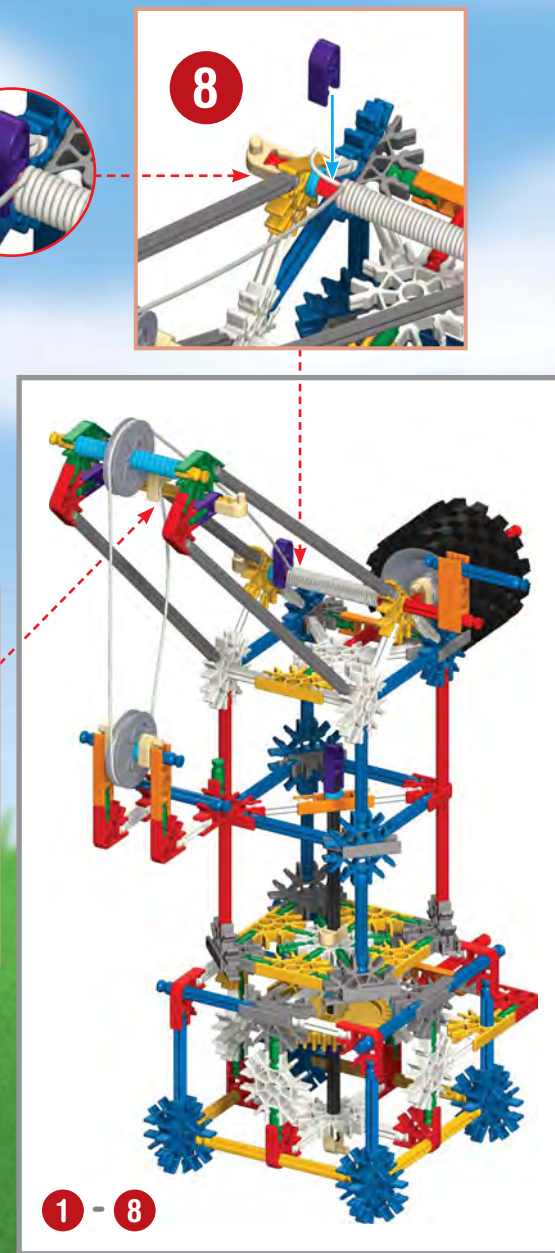
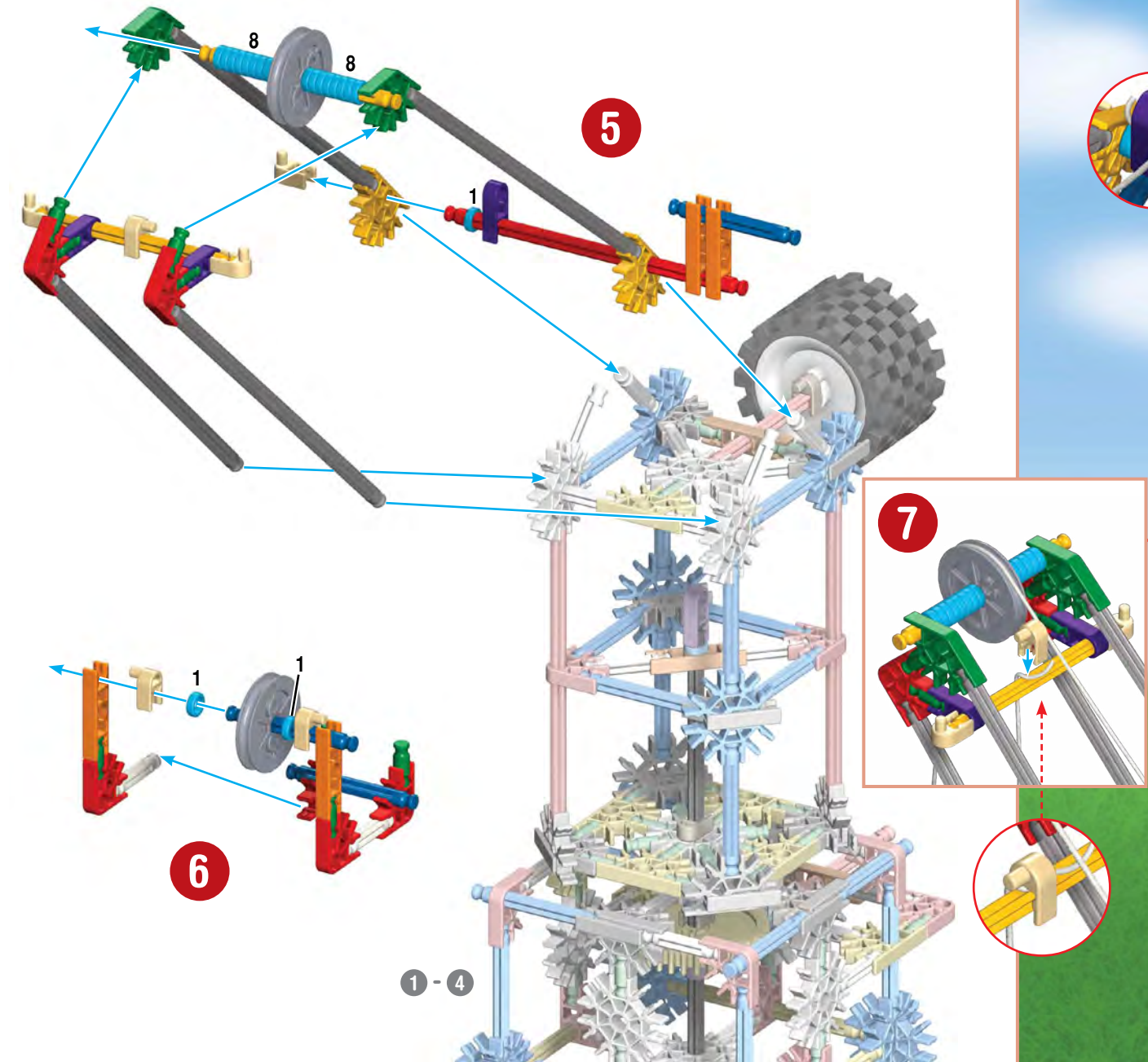

Helicopter

Hélicoptère

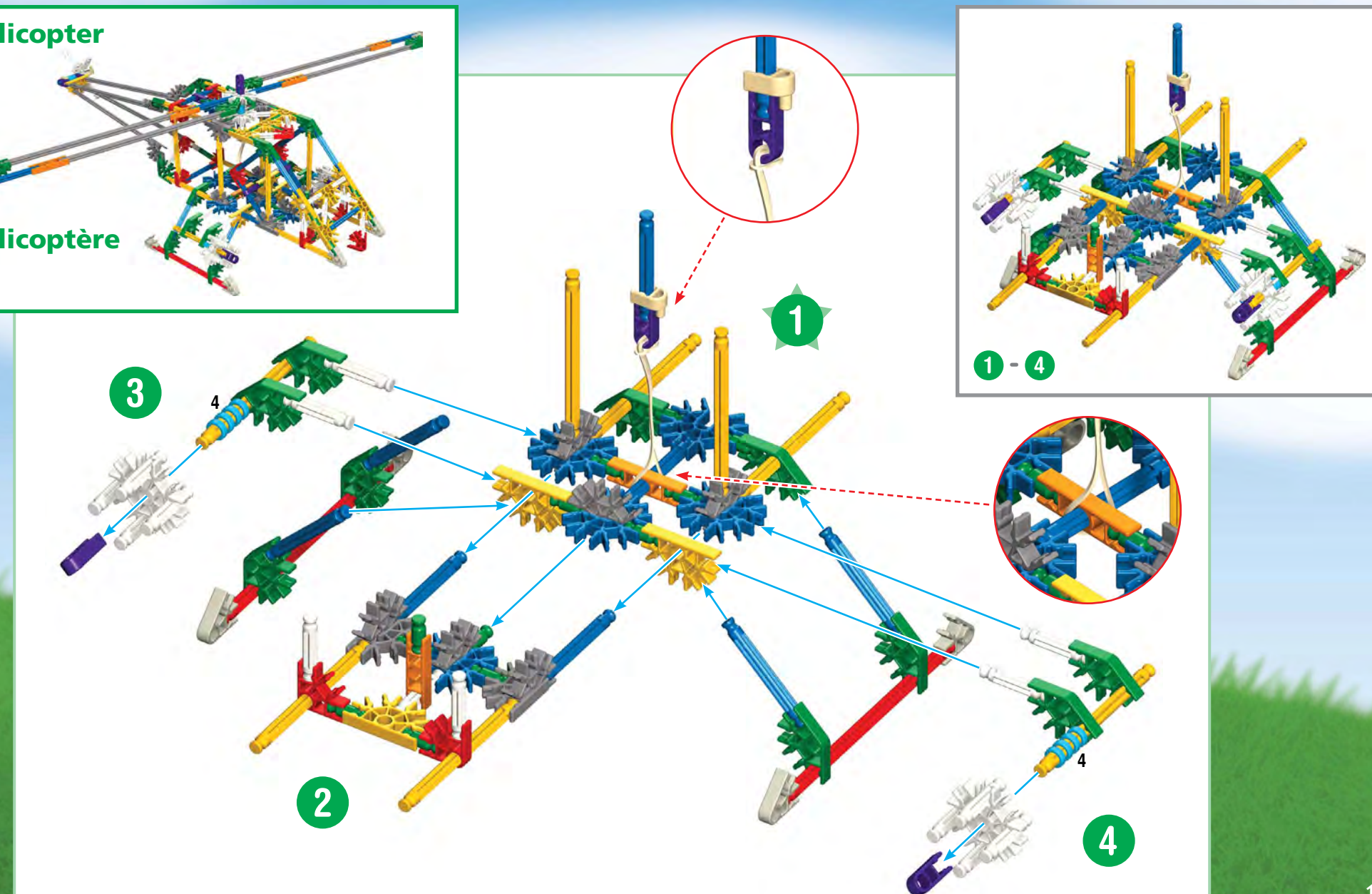
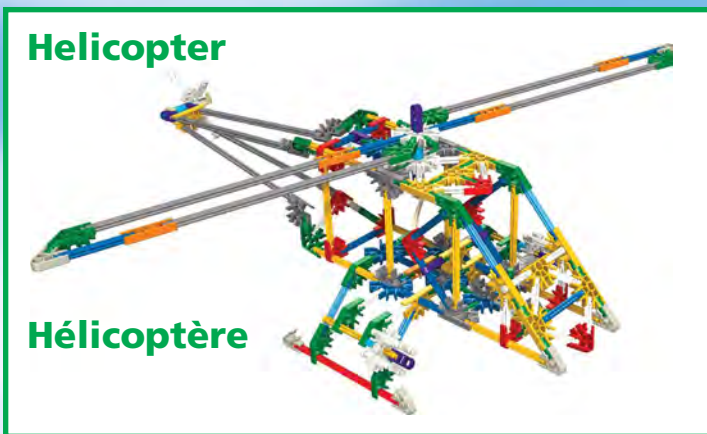

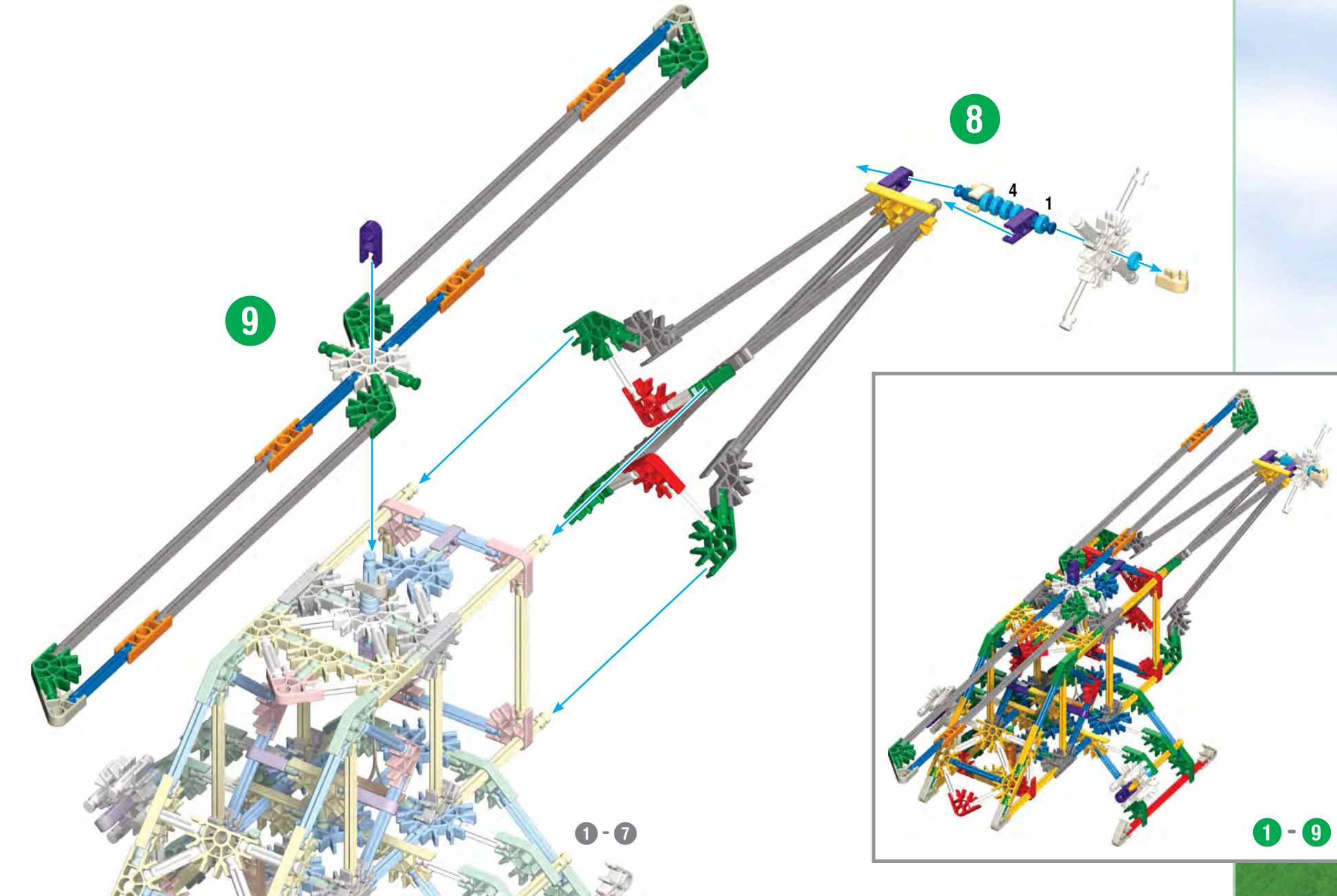
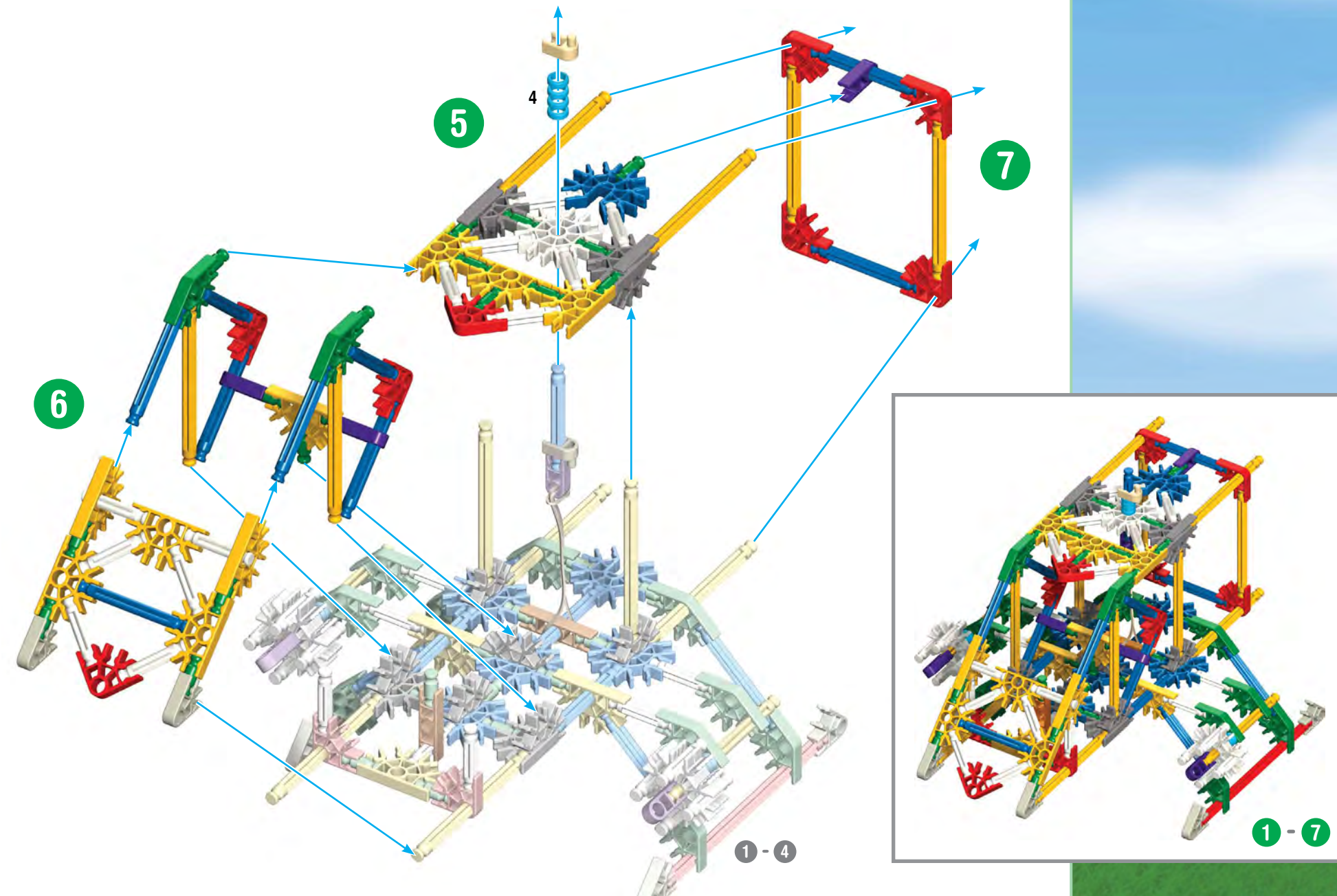

Box Bed Truck

Grand Camion de Boîte

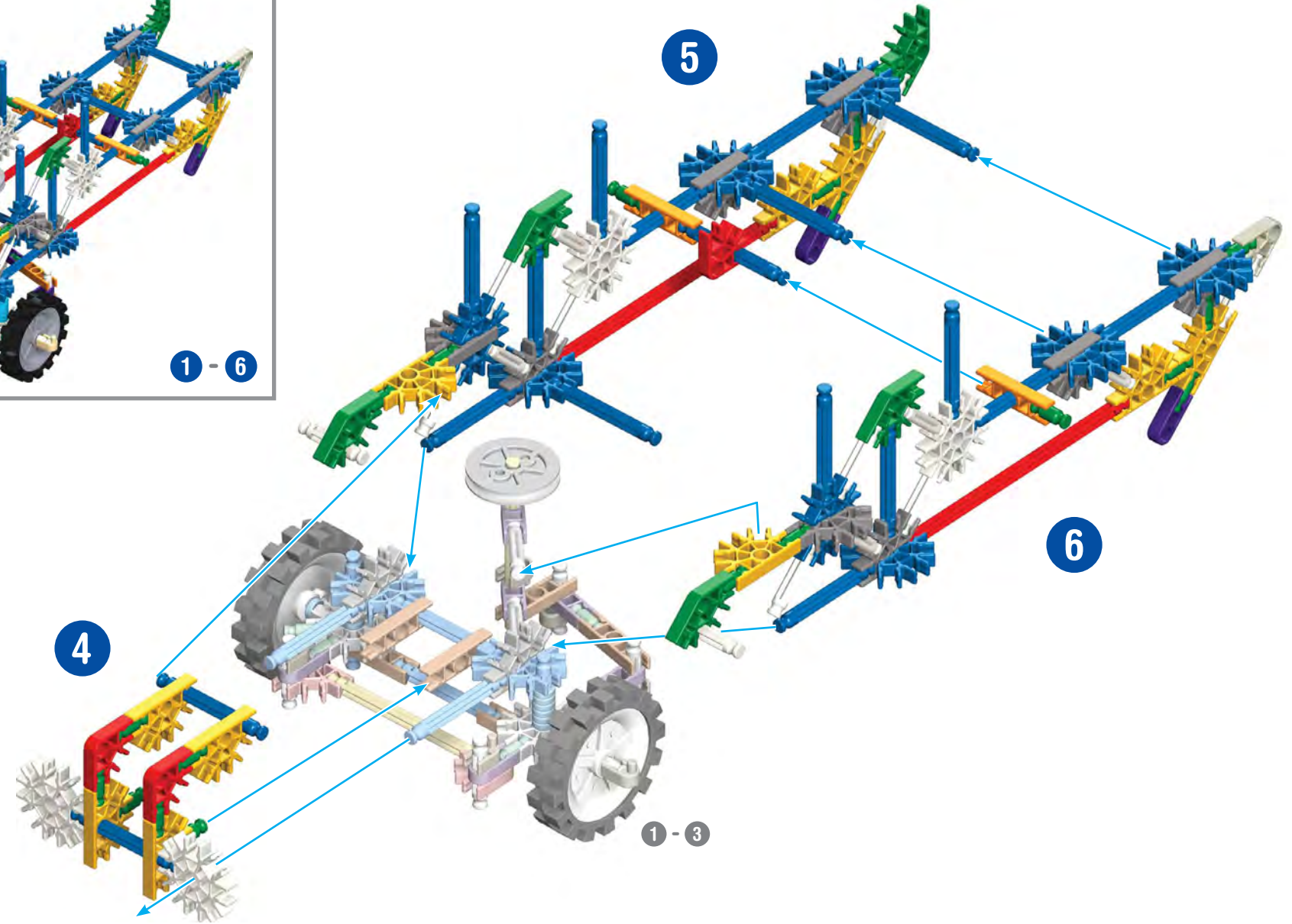
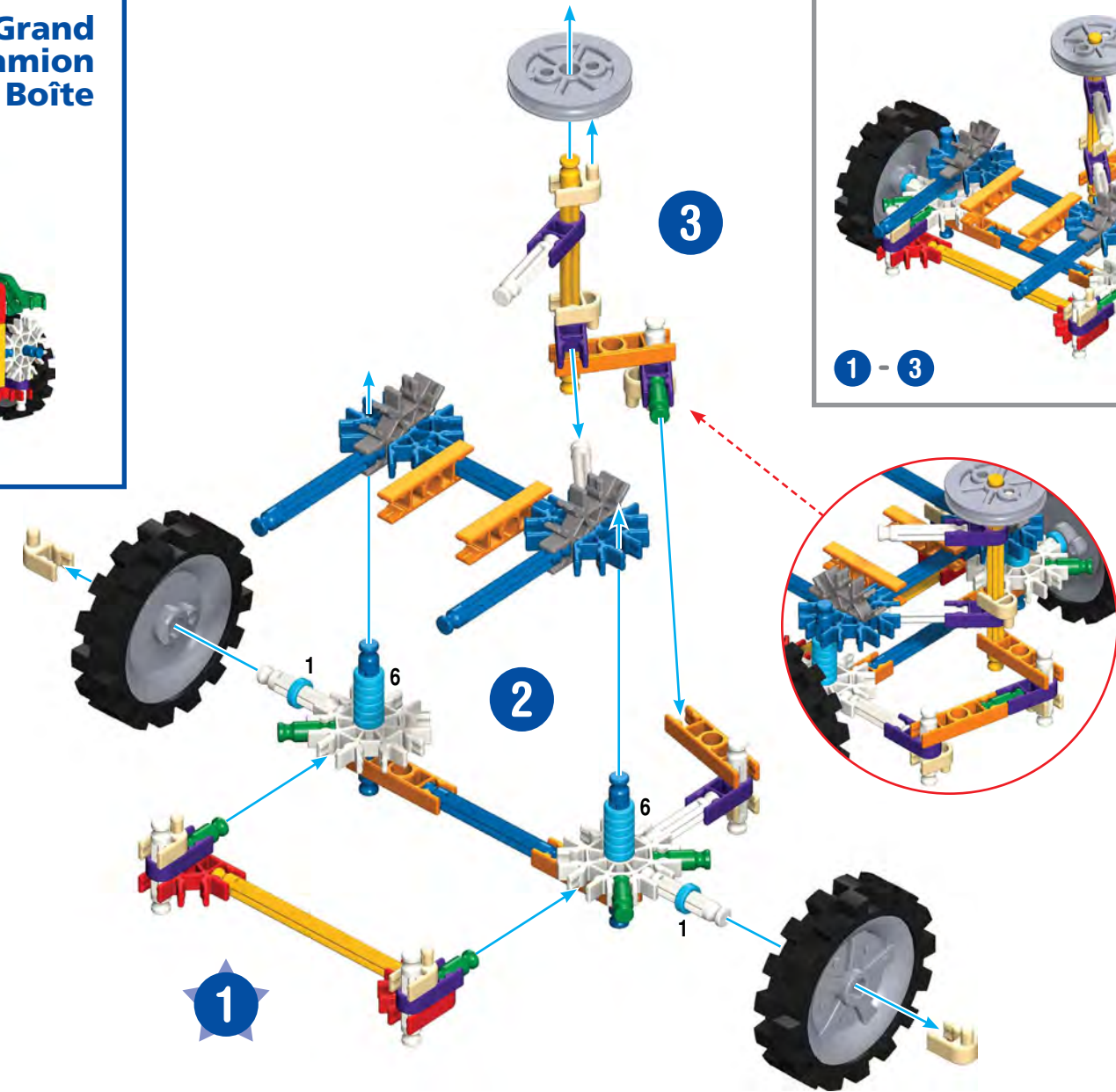

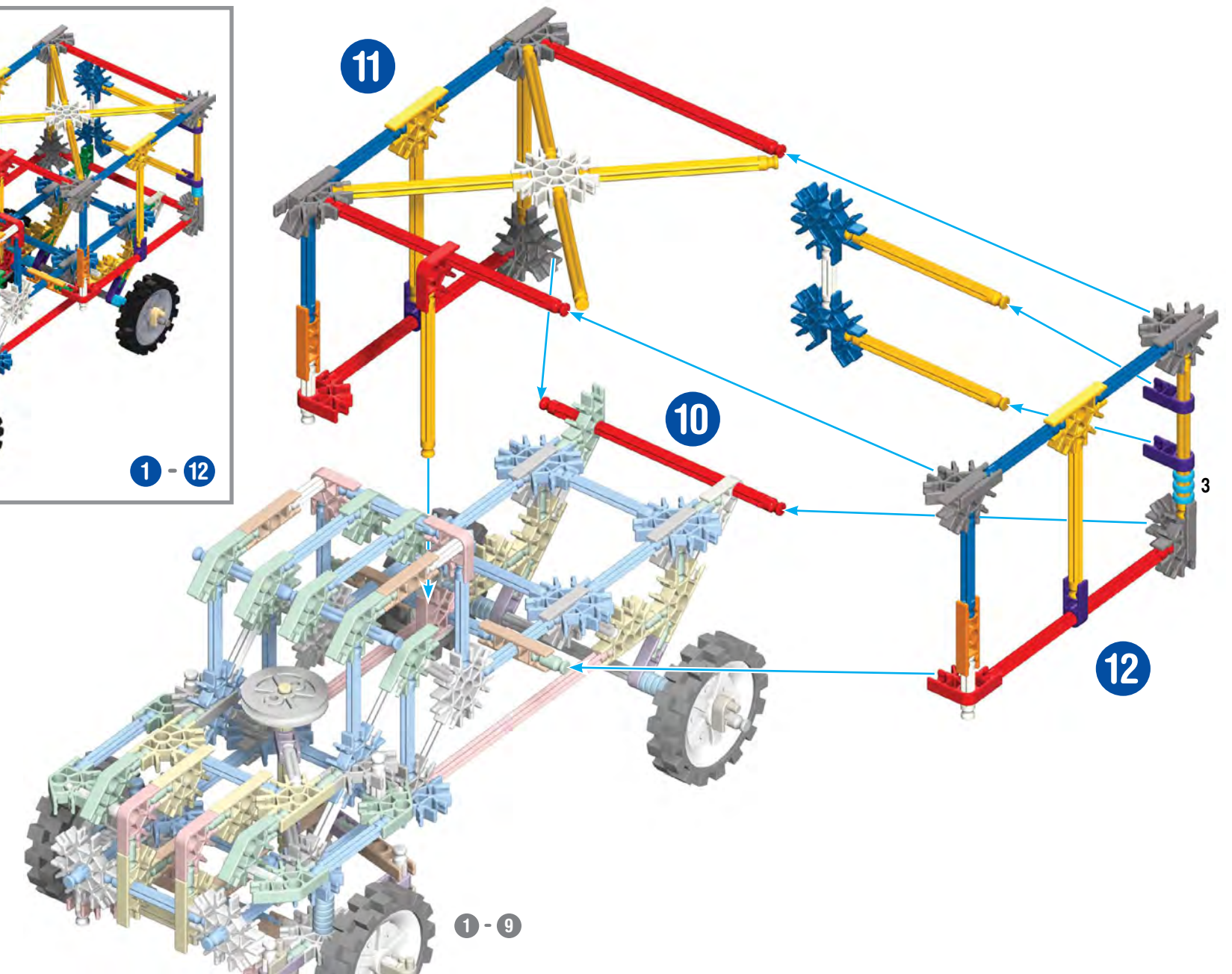
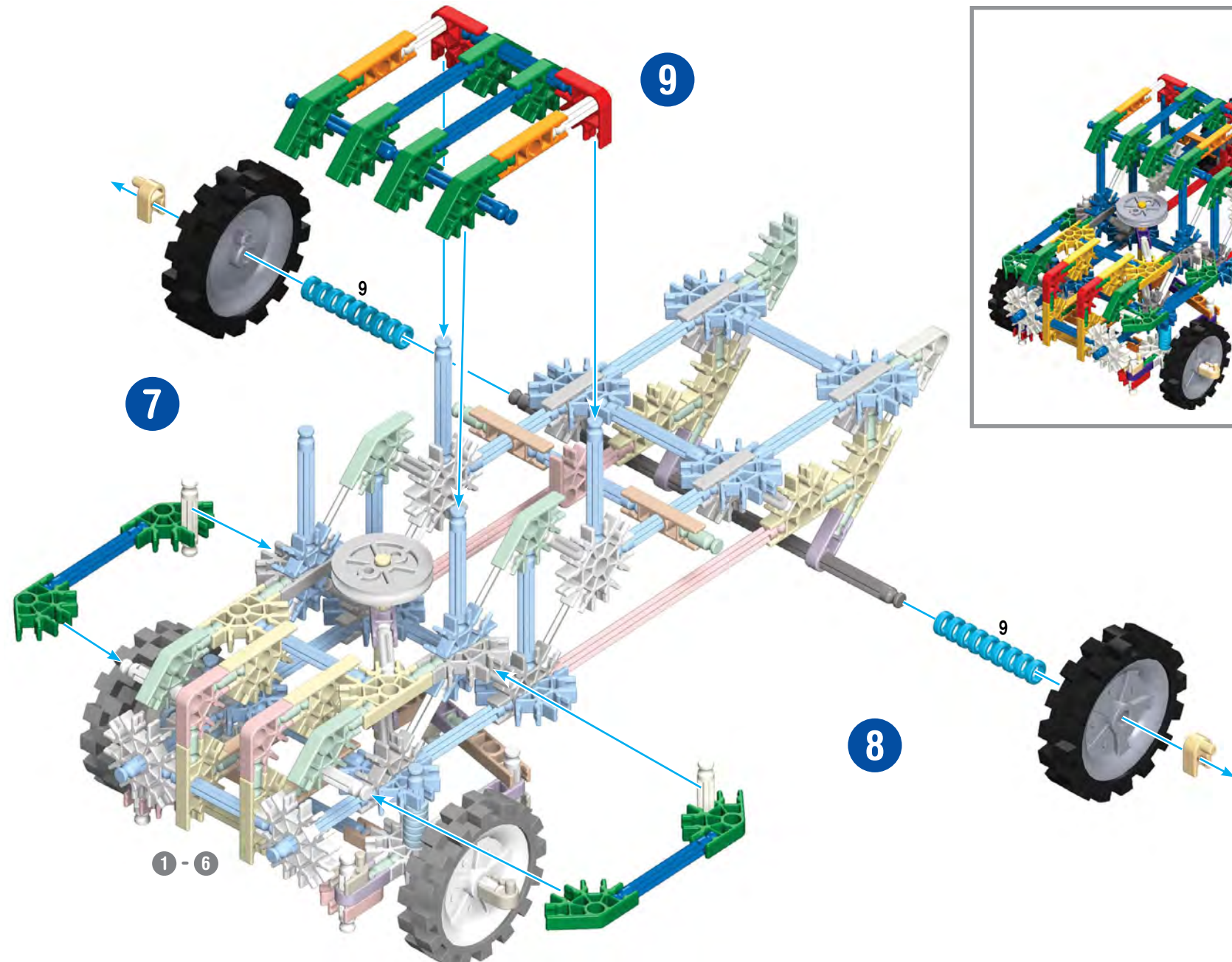

You can also build...

Vous pouvez aussi construire...

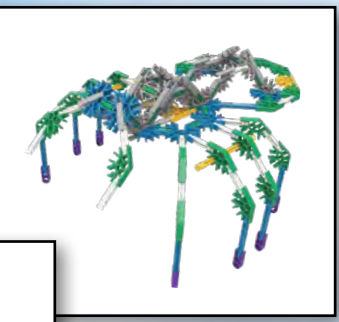
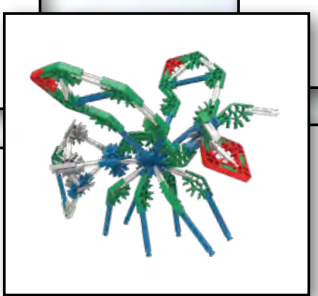
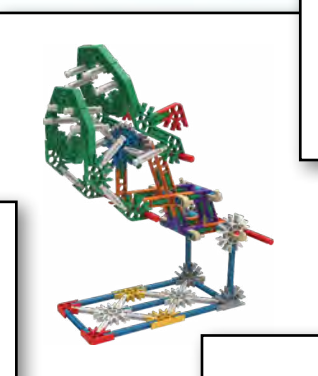
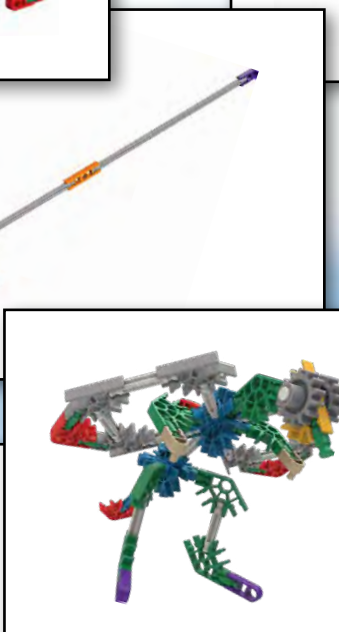
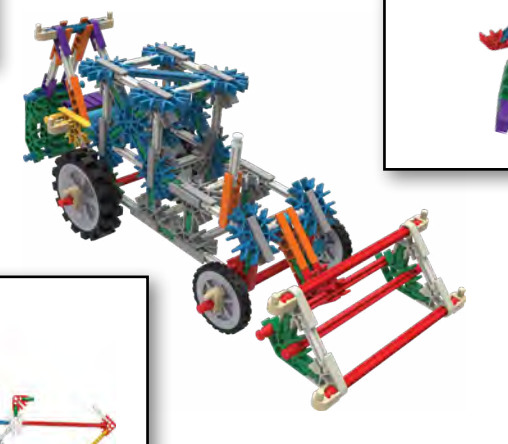
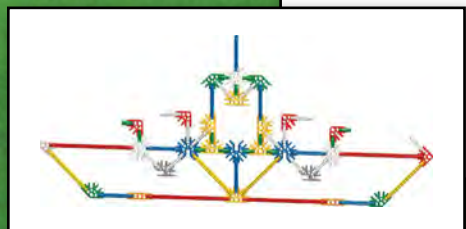
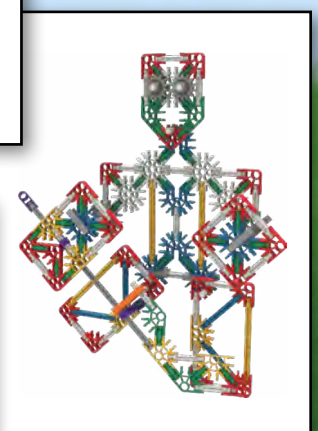
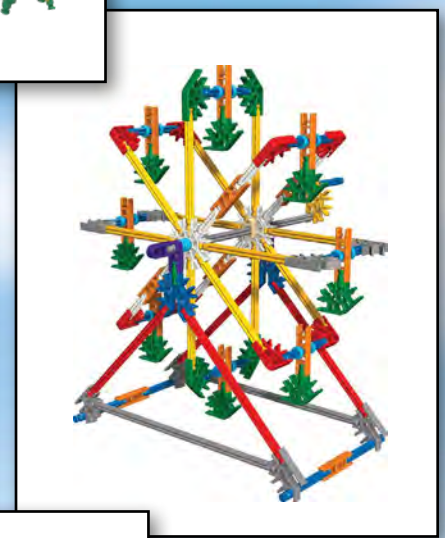
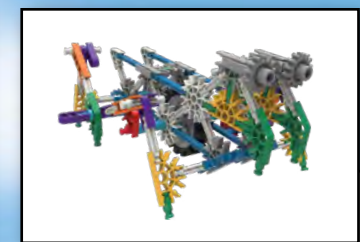
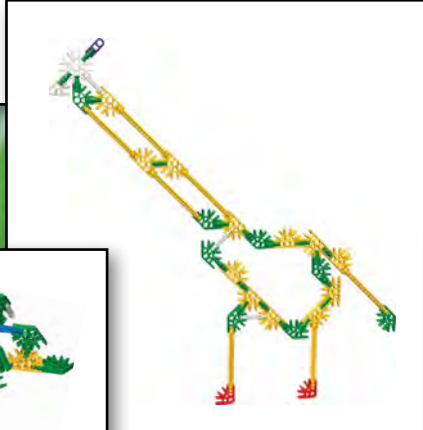
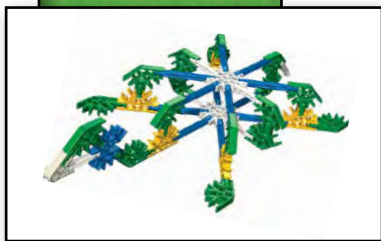
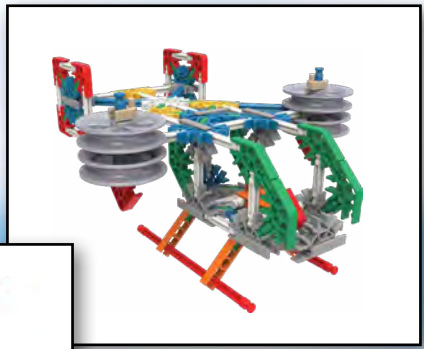
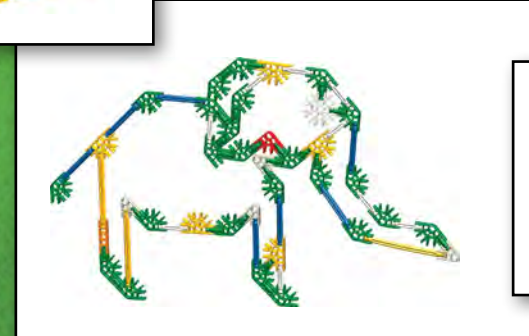
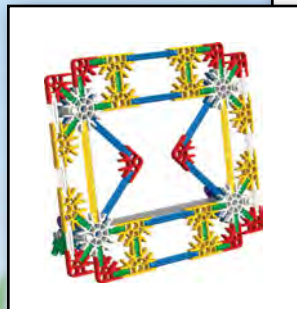

For instructions of these models go to knex.com/instructions and enter code 13687.

Car les instructions de ces modèles vont à knex.com/instructions et entrez dans le code 13687.

40 MODEL BUILDING SET 40 MODÈLE JEU DE CONSTRUCTION



©2013 K'NEX Limited Partnership Group, P.O. Box 700, Hatfield, PA 19440-0700 1-800-KID-KNEX (USA/Canada/États-Unis/EE.UU.); email@knex.com; www.knex.com. K'NEX and Building Worlds Kids Love are registered trademarks of K'NEX Limited Partnership Group. Product and colors may vary. Most models can be built one at a time. Customer outside the USA/Canada contact your local distributor at www.knex.com/distributors. (FR) K'NEX et Building Worlds Kids Love sont des marques déposées de K'NEX Limited Partnership Group. Produits et couleurs peuvent varier. La plupart des modèles ne peuvent être construits que un à un. Le Service clients hors États-Unis/Canada, s'il vous plaît contacter le distributeur local. L'information de distributeur peut être trouvée à www.knex.com/distributors (ES) K'NEX y Building Worlds Kids Love son marcas registradas de K'NEX Limited Partnership Group. El producto y los colores pueden variar. La mayoría de los modelos se pueden construir uno a la vez. El cliente que no vive en EE.UU./Canadá se pone en contacto con el distribuidor local. Encuentre la información para el distribuidor local en www.knex.com/distributors.

113687-V1-06/13

 knex.com/knexpert 

 facebook.com/buildknex

