

10-16

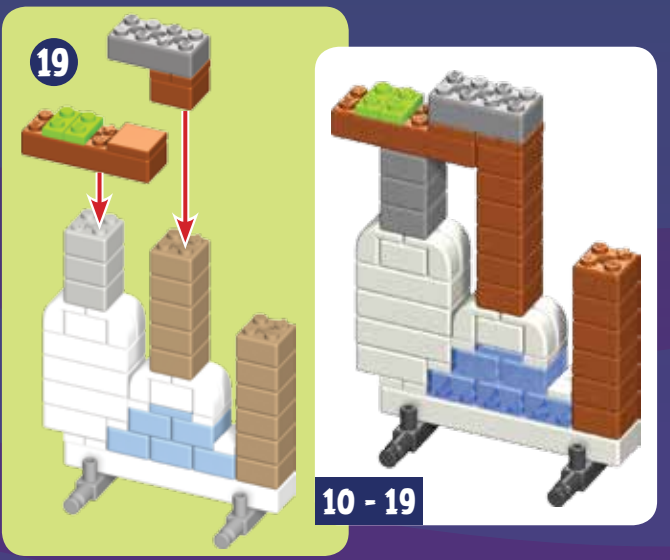

10-19

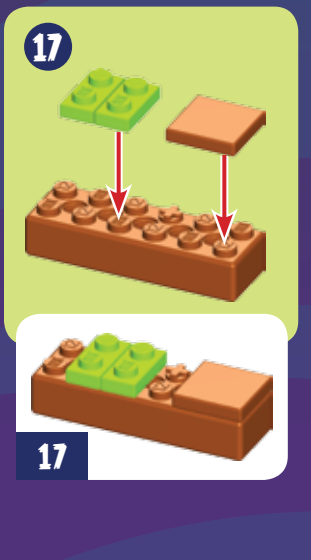
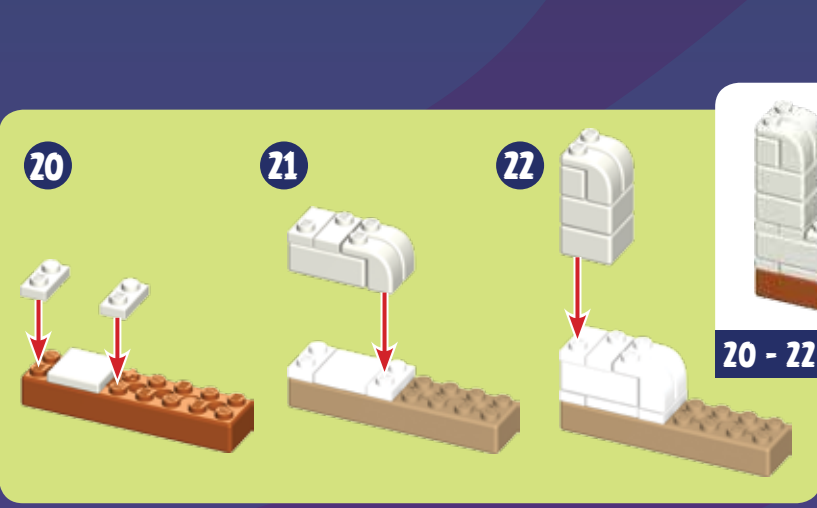

20-22

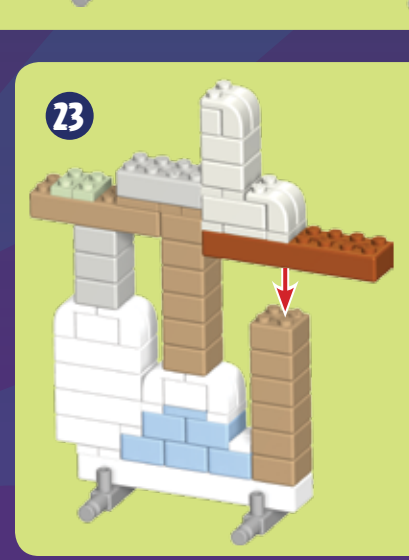

10-23



24

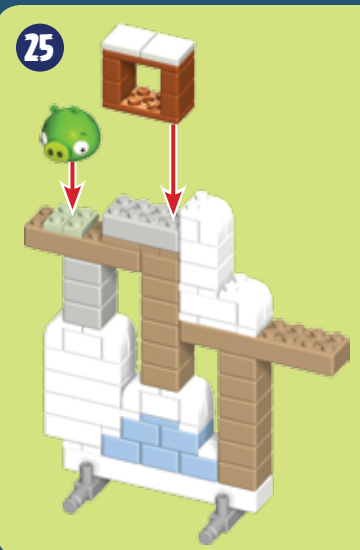

25



10 - 25

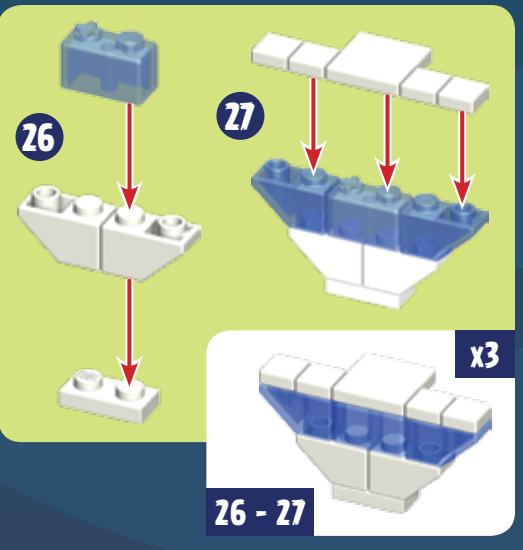

26

27

x3

26 - 27

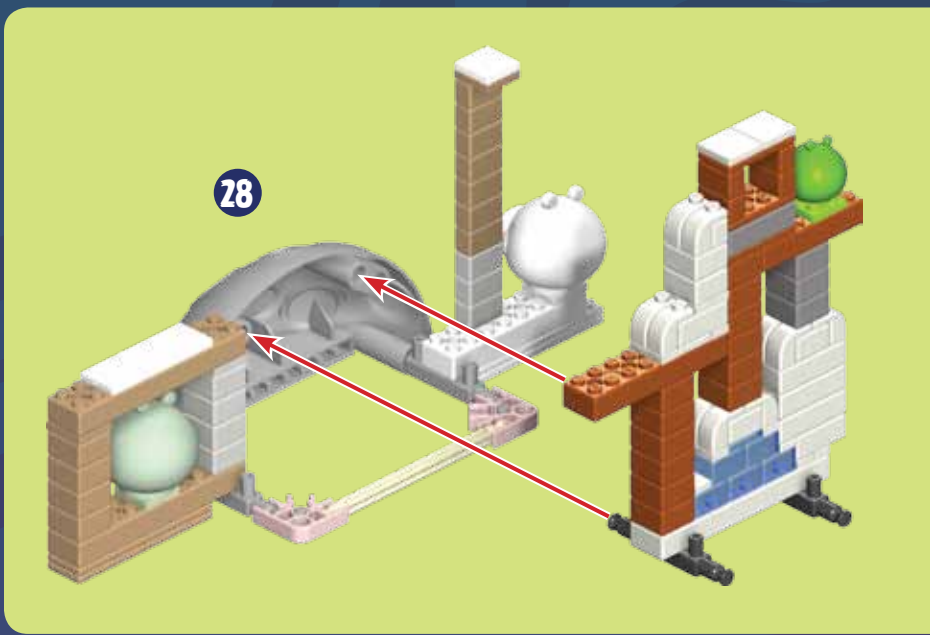

28



1 - 25, 28

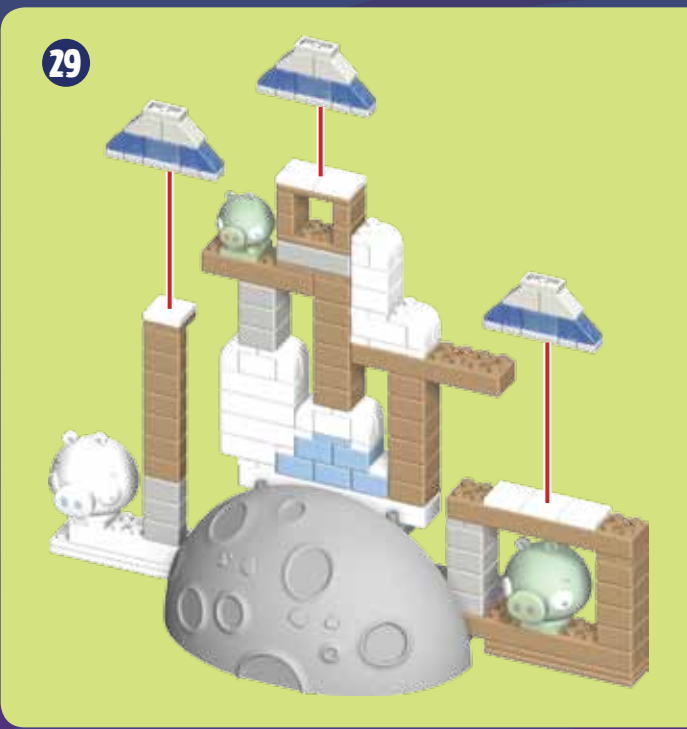

29



1 - 29

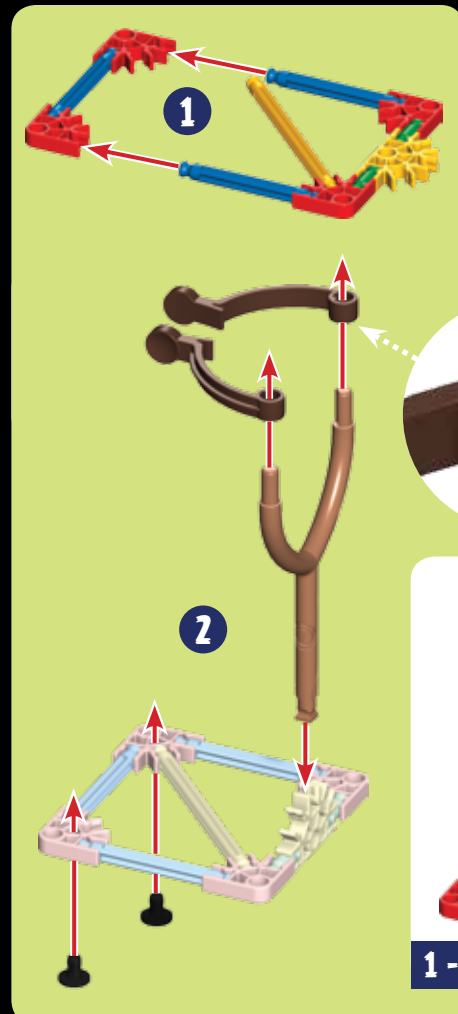

1

2

1 - 2

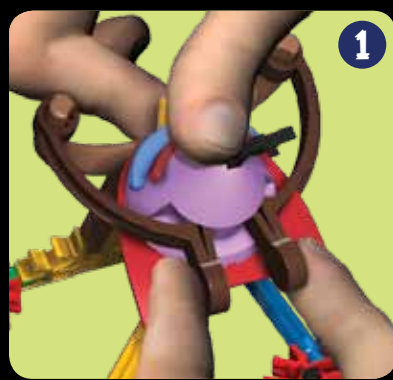

1



2

Pinch to Launch
Pincez pour Lancer!

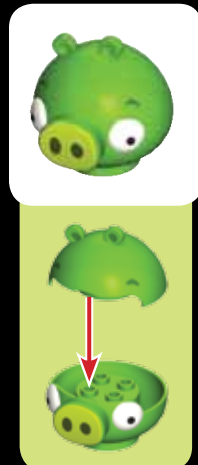

1

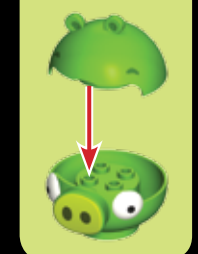

2

Bonus instructions at www.knex.com/angry-birds
Plans supplémentaires à www.knex.com/angry-birds
Instrucciones de la prima en www.knex.com/angry-birds
Zusätzliche Bauanleitungen bei www.knex.com/angry-birds
Bonus Istruzioni a www.knex.com/angry-birds
Instruções do bônus em www.knex.com/angry-birds
De instructies van de bonus bij www.knex.com/angry-birds
Bonus instruksjoner på www.knex.com/angry-birds
Bonus instruksjonene på www.knex.com/angry-birds
Bonus ohjeita www.knex.com/angry-birds
Bonus anvisninger på www.knex.com/angry-birds
Bónus leiðbeiningar á www.knex.com/angry-birds

(EN) Product & colors may vary.
(FR) Produits et couleurs peuvent varier.
(ES) El producto y los colores pueden variar.
(DE) Produkte und Farben können variieren.
(IT) Prodotti e colori possono differire.
(PT) O produto e as cores podem variar.
(NL) Product en kleuren kunnen variëren.
(SE) Produkter och färger kan variera.
(NO) Produkter og farger kan variere.
(FI) Tuotteet ja värit saattavat vaihdella.
(DK) Produkter og farver kan variere.
(IS) Hlutir og litir geta verið breytilegir.

WARNING: CHOKING HAZARD – Toy contains a SMALL BALL and SMALL PARTS. Not for children under 3 years.
ATTENTION ! RISQUE D'ÉTOUFFEMENT – Jouet contient une petite boule et pièces de petite taille. Ne convient pas aux enfants de moins de 3 ans.

ADVERTENCIA: PELIGRO DE ASFIXIA – Juguete contiene una pequeña bola y piezas pequeñas. No recomendado para niños menores de 3 años.

WARNUNG: ERSTICKUNGSGEFAHR – Spielzeug enthält einen kleinen Ball und Kleinteile. Nicht für Kinder unter 3 Jahren.

AVVISO: PERICOLO DI SOFFOCARE – Giocattolo a una piccola pallina e pezzi piccoli. Non adatto per bambini sotto 3 anni.

AVISO: PERIGO DE SUFOCACÃO – Toy contém uma pequena bola e peças pequenas. Não indicado para crianças menores de 3 anos.

WAARSCHUWING: VERSTIKKINGSGEVAAR – Toy bevat een kleine bal en kleine onderdelen. Niet voor kinderen onder de 3 jaar.

VARNING: KVVÄNNINGSRISK – Innehåller liten boll och små delar. Inte för barn under 3 år.

ADVÆRSEL: KVELNINGSFARE – Leken inneholder en liten ball og små deler. Ikke egnet for barn under 3 år.

VAROITUS: TUKEHTUMISVAARA – Lelu sisältää pienen pallon ja pieniä osia. Ei sovelle alle 3-vuotiaille lapsille.

ADVÆRSEL: INDEHOLDER SMÅ DELE – Dette legetøj inkluderer en lille bold og andre smådele. Ikke egnet til børn under 3 år.

ADVÖRÜN: KÖFNUNARHÆTTA – Leikfangið inniheldur lítinn bolta og lítil hluti. Ekki fyrir börn undir 3ja ára.

CAUTION: Do not launch in the direction of people, animals, or walls; You could cause injury or damage.

PRECAUCIÓN: No lance en dirección de gente, de animales, o de paredes; Usted podría estropear lesión o.

ATTENTION : Ne lancez pas dans la direction des personnes, des animaux, ou des murs ; Vous pourriez endommager des dommages ou.

VORSICHT: Starten Sie nicht in Richtung der Leute, der Tiere oder der Wände; Sie könnten Verletzung oder Schaden verursachen.

AVVERTENZA: Non lanci in direzione della gente, degli animali, o delle pareti; Potreste causare la lesione o il danno.

CUIDADO: Não lanc no sentido dos povos, dos animais, ou das paredes; Você poderia causar ferimento ou dano.

VOORZICHTIGHEID: Lanceer niet in de richting van mensen, dieren, of muren; U kon verwonding of schade veroorzaken.

VARNING: Sikta inte mot människor, djur eller väggar. Risk för skada eller äverkan.

FORSIKTIG: Ikke skyt mot mennesker, dyr eller vegger. Det kan forårsake skade.

VAROITUS: Älä ammu kohti ihmisiä, eläimiä tai seinäiä kohti. Voi aiheuttaa vammoja tai vahinkoa.

ADVÆRSEL: Skyd ikke i retning af mennesker, dyr samt vægge! Du kan forårsage skader!

ADVÖRÜN: Skjöttu ekki í átt að fólki, dýrum eða veggjum; Þú getur valdið slysum.

¡Pizca para Lanzar!
Zusammendrücken zum schliessen!
Pizzicare per lanciare!
Beliscar para Lançar!
Knijpen om te Starten!
Nyp för att avfyra!
Trykk for å starte!
Laukaise nipistämällä!
Træk ved affyring!
Spennni teygjuna til að skjóta!

facebook.com/buildknex



- Identifies Genuine K'NEX Bricks.
- Identifie que ce sont d'authentiques briques K'NEX.
- Identifica los ladrillos genuinos de K'NEX.
- Identifiziert echte K'NEX-Bausteine.
- Edentifica i veri blocchi K'NEX.
- Identifica que são cubos genuinos da K'NEX.
- Identificeert Genuine K'NEX bakstenen voor.
- Innehåller K'NEX originalklossar.
- Identifiserer ekte K'NEX-brikker.
- Aidot K'NEX pallikat.
- Garanteret ægte K'NEX dele.
- Hægt að nota með öðrum K'NEX kubbum.



WARNING : CHOKING HAZARD - Small parts. Not for children under 3 years.
ATTENTION ! RISQUE D'ÉTOUFFEMENT. Pièces de petite taille. Ne convient pas aux enfants de moins de 3 ans.

7+

ROVIO

ANGRY BIRDS IS A TRADEMARK OF ROVIO ENTERTAINMENT LTD. ALL RIGHTS RESERVED. COPYRIGHT © 2009-2012 ROVIO ENTERTAINMENT LTD. ALL RIGHTS RESERVED.

WWW.ANGRYBIRDS.COM

ANGRY BIRDS ES UNA MARCA DE ROVIO ENTERTAINMENT LTD. TODOS LOS DERECHOS RESERVADOS. © 2009-2012 ROVIO ENTERTAINMENT LTD. TODOS LOS DERECHOS RESERVADOS.

ANGRY BIRDS EST UNE MARQUE DÉPOSÉE DE ROVIO ENTERTAINMENT LTD. TOUS DROITS RÉSERVÉS. © 2009-2012 ROVIO ENTERTAINMENT LTD. TOUS DROITS RÉSERVÉS.



Tomy UK Ltd.
Totton, Hants
SO40 3SA, England

172401-V1-11/12