

WARNING: CHOKING HAZARD – Toy contains a SMALL BALL and SMALL PARTS. Not for children under 3 years.
ATTENTION ! RISQUE D'ÉTOUFFEMENT – Jouet contient une petite boule et pièces de petite taille. Ne convient pas aux enfants de moins de 3 ans.
ADVERTENCIA: PELIGRO DE ASFIXIA – Juguete contiene una pequeña bola y piezas pequeñas. No recomendado para niños menores de 3 años.
WARNUNG: ERSTICKUNGSGEFAHR – Spielzeug enthält einen kleinen Ball und Kleinteile. Nicht für Kinder unter 3 Jahren.
AVVISO: PERICOLO DI SOFFOCARE – Giocattolo a una piccola pallina e pezzi piccoli. Non adatto per bambini sotto 3 anni.
AVISO: PERIGO DE SUFOCAÇÃO – Toy contém uma pequena bola e peças pequenas. Não indicado para crianças menores de 3 anos.
WAARSCHUWING: VERSTIKKINGSGEVAAR – Toy bevat een kleine bal en kleine onderdelen. Niet voor kinderen onder de 3 jaar.
VAROITUS: KIVÄNNINGSRISK – Innehåller liten boll och små delar. Inte för barn under 3 år.
ADVARSEL: KVELNINGSFARE – Leken inneholder en liten ball og små deler. Ikke egnet for barn under 3 år.
VAROITUS: TUKEHTUMISVAARA – Lelu sisältää pienen pallon ja pieniä osia. Ei soveltu alle 3-vuotiaille lapsille.
ADVARSEL: INDEHOLDER SMÅ DELE – Dette legetøj inkluderer en lille bold og andre smådele. Ikke egnet til børn under 3 år.
ADVÖRUN: KÖFNUNARHÆTTA – Leikfangið inniheldur lítinn bolta og litla hluti. Ekki fyrir börn undir 3ja ára.

CAUTION: Do not launch in the direction of people, animals, or walls; You could cause injury or damage.
PRECAUCIÓN: No lance en dirección de gente, de animales, o de paredes; Usted podría estropear lesión o.
ATTENTION : Ne lancez pas dans la direction des personnes, des animaux, ou des murs ; Vous pourriez endommager des dommages ou.
VORSICHT: Starten Sie nicht in Richtung der Leute, der Tiere oder der Wände; Sie könnten Verletzung oder Schaden verursachen.
PRECAUCIÓN: Non lanci in direzione della gente, degli animali, o delle pareti; Potreste causare la lesione o il danno.
CUIDADO: Não lanc no sentido dos povos, dos animais, ou das paredes; Você poderia causar ferimento ou dano.
VOORZICHTIGHEID: Lanceer niet in de richting van mensen, dieren, of muren; U kon verwonding of schade veroorzaken.
WARNING: Sikta inte mot människor, djur eller väggar. Risk för skada eller överkan.
FORSIKTIG: Ikke skyt mot mennesker, dyr eller vegger. Det kan forårsake skade.
VAROITUS: Älä ammu kohti ihmisiä, eläimiä tai seinäiä tai vahinkoa.
ADVARSEL: Skyd ikke i retning af mennesker, dyr samt vægge! Du kan forårsage skader!
ADVÖRUN: Skjöttið ekki í átt að fólki, dýrum eða veggjum; Þú getur valdið slysum.

©2012 K'NEX Limited Partnership Group, P.O. Box 700, Hatfield, PA 19440-0700; 1-800-KID-KNEX (USA/États-Unis/EE.UU./Canada); email@knex.com; www.knex.com. K'NEX is a registered trademark of K'NEX Limited Partnership Group. Customer outside the USA/Canada contact your local distributor at www.knex.com/distributors. (FR) K'NEX est une marque déposée de K'NEX Limited Partnership Group. Le Service clients hors États-Unis/Canada, s'il vous plaît contacter le distributeur local. L'information de distributeur peut être trouvée à www.knex.com/distributors. (ES) K'NEX es una marca registrada de K'NEX Limited Partnership Group. El cliente que no vive en EE.UU./Canada se pone en contacto con el distribuidor local. Encuentre la información para el distribuidor local en www.knex.com/distributors. (AU) (BE) (CL) (MX) (NZ) www.knex.com/distributors (UK) TOMY Caroline, PO Box 20, Totton, Hants, SO40 3YF; Tel 023 8066 2600 (FR) ALLO TOMY SAV, Parc d'affaires international, 74166 ARCHAMPS; Tél 0 820 013 013 (UK) (FR) (DE) (IT) (PT) (NL) (SE) (NO) (FI) (DK) (IS) www.tomy.eu

(EN) Product & colors may vary.
 (FR) Produits et couleurs peuvent varier.
 (ES) El producto y los colores pueden variar.
 (DE) Produkte und Farben können variieren.
 (IT) Prodotti e colori possono differire.
 (PT) O produto e as cores podem variar.
 (NL) Product en kleuren kunnen variëren.
 (SE) Produkter och färger kan variera.
 (NO) Produkter og farger kan variere.
 (FI) Tuotteet ja värit saattavat vaihdella.
 (DK) Produkter og farver kan variere.
 (IS) Hlutir og litir geta verið breytilegir.

! Pizza para Lanzar!
 Zusammendrücken zum schiessen!
 Pizzicare per lanciare!
 Beliscar para Lançar!
 Knijpen om te Starten!
 Nyp för att avfyra!
 Trykk for å starte!
 Laukaise nipistämällä!
 Træk ved affyring!
 Spennid teygjuna til að skjóta!

Identifies Genuine K'NEX Bricks.
 Identifie que ce sont d'authentiques briques K'NEX.
 Identifica los ladrillos genuinos de K'NEX.
 Identifiziert echte K'NEX-Bausteine.
 Edentifica i veri blocchi K'NEX.
 Identifica que são cubos genuínos da K'NEX.
 Identificeert K'NEX bakstenen voor.
 Innehåller K'NEX originalklossar.
 Identifiserer ekte K'NEX-brikker.
 Aidot K'NEX pallikat.
 Garanteret ægte K'NEX dele.
 Hægt að nota með öðrum K'NEX kubbum.

KNEX.COM

Bonus instructions at www.knex.com/angry-birds
 Plans supplémentaires à www.knex.com/angry-birds
 Instrucciones de la prima en www.knex.com/angry-birds
 Zusätzliche Bauanleitungen bei www.knex.com/angry-birds
 Bonus istruzioni a www.knex.com/angry-birds
 Instruções do bônus em www.knex.com/angry-birds
 De instructies van de bonus bij www.knex.com/angry-birds
 Bonus instruktioner på www.knex.com/angry-birds
 Bonus instruktionene på www.knex.com/angry-birds
 Bonus ohjeita www.knex.com/angry-birds
 Bonus anvisninger på www.knex.com/angry-birds
 Bónus leiðbeiningar á www.knex.com/angry-birds

† Recoger a todos!
 Sammeln sie alle!
 Raccogliere tutti!
 Recolha-os todos!
 Verzamel ze allemaal!
 Samla alla!
 Kerää koko setti!
 Du kan samle på flere dele!
 Safnaðu þeim öllum!

* Sold separately
 Vendus séparément
 Se venden por separado
 Separat erhältlich
 Venduti separatamente
 Vendidos separadamente
 Afzonderlijk verkocht
 Säljs separat
 Selges separat
 Myydään erikseen
 Sælges separat
 Selt sér

COLLECT THEM ALL! RECUEILLES LES TOUS !



ROVIO
 ANGRY BIRDS IS A TRADEMARK OF ROVIO ENTERTAINMENT LTD. ALL RIGHTS RESERVED. COPYRIGHT ©2009-2012 ROVIO ENTERTAINMENT LTD. ALL RIGHTS RESERVED.
WWW.ANGRYBIRDS.COM
 ANGRY BIRDS EST UNE MARQUE DÉPOSÉE DE ROVIO ENTERTAINMENT LTD. TODOS LOS DERECHOS RESERVADOS. © 2009-2012 ROVIO ENTERTAINMENT LTD. TODOS LOS DERECHOS RESERVADOS.
 ANGRY BIRDS ES UNA MARCA DE ROVIO ENTERTAINMENT LTD. TODOS LOS DERECHOS RESERVADOS. © 2009-2012 ROVIO ENTERTAINMENT LTD. TODOS LOS DERECHOS RESERVADOS.
 412636.11-V3-08/12
 CE Tomy UK Ltd, Totton, Hants SO40 3SA, England

ANGRY BIRDS™

ICE BIRD BREAKDOWN LE GLACE OISEAU DÉMOLITION BUILDING SET JEU DE CONSTRUCTION



WARNING :
 CHOKING HAZARD – Toy contains a small ball and small parts. Not for children under 3 years.

ATTENTION !
 RISQUE D'ÉTOUFFEMENT – Jouet contient une petite boule et pièces de petite taille. Ne convient pas aux enfants de moins de 3 ans.

7+
K'NEX



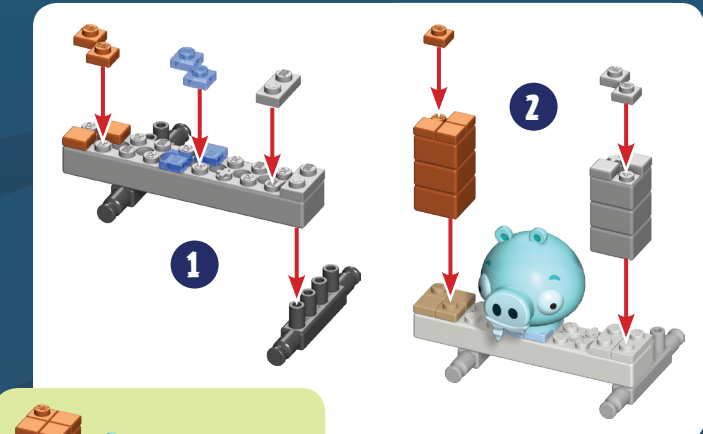

1-2

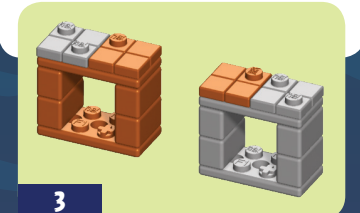
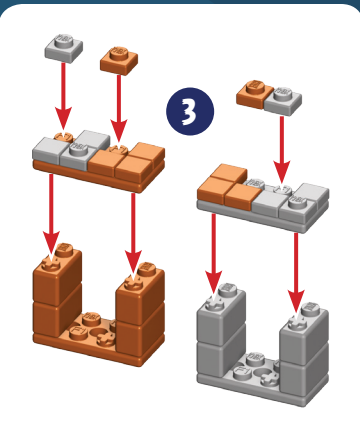

3

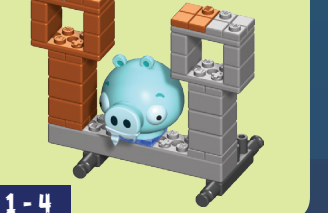
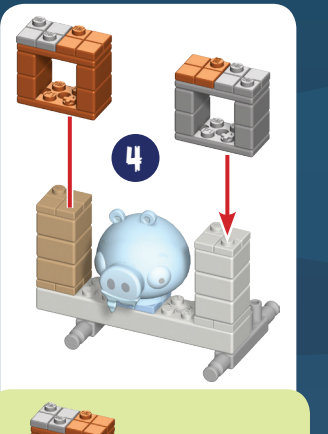

1-4



11

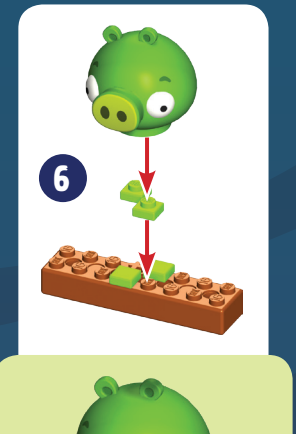

6

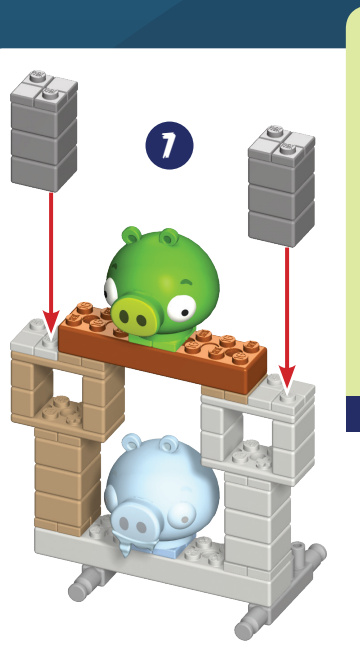

1-7

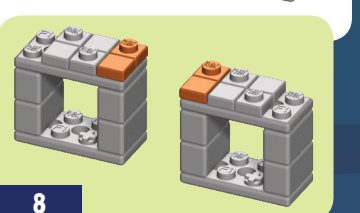
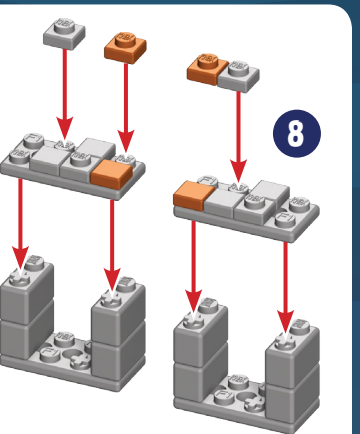

8

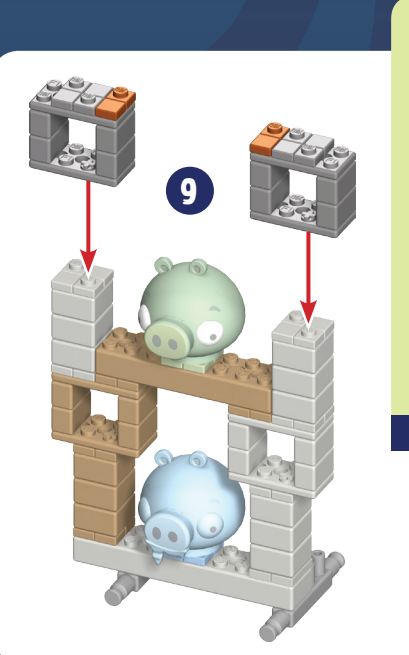

1-9

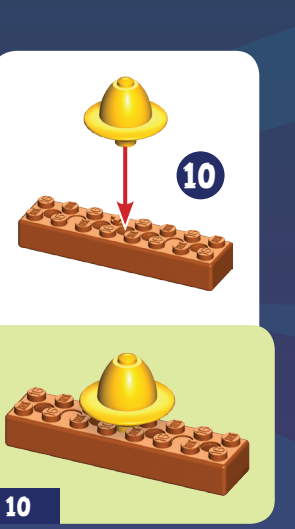

10



11

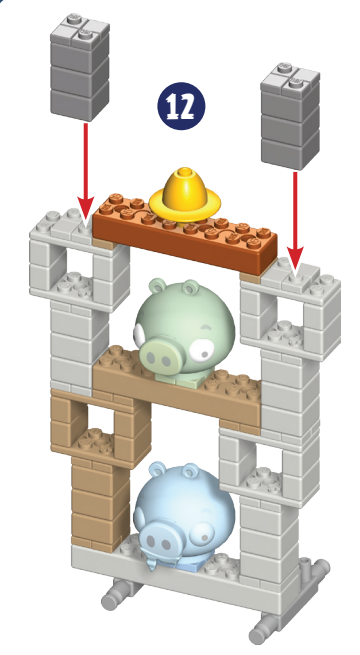

1-12

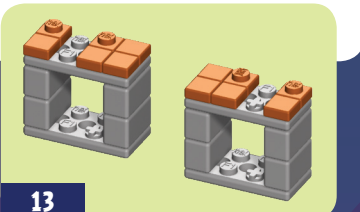
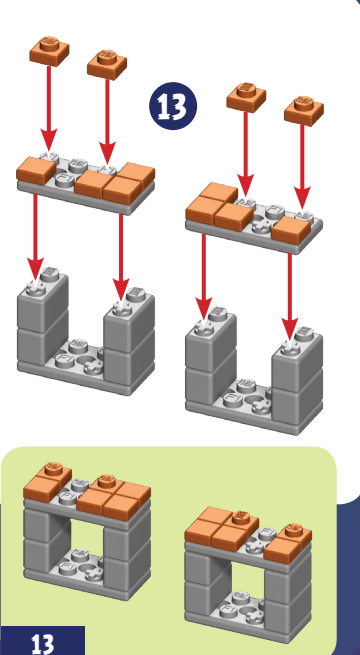

13

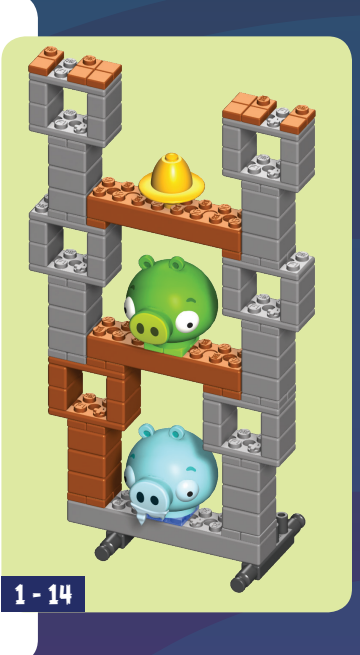
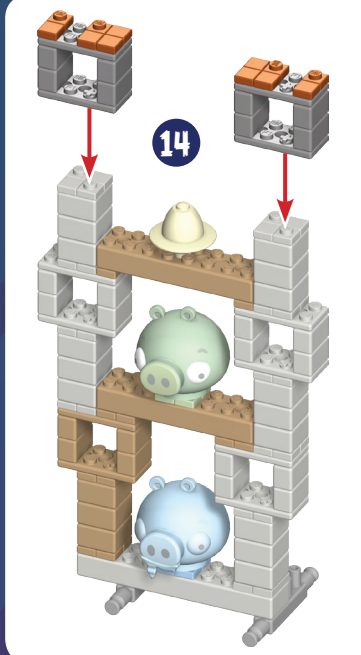

1-14



15

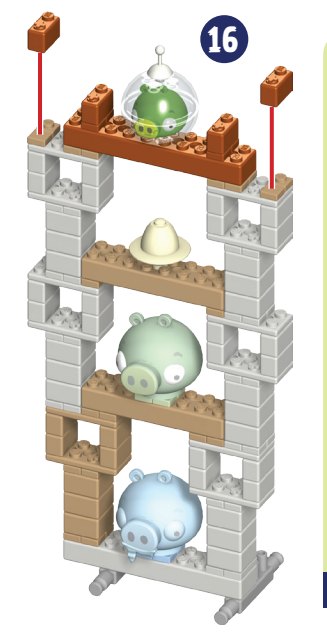

1-16

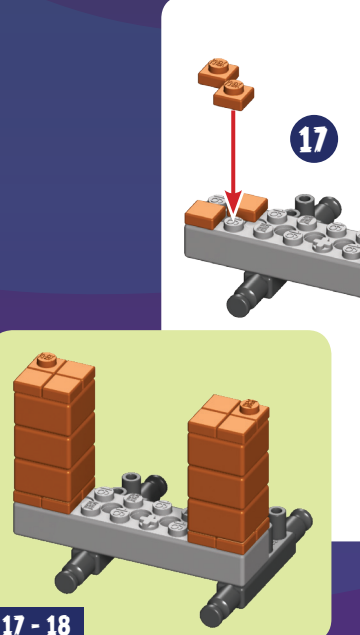

17-18

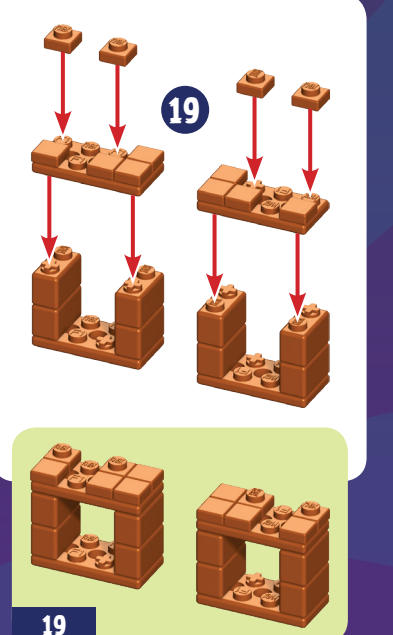
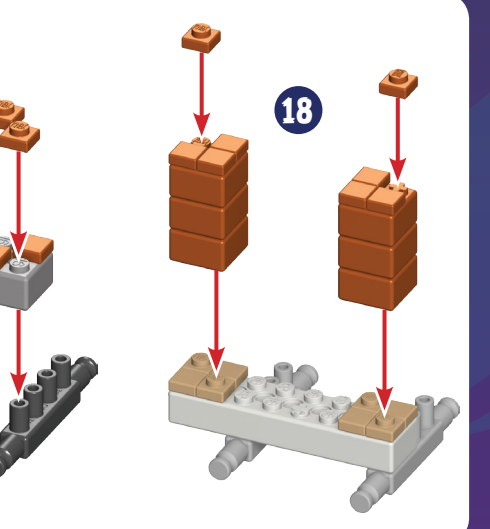

19

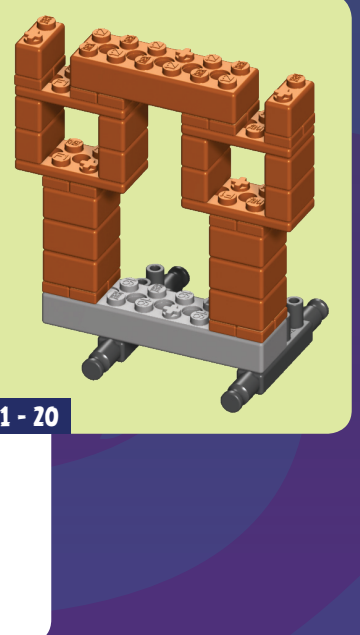
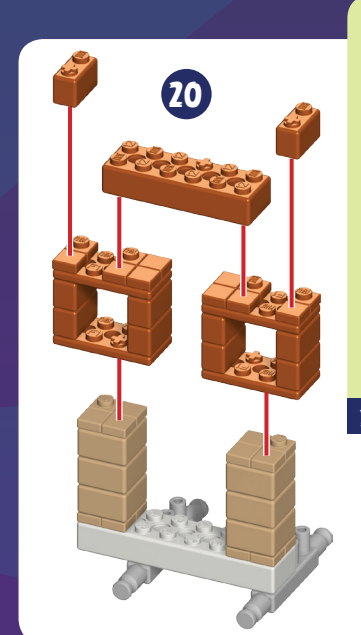

1-20