

©2012 K'NEX Limited Partnership Group, P.O. Box 700, Hatfield, PA 19440-0700; 1-800-KID-KNEX (USA/Canada/États-Unis/EE.UU.); email@knex.com; www.knex.com. K'NEX is a registered trademark of K'NEX Limited Partnership Group. Customer outside the USA/Canada contact your local distributor at www.knex.com/distributors. (FR) K'NEX est une marque déposée de K'NEX Limited Partnership Group. Le Service clients hors États-Unis/Canada, s'il vous plaît contacter le distributeur local. L'information de distributeur peut être trouvée à www.knex.com/distributors. (ES) K'NEX es una marca registrada de K'NEX Limited Partnership Group. El cliente que no vive en EE.UU./Canadá se pone en contacto con el distribuidor local. Encuentre la información para el distribuidor local en www.knex.com/distributors. (AU) (BE) (CL) (DE) (MX) (NL) (NZ) www.knex.com/distributors (UK) TOMY Careline, P.O. Box 20, Totton, Hants, SO40 3YF; Tel 023 8066 2600 (FR) ALLO TOMY SAV, Parc d'affaires international, 74166 ARCHAMPS; Tél 0 820 013 013 (DE) (FR) (NL) (UK) www.tomy.eu

(EN) Product & colors may vary.  
 (FR) Produits et couleurs peuvent varier.  
 (ES) El producto y los colores pueden variar.  
 (DE) Produkte und Farben können variieren.  
 (IT) Il prodotto e i colori possono differire.  
 (PT) O produto e as cores podem variar.  
 (NL) Product en kleuren kunnen variëren.  
 (SE) Produkter och färger kan variera.  
 (NO) Produkter og farger kan variere.  
 (DK) Tøufætt og værdi saattavt valdhælla.  
 (FI) Produkter og farver kan variere.  
 (IS) Hlutir og litir geta verið breytilegir.

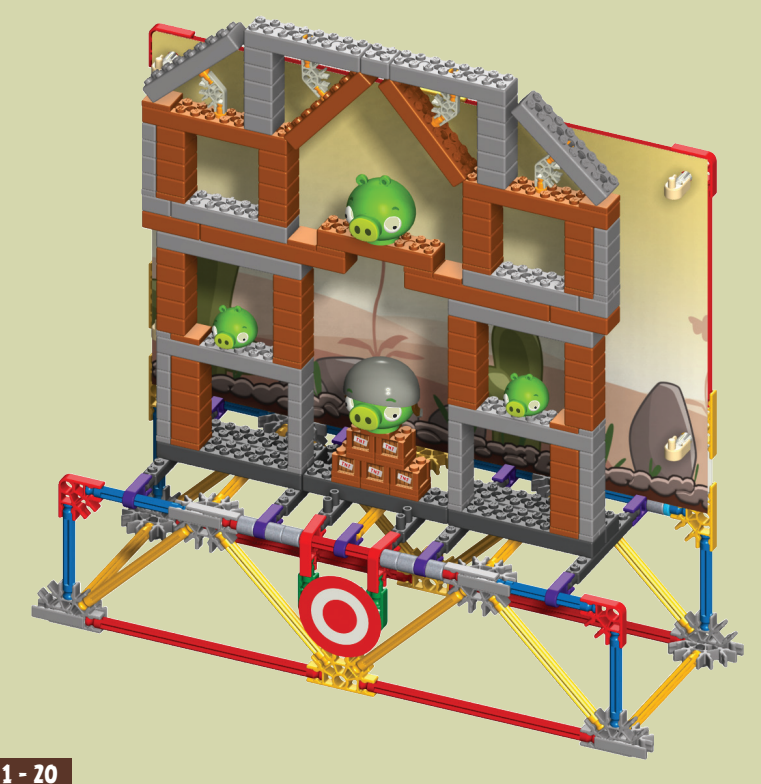
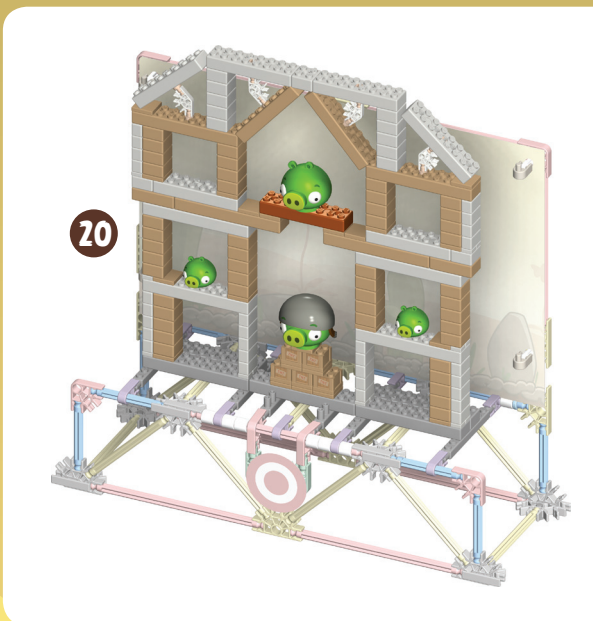
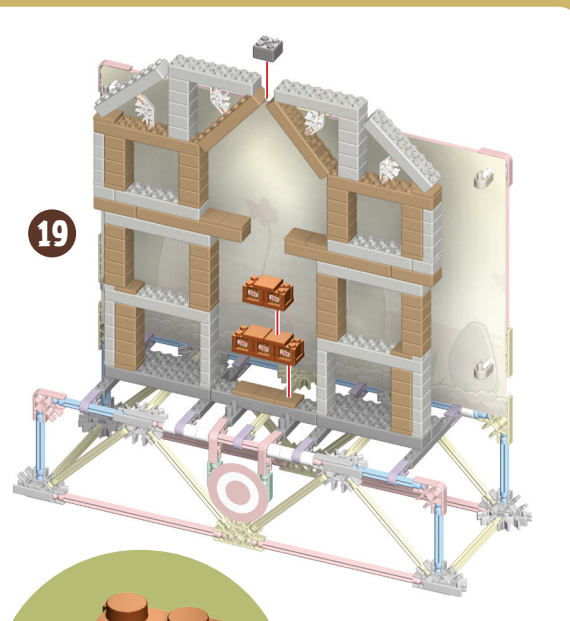

Bonus instructions at [www.knex.com/angry-birds](http://www.knex.com/angry-birds)  
 Plans supplémentaires à [www.knex.com/angry-birds](http://www.knex.com/angry-birds)  
 Instrucciones de la prima en [www.knex.com/angry-birds](http://www.knex.com/angry-birds)  
 Zusätzliche Bauanleitungen bei [www.knex.com/angry-birds](http://www.knex.com/angry-birds)  
 Bonus Istruzioni a [www.knex.com/angry-birds](http://www.knex.com/angry-birds)  
 Instruções do bônus em [www.knex.com/angry-birds](http://www.knex.com/angry-birds)

De instructies van de bonus bij [www.knex.com/angry-birds](http://www.knex.com/angry-birds)  
 Bonus instruktioner på [www.knex.com/angry-birds](http://www.knex.com/angry-birds)  
 Bonus instruksjonene på [www.knex.com/angry-birds](http://www.knex.com/angry-birds)  
 Bonus ohjeita [www.knex.com/angry-birds](http://www.knex.com/angry-birds)  
 Bonus anvisninger på [www.knex.com/angry-birds](http://www.knex.com/angry-birds)  
 Bónus leiðbeiningar á [www.knex.com/angry-birds](http://www.knex.com/angry-birds)

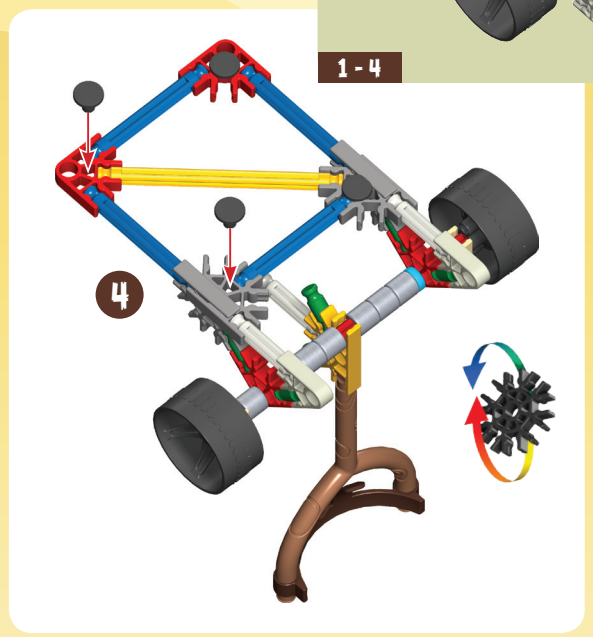
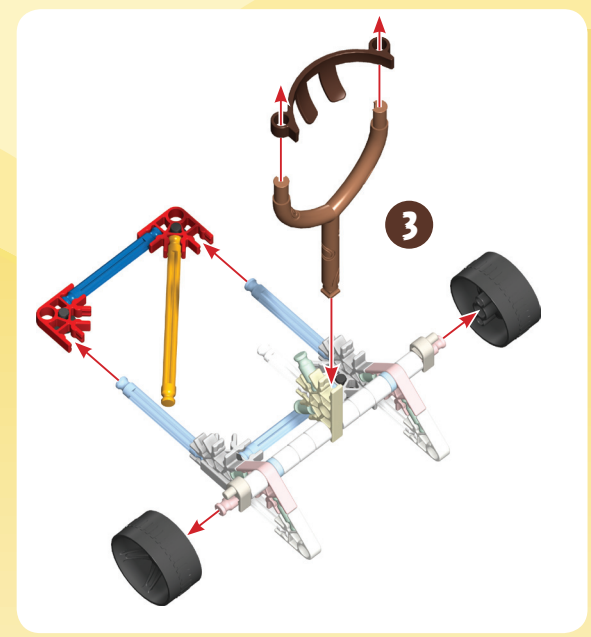
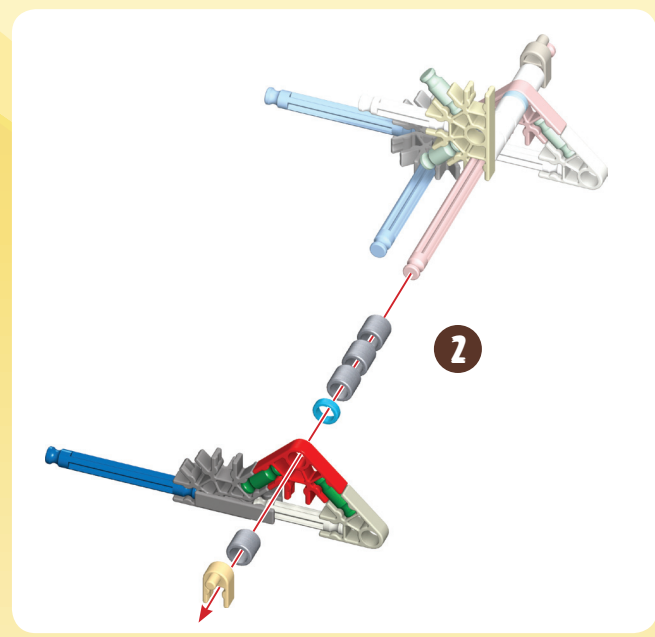
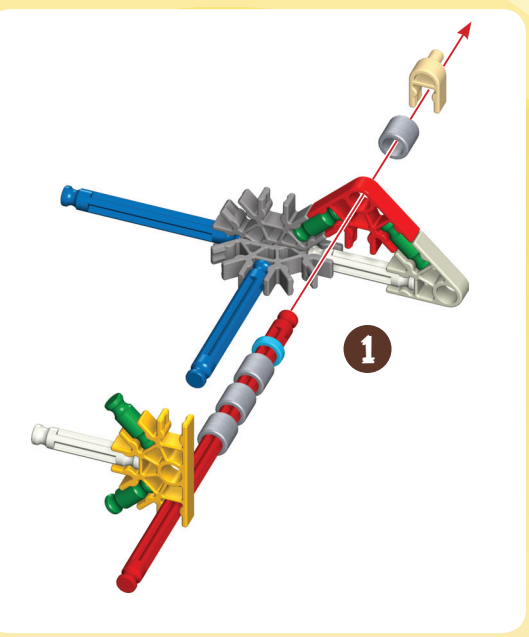
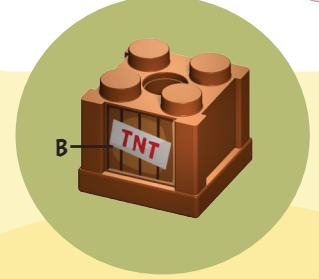
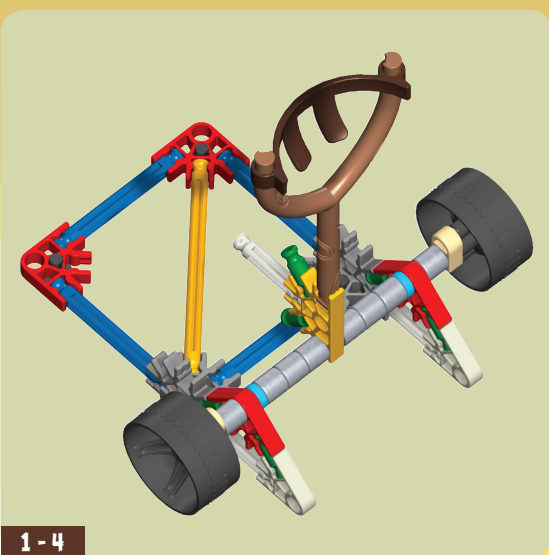

**WARNING: CHOKING HAZARD** – Toy contains a small ball and small parts. Not for children under 3 years.  
**ATTENTION ! RISQUE D'ÉTOUFFEMENT** – Jouet contient une petite boule et pièces de petite taille. Ne convient pas aux enfants de moins de 3 ans.  
**ADVERTENCIA: PELIGRO DE ASFIXIA** – Juguete contiene una pequeña bola y piezas pequeñas. No recomendado para niños menores de 3 años.  
**WARNUNG: ERSTICKUNGSGEFAHR** – Spielzeug enthält einen kleinen Ball und Kleinteile. Nicht für Kinder unter 3 Jahren.  
**AVVISO: PERICOLO DI SOFFOCARE** – Giocattolo a una piccola pallina e pezzi piccoli. Non adatto per bambini sotto 3 anni.  
**AVISO: PERIGO DE SUFOCAÇÃO** – Toy contém uma pequena bola e peças pequenas. Não indicado para crianças menores de 3 anos.  
**WAARSCHUWING: VERSTIKKINGSGEVAAR** – Toy bevat een kleine bal en kleine onderdelen. Niet voor kinderen onder de 3 jaar.  
**WARNING: KVAÐNINGSRISK** – Innehåller liten boll och små delar. Inte för barn under 3 år.  
**ADVARSEL: KVELNINGSFARE** – Leken inneholder en liten ball og små deler. Ikke egnet for barn under 3 år.  
**VAROITUS: TUKEHTUMISVAARA** – Lelu sisältää pienen pallon ja pieniä osia. Ei sovelle alle 3-vuotiaalle lapsille.  
**ADVARSEL: INDEHOLDER SMÅ DELE** – Dette legetøj inkluderer en lille bold og andre smådele. Ikke egnet til børn under 3 år.  
**ADVÖRUN: KÖFNUNARHÆTTA** – Leikfangið inniheldur lítinn bolta og litla hluti. Ekki fyrir börn undir 3ja ára.

**CAUTION:** Do not launch in the direction of people, animals, or walls; You could cause injury or damage.  
**PRECAUCIÓN:** No lance en dirección de gente, de animales, o de paredes; Usted podría estropear lesión o.  
**ATTENTION :** Ne lancez pas dans la direction des personnes, des animaux, ou des murs ; Vous pourriez endommager des dommages ou.  
**VORSICHT:** Starten Sie nicht in Richtung der Leute, der Tiere oder der Wände; Sie könnten Verletzung oder Schaden verursachen.  
**AVVERTENZA:** Non lanci in direzione della gente, degli animali, o delle pareti; Potreste causare la lesione o il danno.  
**VOORZICHTIGHEID:** Lancer niet in de richting van mensen, dieren, of muren; U kan verwonding of schade veroorzaken.  
**VARNING:** Sikta inte mot människor, djur eller väggar. Risk för skada eller överkan.  
**FORSIKTIG:** Ikke skyt mot mennesker, dyr eller vegger. Det kan forårsake skade.  
**VAROITUS:** Älä ammu kohti ihmisiä, eläimiä tai seinäiä kohti. Voi aiheuttaa vammoja tai vahinkoa.  
**ADVARSEL:** Skyd ikke i retning af mennesker, dyr samt vægge! Du kan forårsage skader!  
**ADVÖRUN:** Skjótúð ekki í átt að fólk, dýrum eða veggjum; Þú getur valdið slysum.

**KNEX**  
 Genuine K'NEX Bricks

- Identifies Genuine K'NEX Bricks.
- Identifie que ce sont d'authentiques briques K'NEX.
- Identifica los ladrillos genuinos de K'NEX.
- Identifiziert echte K'NEX-Bausteine.
- Identifica i veri blocchi K'NEX.
- Identifica que são cubos genuínos da K'NEX.
- Identificeert K'NEX bakstenen voor.
- Innehåller K'NEX originalkubbar.
- Identifiserer ekte K'NEX-brikker.
- Aidat K'NEX palikat.
- Garanteret ægte K'NEX dele.
- Hægt að nota með öðrum K'NEX kubbum

**ROVIO**  
 ANGRY BIRDS IS A TRADEMARK OF ROVIO ENTERTAINMENT LTD. ALL RIGHTS RESERVED. COPYRIGHT ©2009-2012 ROVIO ENTERTAINMENT LTD. ALL RIGHTS RESERVED.  
**WWW.ANGRYBIRDS.COM**  
 ANGRY BIRDS EST UNE MARQUE DÉPOSÉE DE ROVIO ENTERTAINMENT LTD. TOUS DROITS RÉSERVÉS. © 2009-2012 ROVIO ENTERTAINMENT LTD. TOUS DROITS RÉSERVÉS.  
 ANGRY BIRDS ES UNA MARCA DE ROVIO ENTERTAINMENT LTD. TODOS LOS DERECHOS RESERVADOS. © 2009-2012 ROVIO ENTERTAINMENT LTD. TODOS LOS DERECHOS RESERVADOS.

\* Torcer para lanzar. Drehen zum Schließen. Torcere per lanciare. Torcer para lançar. Draaien te starten. Vrid og skjut ívág. Vri for å starte. Väännä ja laukaise. Vrid ved afyring. Teigið til að skjóta.

\*\* Incluye escenarios de el juego. Beinhaltet Szenerie aus dem Spiel. Include scenario dal gioco. Inclui cenário de jogo. Inclusief landschap van spel. Innehåller scener från spelet. Inkluderer scenebilder fra spillet. Sisältää kuvia pelistä. Inkluderer billeder fra spillet. Inniheldur landslag úr leiknum.



**WARNING:** CHOKING HAZARD – Toy contains a small ball and small parts. Not for children under 3 years.  
**ATTENTION !** RISQUE D'ÉTOUFFEMENT – Jouet contient une petite boule et pièces de petite taille. Ne convient pas aux enfants de moins de 3 ans.

**7+** **K'NEX**

