

# F-14 Jet

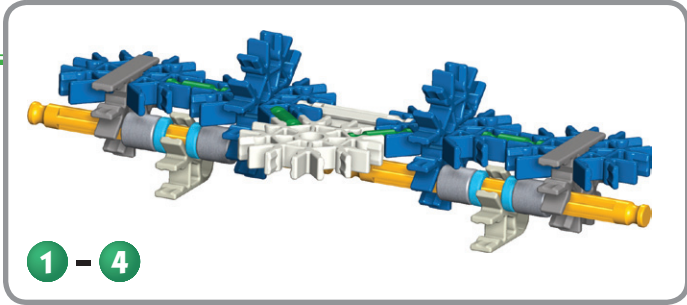

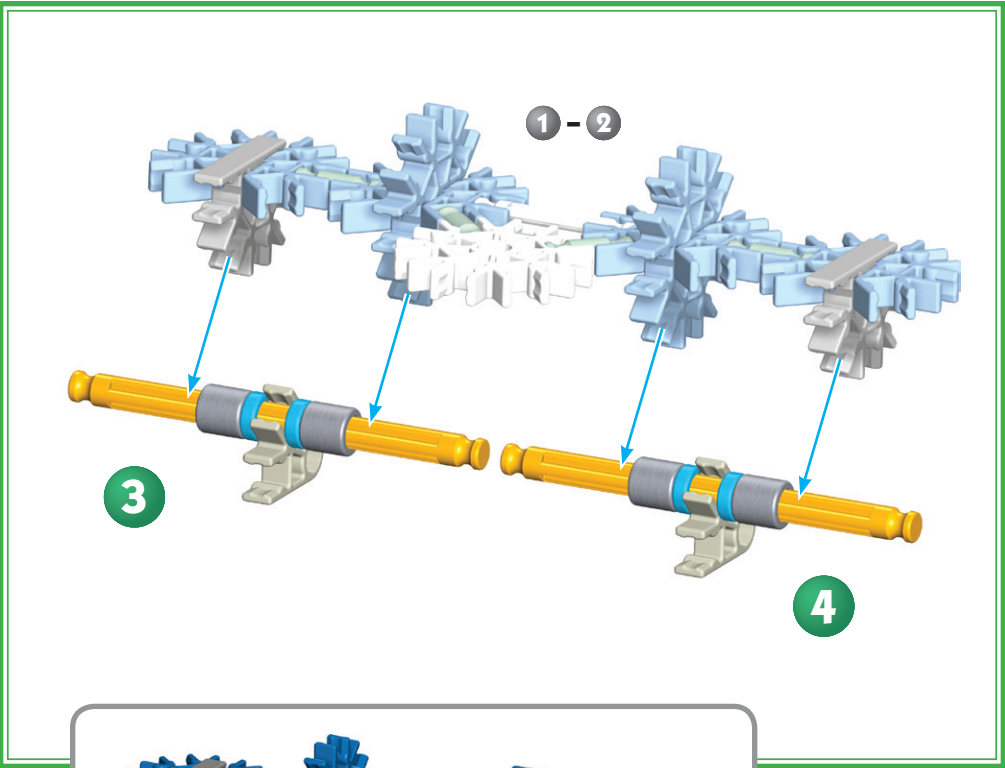

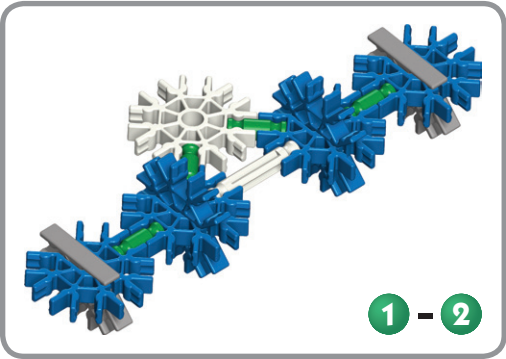

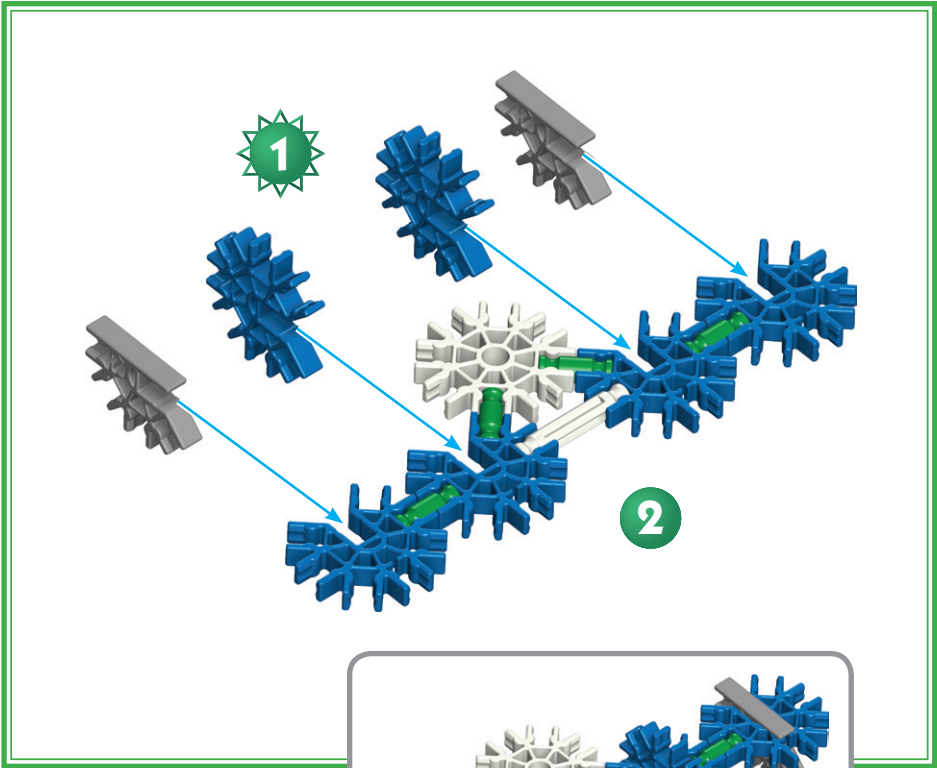
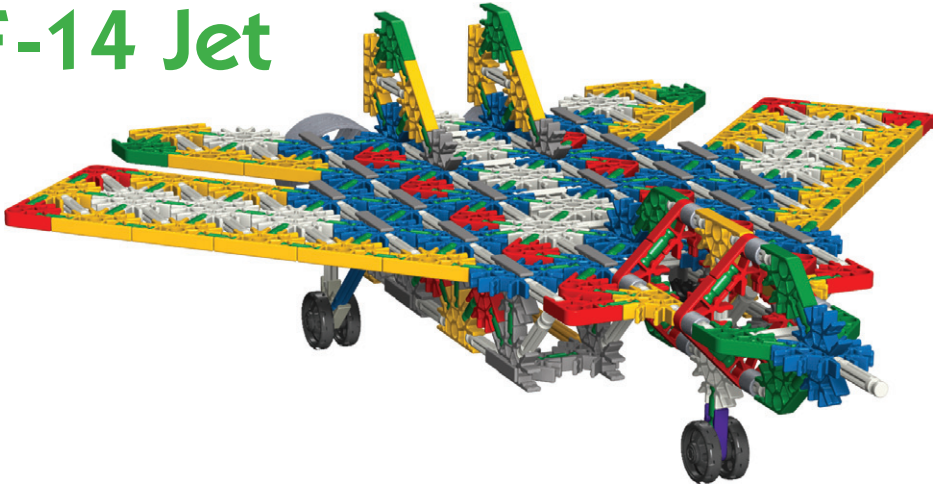
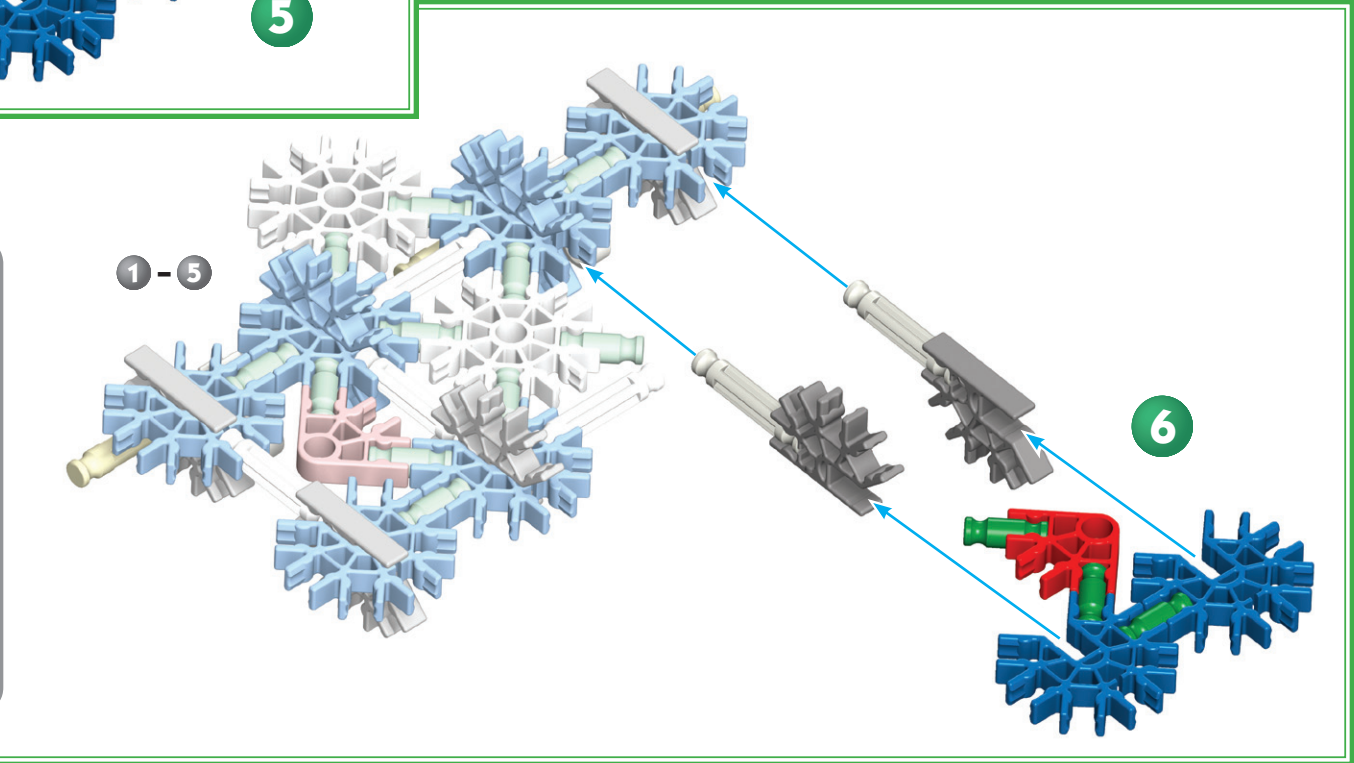
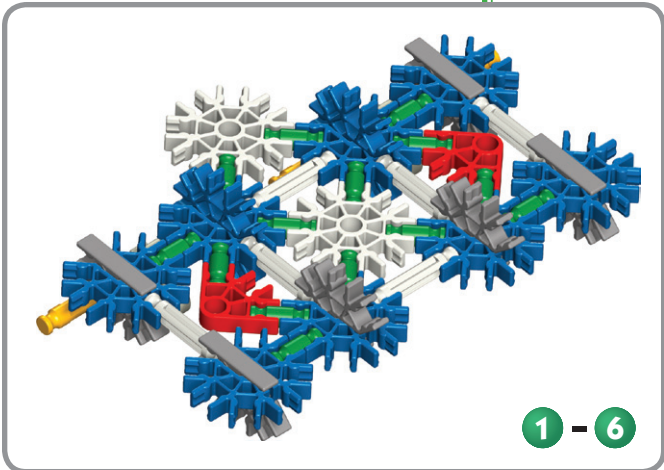
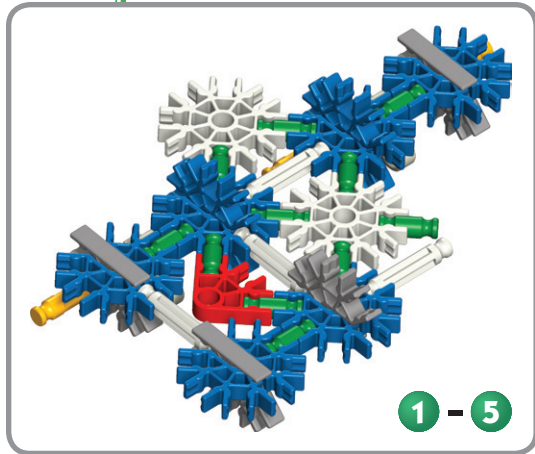
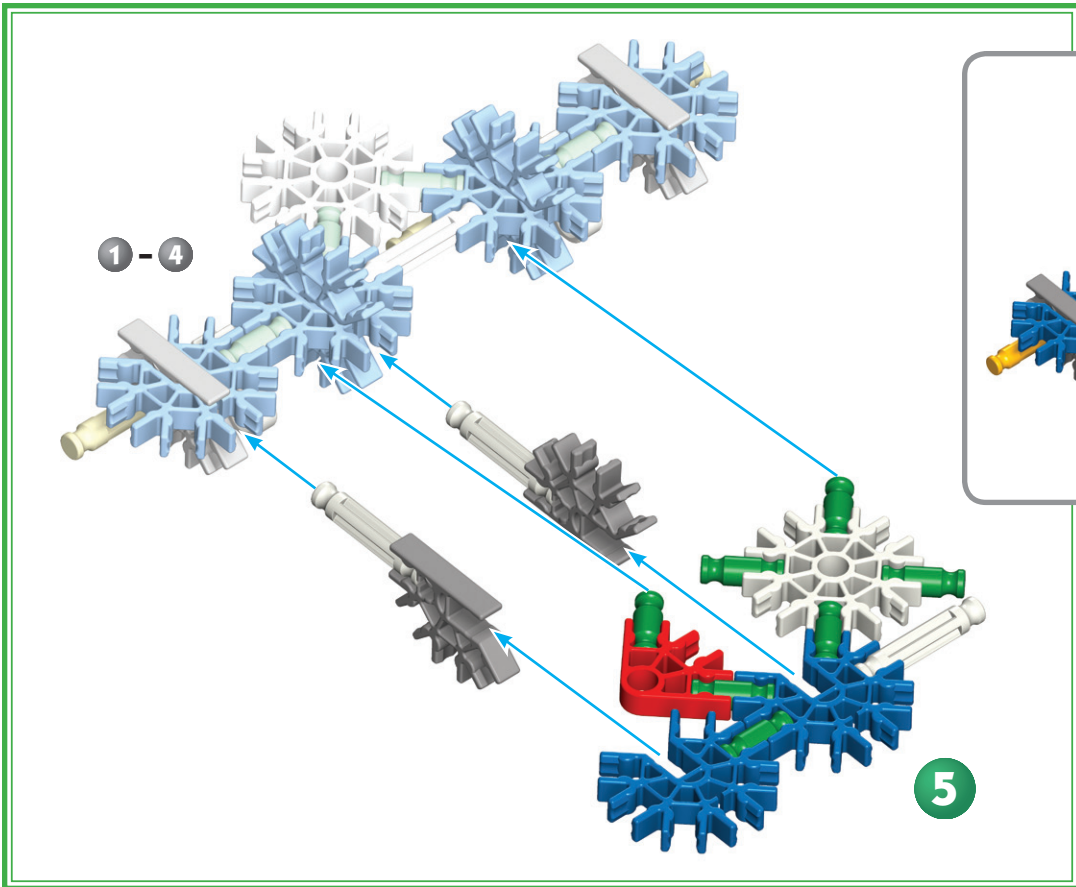
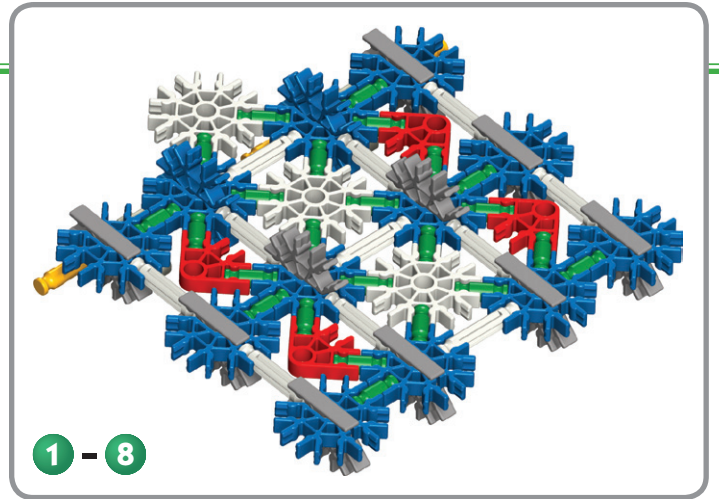
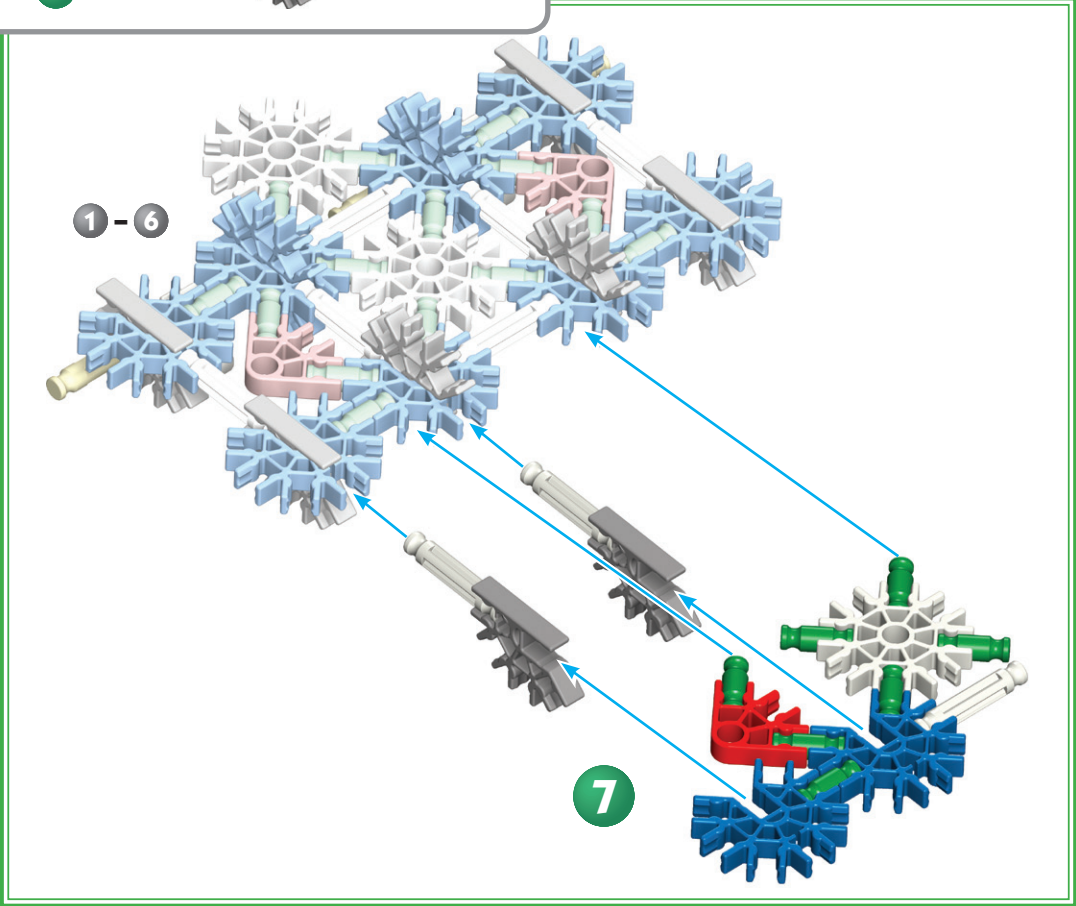
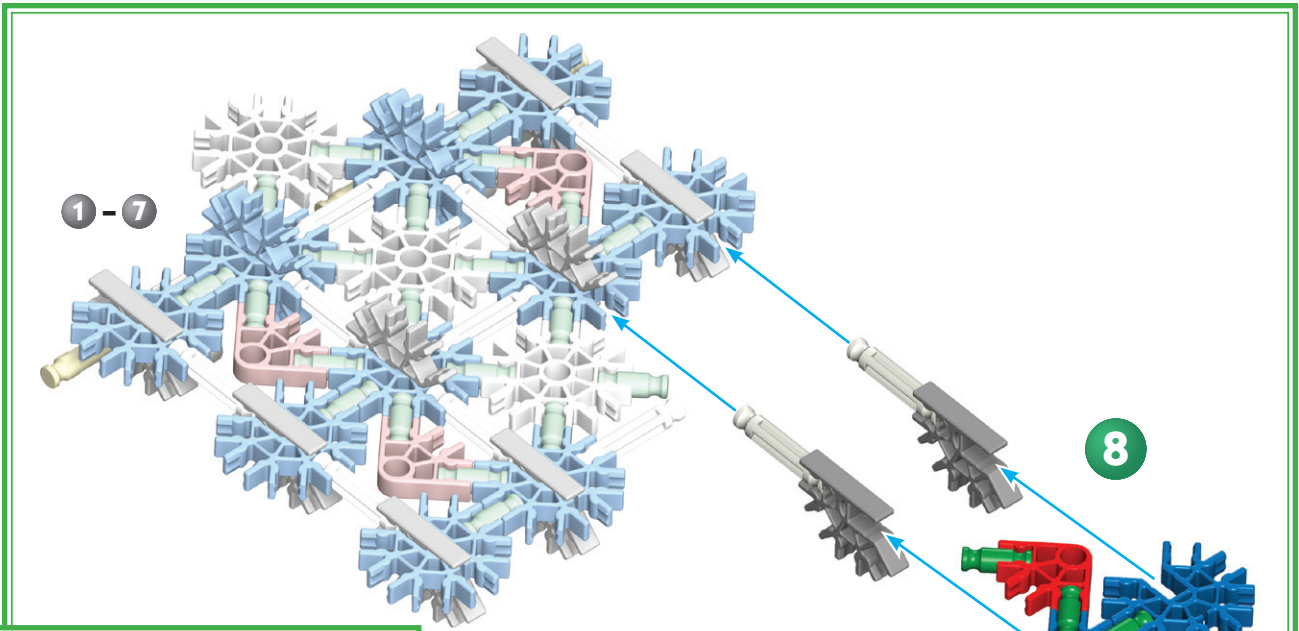
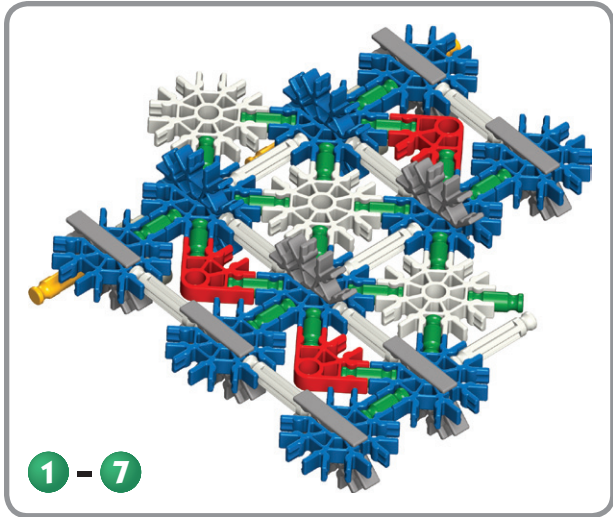
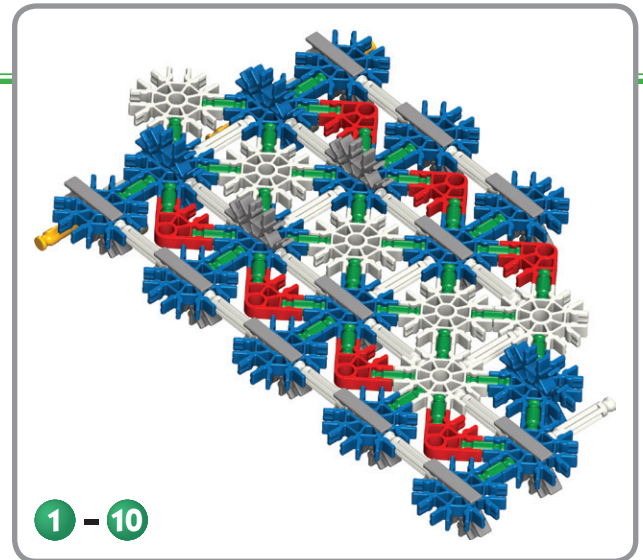
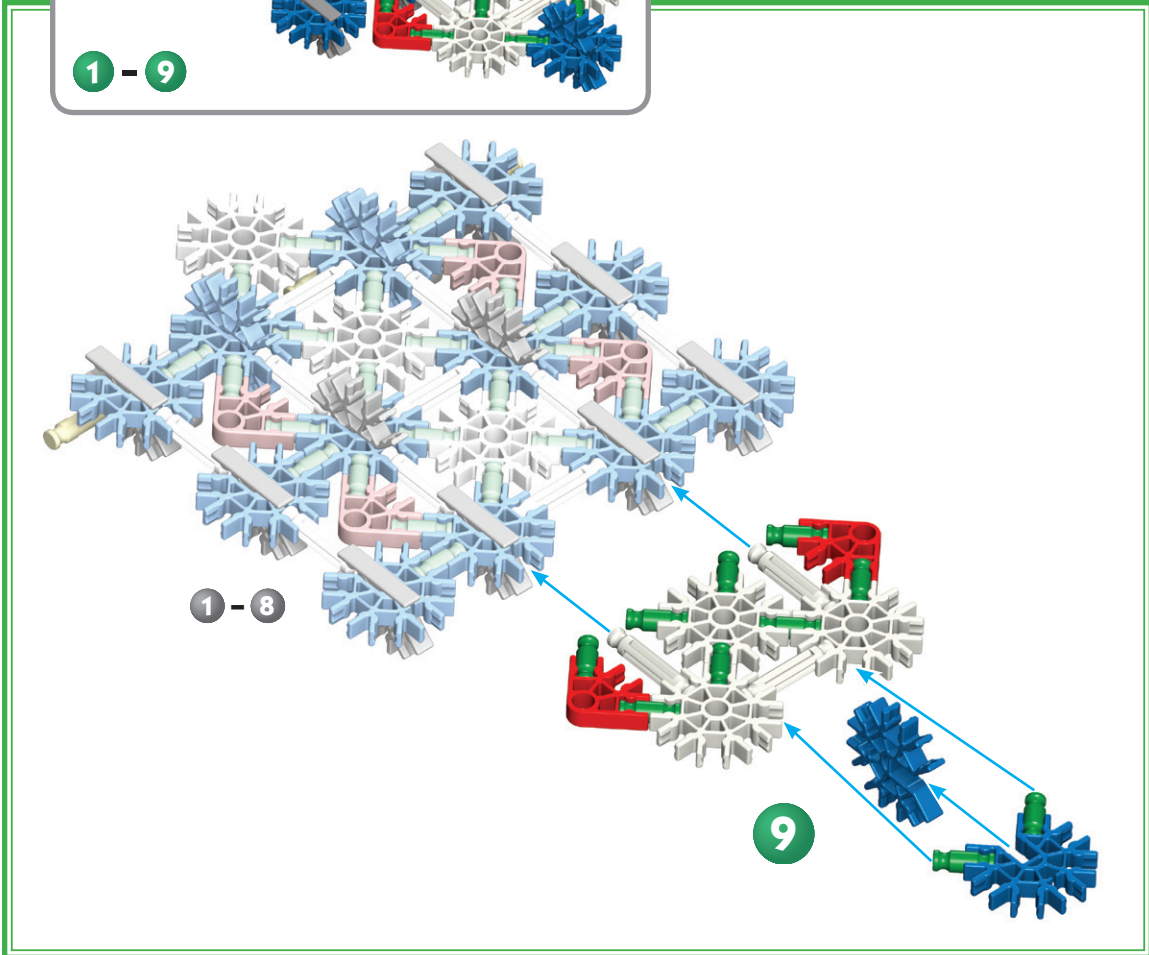
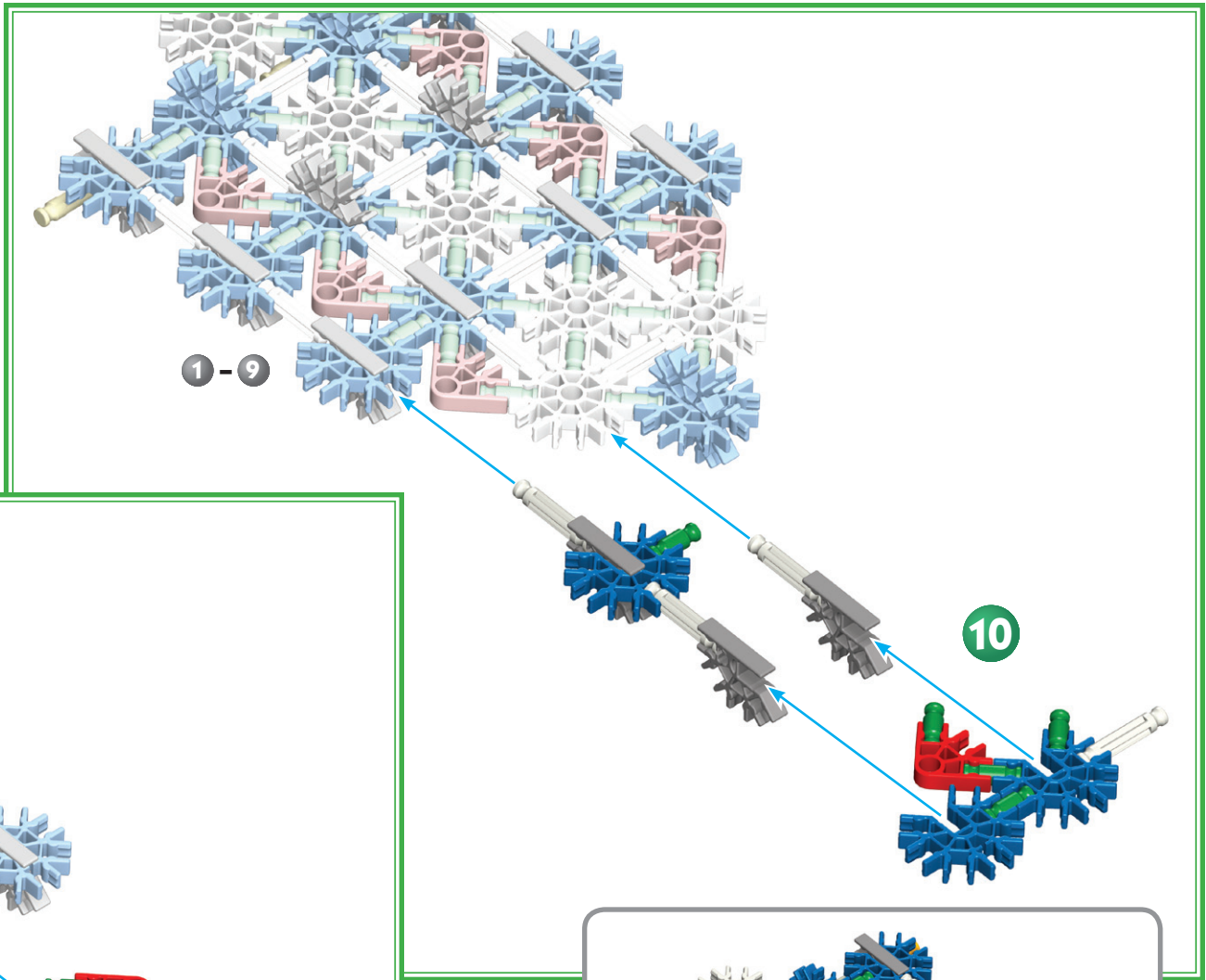
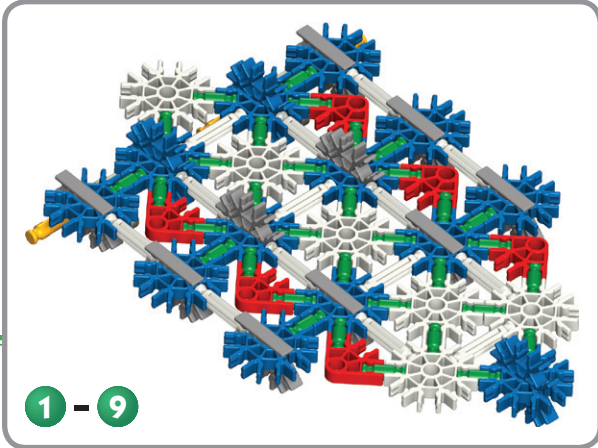

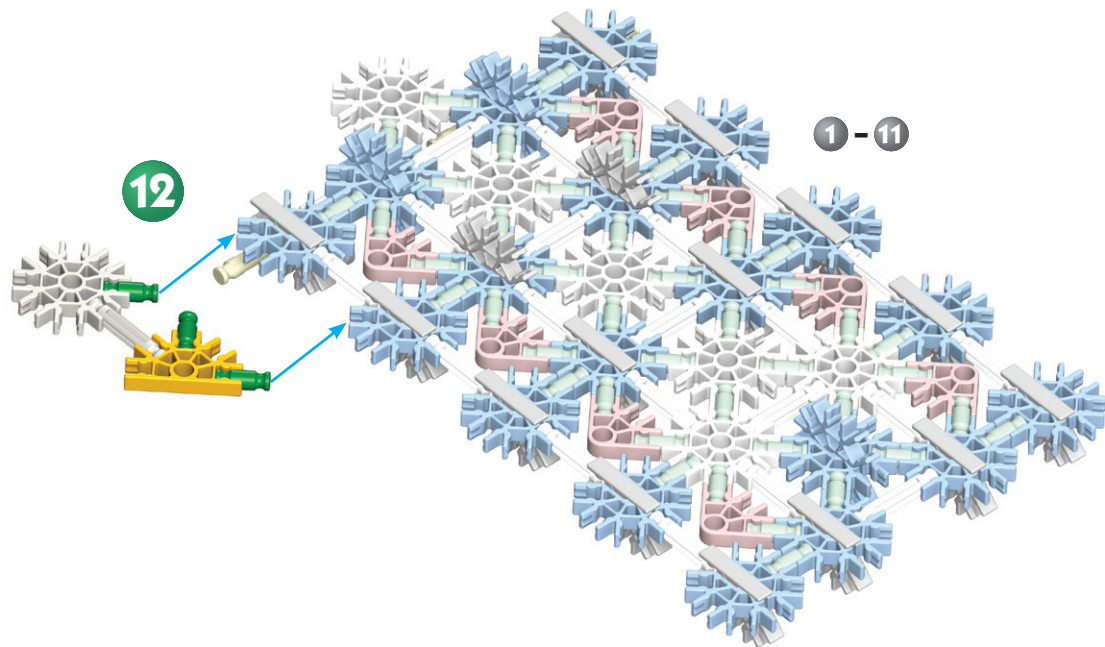
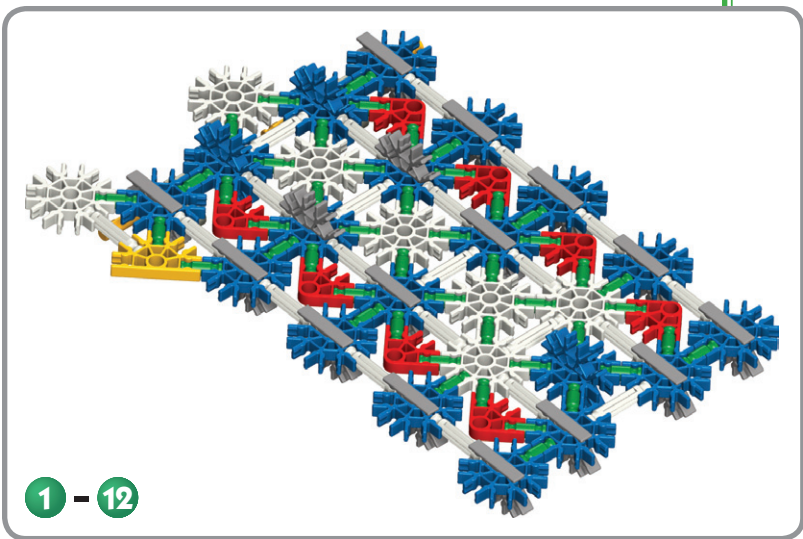
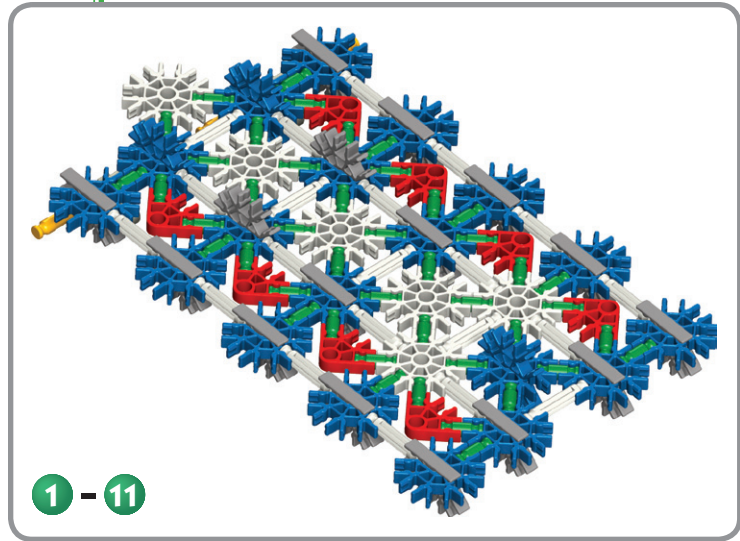
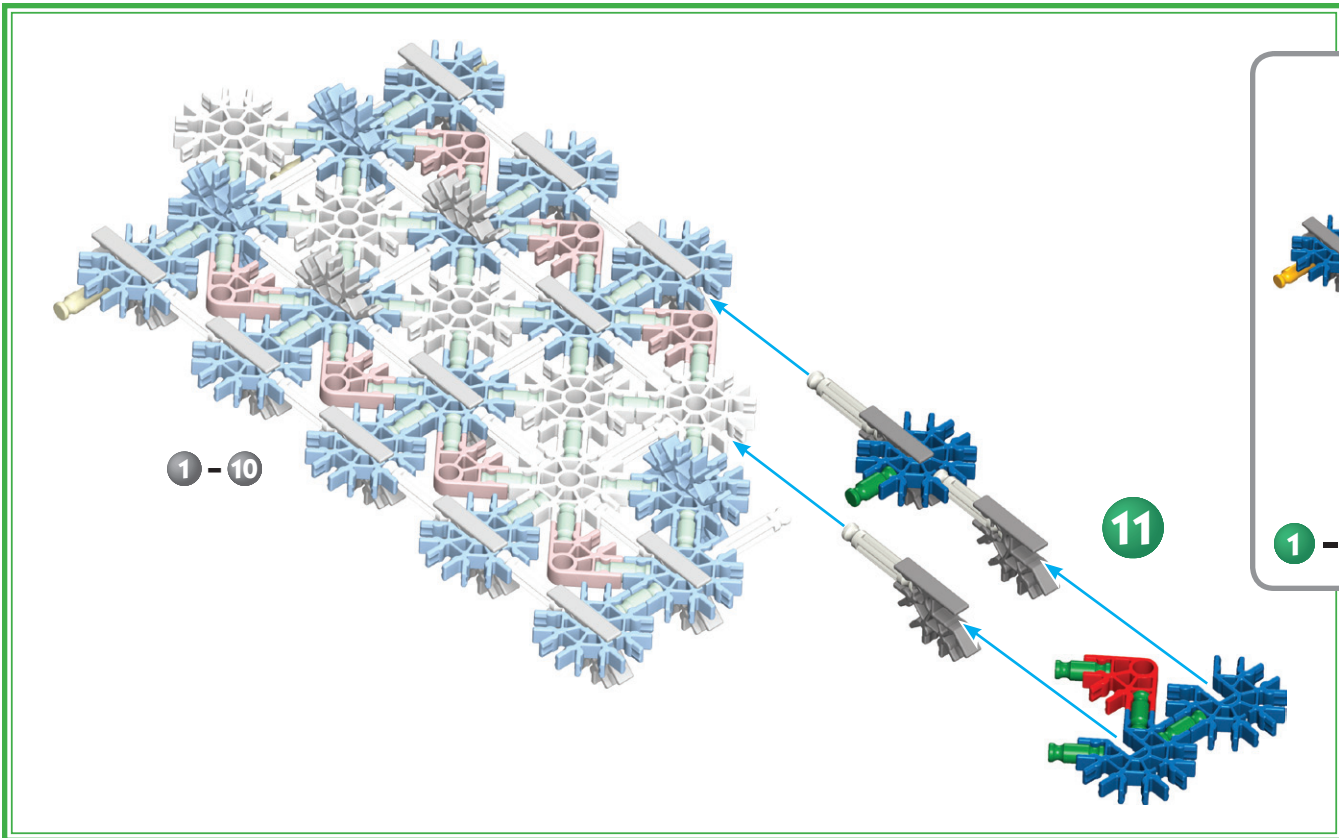

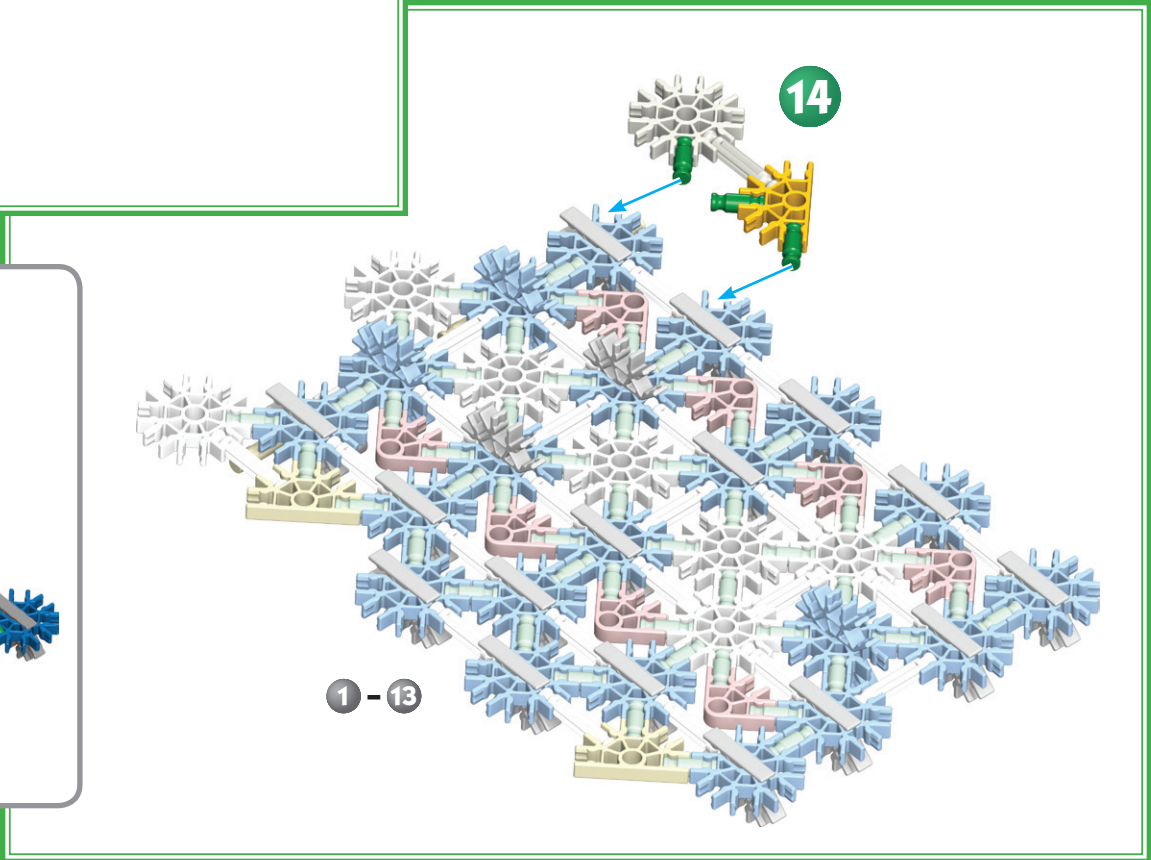
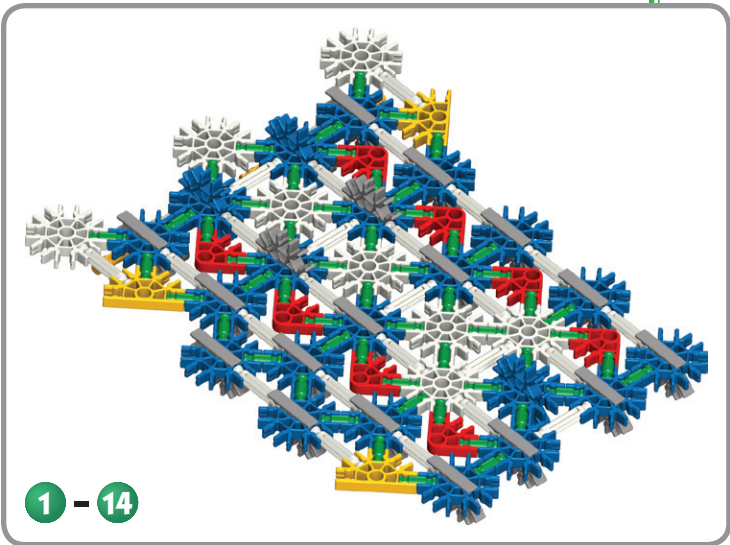
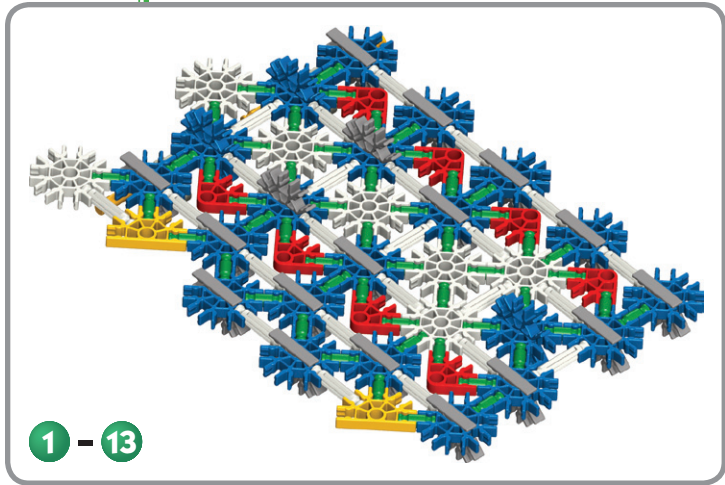
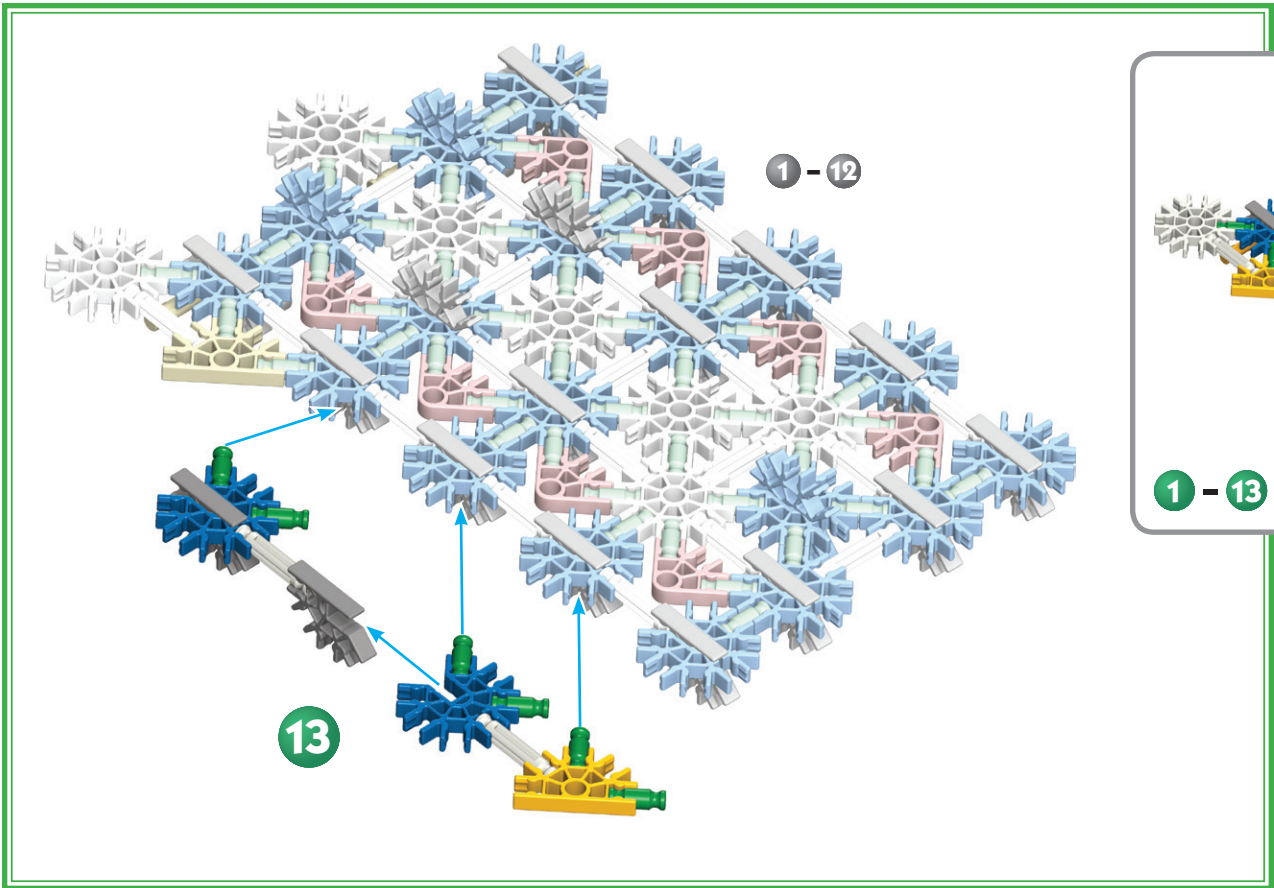

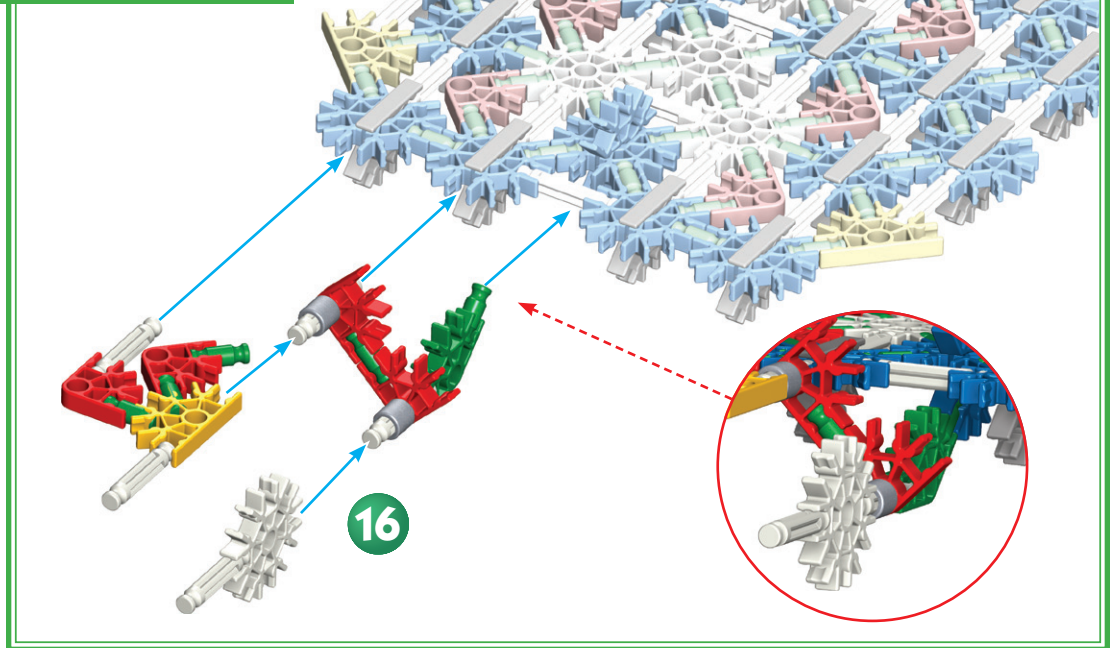
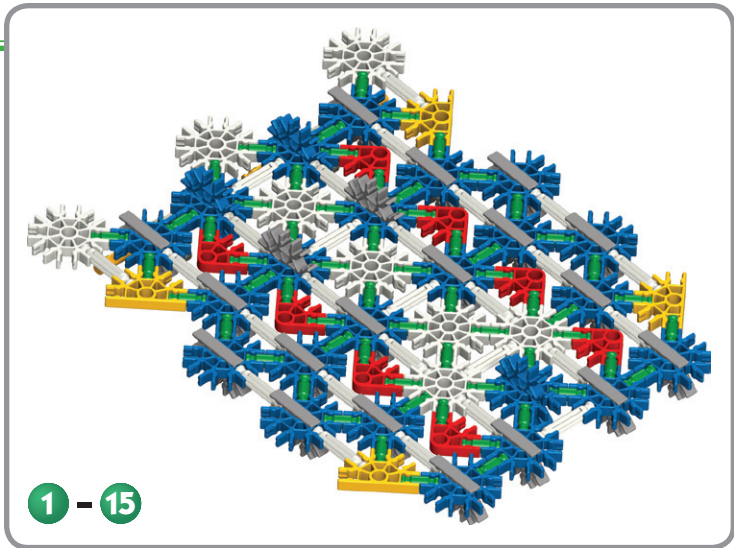
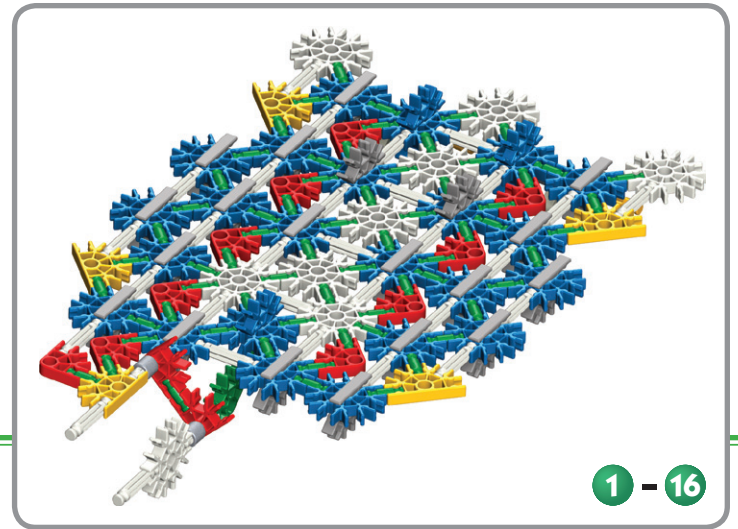
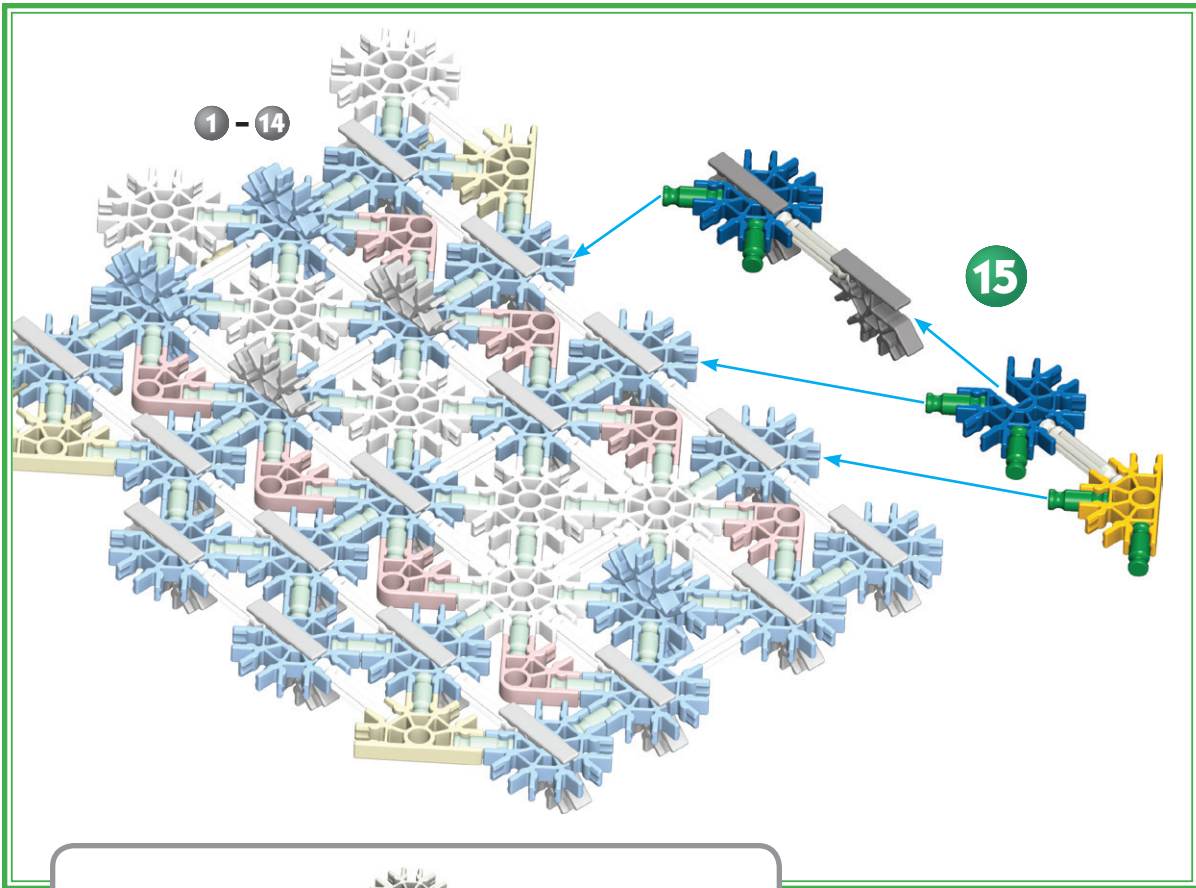

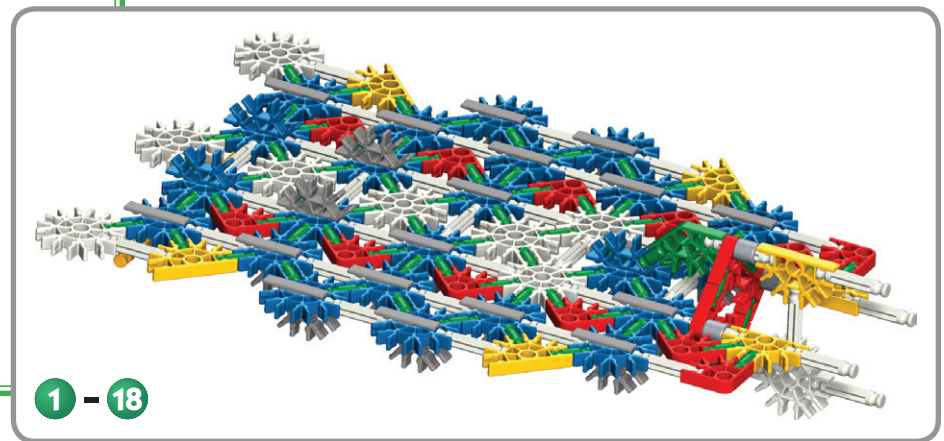
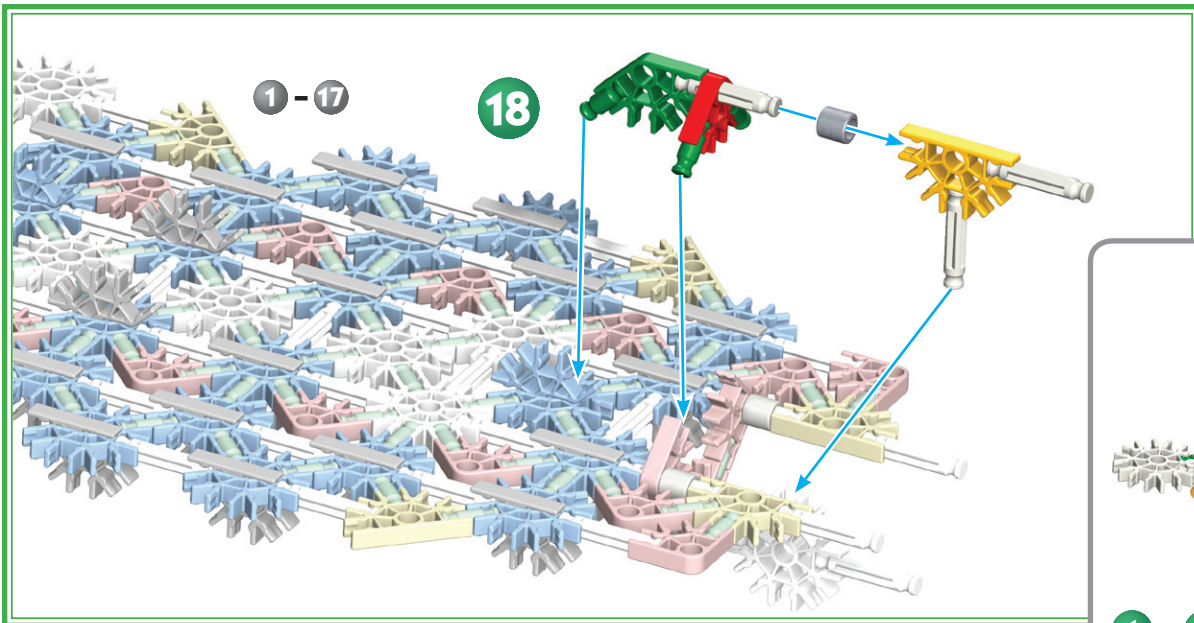
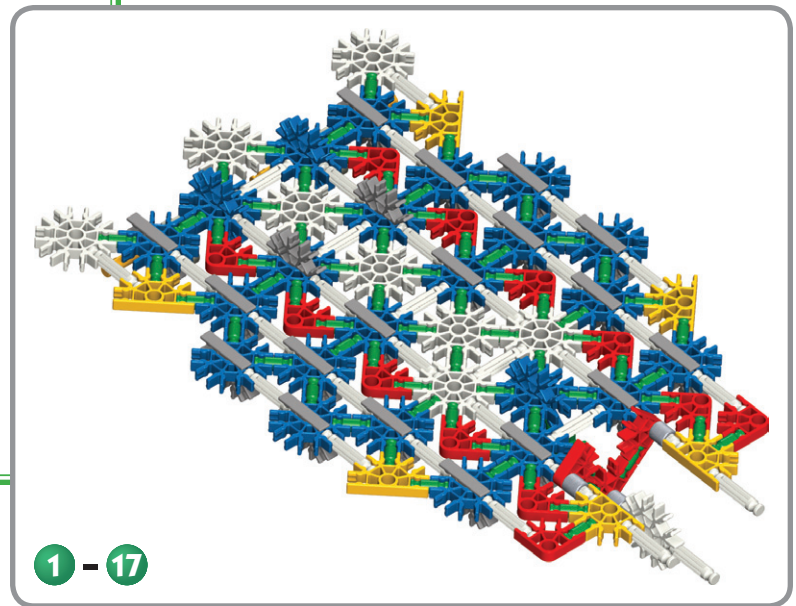
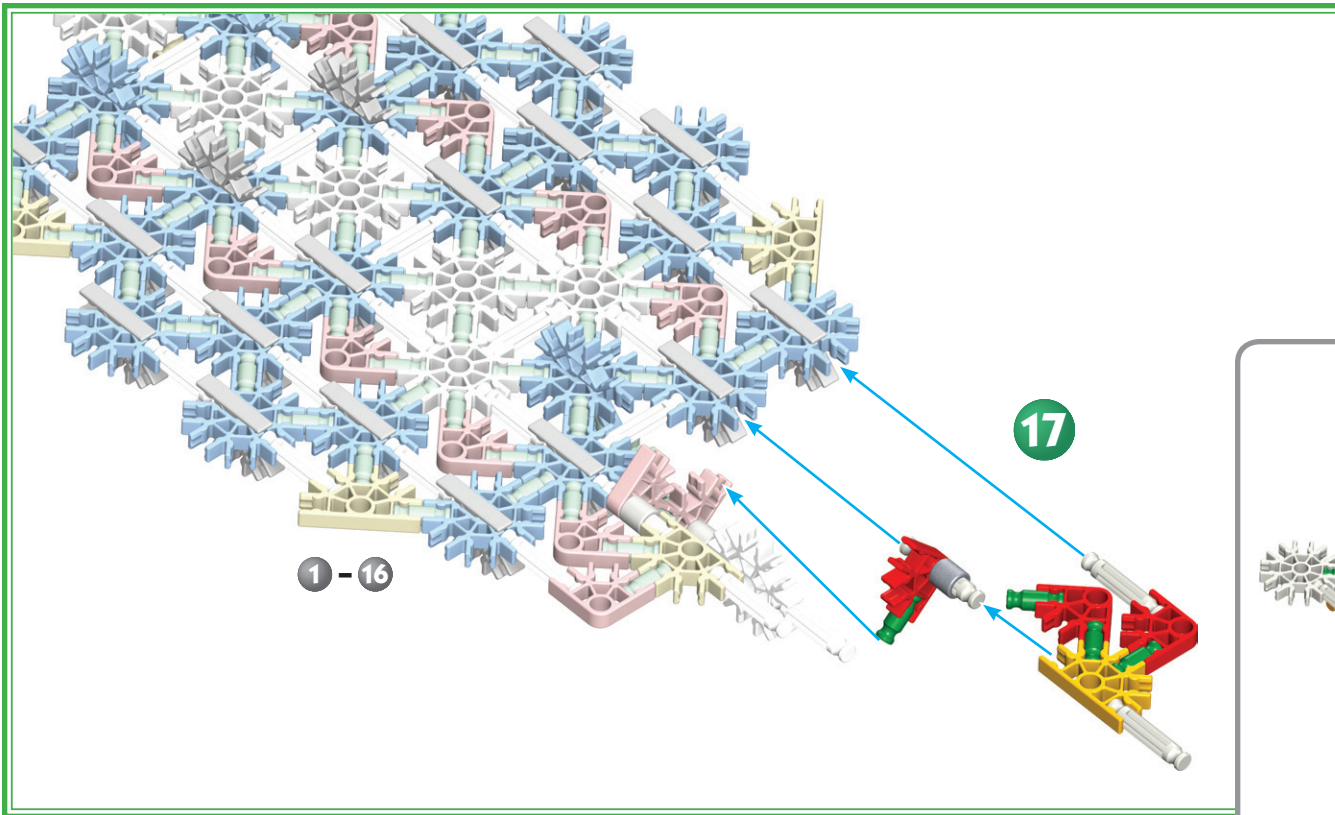

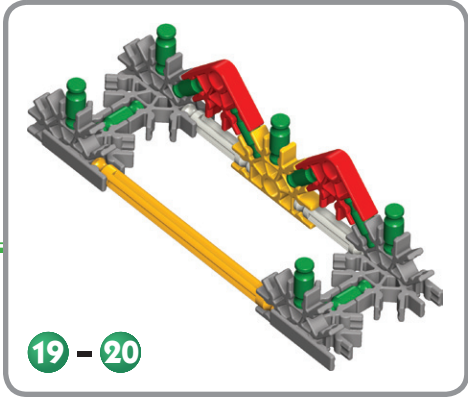
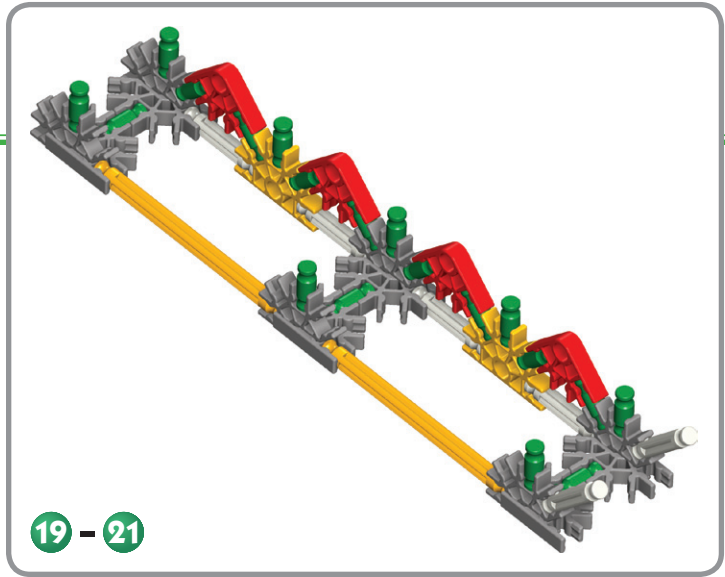
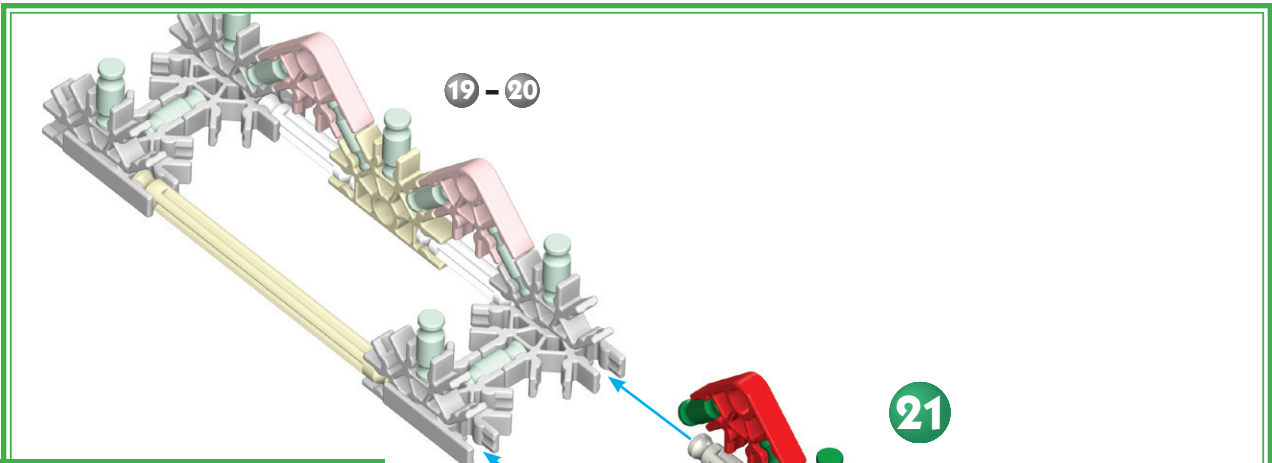
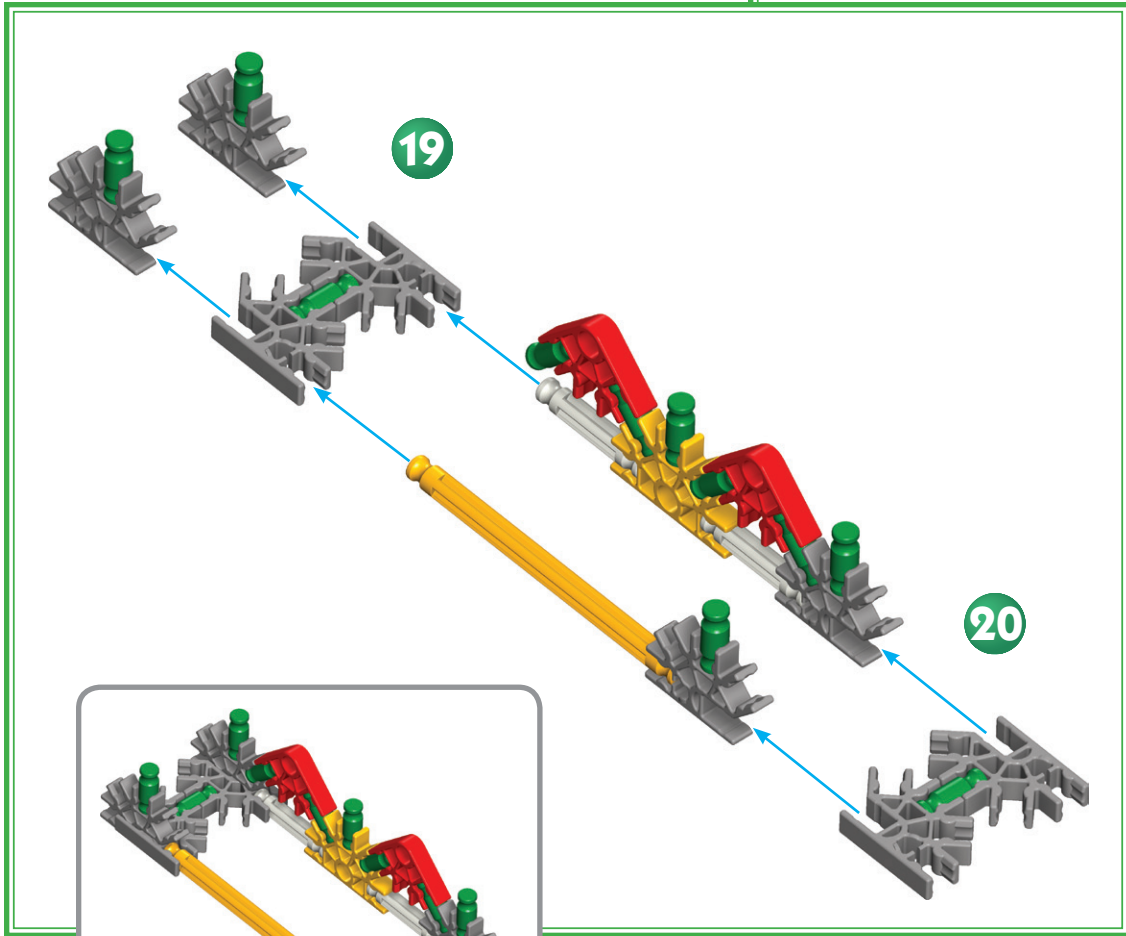

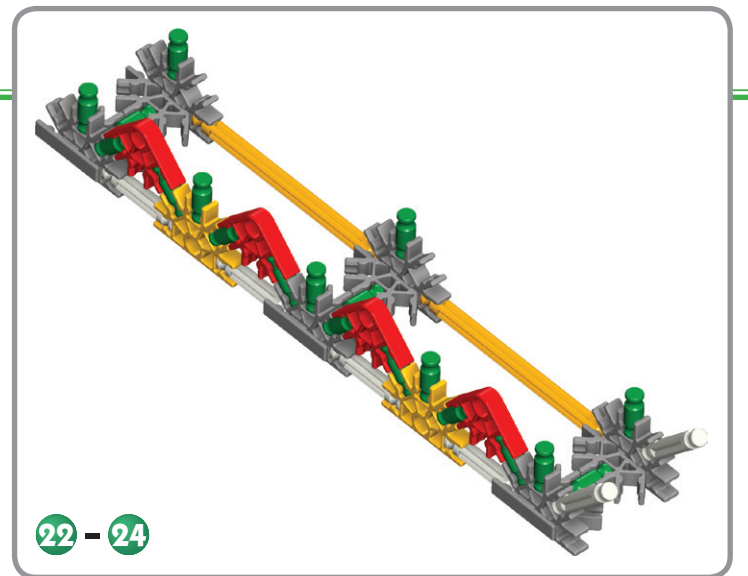
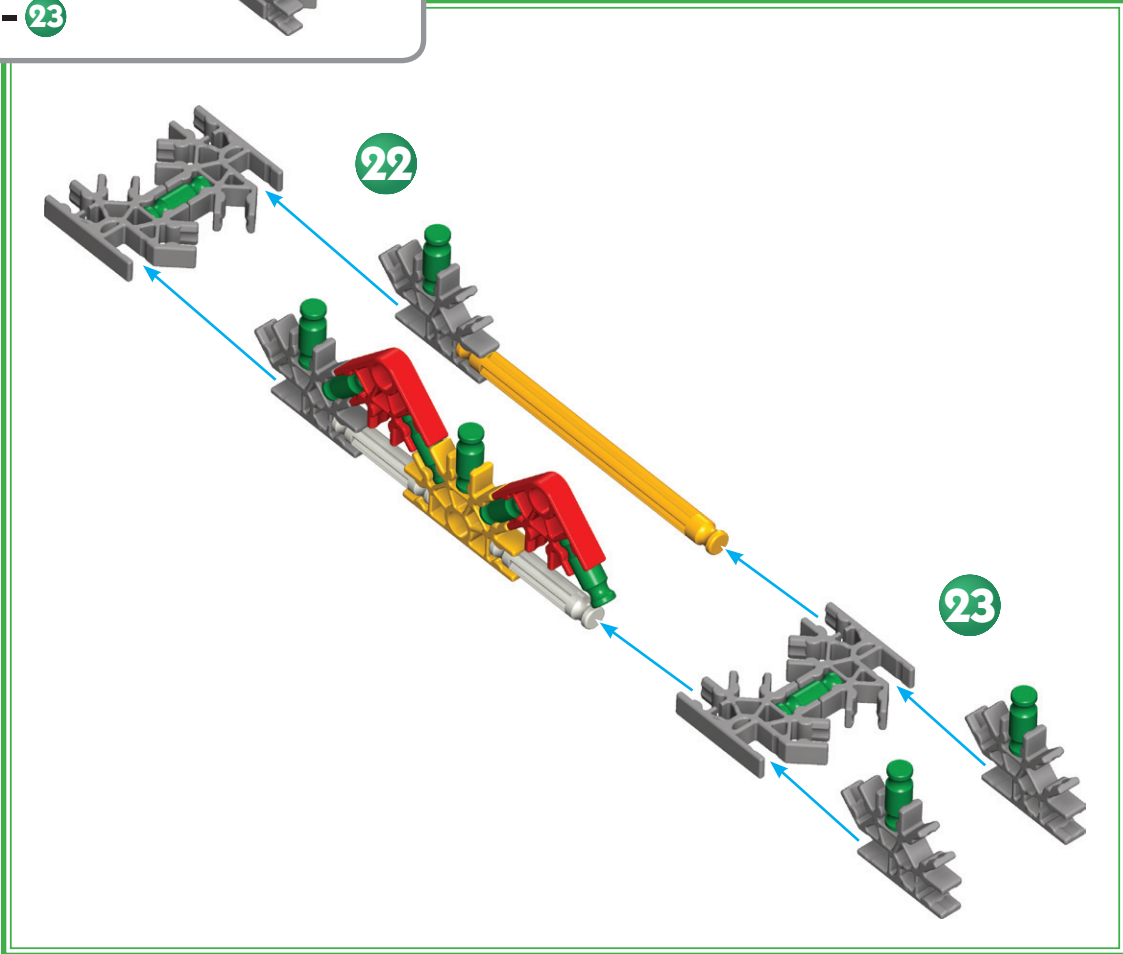
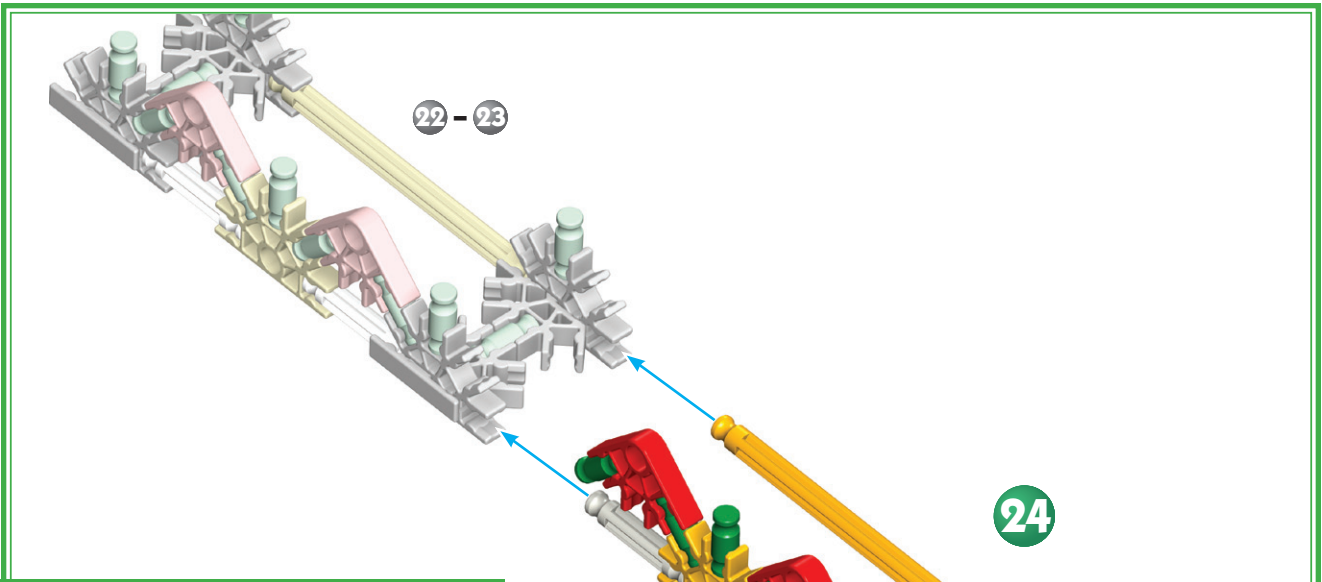
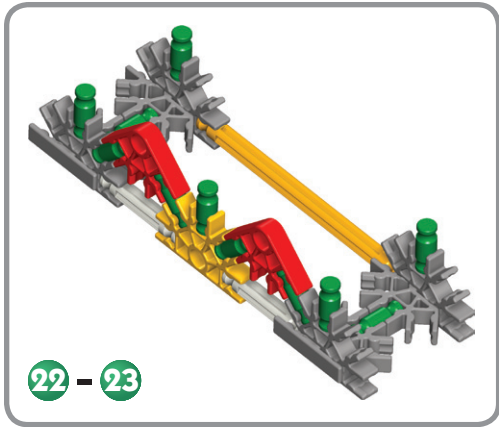

Turn Model Over

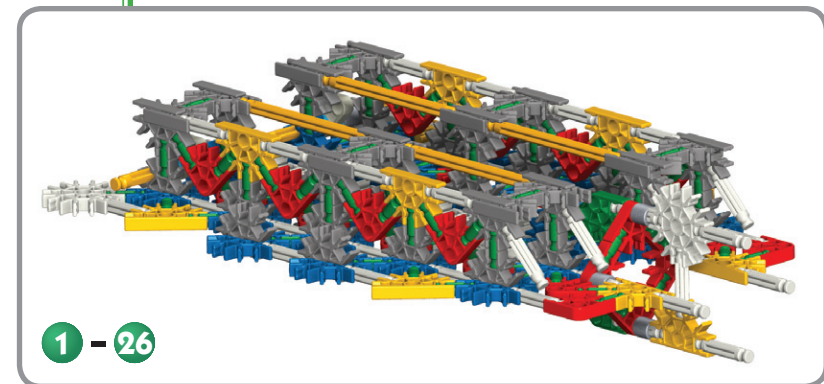
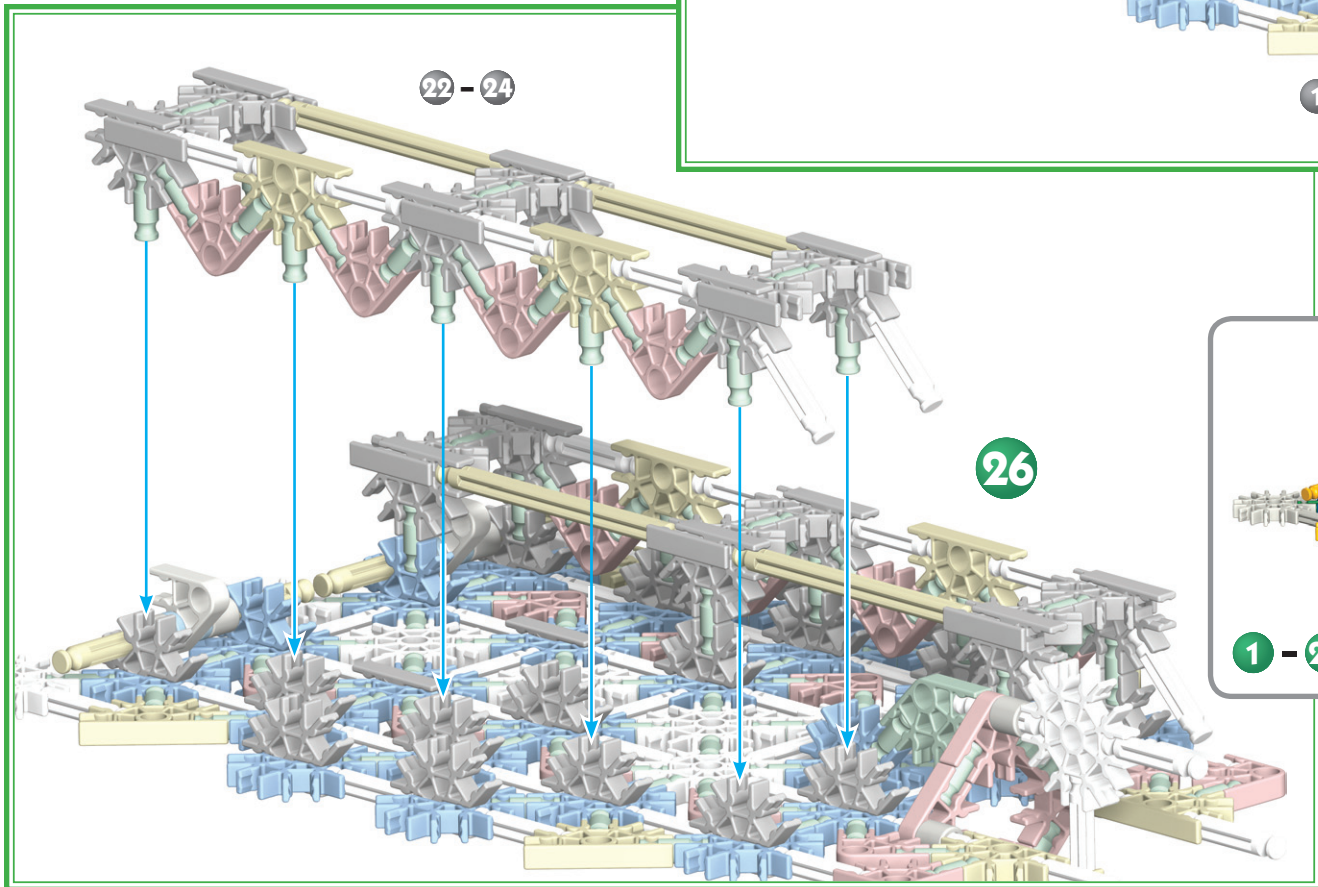
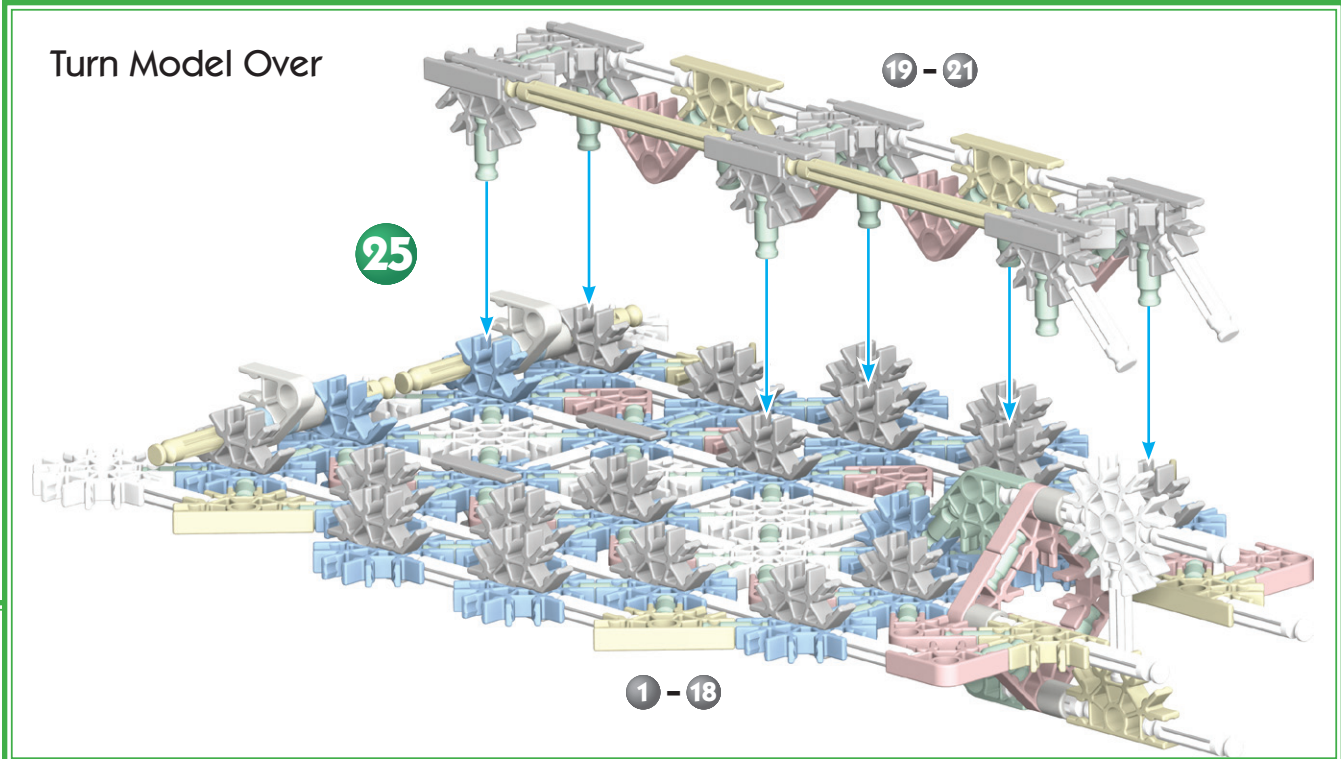

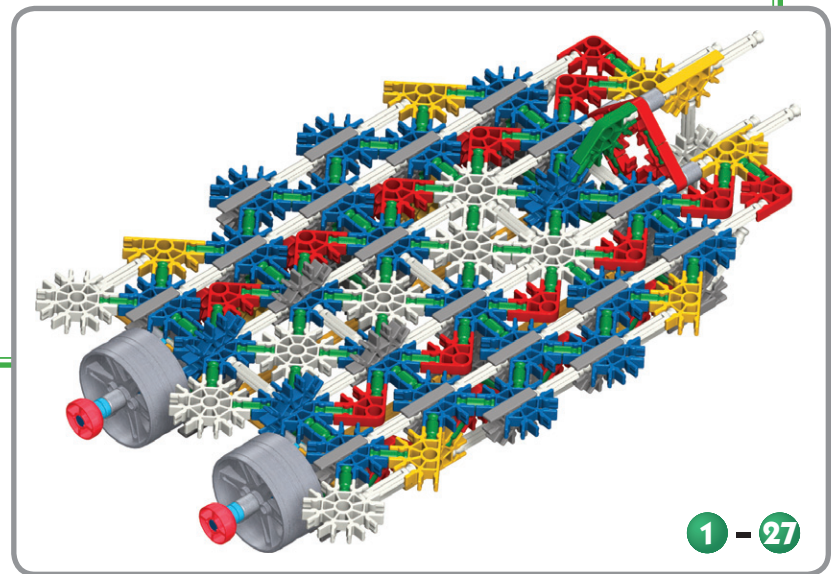
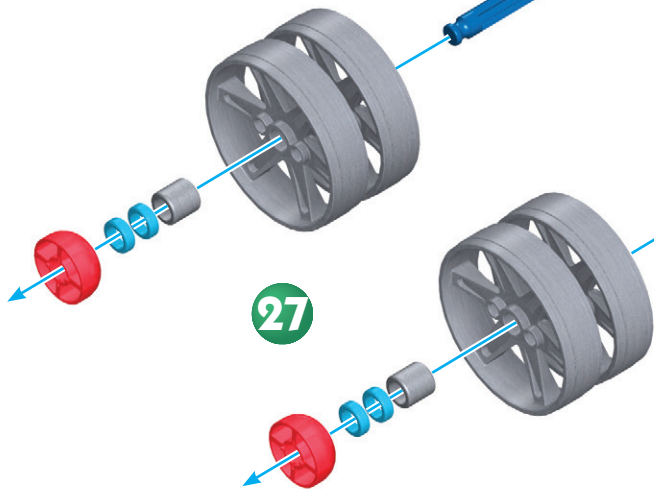
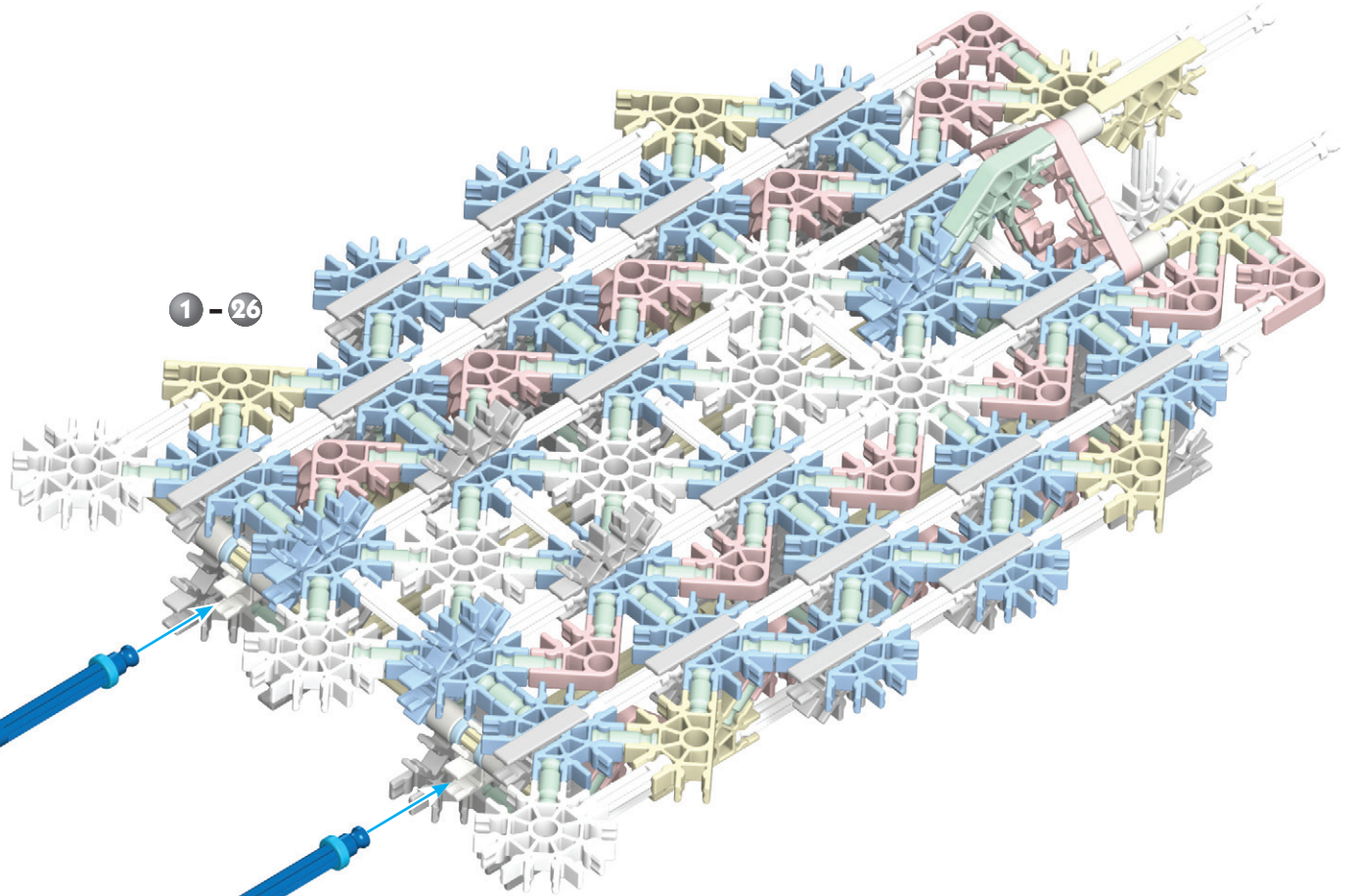

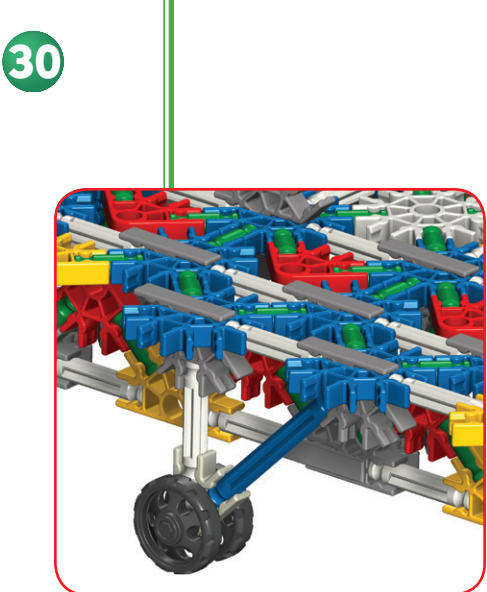
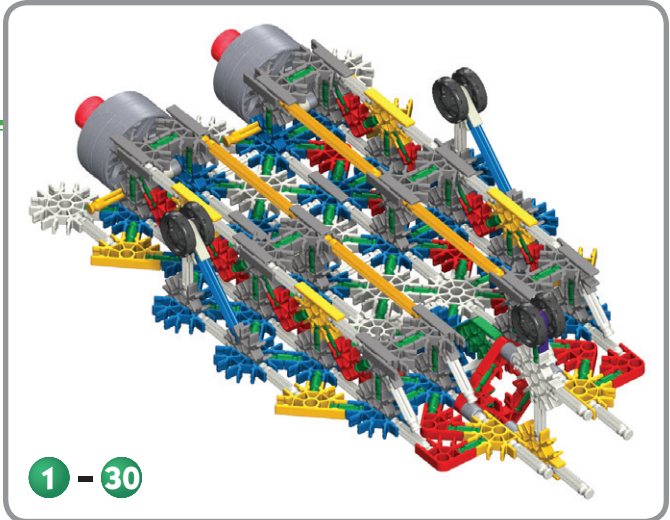
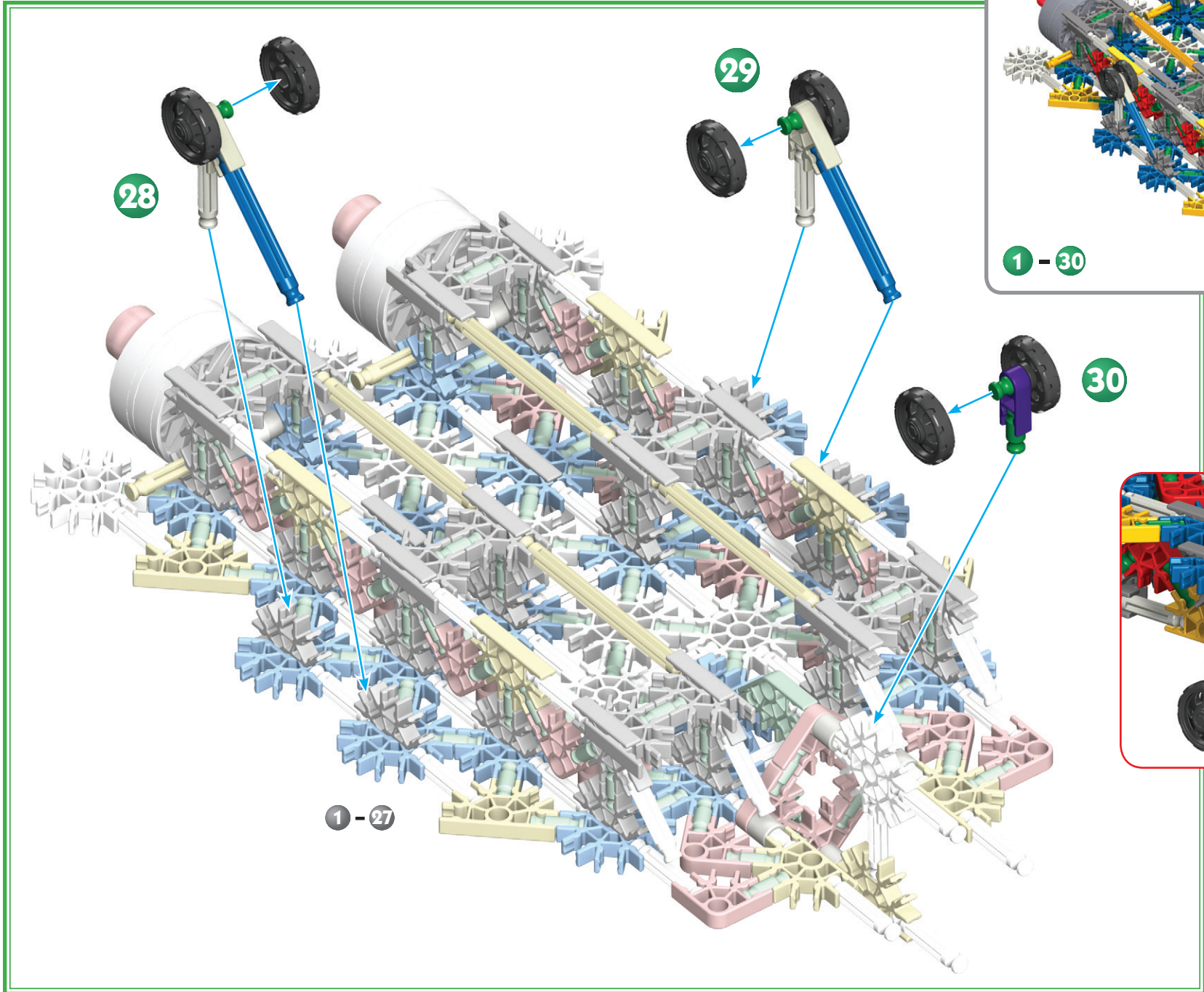

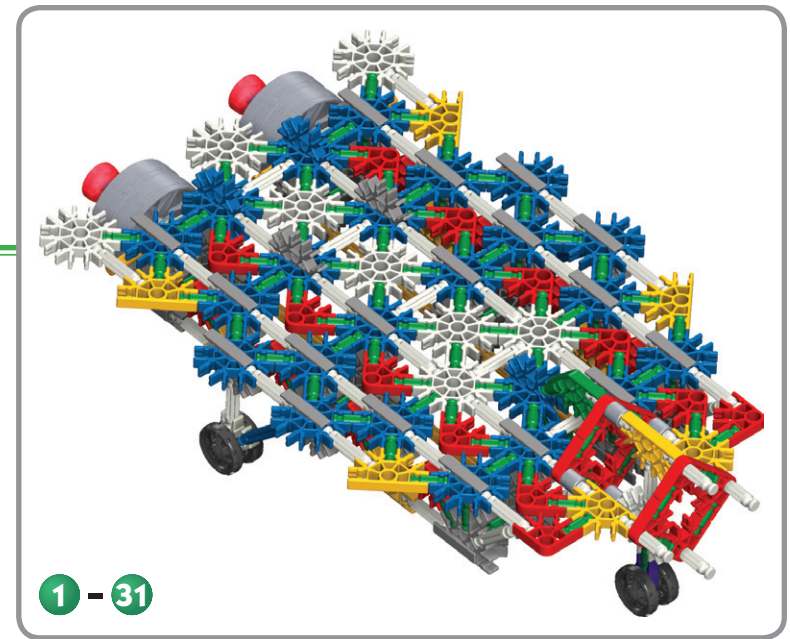
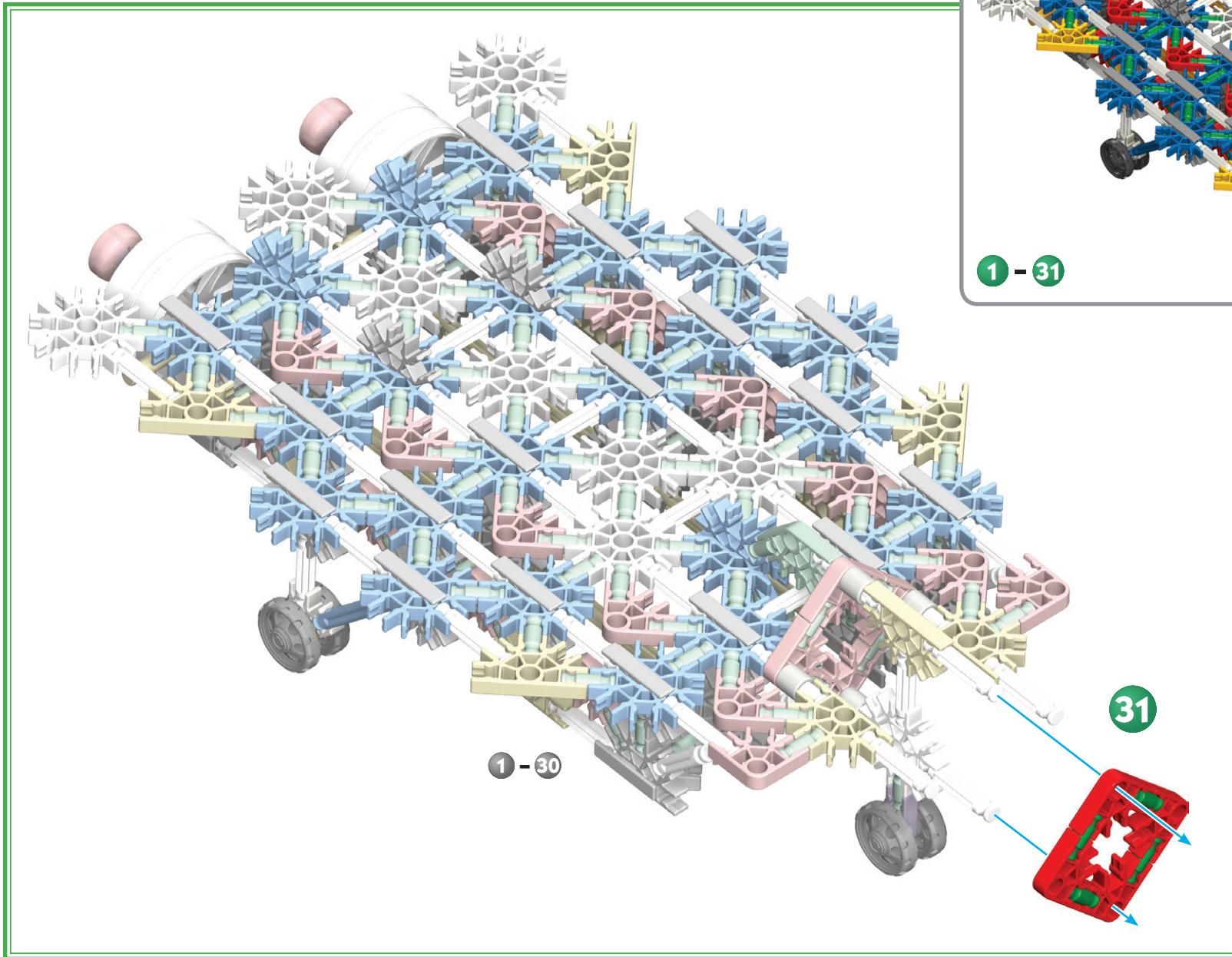

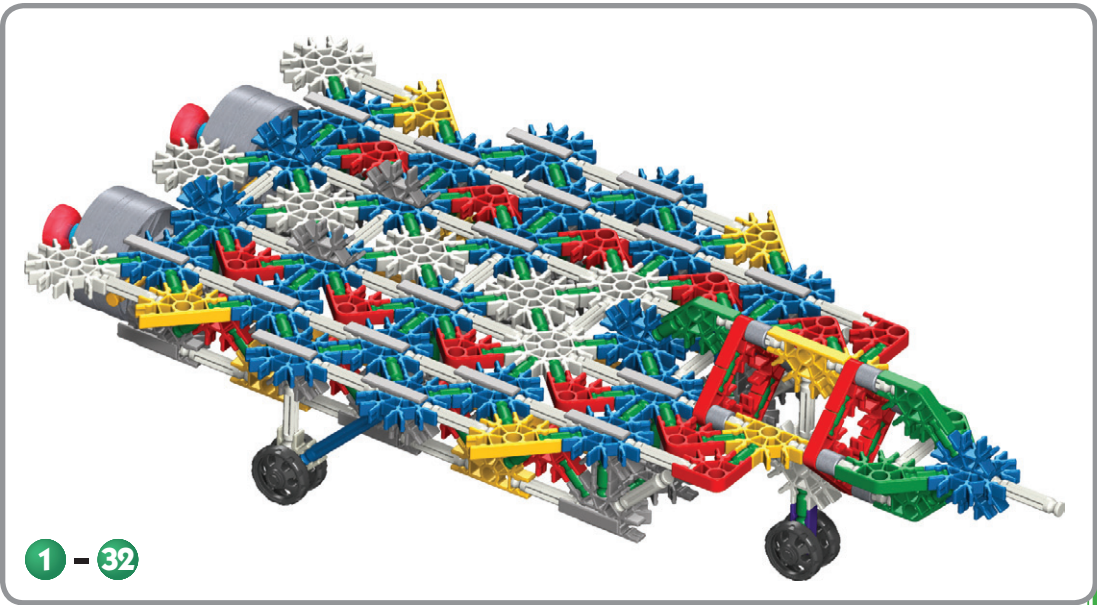
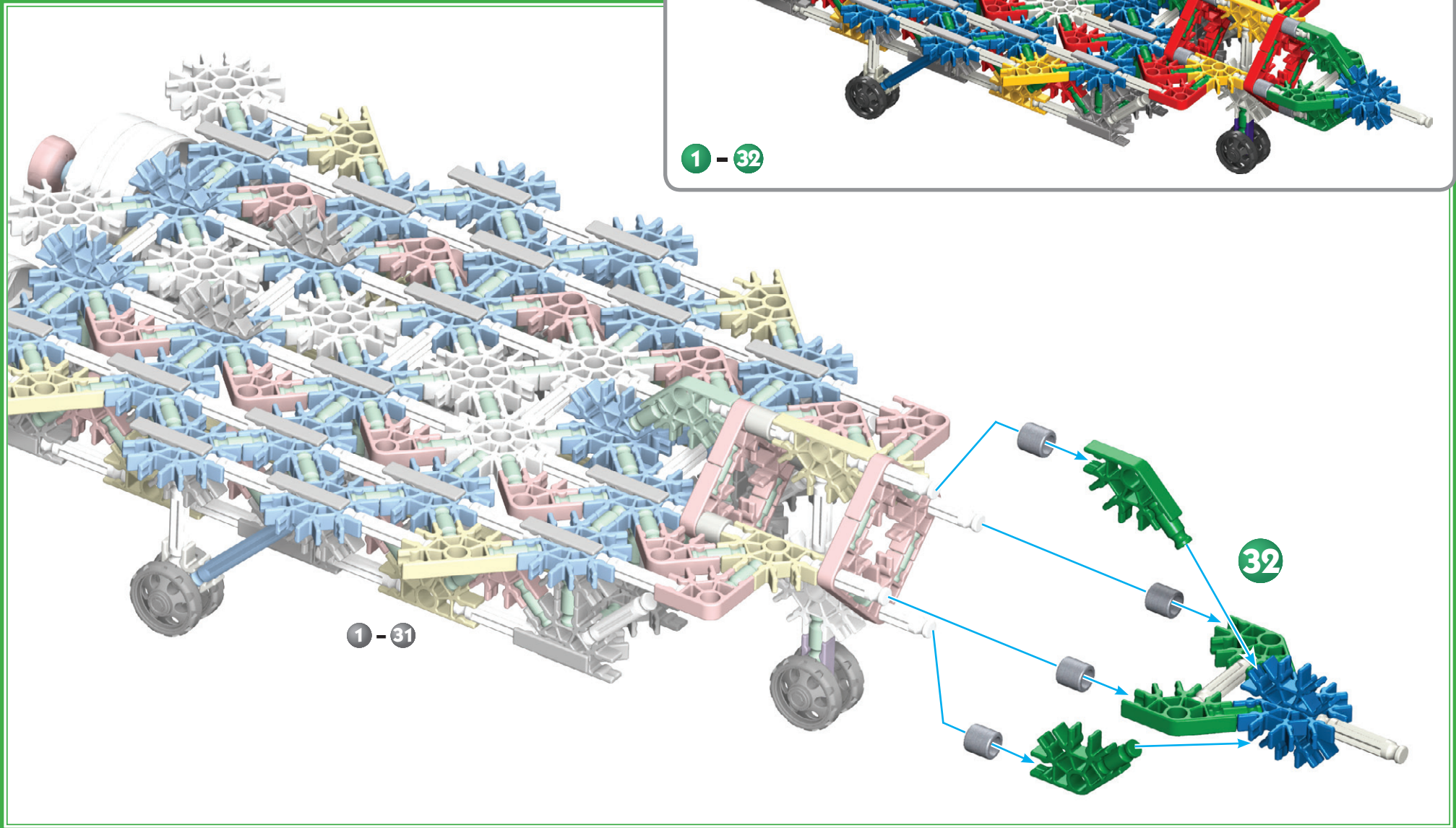

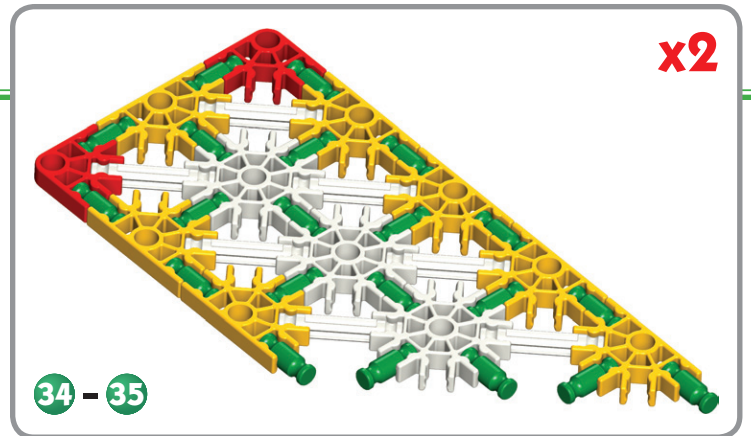
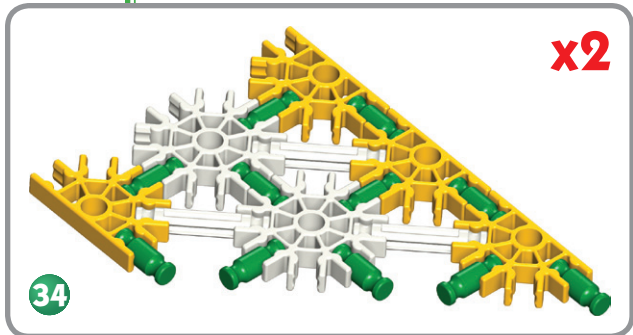
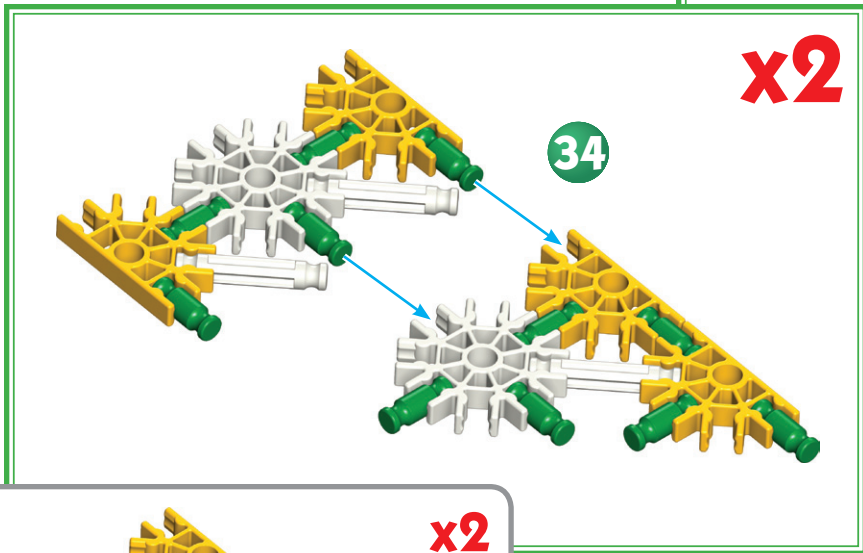
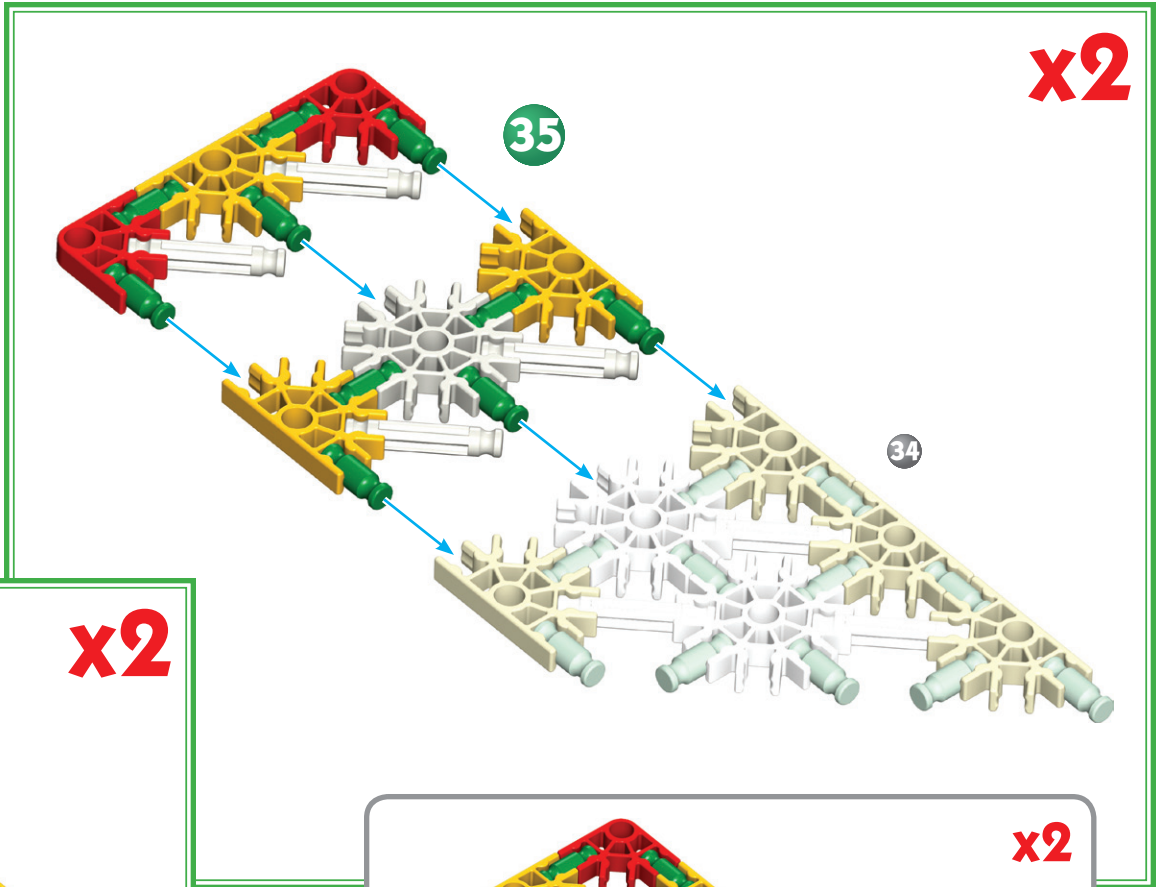
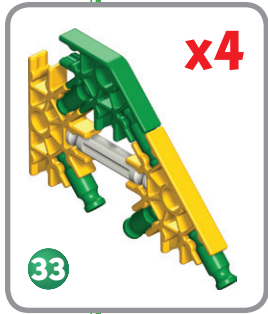
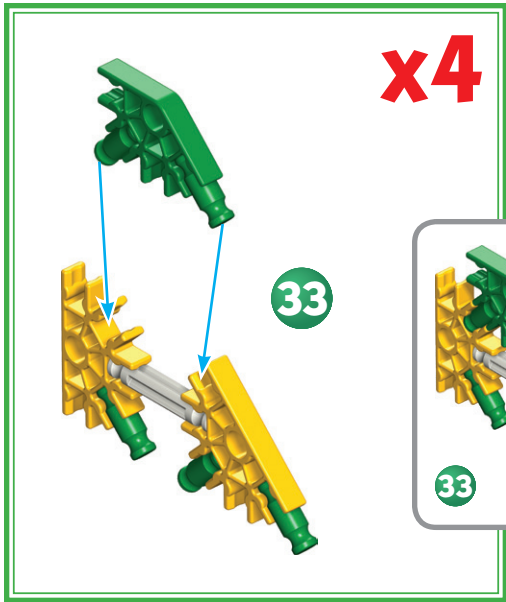

# F-14 Jet

