

F-14 Jet

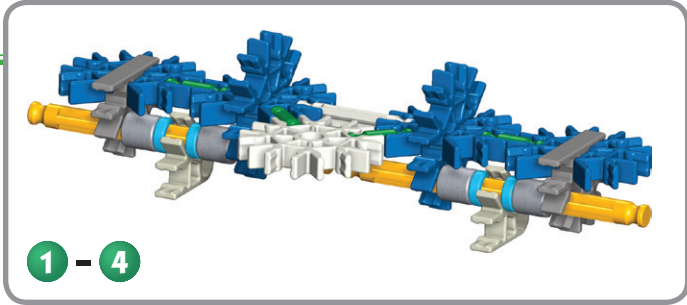

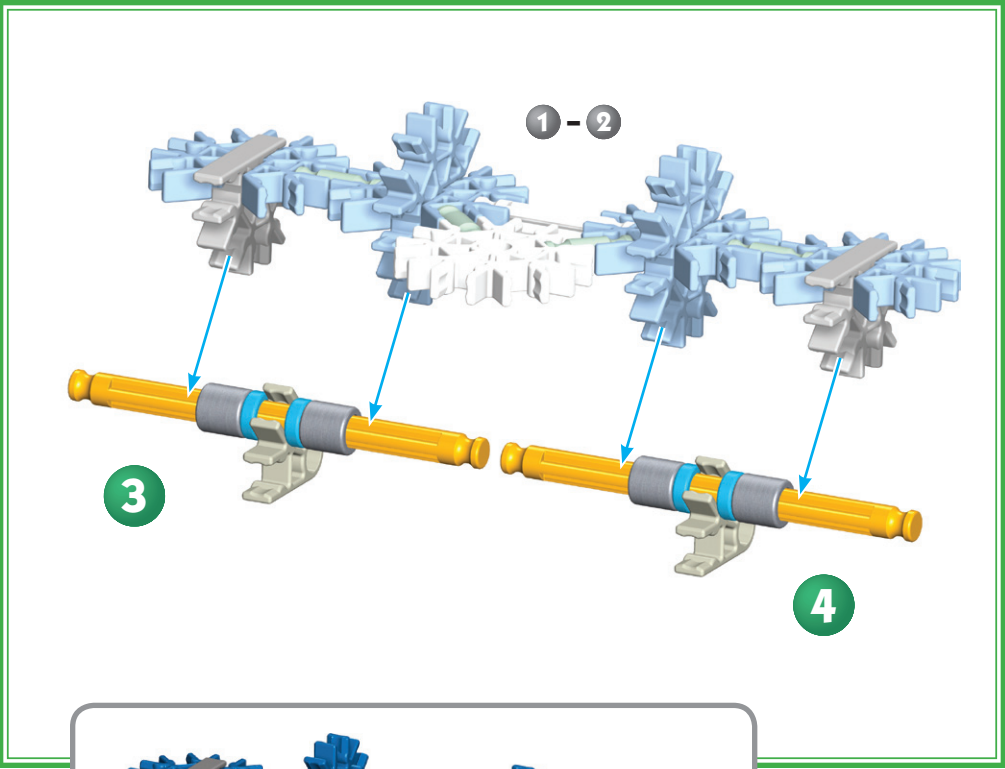

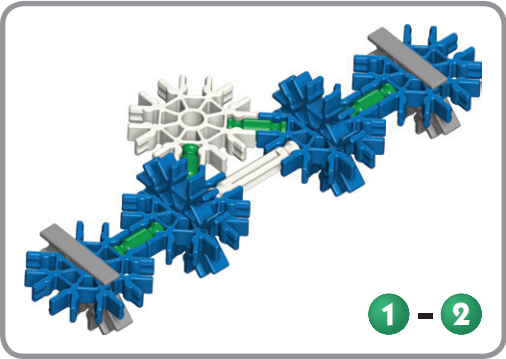

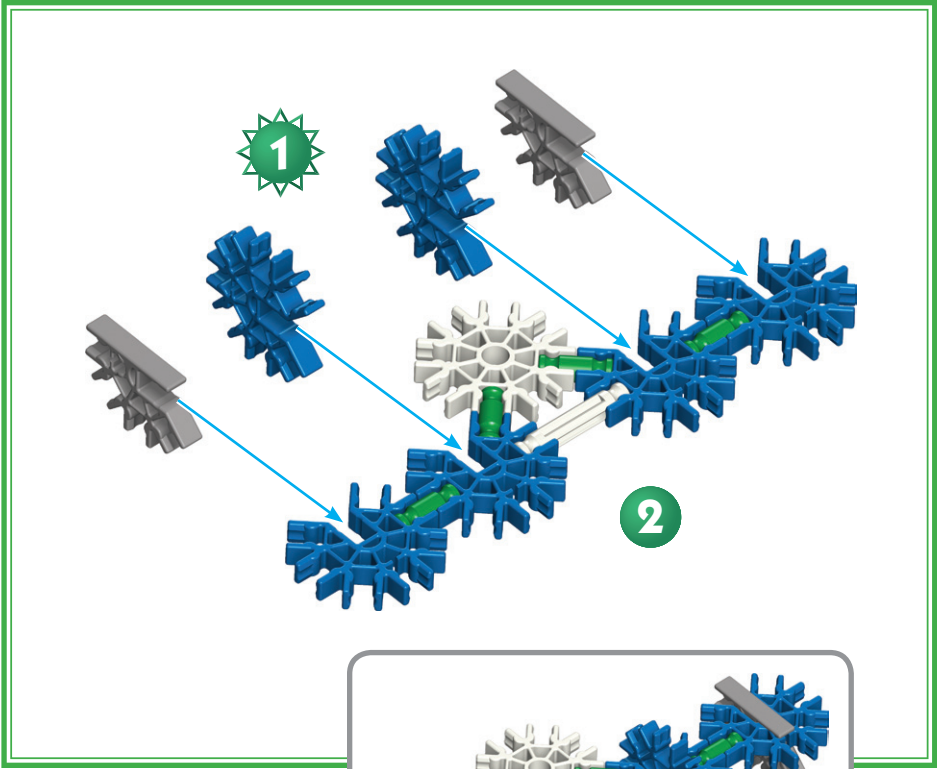
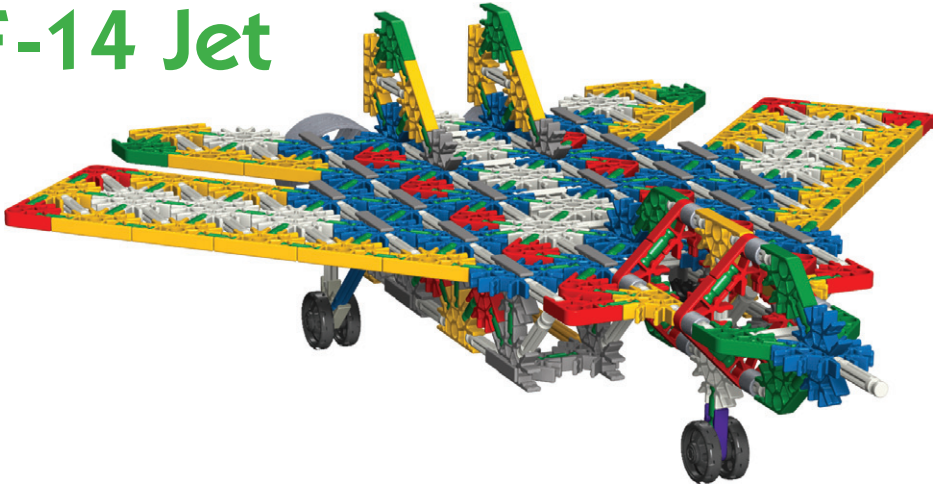
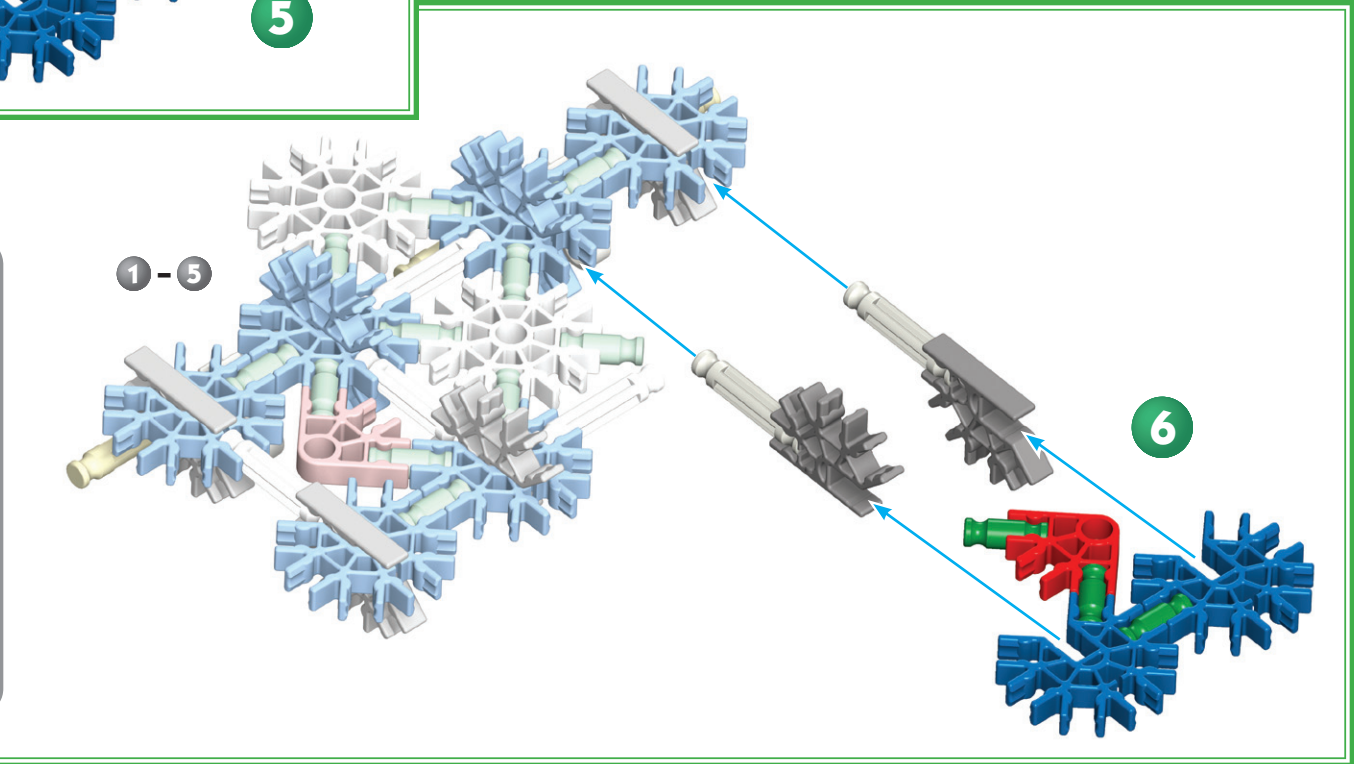
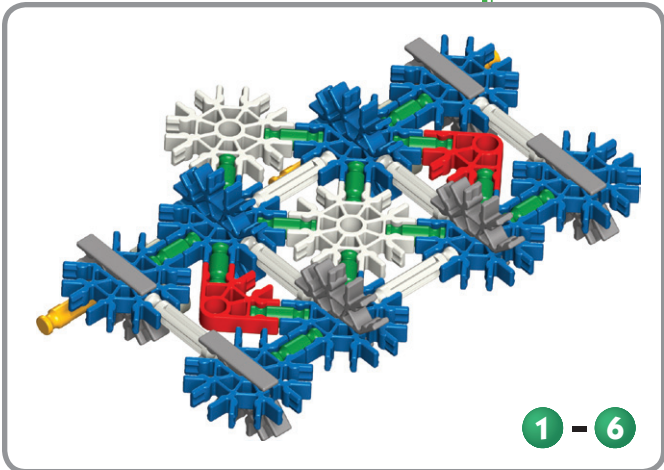
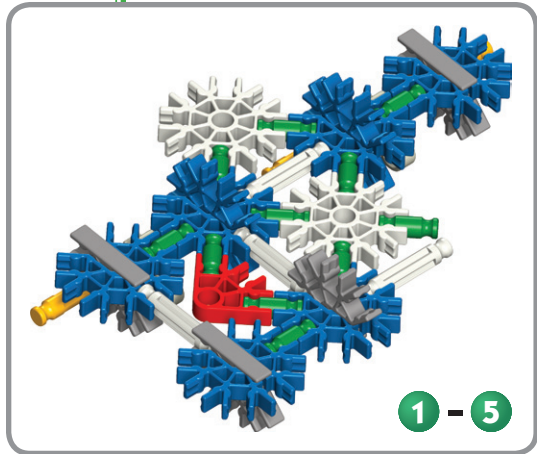
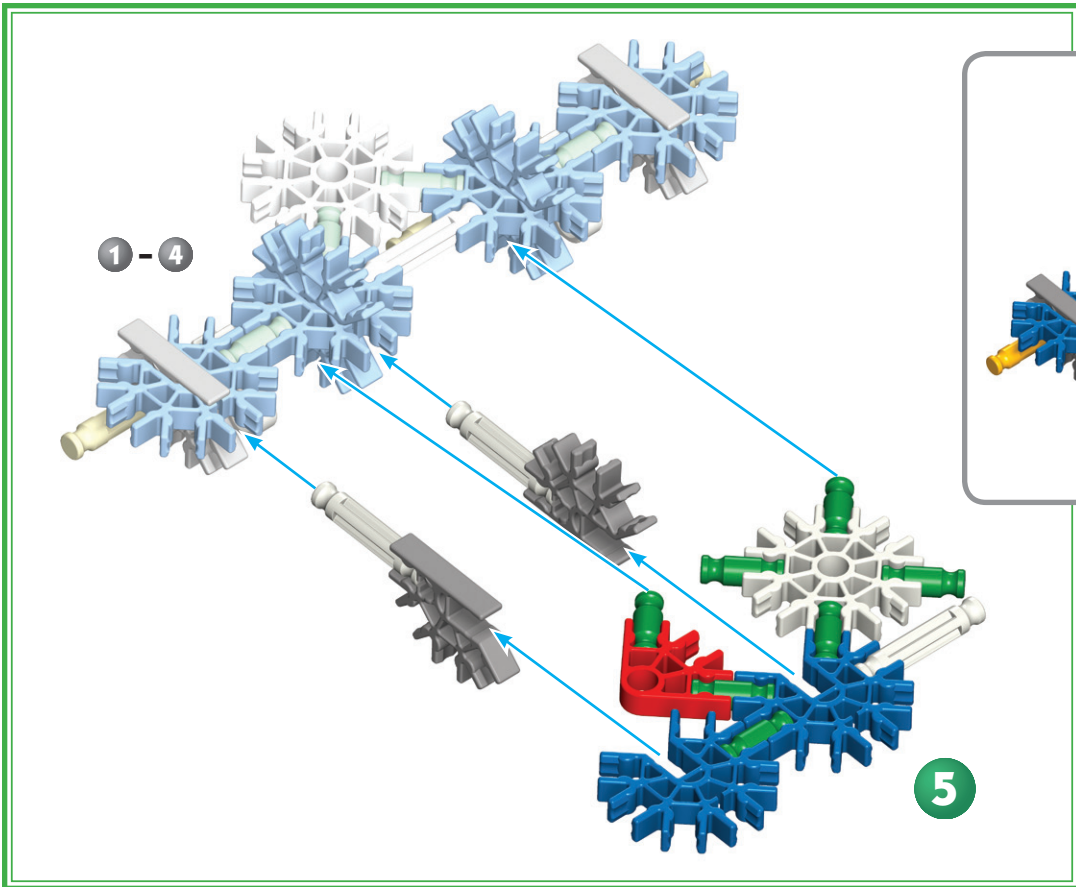
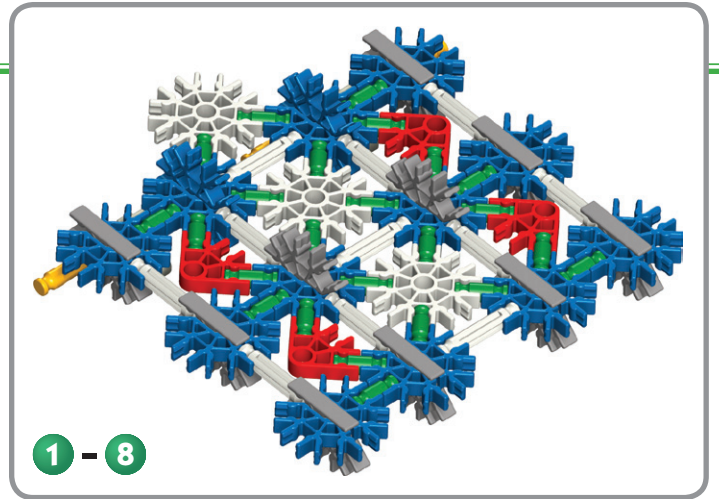
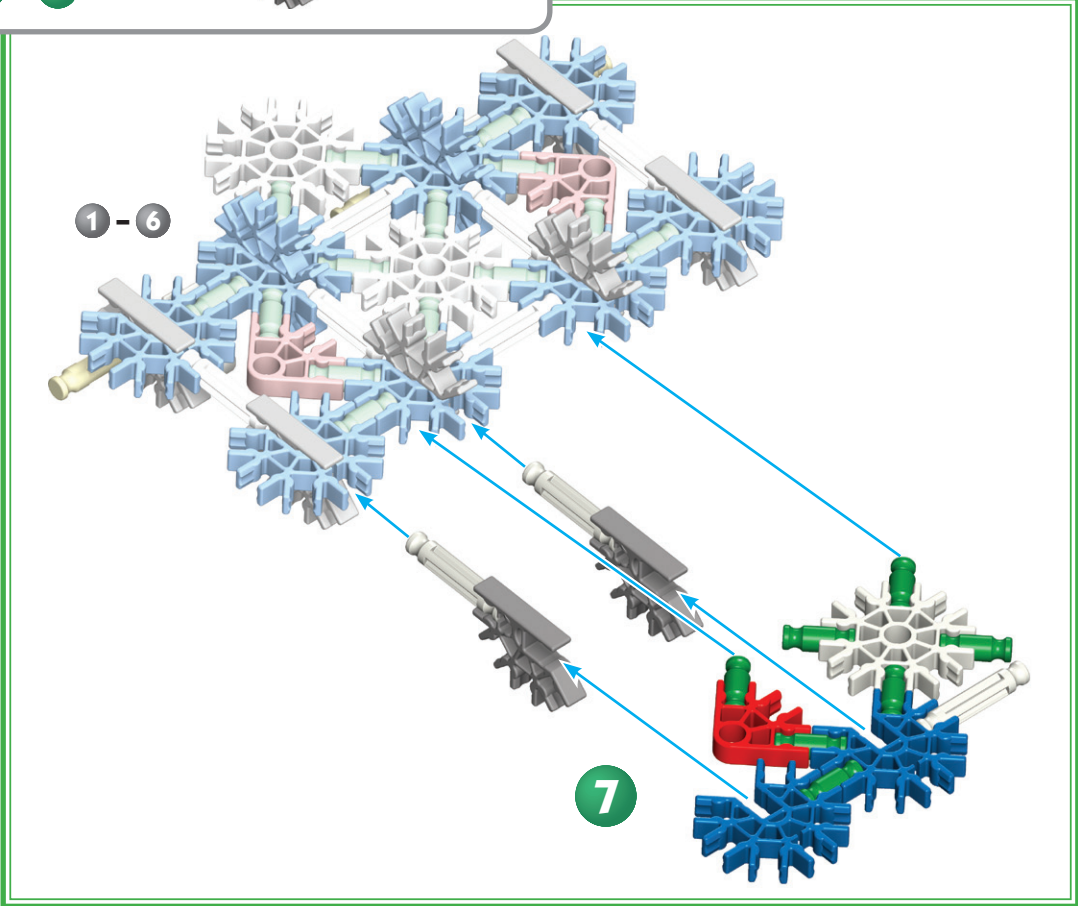
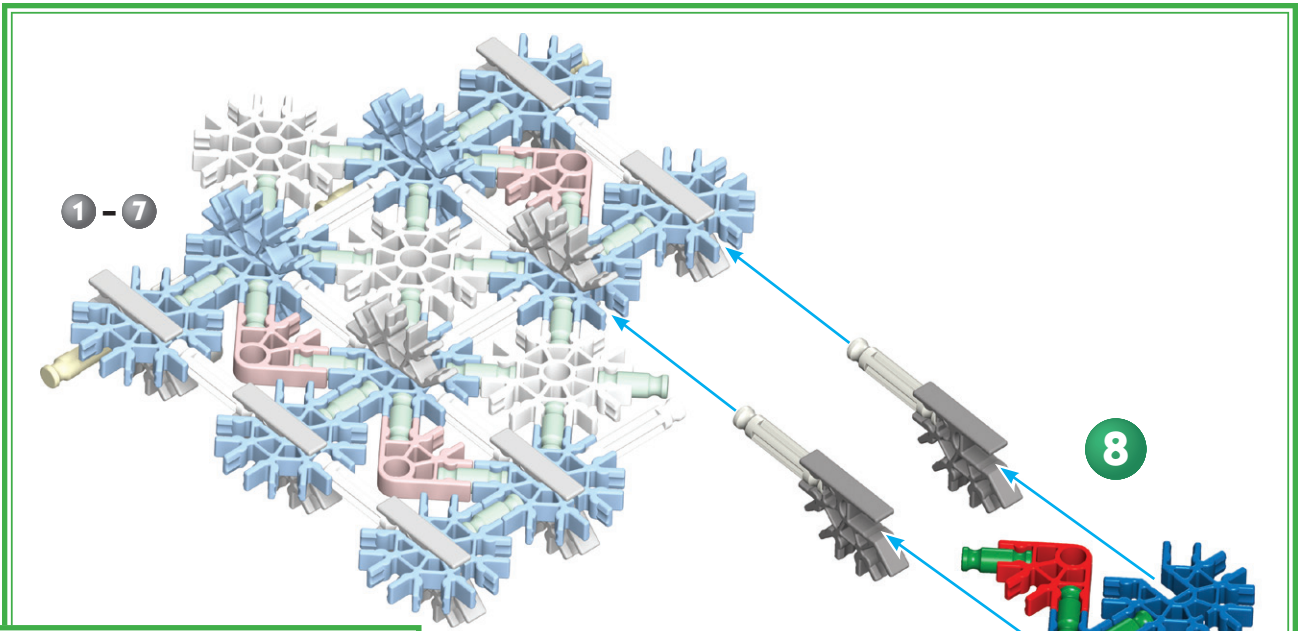
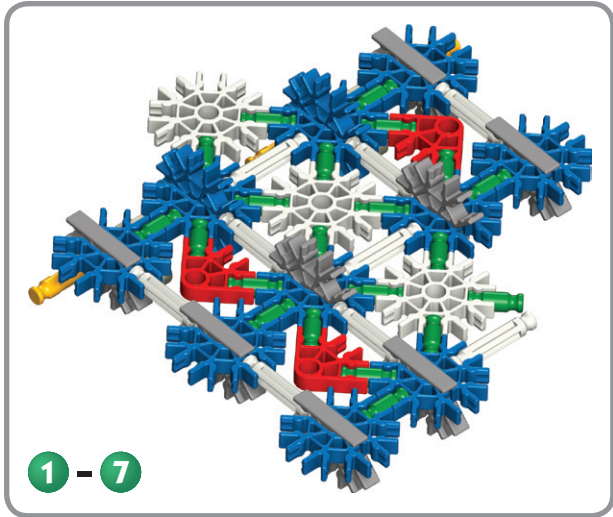
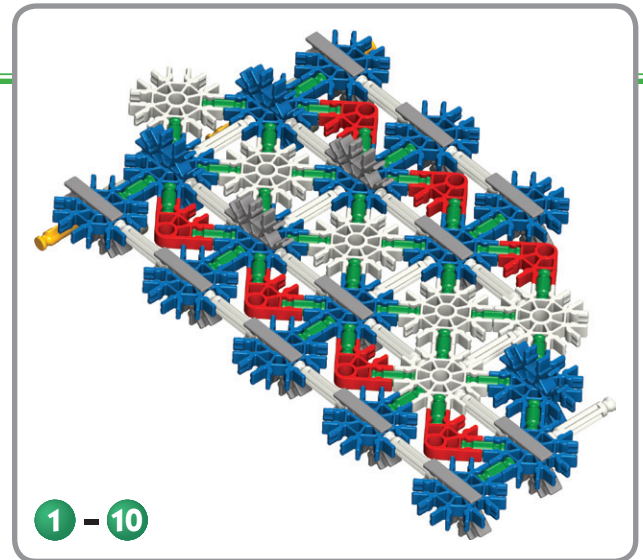
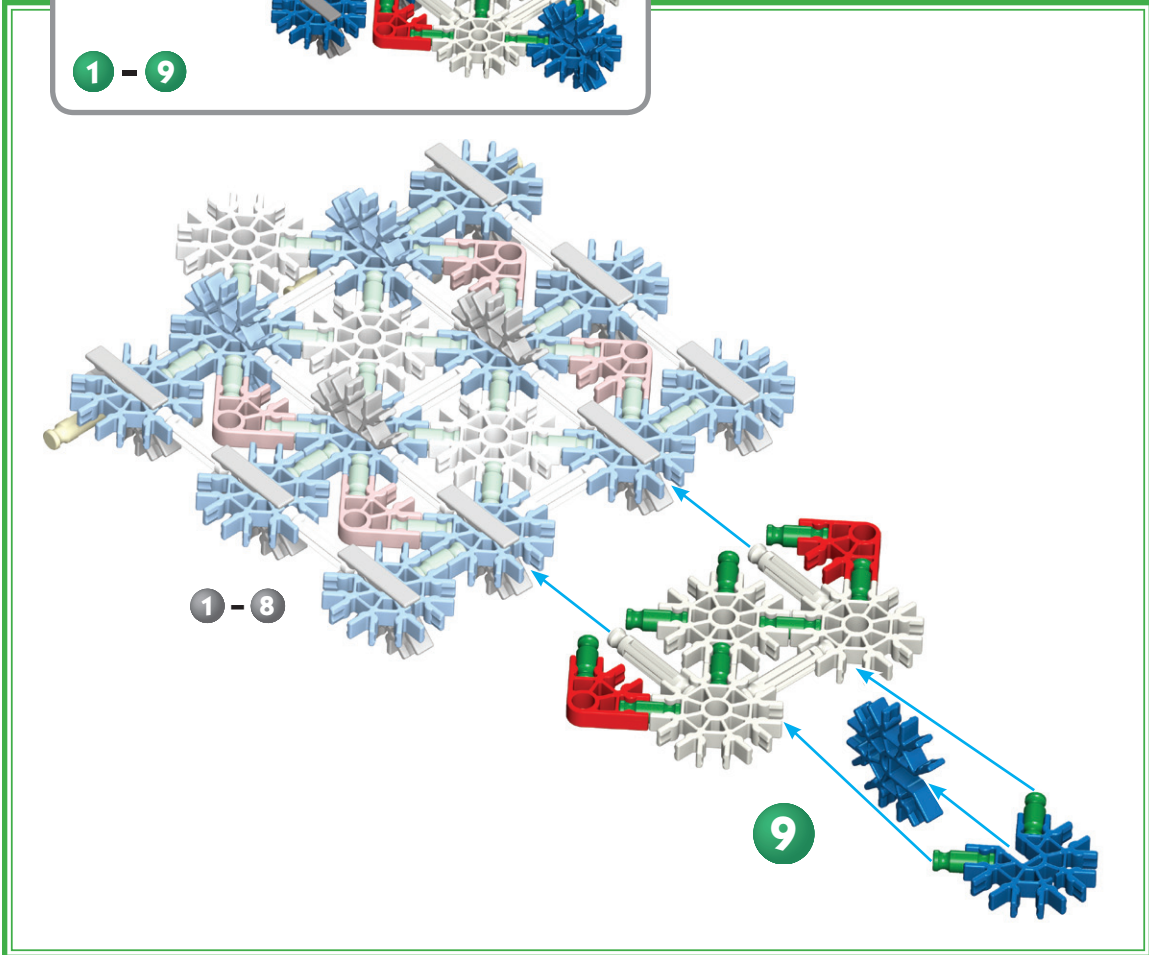
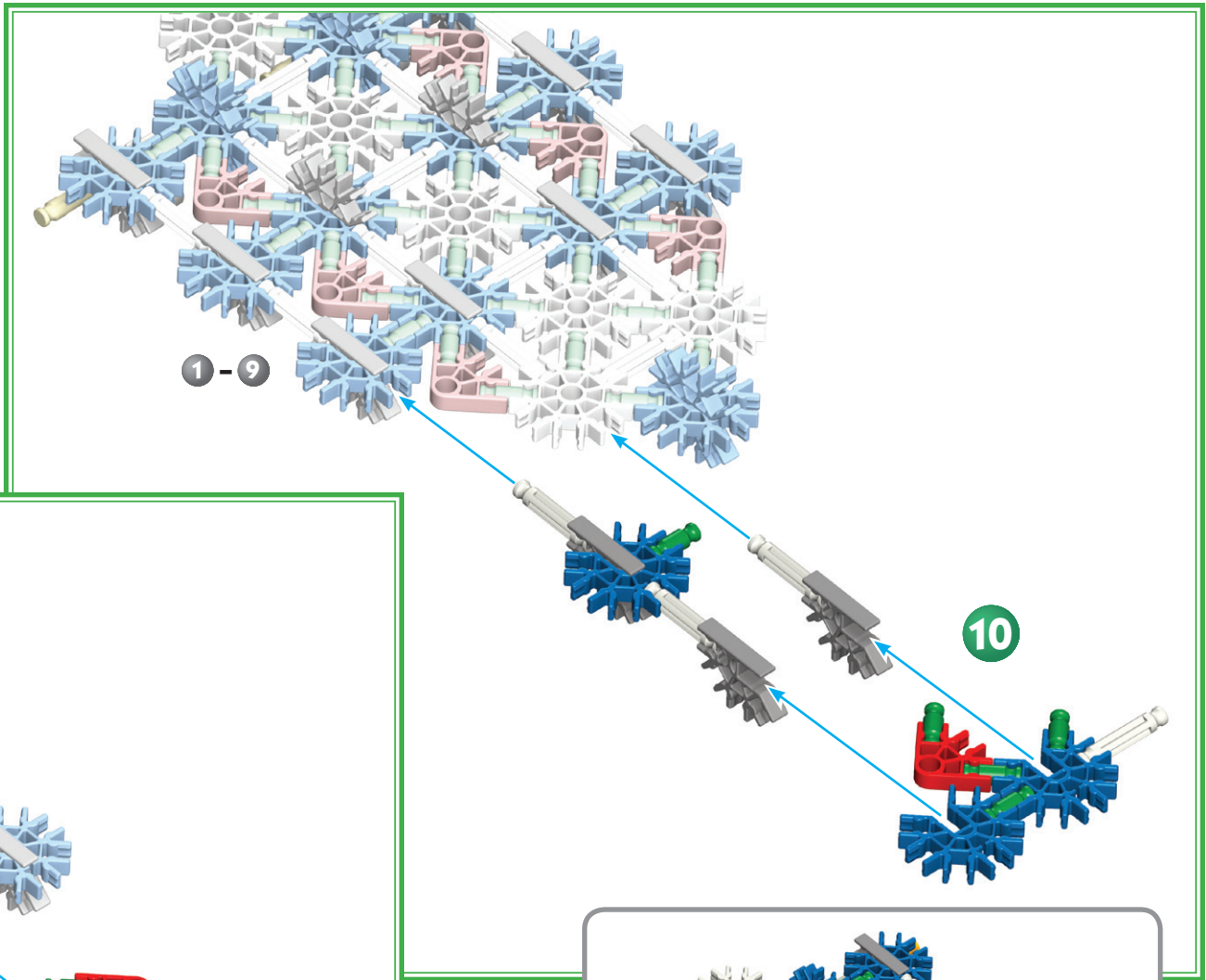
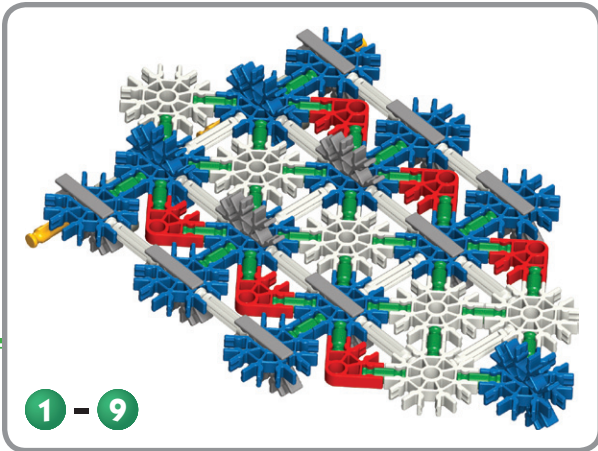

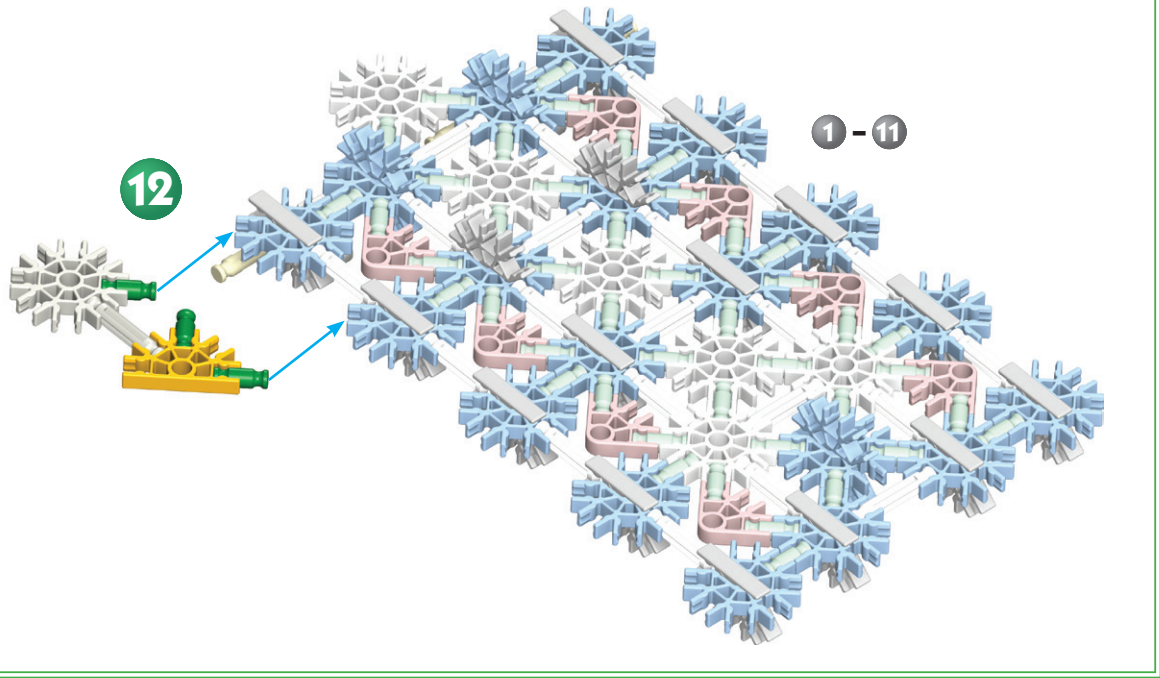
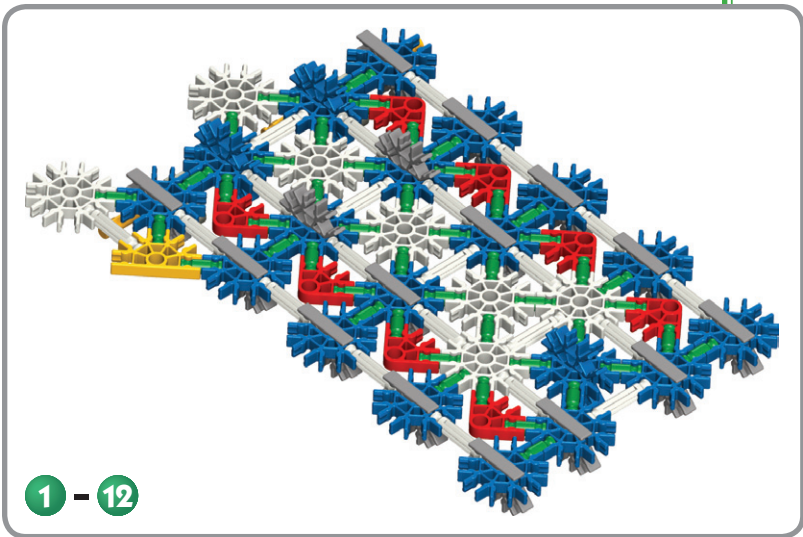
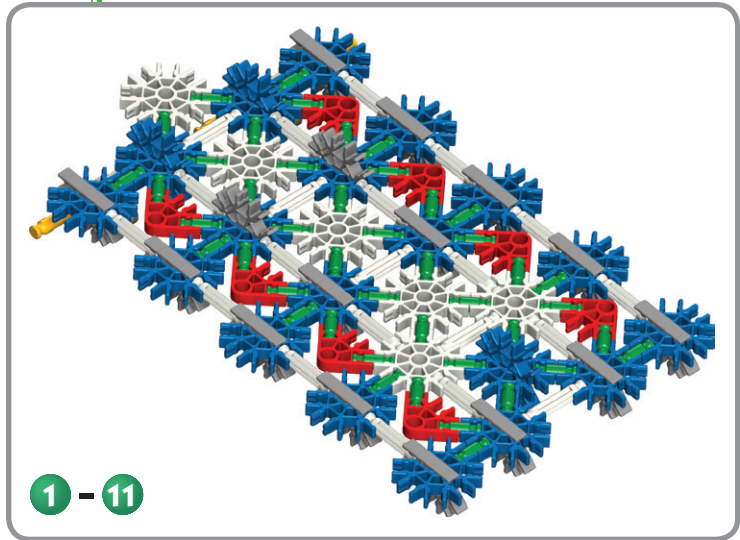
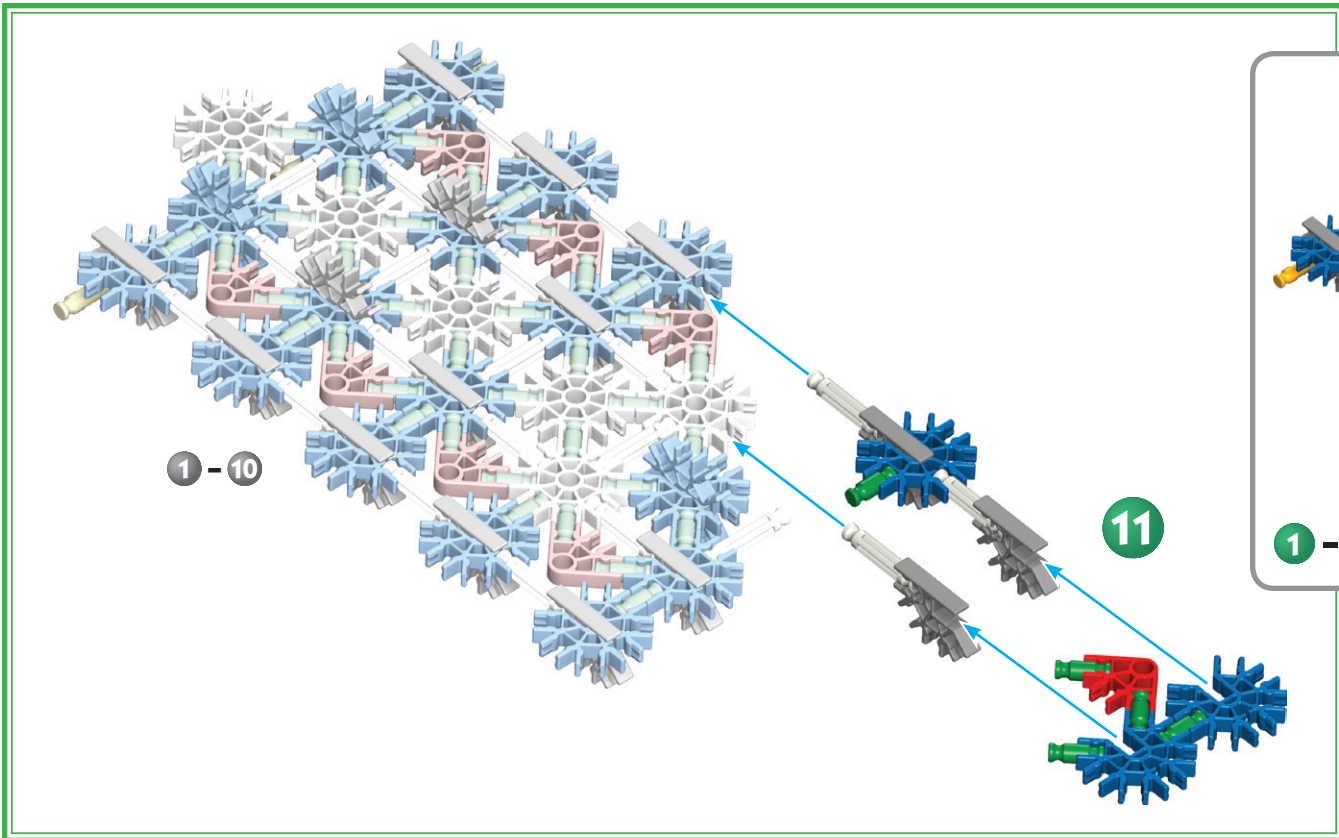

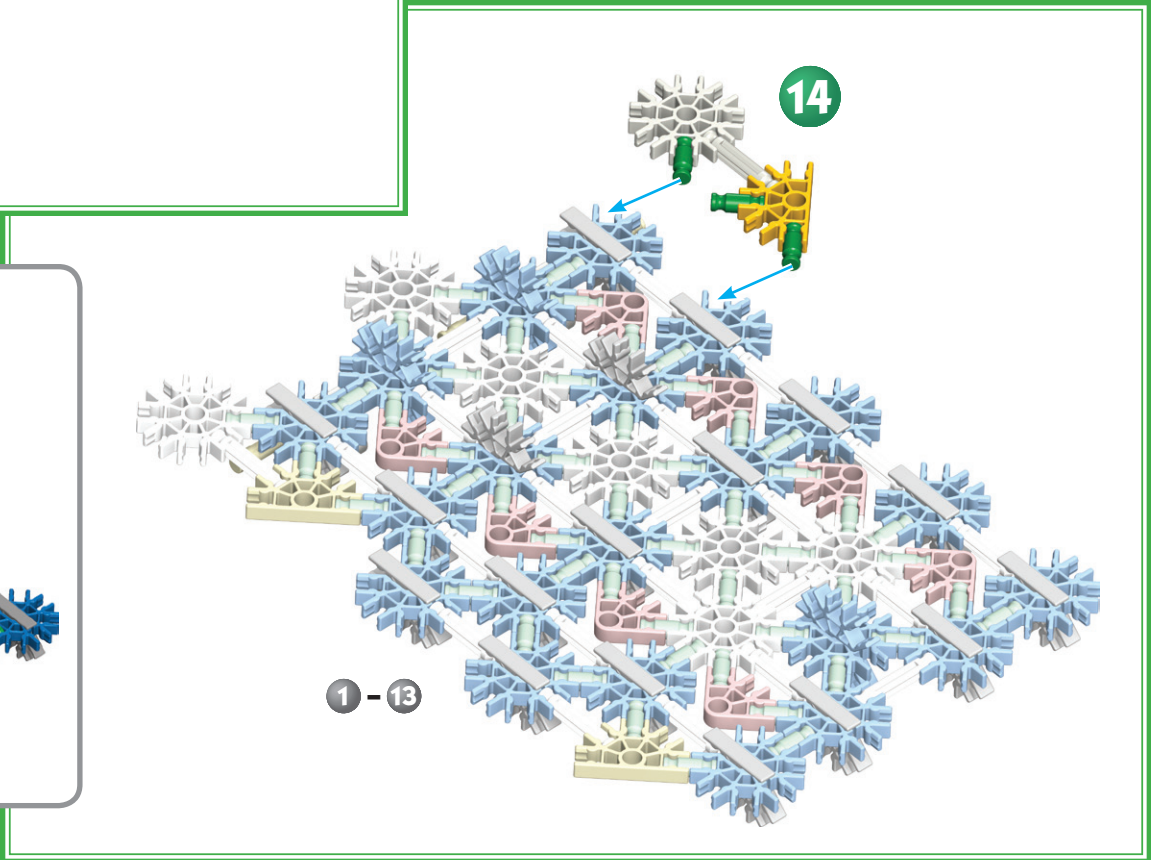
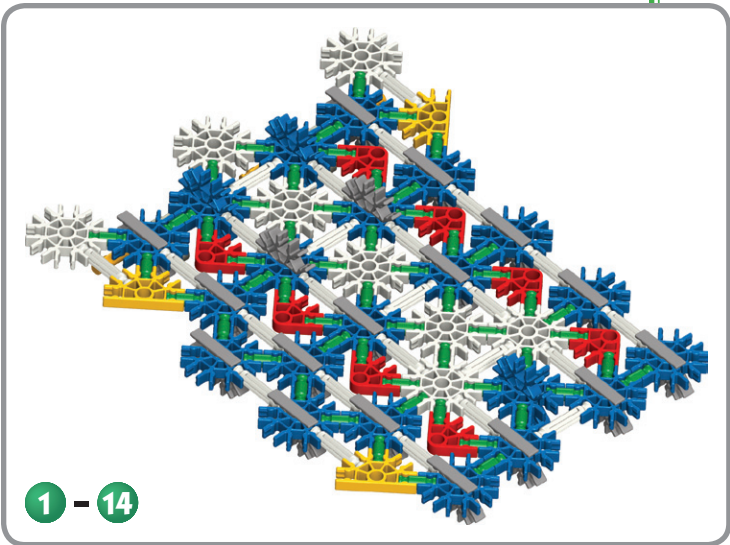
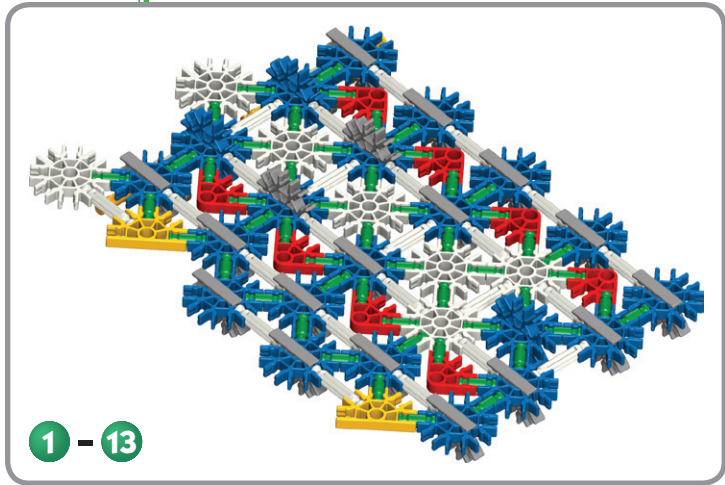
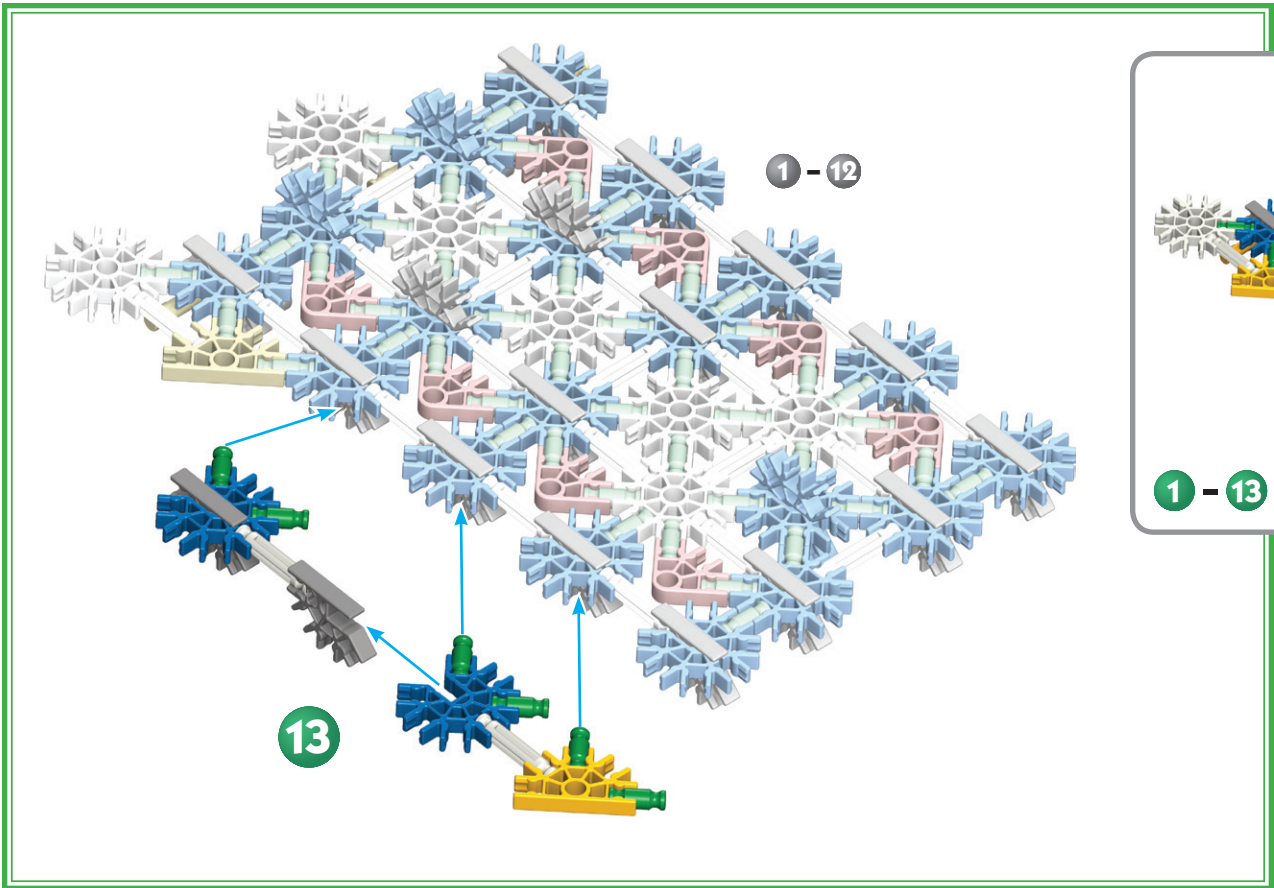

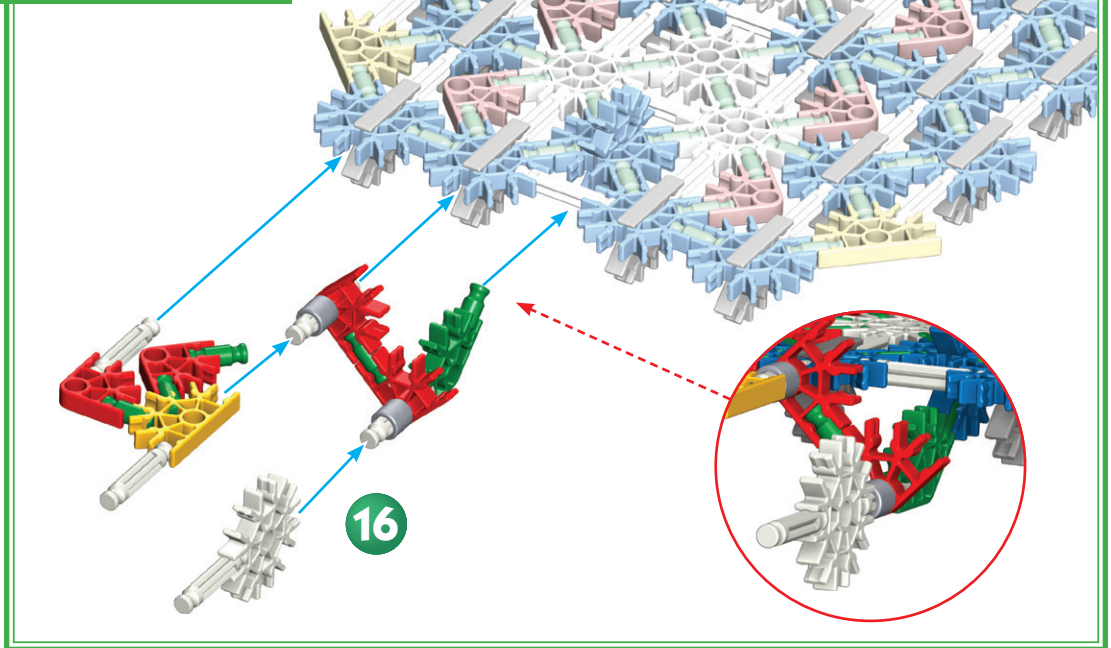
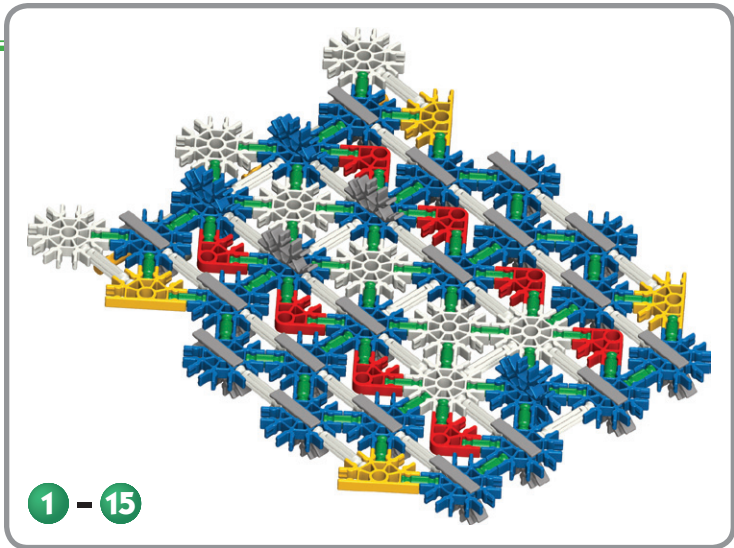
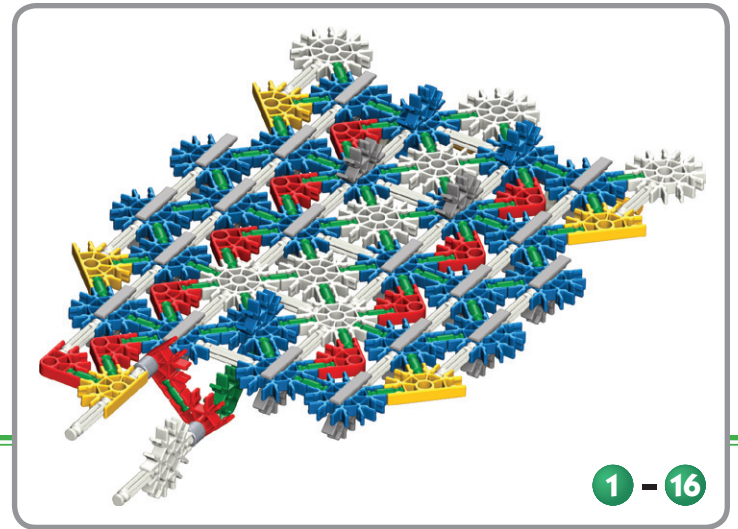
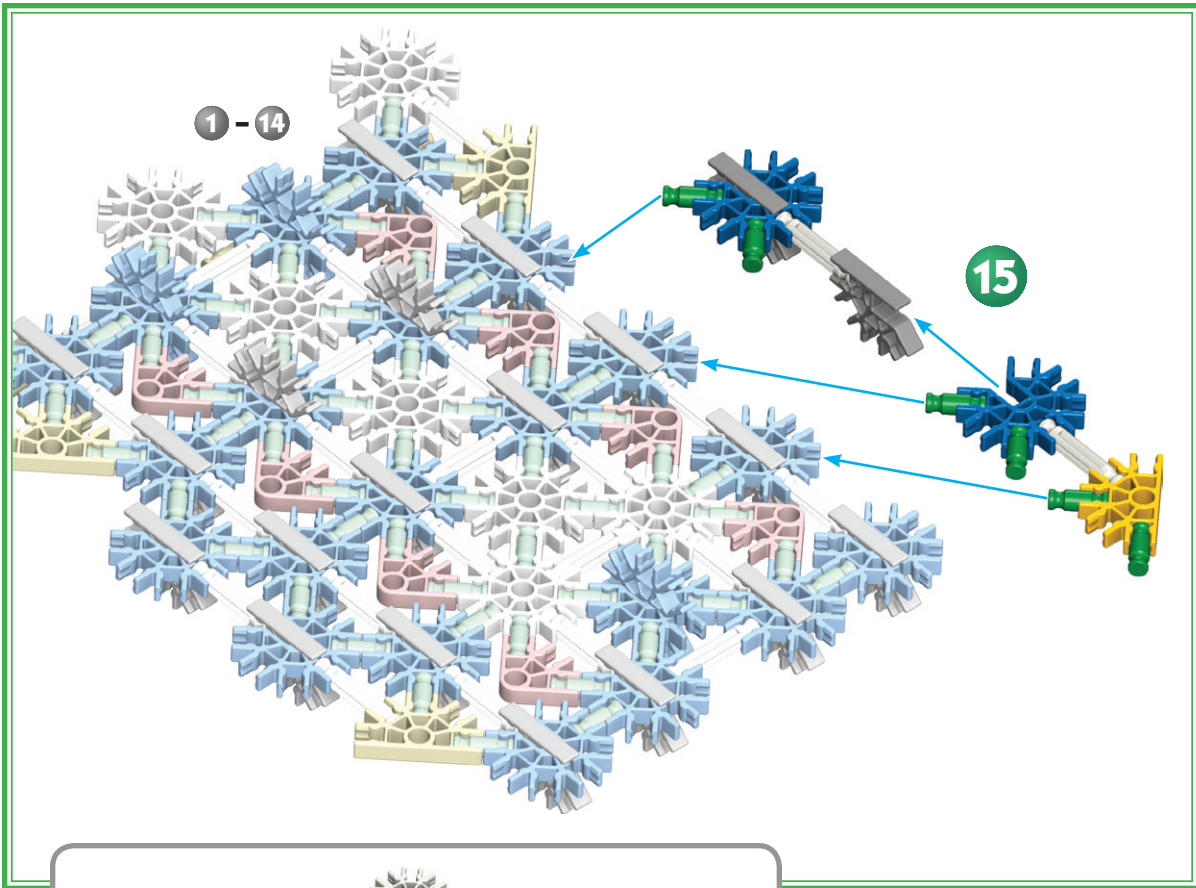

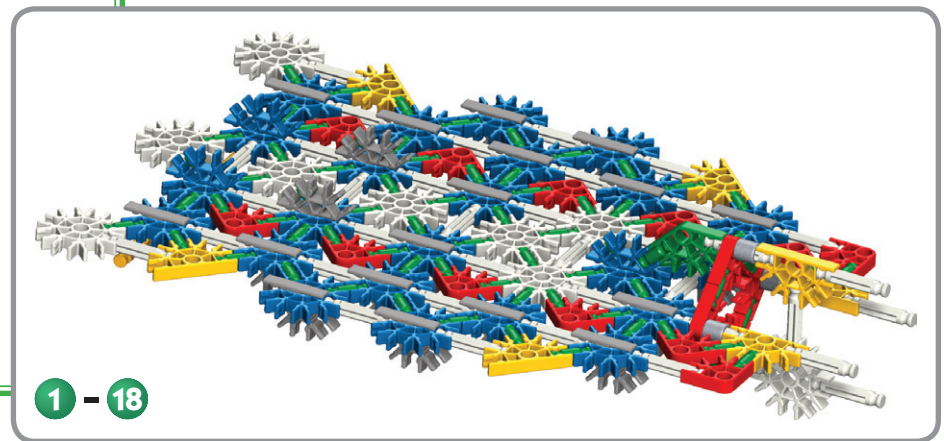
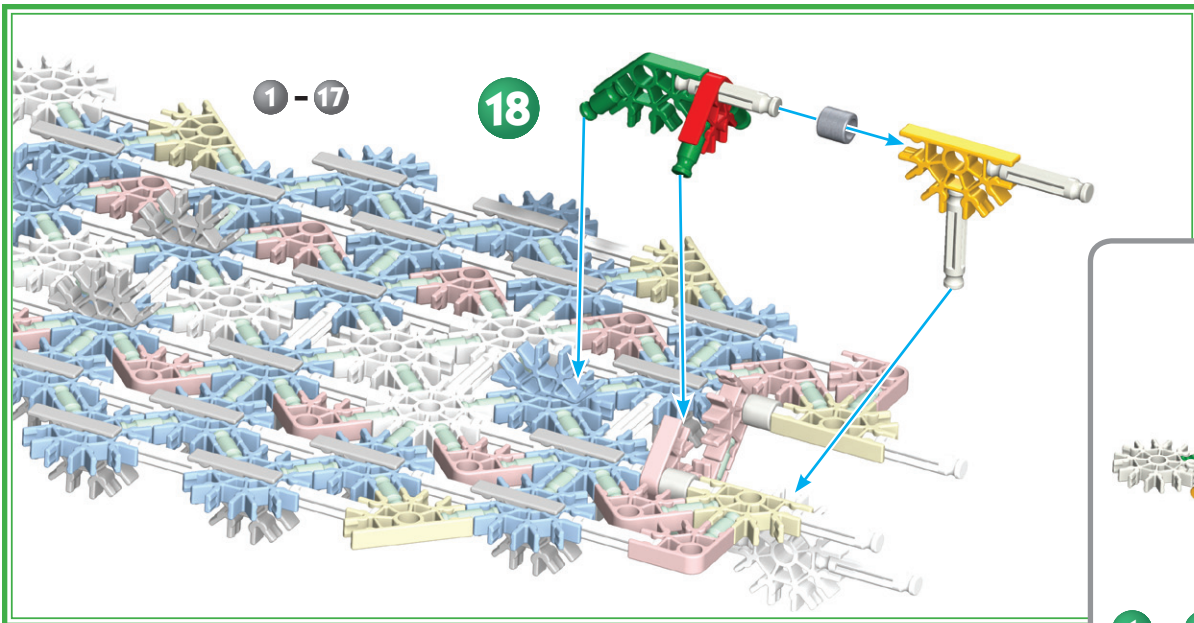
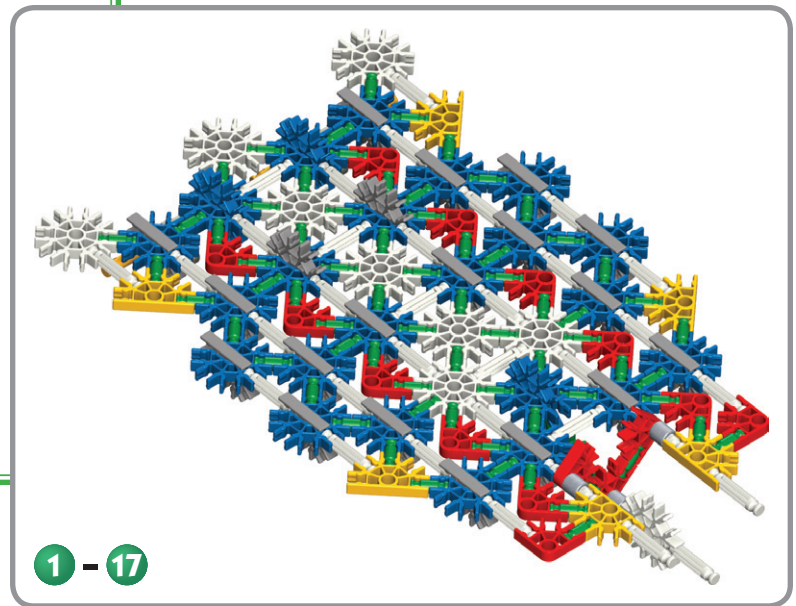
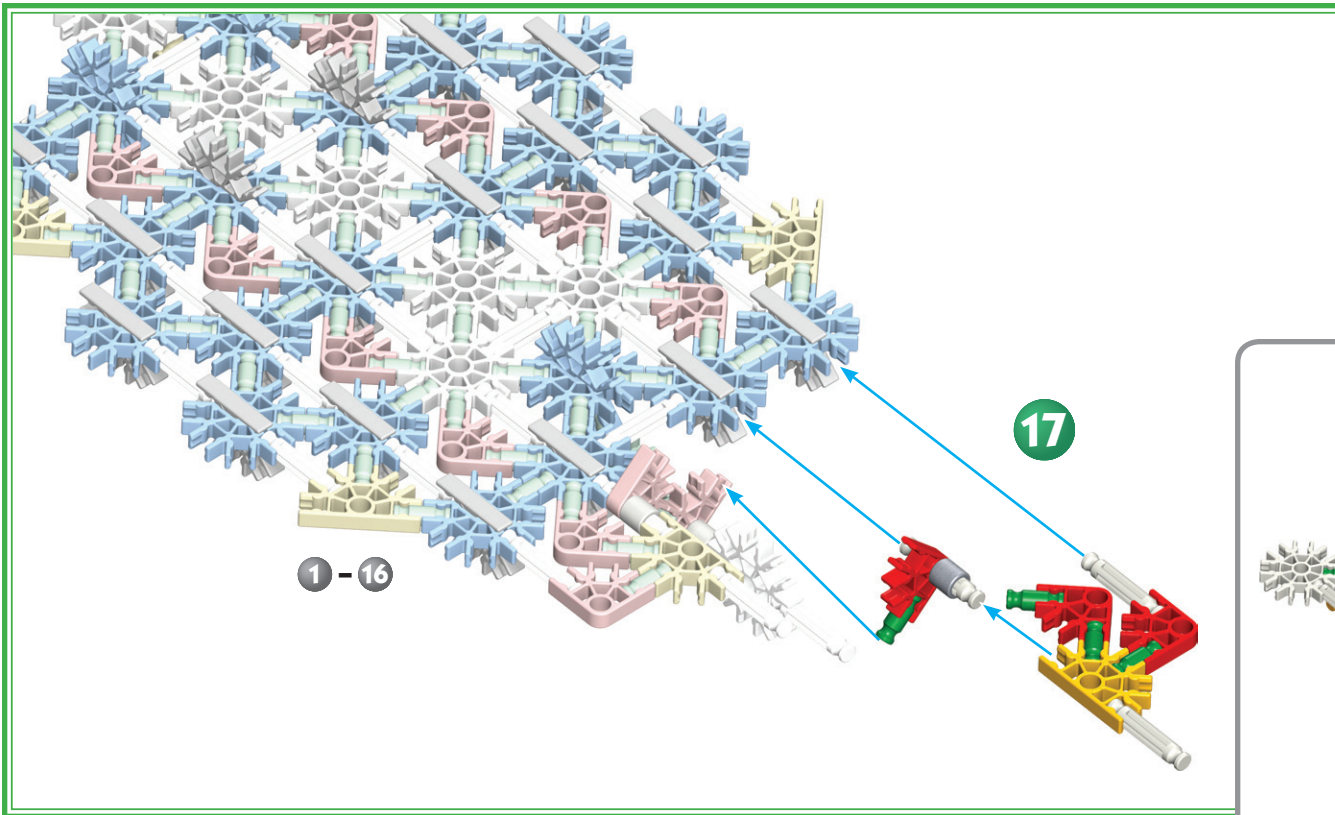

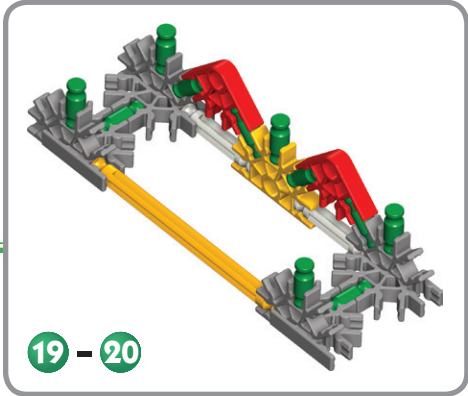
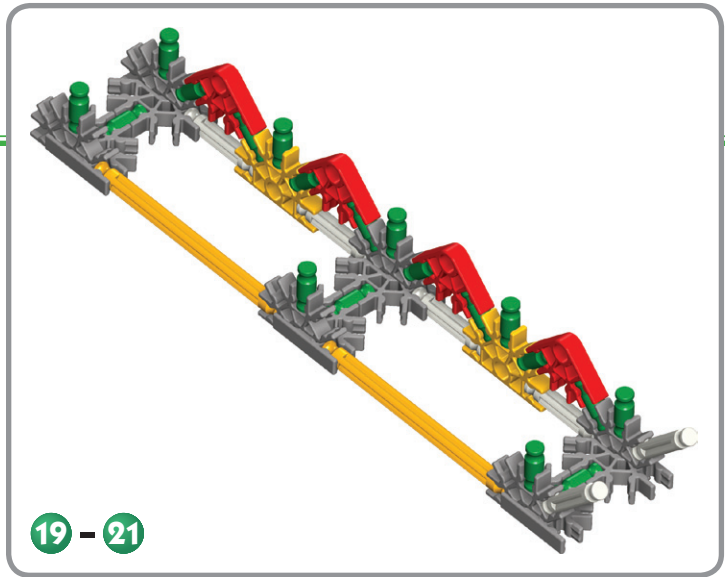
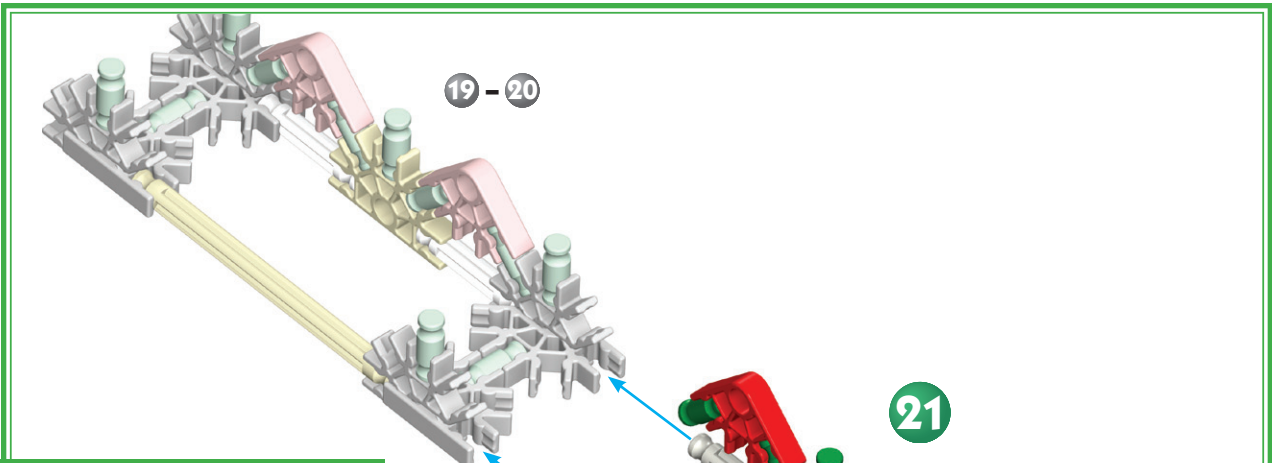
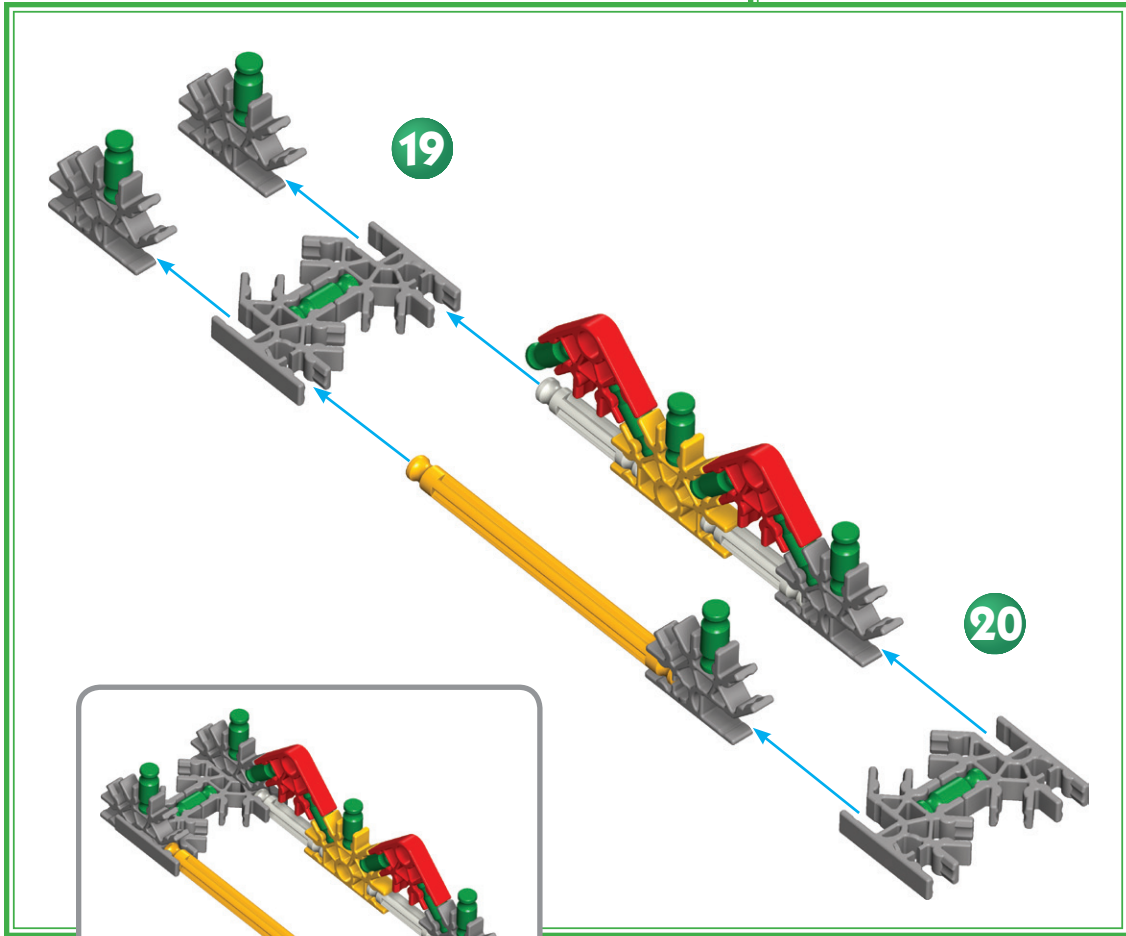

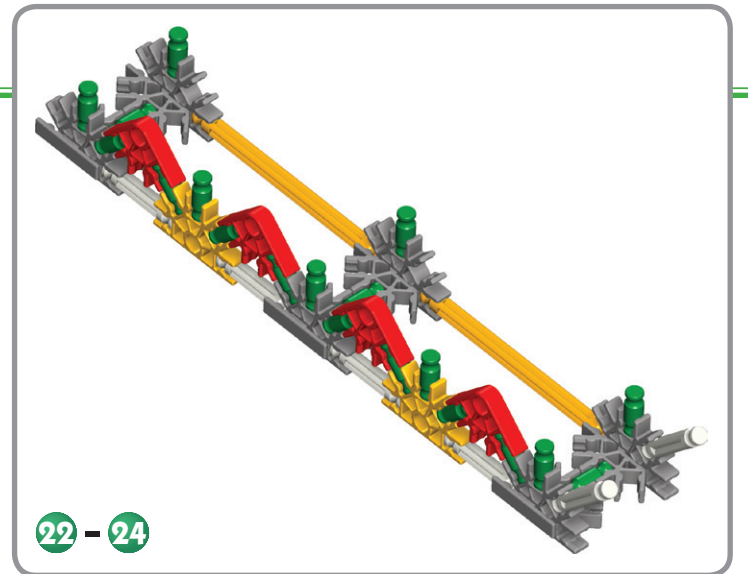
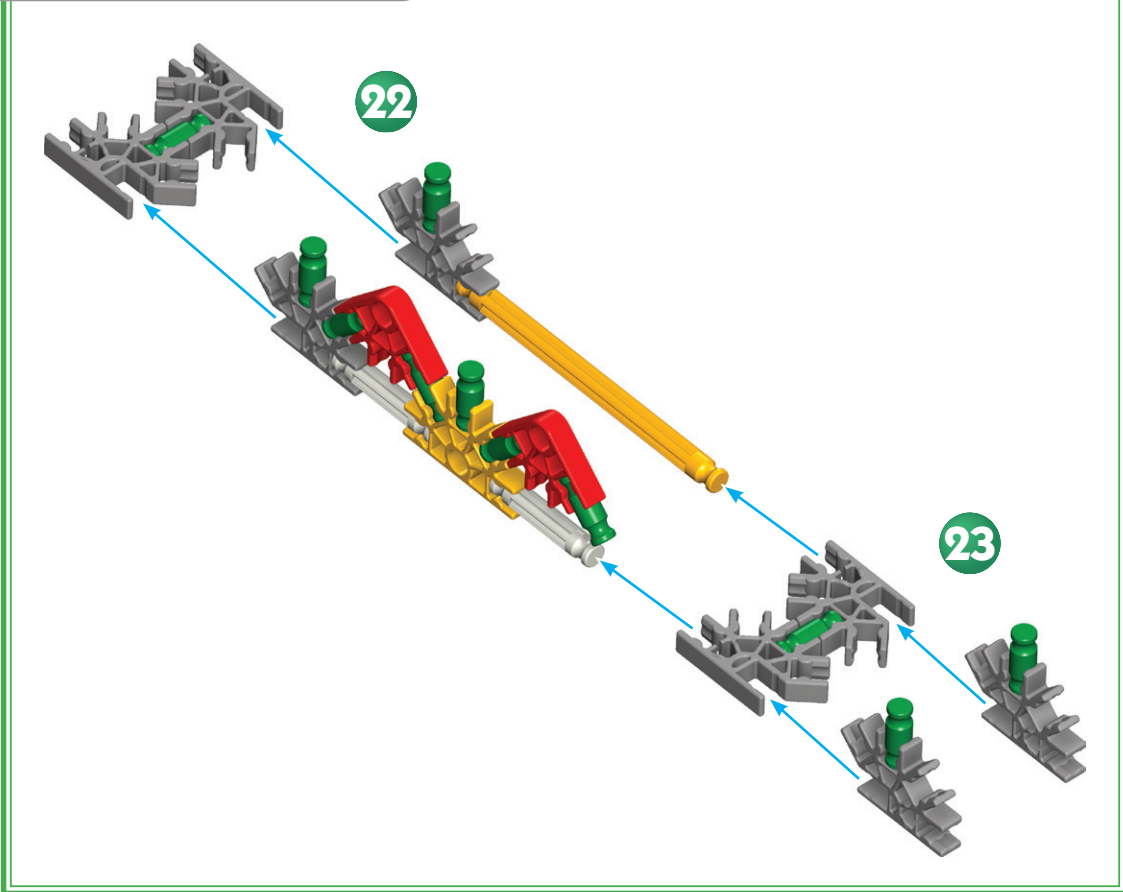
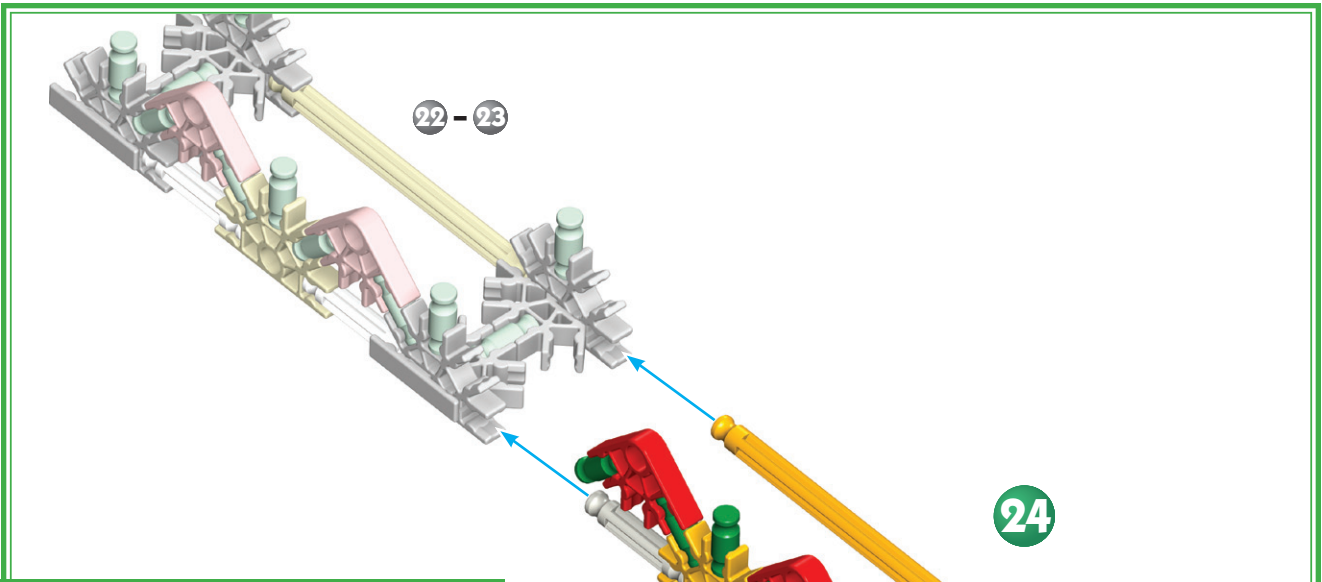
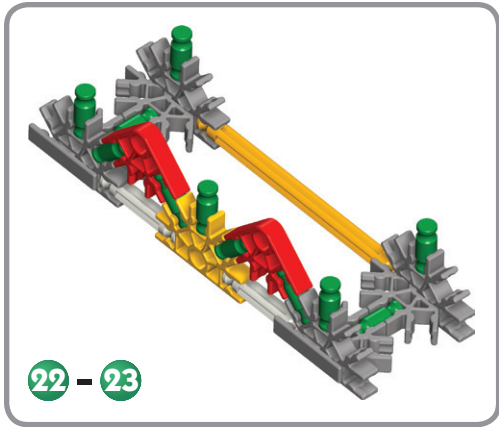

Turn Model Over

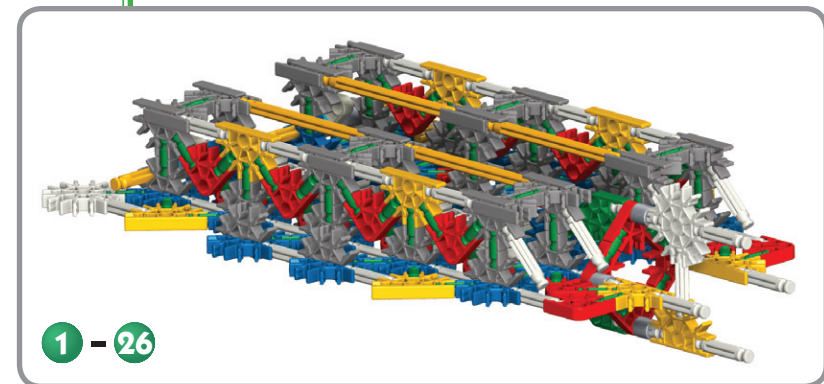
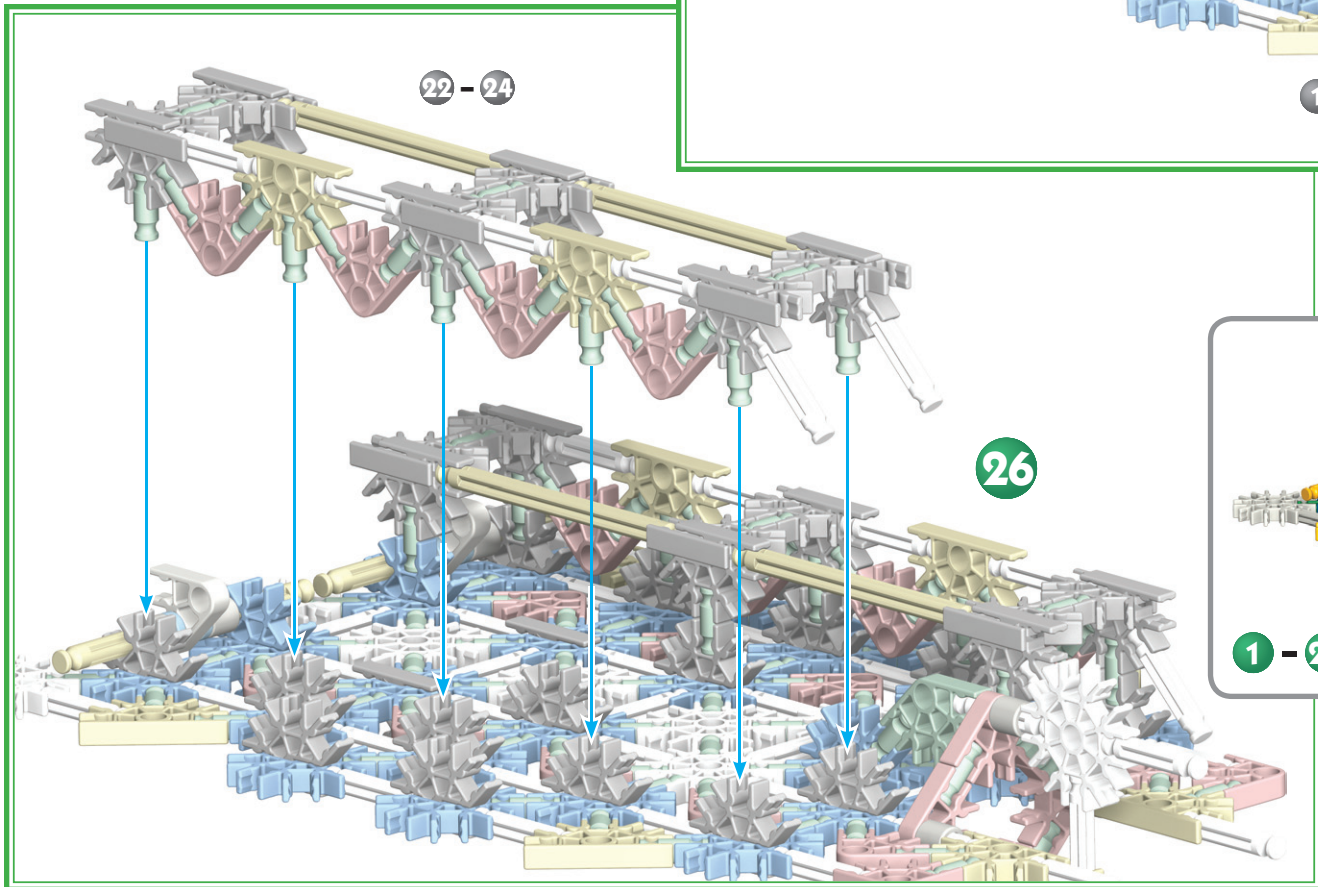
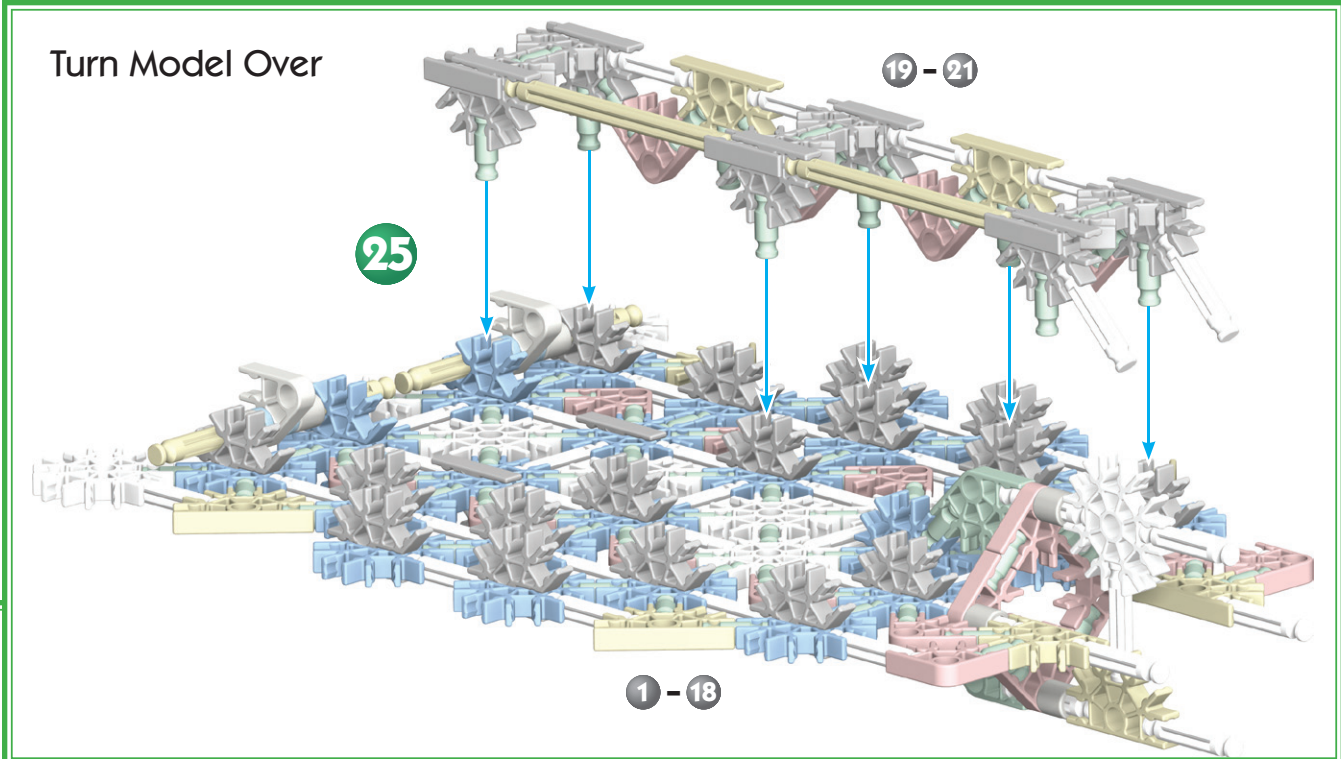

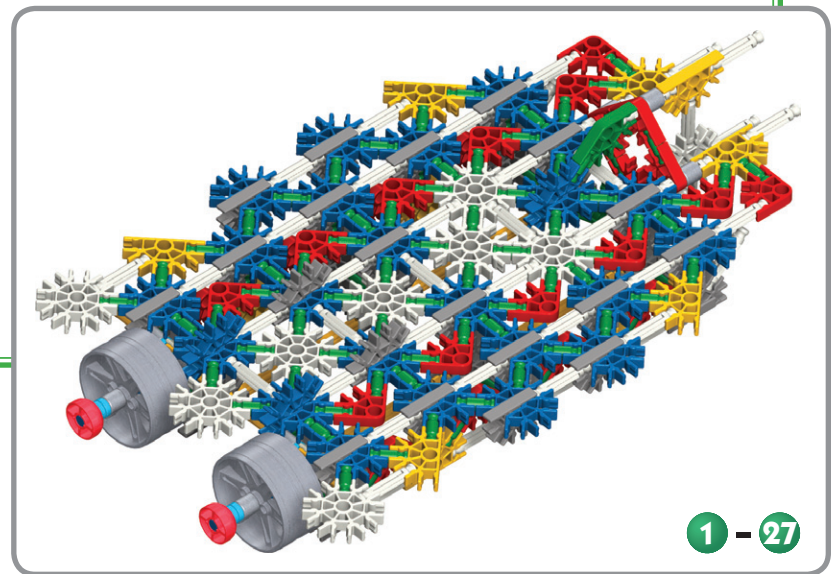
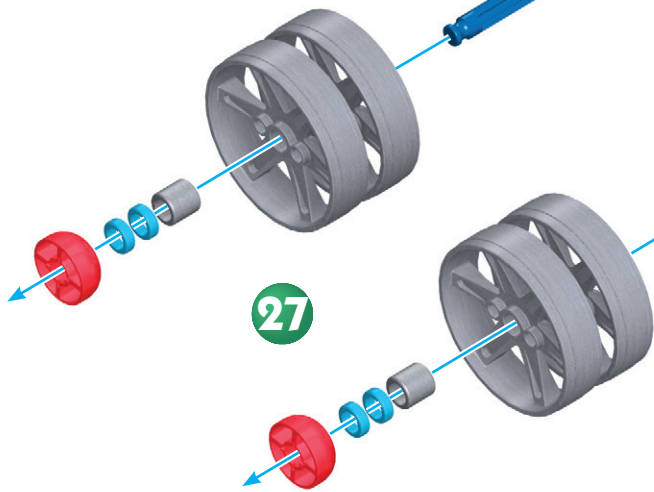
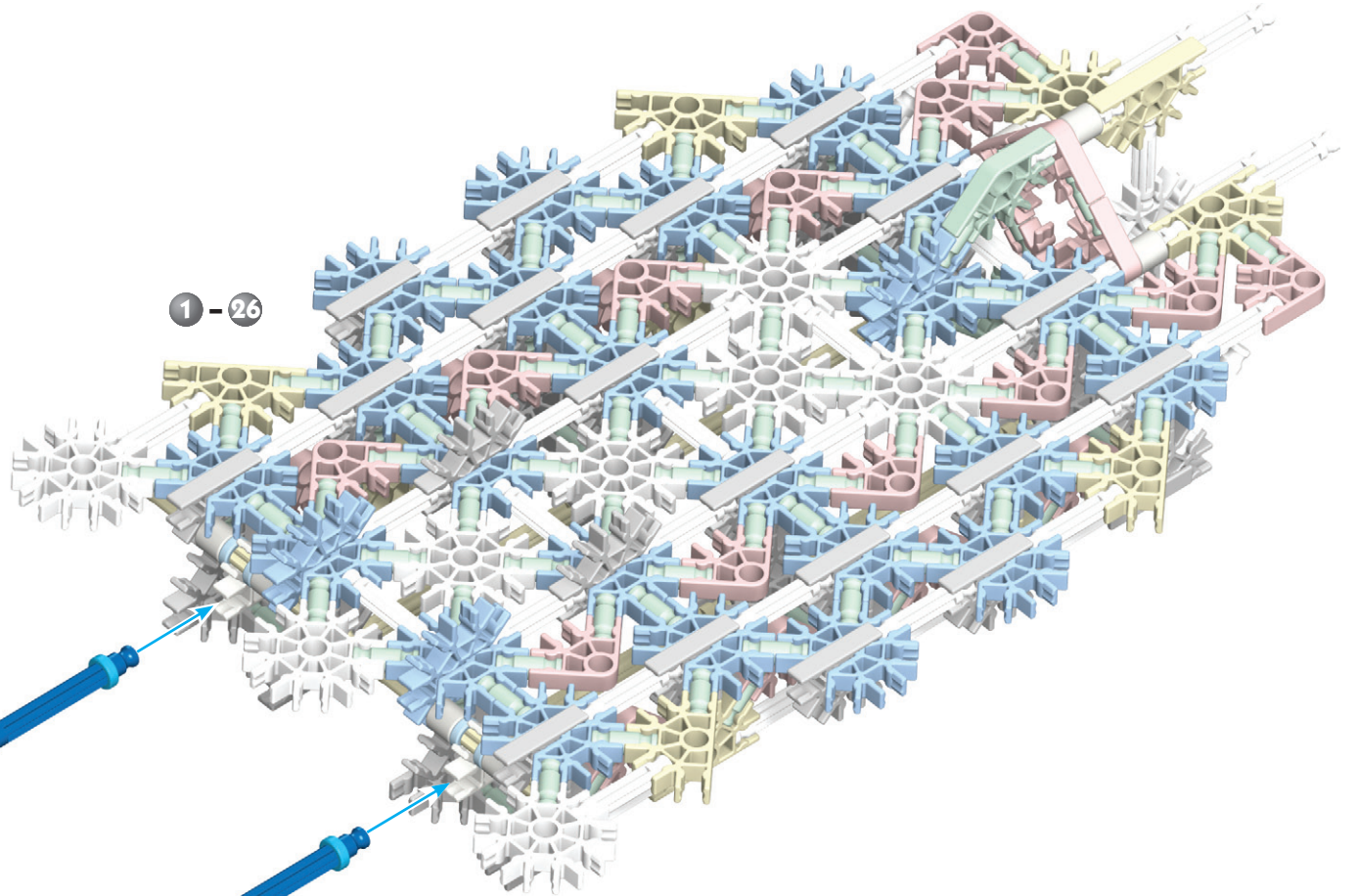

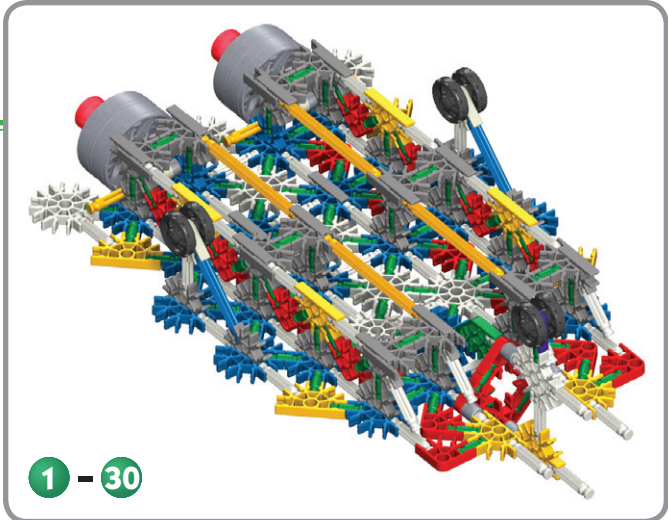
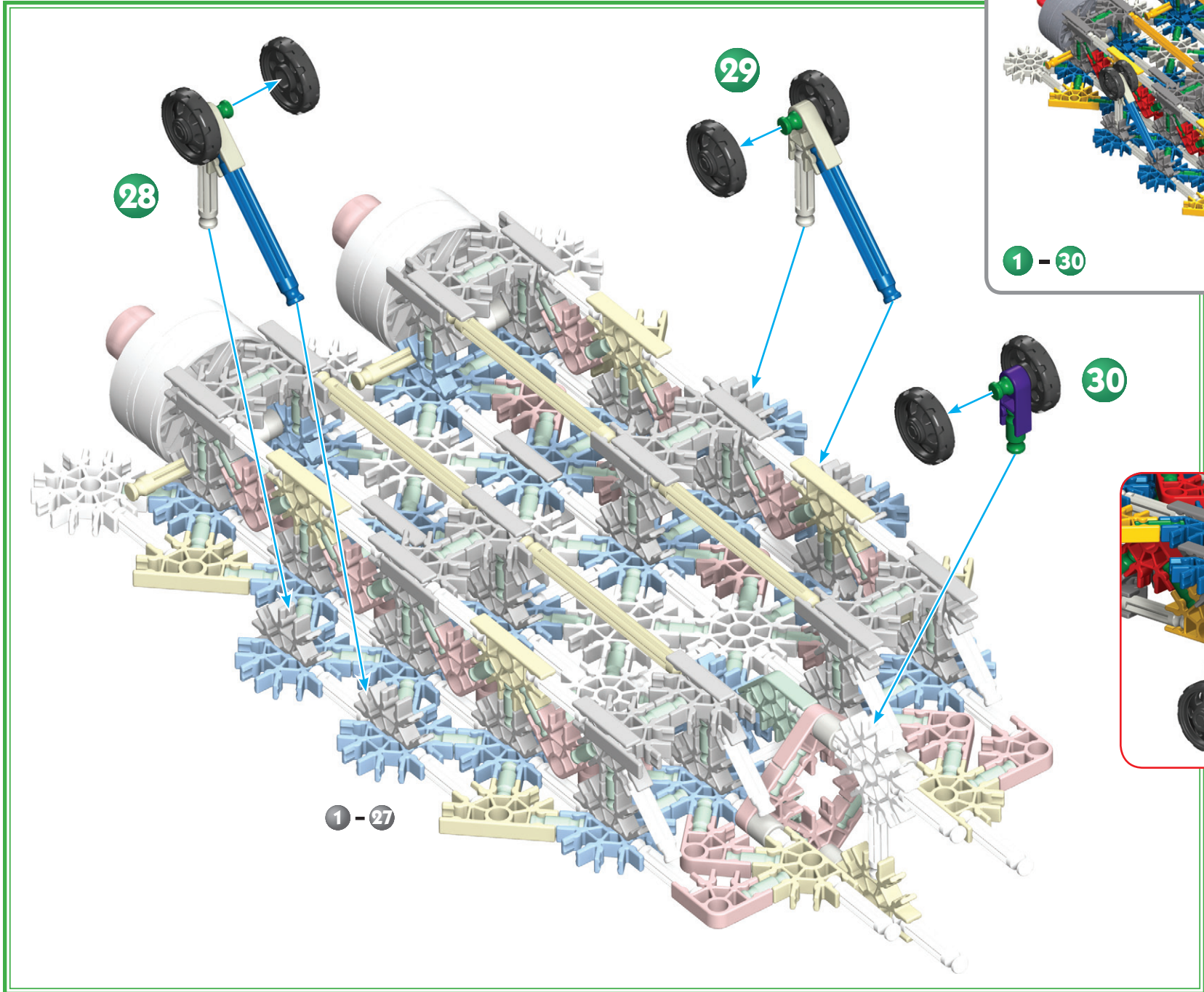

30

