

K'NEX[®]

Building Worlds Kids Love[®]

800

PIECE
SUPER VALUE SET
ENSEMBLE DE QUALITÉ
SUPÉRIEURE DE 800
PIÈCES

50
Building Ideas
Idées de
Construction

7+

12950



**MOTOR
MOTEUR**

(EN) CONTENTS

Sailboat	6
Rocket	7
Stegosaurus	8
Igloo	9
Suspension bridge.....	10
Ball Toss Game	11
Alarm Clock	14
Carousel	16
Tennis Racquet	21
Tractor	24
UFO	28
Windmill	29
Birthday Cake	35
Locomotive	39
Play-Set	41

IMPORTANT STUFF FOR PARENTS AND KIDS

Keep these instructions in a handy location. They contain important safety information.

Read all warnings and instructions before you start to build and operate the model.

⚠ WARNING: CHOKING HAZARD - Toy contains a small ball and small parts. Not for children under 3 years.

CAUTION: Keep hands, face, hair and clothing away from all moving parts.

- Share the K'NEX experience with your child and make building with K'NEX a family fun adventure.
- Take your time to enjoy the building process. Don't rush.
- While you're building make sure to hold the model in the same direction as the pictures show in the instructions.
- Product and colors may vary.

Go to [knex.com](https://www.knex.com) to find any instruction updates.

(FR) CONTENTS

Voilier	6
Fusée	7
Stégosaure	8
Igloo	9
Pont Suspendu	10
Lancer de Balle	11
Réveil	14
Carrousel	16
Raquette de Tennis	21
Tracteur	24
OVNI	28
Moulin à Vent	29
Gâteau D'Anniversaire	35
Locomotive	39
Jeu-Ensemble	41

INFORMATIONS IMPORTANTES POUR LES PARENTS ET LES ENFANTS

Garder ces instructions à portée de la main. Elles comportent d'importantes informations de sécurité.

Lire tous les avertissements et les instructions avant de commencer le montage et l'exploitation du modèle.

⚠ AVERTISSEMENT : RISQUE D'ÉTOUFFEMENT. Jouet contient une petite boule et pièces de petite taille. Neconvient pas aux enfants de moins de 3 ans.

ATTENTION : Garder les cheveux, les doigts, la figure et les vêtements à l'écart de toutes les pièces mobiles.

- Partager l'expérience K'NEX avec votre enfant et faire du montage K'NEX un agréable projet de famille.
- Prendre son temps lors du montage. Ne pas se presser.
- Essayer de situer votre modèle dans le même sens que les instructions durant le montage.
- Le produit et les couleurs peuvent varier.

Allez [knex.com](https://www.knex.com) à pour les mises à jour d'instruction.

Battery Information

CAUTION: To Avoid Battery Leakage

- Be sure to insert the batteries correctly and always follow the toy and battery manufacturers' instructions.
- Do not mix old and new batteries or alkaline, standard (carbon-zinc) or rechargeable (nickel-cadmium) batteries. Only batteries of the same or equivalent type recommended should be used.
- Always remove weak or dead batteries from the product; do not short-circuit supply terminals.
- Insert batteries with correct polarity (+/-) as shown.

Informations Sur Les Piles

ATTENTION : Pour éviter la fuite des piles

- S'assurer d'installer les piles correctement et de suivre toujours les directives des fabricants du jouet et des piles.
- Ne pas mélanger des piles neuves avec des piles usées. Ne pas mélanger des piles alcalines avec des piles standard, ou des piles rechargeables (au nickel-cadmium). Il convient d'utiliser uniquement des piles du type recommandé ou d'un type équivalent.
- Retirer toujours les piles faibles ou mortes du produit ; ne pas faire court-circuiter les terminaux.
- Installer les piles en respectant la polarité (+/-) comme l'indique le schéma.

HOW TO INSERT AND REMOVE THE BATTERIES

Use a small Phillips head screwdriver to loosen the screw and open the battery compartment. Insert 2 fresh AA batteries* (LR6) into the compartment with the correct polarity (+/-) as shown here.

* Not included

COMMENT METTRE ET RETIRER DES PILES

Utiliser un petit tournevis Phillips pour desserrer la vis et pour enlever la couverture de batterie. Insérer 2 piles AA (LR6) neuves dans le compartiment à piles* en respectant la polarité (+/-).

* Non fournies



IMPORTANT TIPS

- Alkaline batteries are recommended.
- Rechargeable batteries are not recommended.
- Remove rechargeable batteries from toy before charging; they must be charged only under adult supervision.
- Non-rechargeable batteries must not be recharged.
- Keep components free of dust; do not immerse or use in water.
- Do not dispose of batteries in a fire; they could leak or explode and cause injury.
- Remove all batteries if the toy will not be used for a long period of time.
- Do not put any small rods in any openings of the motor; they will damage the motor and cannot be removed.
- Help the environment by disposing of your product and packaging responsibly. The wheelie bin symbol indicates that the product and batteries must not be disposed of in the domestic waste as they contain substances which can be damaging to the environment and health. Please use designated collection points or recycling facilities when disposing of the item or batteries.

CONSEILS IMPORTANTS

- Les piles alcalines sont recommandées.
- Les piles rechargeables ne sont pas recommandées.
- Retirer les piles rechargeables du jouet avant de les recharger; elles doivent être chargées exclusivement en présence d'un adulte.
- Les piles qui ne sont pas rechargeables ne doivent pas être rechargées.
- Veiller à ce que les éléments restent à l'abri de la poussière ; ne pas les plonger dans l'eau ; ne pas utiliser dans l'eau.
- Ne pas jeter les piles dans le feu ; elles risqueraient de fuir ou d'exploser et d'entraîner des blessures.
- Retirer toutes les piles si le jouet restera inutilisé pendant longtemps.
- Ne mettez pas les petites tiges dans les trous du moteur, elles endommageraient le moteur et il n'est pas possible de les enlever.
- Aidez l'environnement en jetant votre produit et son emballage de manière responsable. Le symbole de la poubelle à roulettes indique qu'il ne faut pas jeter le produit et les piles avec les ordures ménagères car ils contiennent des substances pouvant être nocives à l'environnement et à la santé. Veuillez utiliser les points de collecte de déchets ou les centres de tri désignés lorsque vous jetez l'article ou les piles.



BUILDING BASICS

BASES DE LA CONSTRUCTION

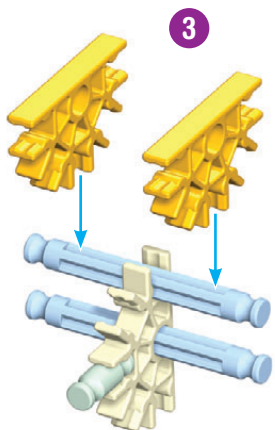
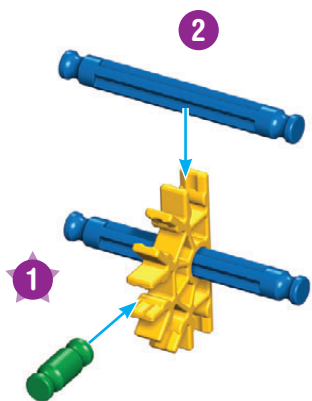

Start Building

To begin your model, find the **1** and follow the numbers. Each piece has its own shape and color. Just look at the pictures, find the pieces in your set that match and then connect them together. Try to face your model in the same direction as the instructions while you build. The arrows show you where the parts connect, but not all connections points have arrows. Faded colors show you this section is already built.

Démarre ta Construction

Pour commencer ton modèle, trouve l'étape numéro **1** et suis les numéros. Chaque pièce a sa propre forme et sa propre couleur. Regarde les illustrations, trouve les pièces qui correspondent à ce que tu vois et assemble-les. Pour t'aider pendant que tu construis, oriente ton modèle dans le même sens que les instructions. Les flèches t'indiquent où les pièces s'assemblent, mais les points de raccordement n'ont pas tous des flèches. Les pièces de couleur délavée sont celles que tu as déjà assemblées.

Connectors

There are blue and gray connectors with special long slots. They slide together as you see in the pictures. Push these parts together until you hear a "click".

Connecteurs

Tu peux assembler ces connecteurs tout à fait uniques en les faisant glisser l'un avec l'autre. Pousse fort jusqu'à ce que tu entendes un « clic ».

Spacers

There are places in your model where you need to add blue and silver spacers. Be sure to use the right color and count them carefully.

Espaceurs

Il y a des endroits sur ton modèle où tu auras besoin de te servir d'espaceurs. Assure-toi d'utiliser la bonne couleur et le nombre d'espaceurs indiqué sur les instructions.

Gears

Note the position of the gears and the direction of the gears' teeth. Make sure the teeth mesh together.

Engrenages

Note la position des engrenages et le sens des dents des engrenages. Assure-toi que les dents des engrenages s'engrènent comme il faut les unes dans les autres.

Flexi-rods

A flexi-rod is a rod that you bend to make curves. It will be easier to attach to your model if you bend it back and forth a few times first.

Tiges Flexibles

Un tige flexible est une tige que tu peux courber pour faire des courbes. Elle pourra être attachée plus aisément à ton modèle si tu la plies en avant et en arrière plusieurs fois.

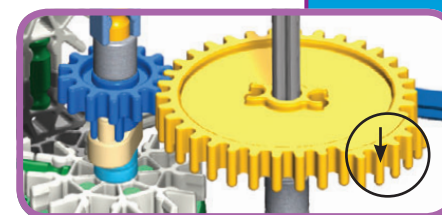
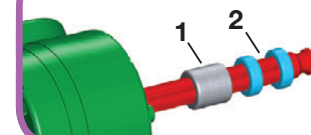
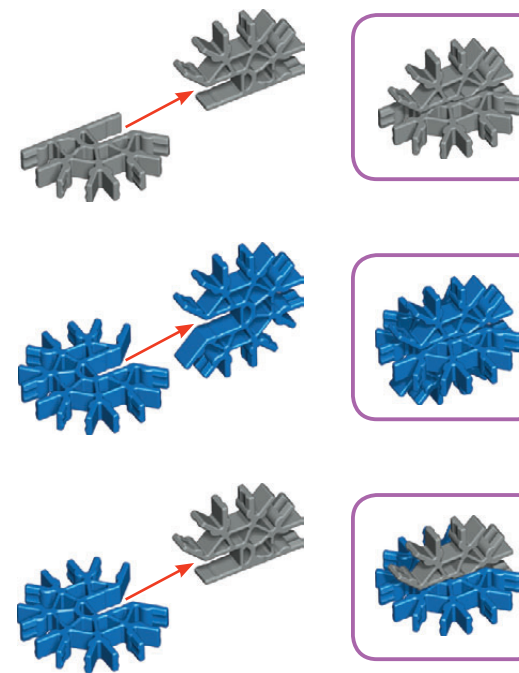

Parts List

Before you start building, be sure to compare the parts in your set with the parts list here. If anything is missing, call or write to us using the information on the back cover. We are here to help you!

Liste des Pièces

Avant de commencer à construire, assure-toi de comparer les pièces dans ta boîte à la liste de pièces fournie ici. S'il manque quelque chose, téléphone-nous ou écris-nous en te servant des informations figurant au verso de la notice. Nous sommes là pour t'aider !



**Sailboat
Voilier**

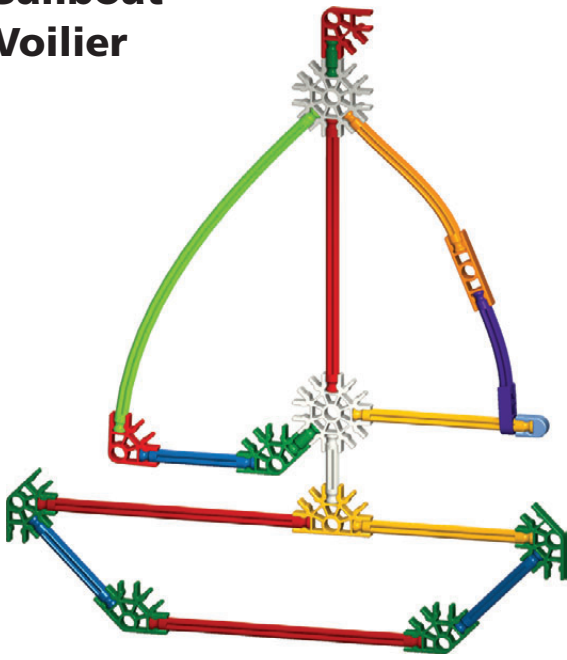

1

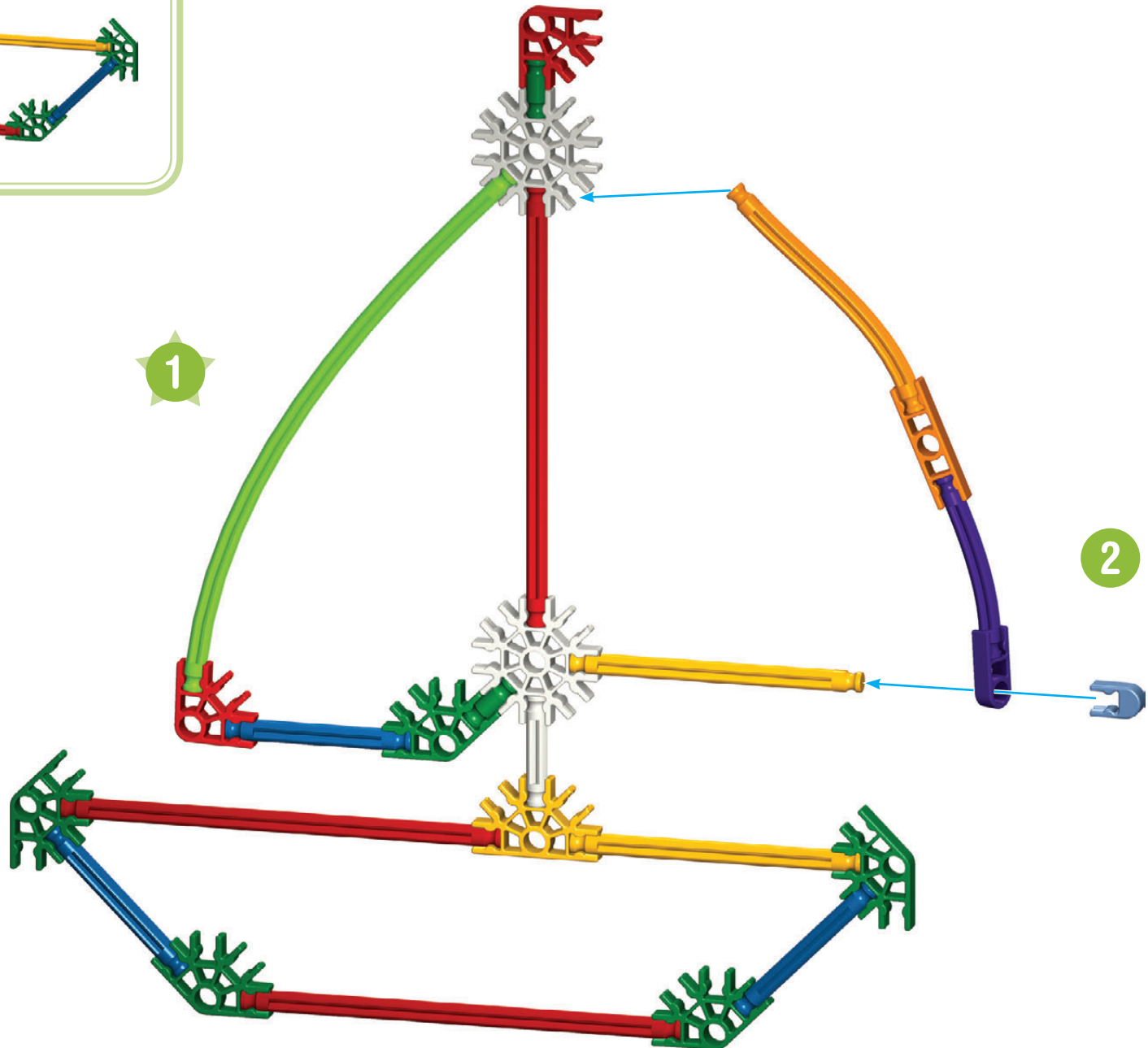

2

1

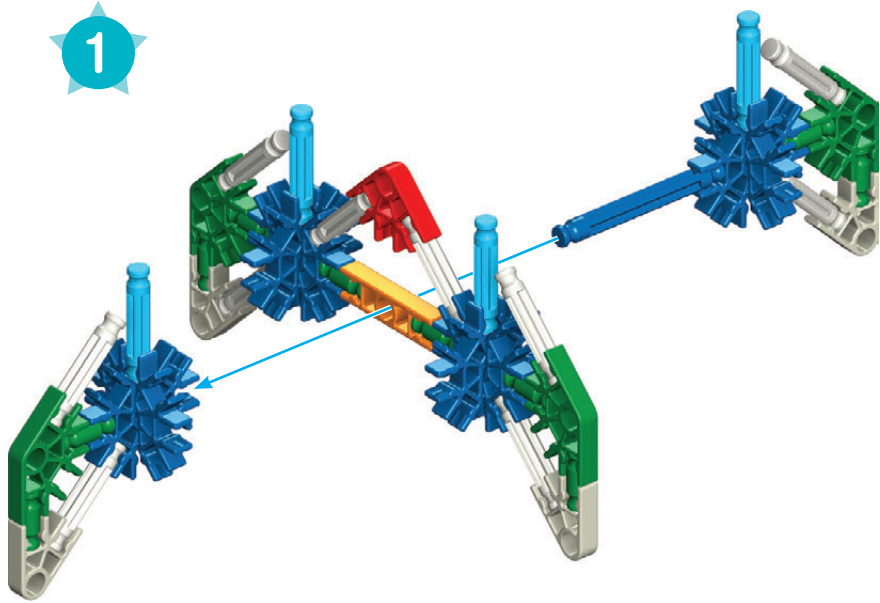

2

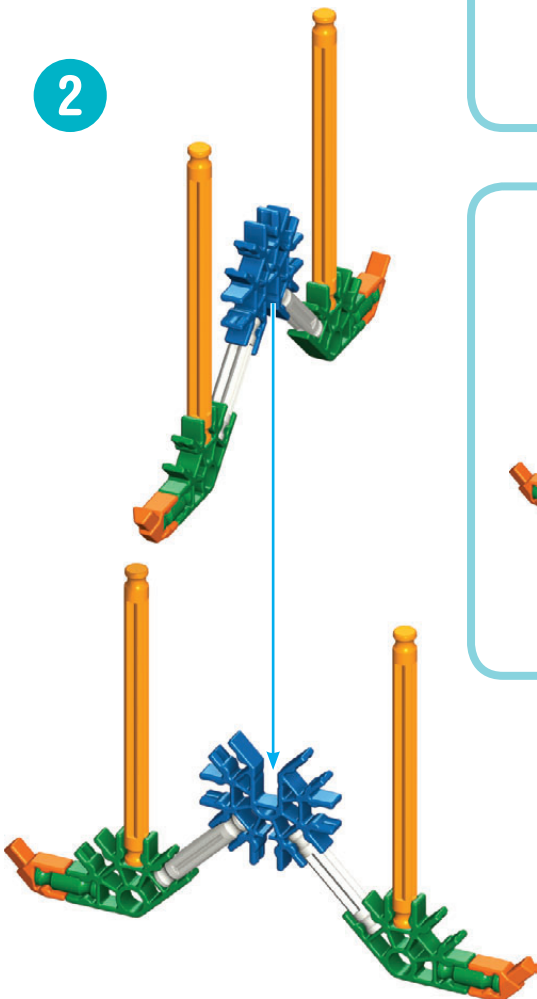

1

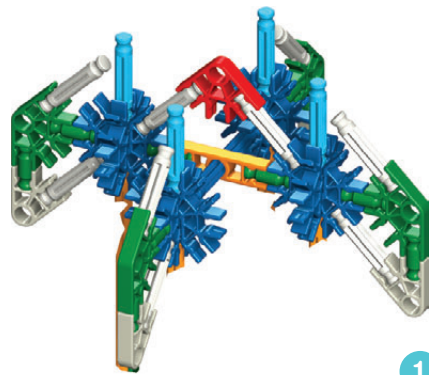

2



3

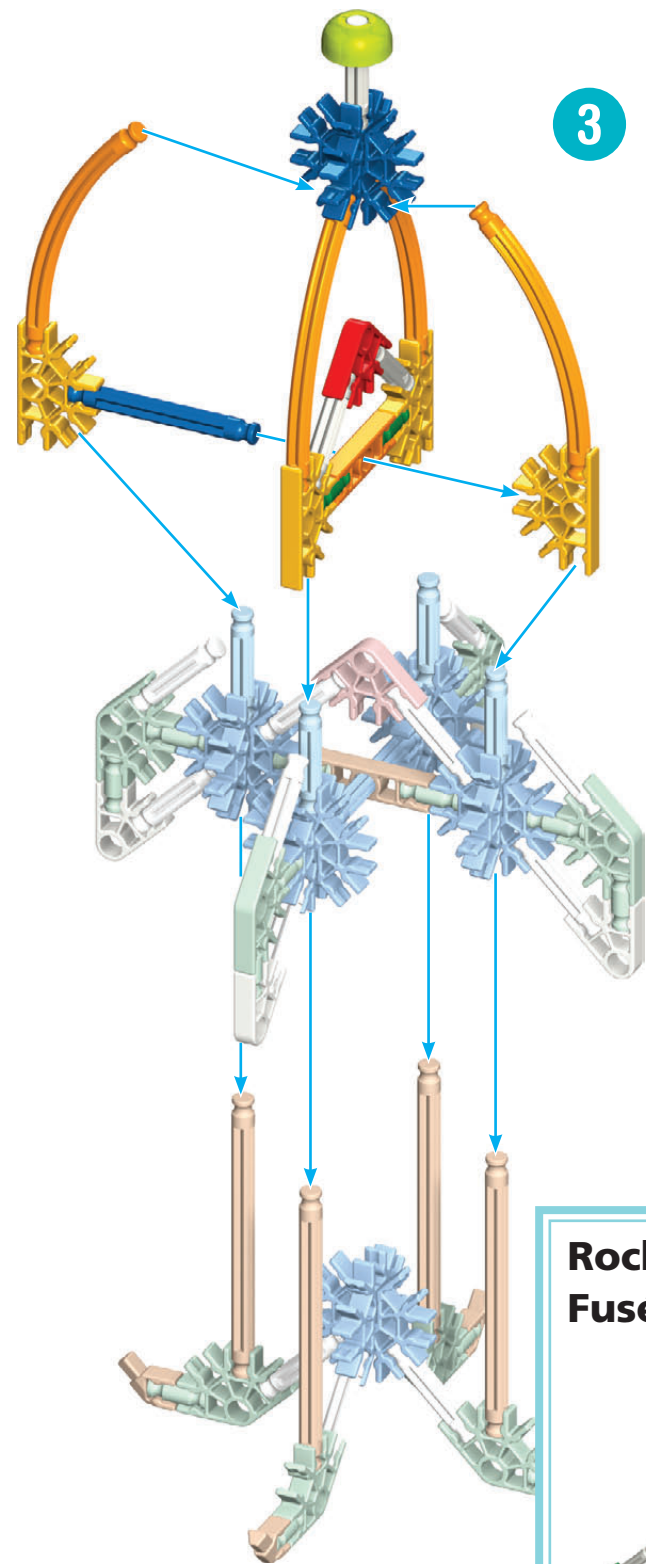

Rocket
Fusée



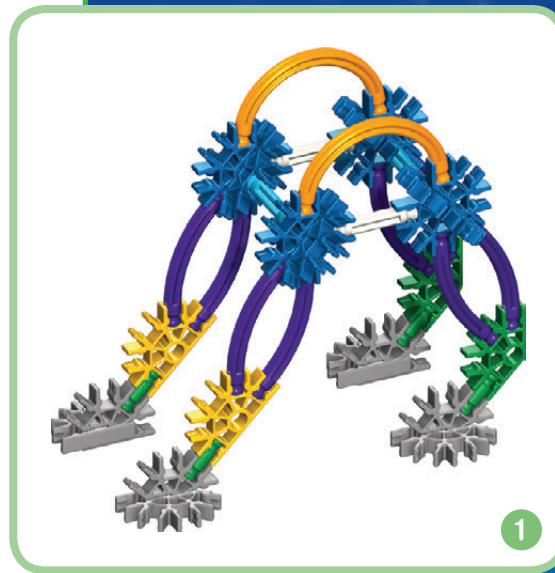
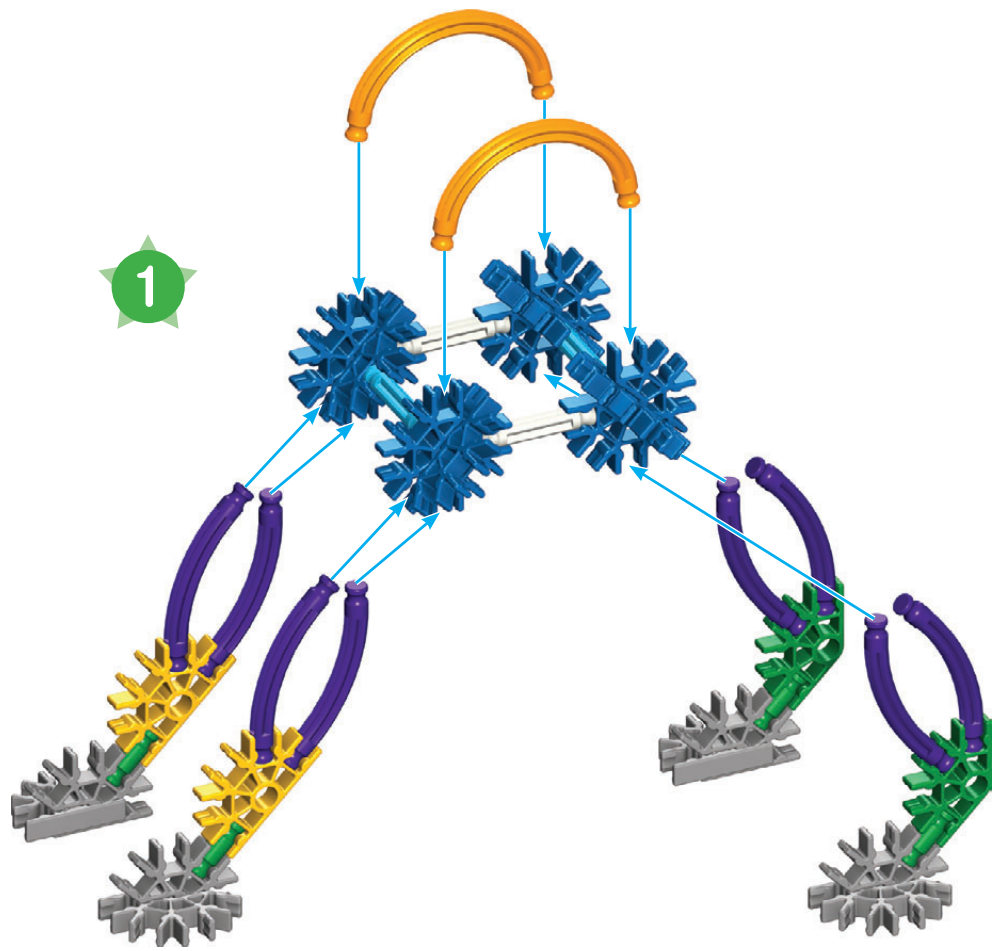

**Stegosaurus
Stégosaure**

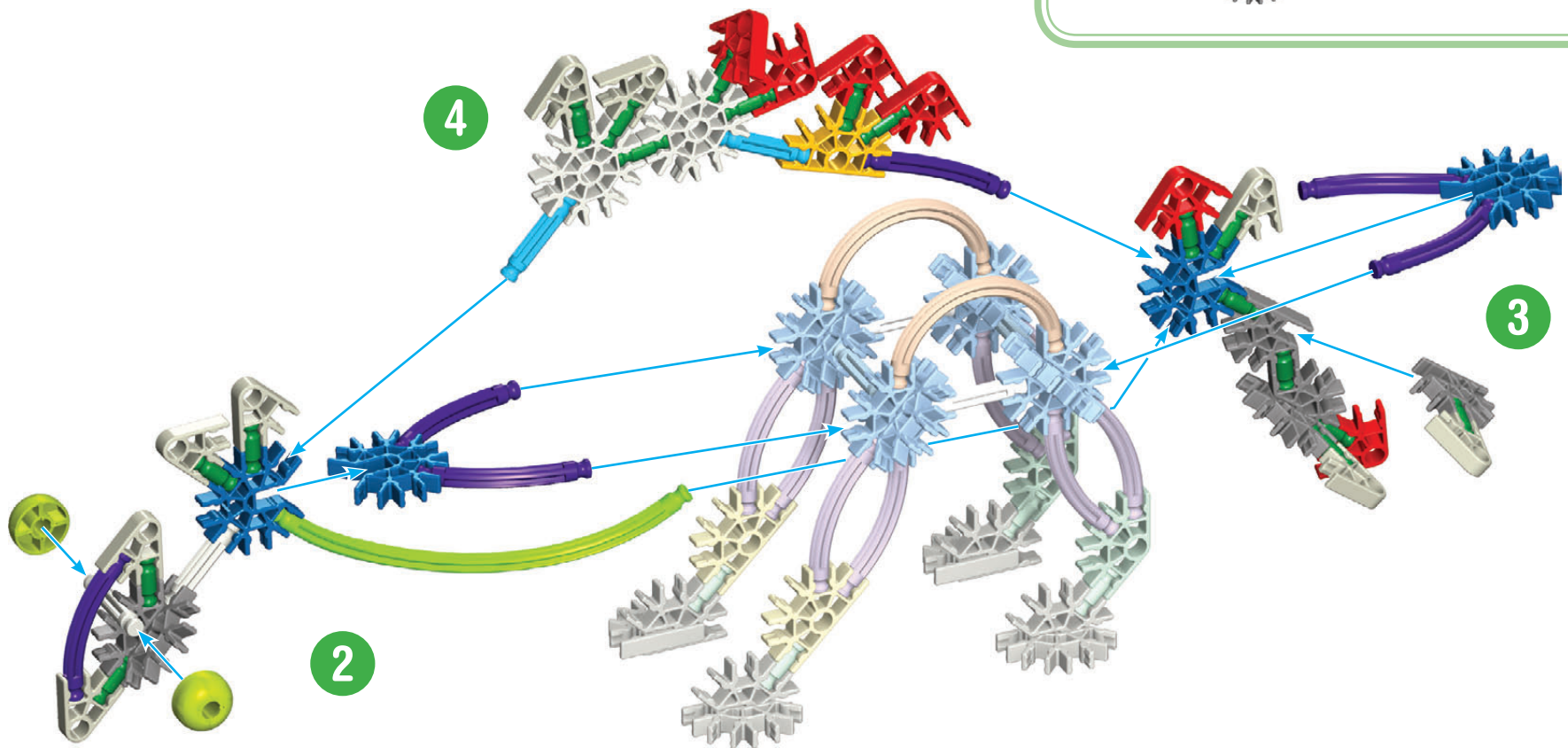
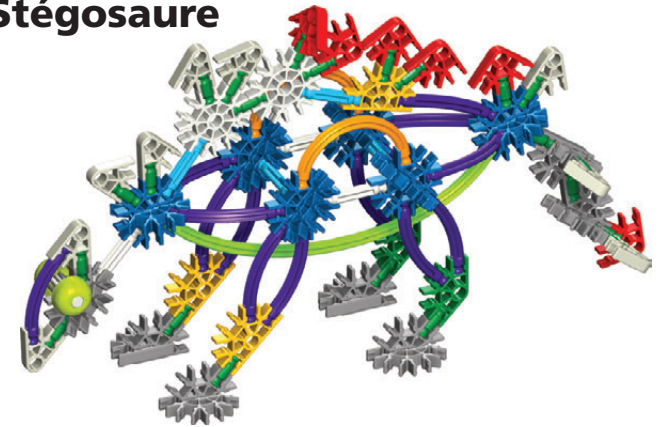

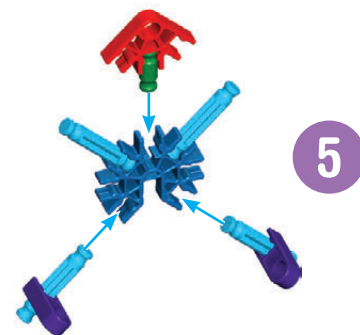
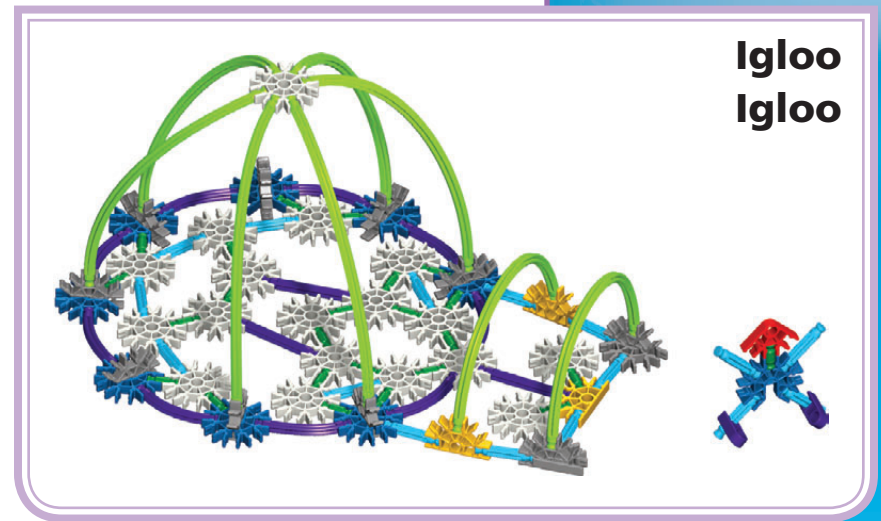
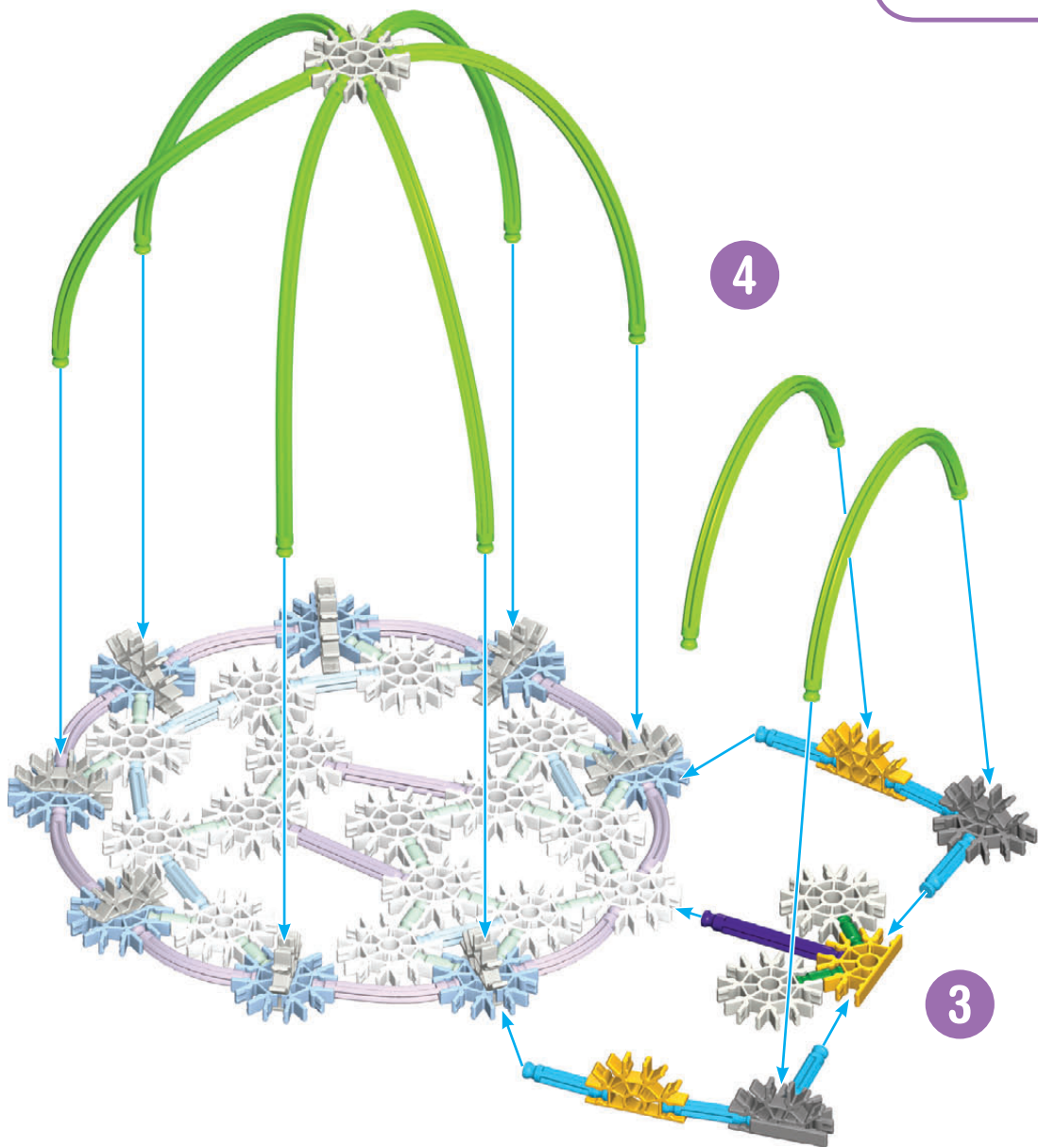
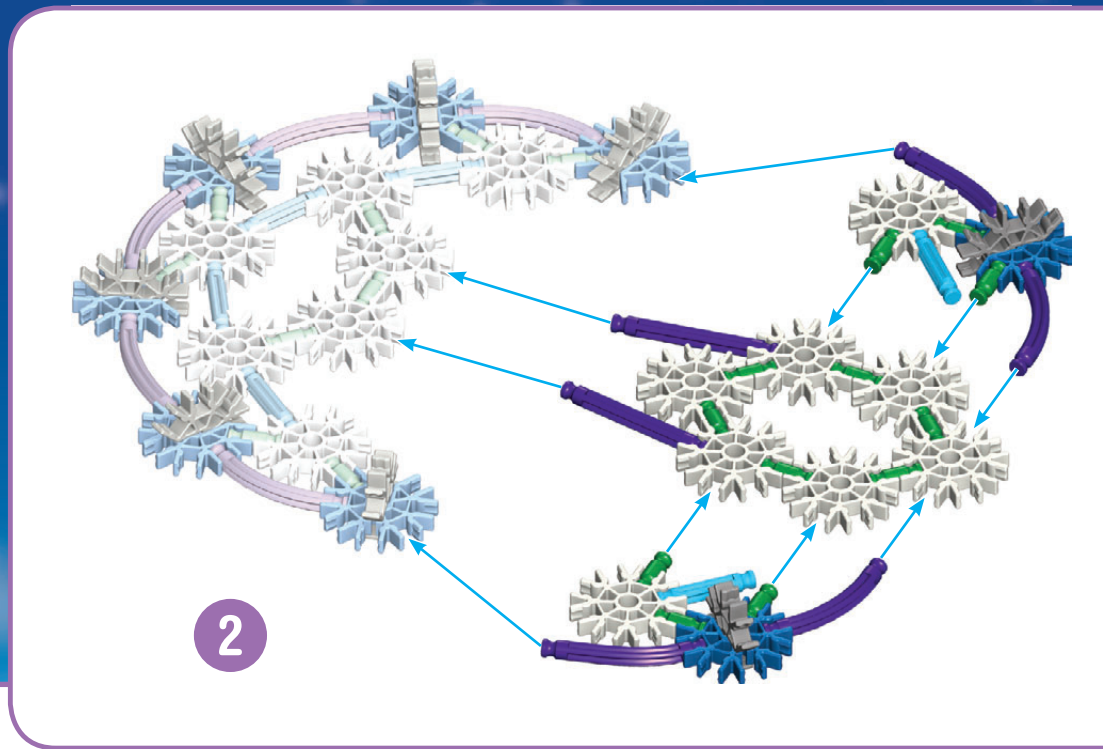
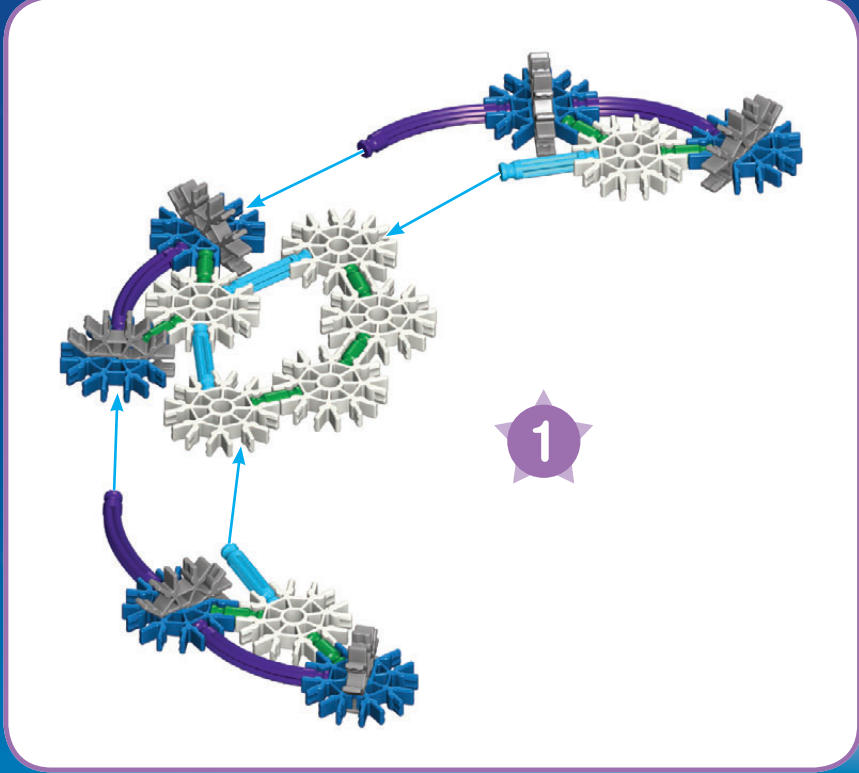

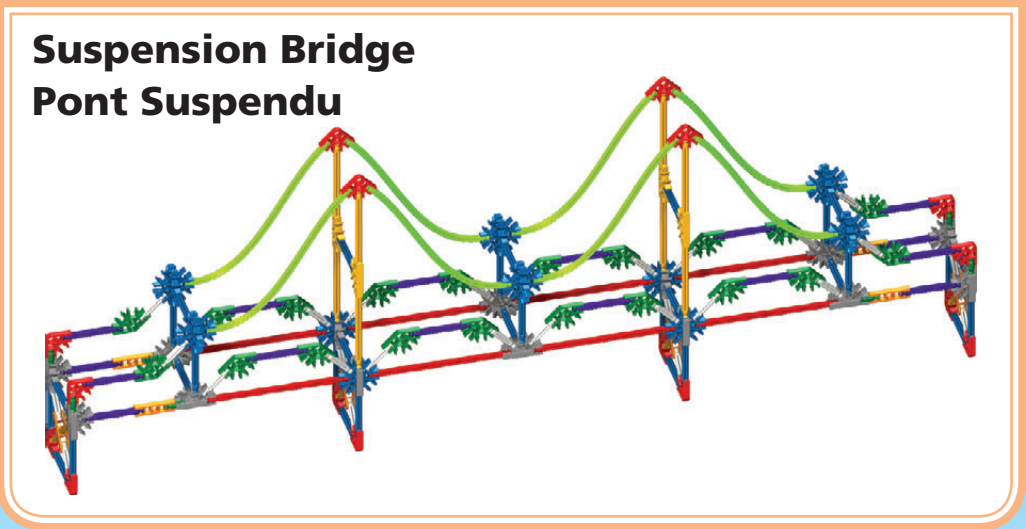
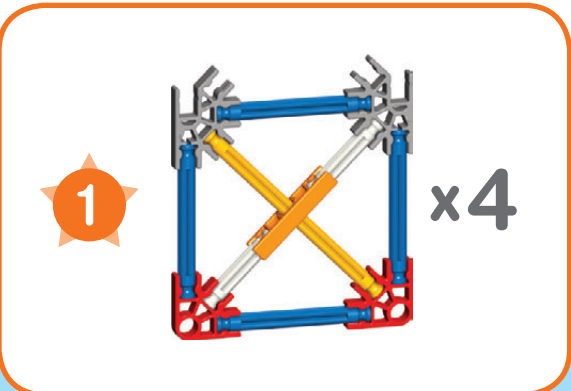
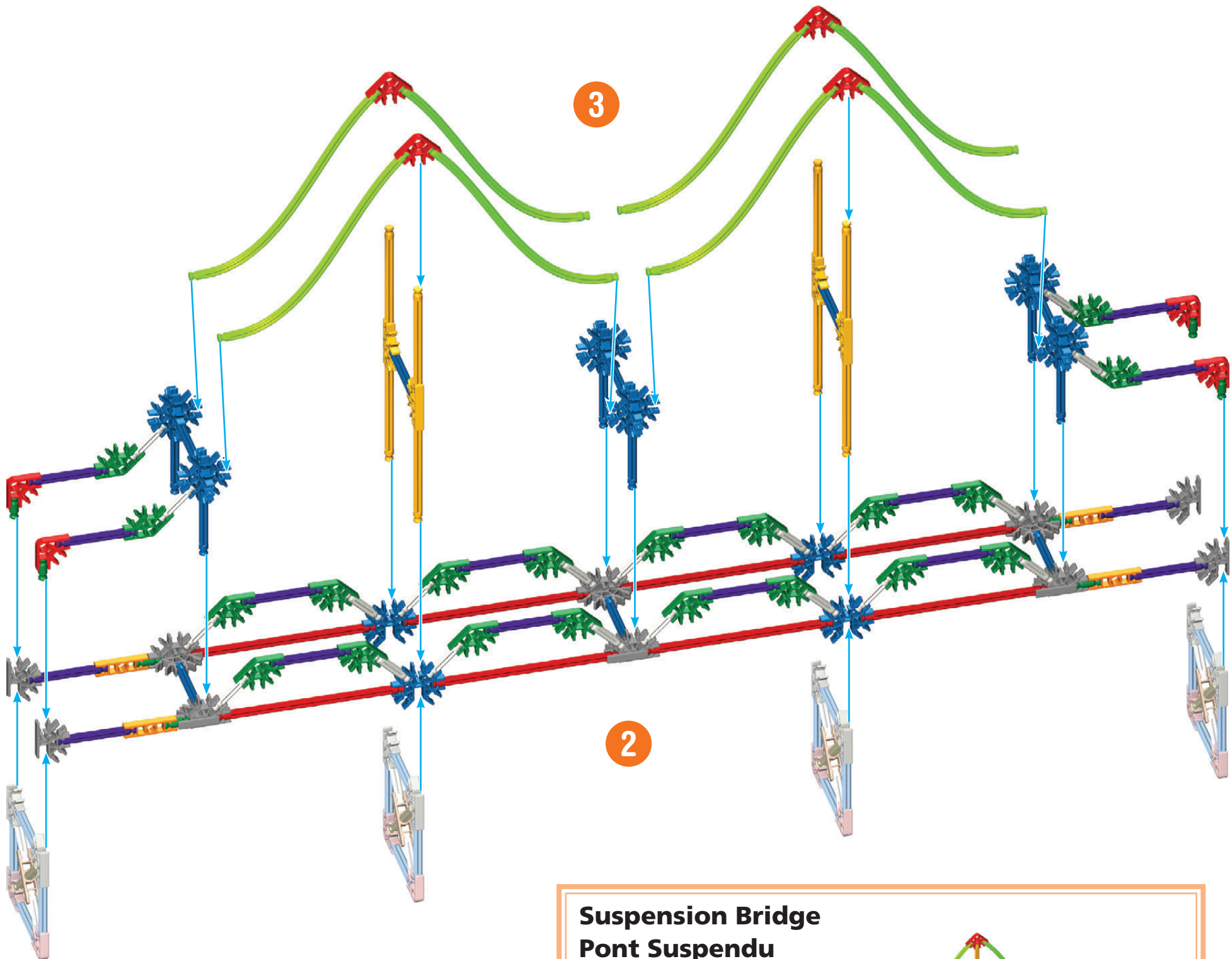

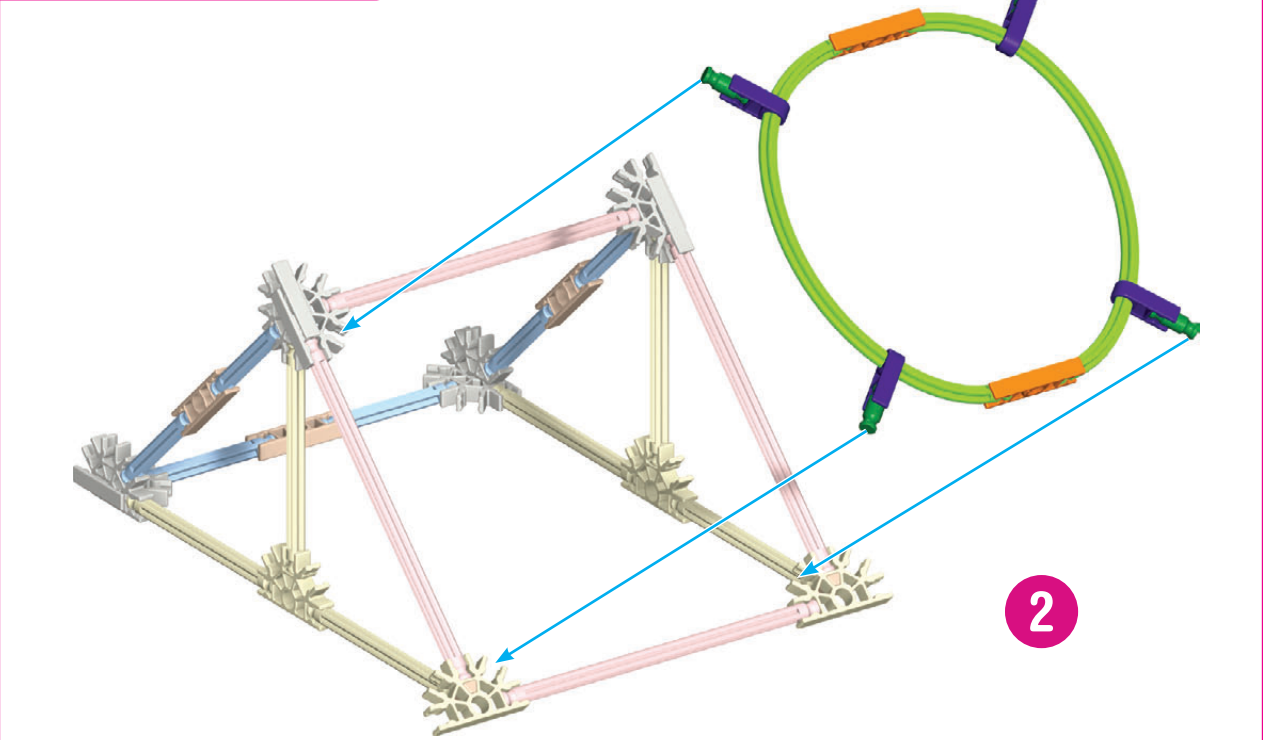
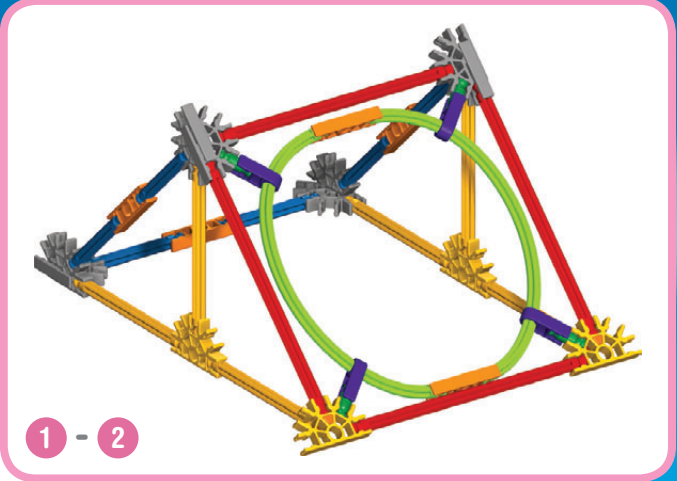
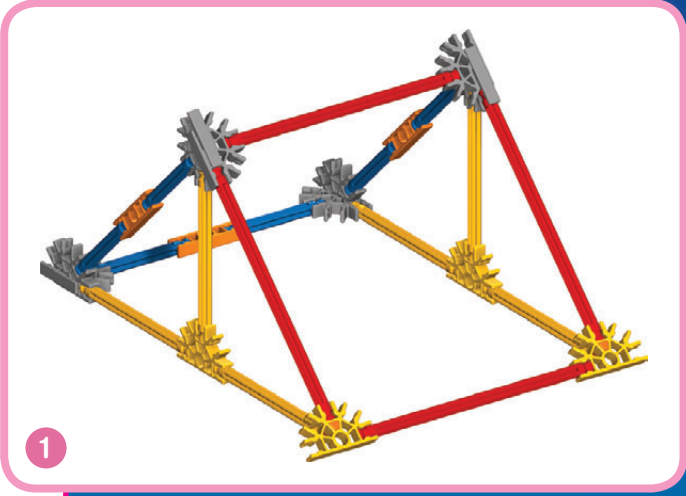
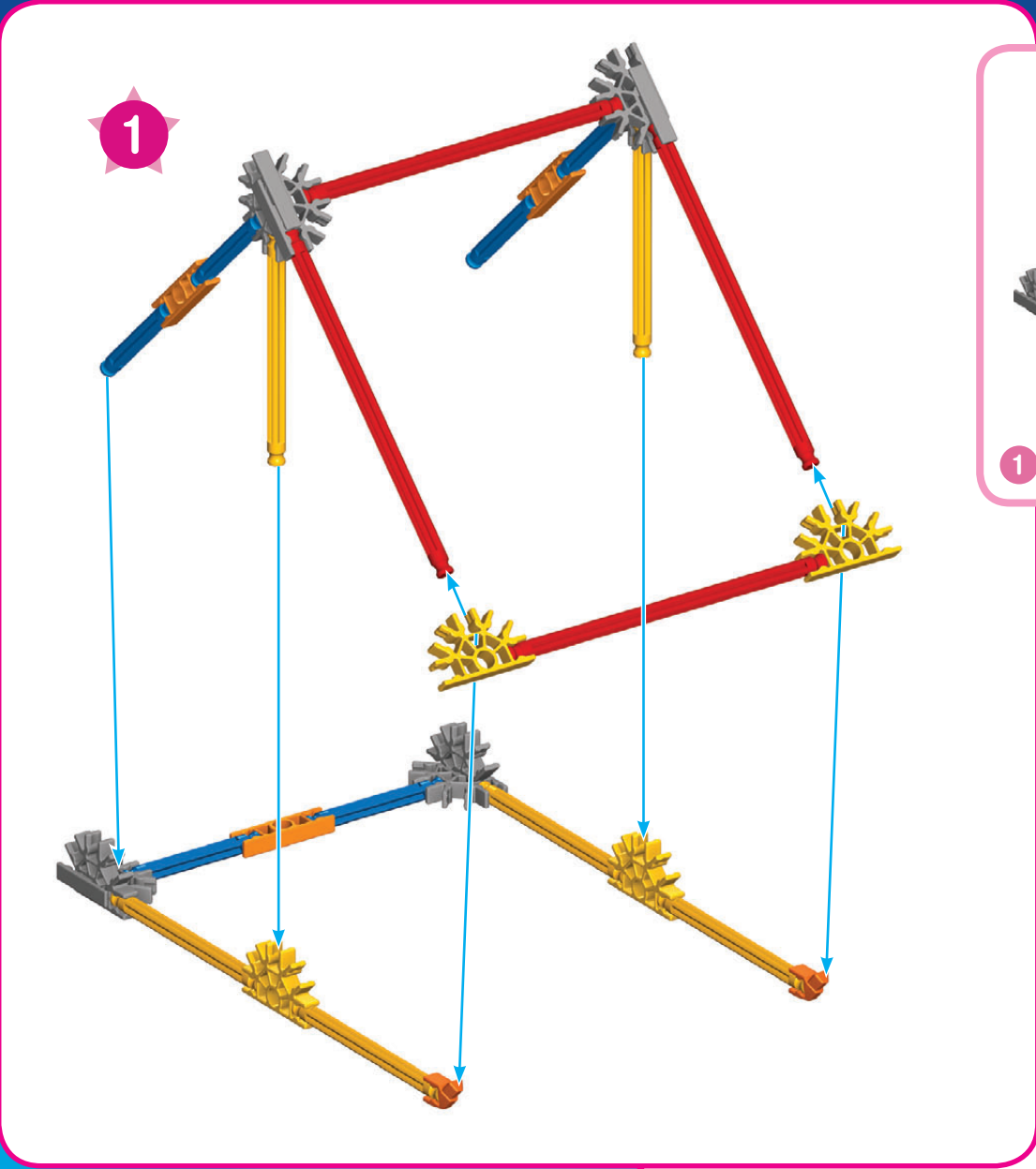

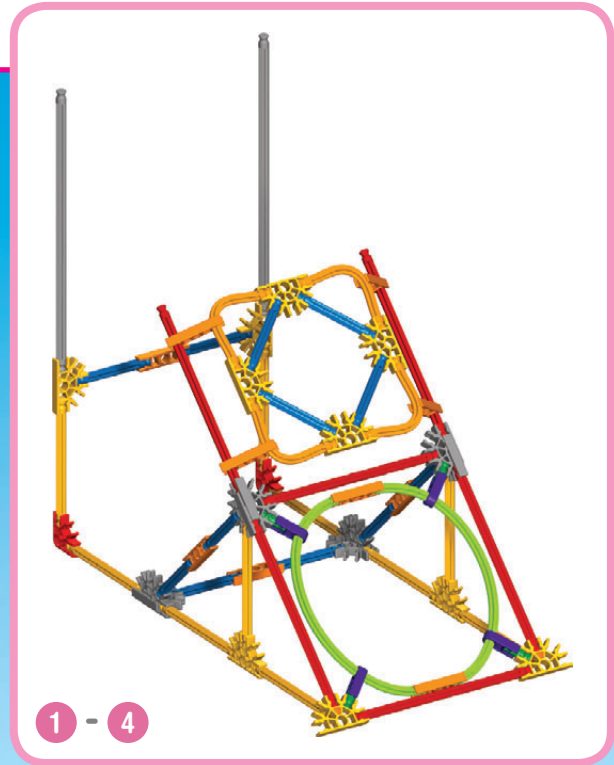
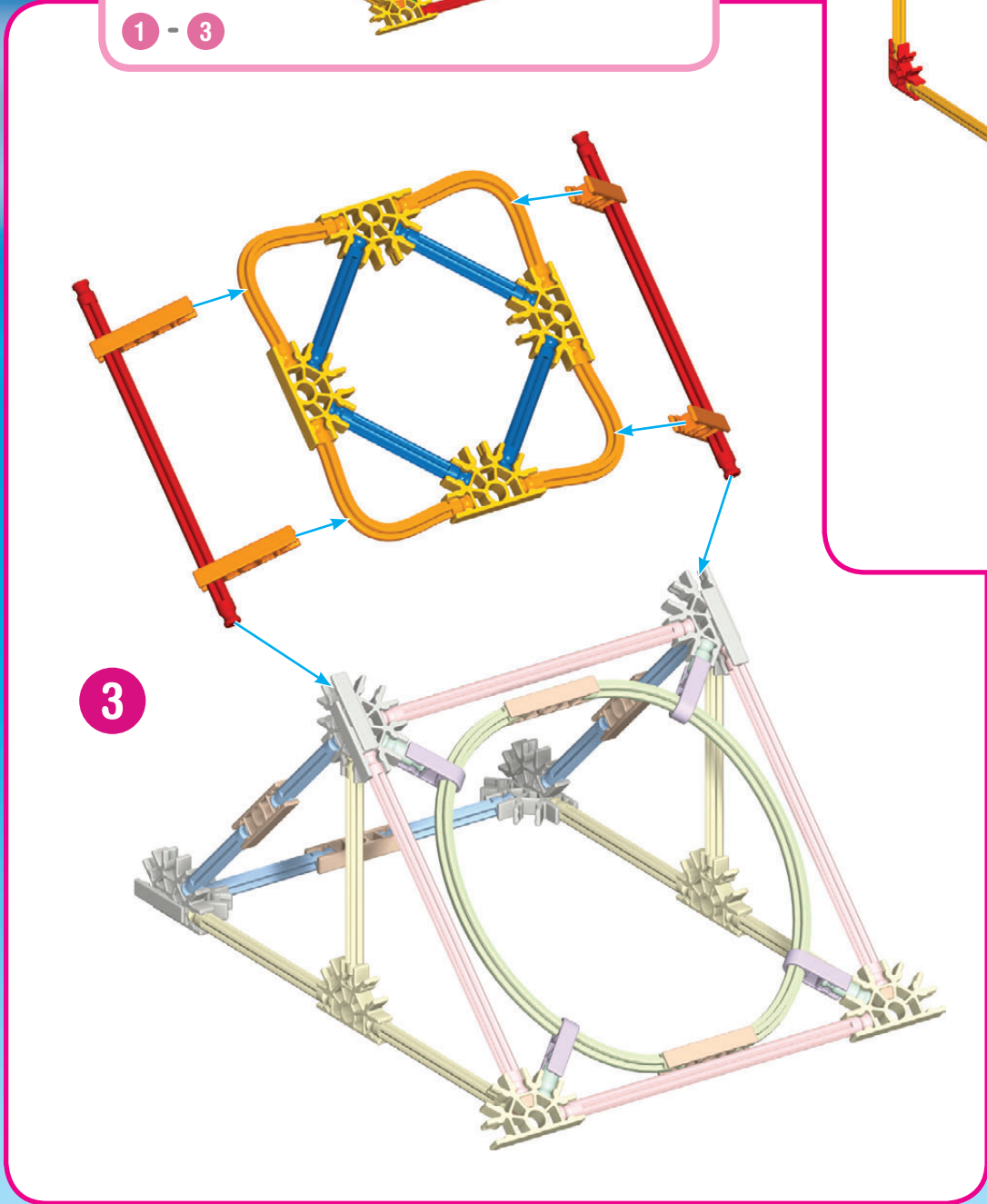
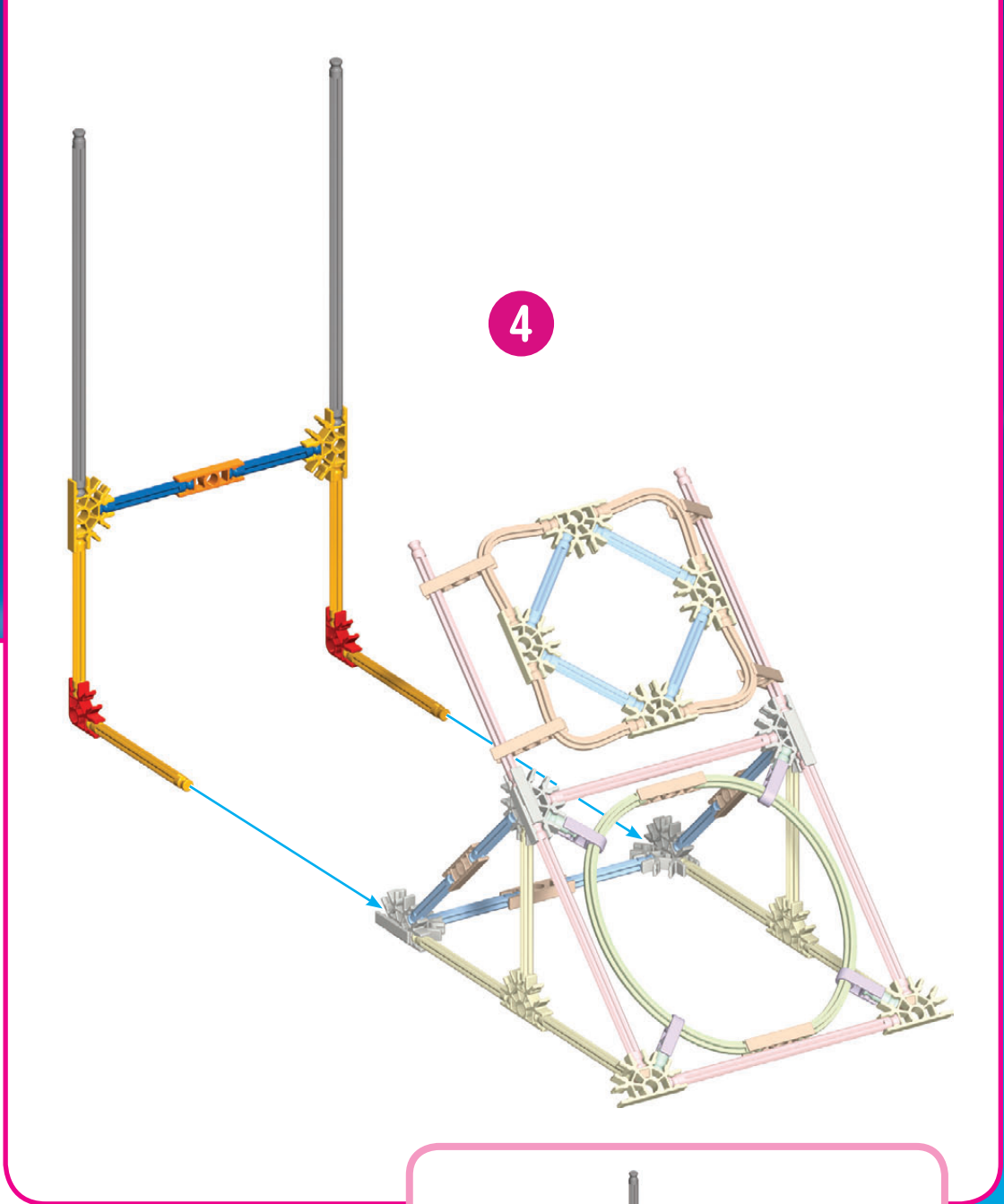
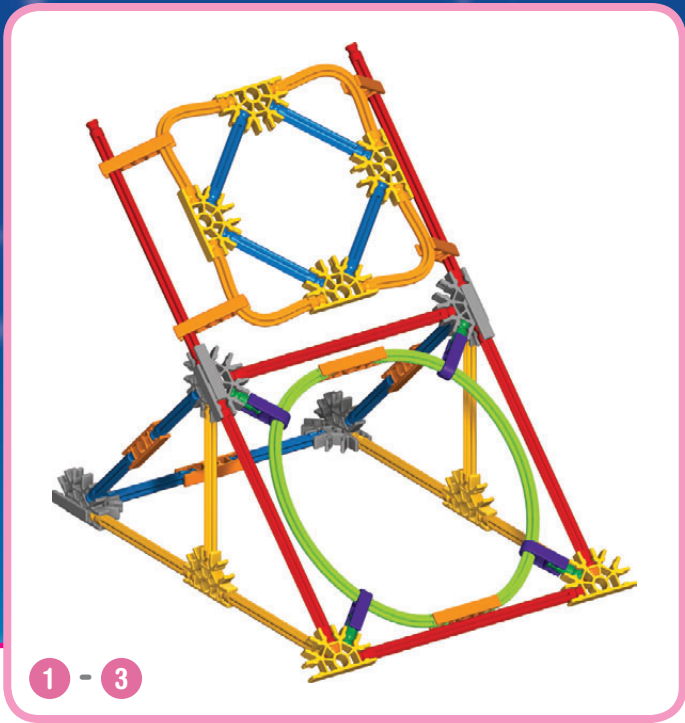

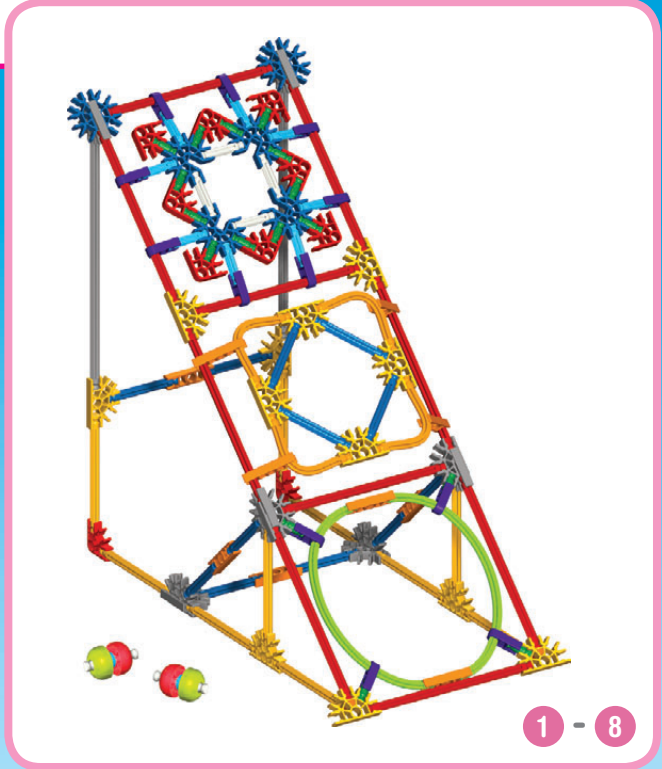
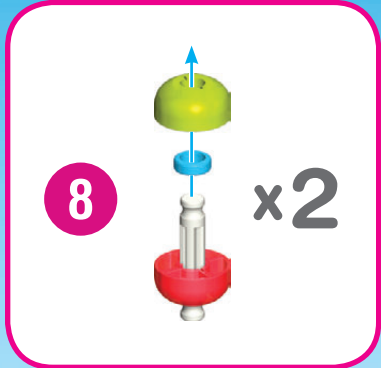
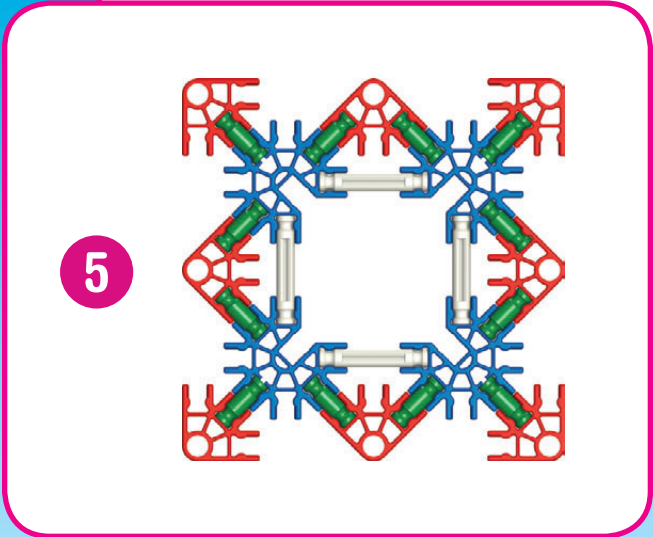
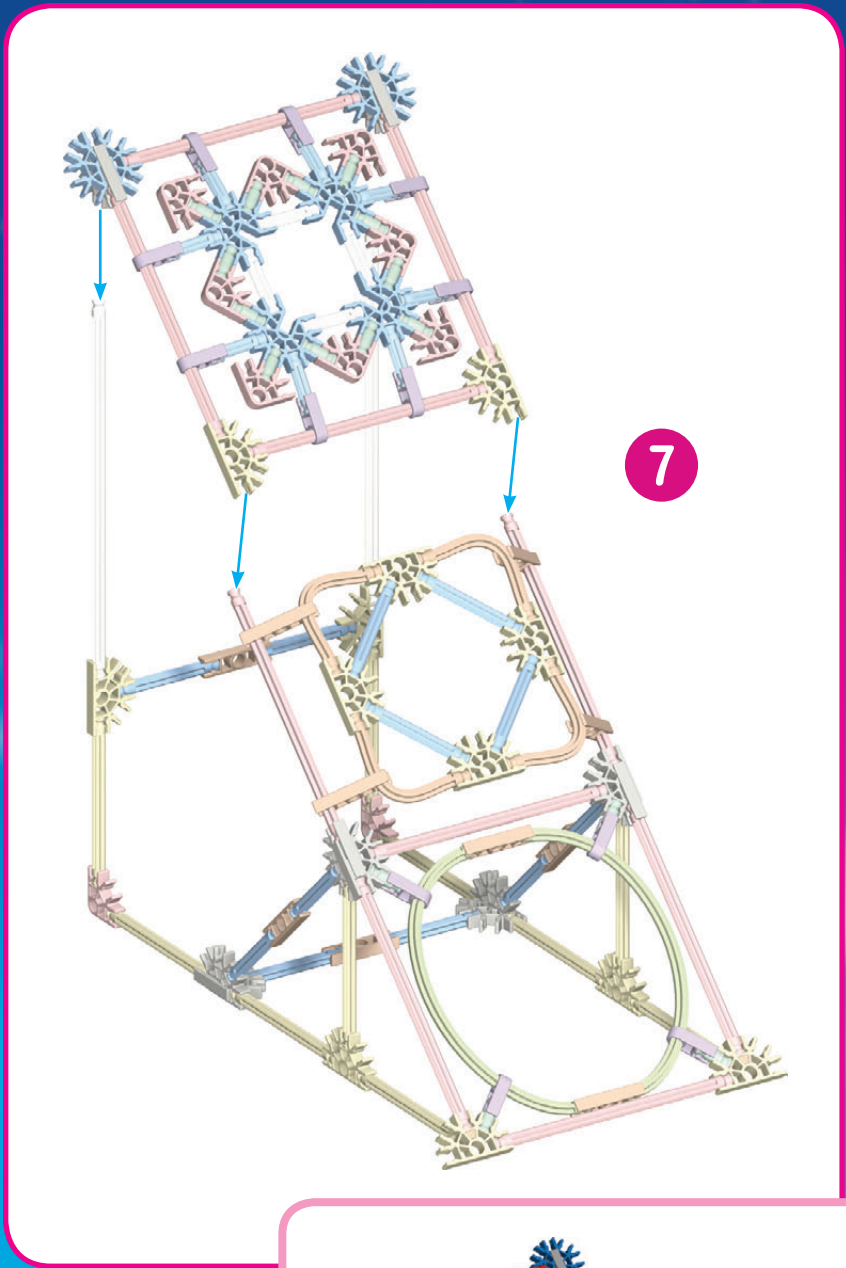
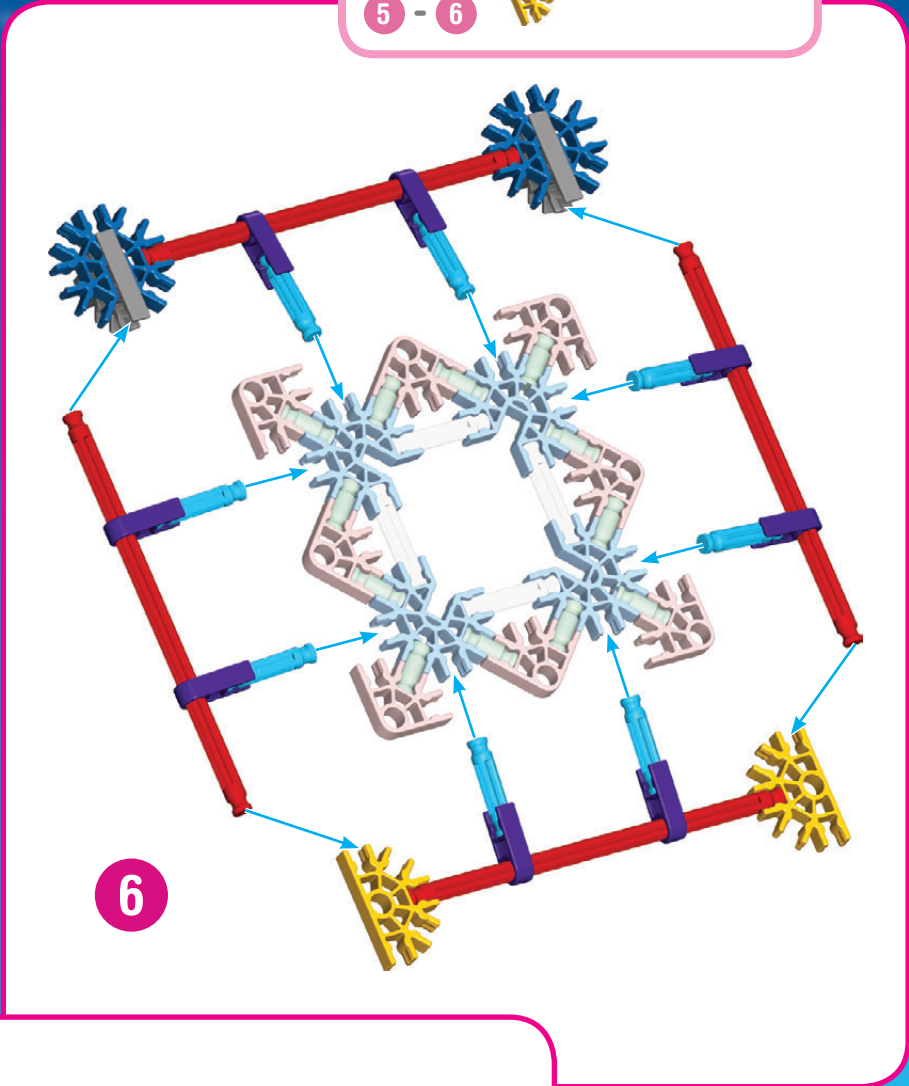
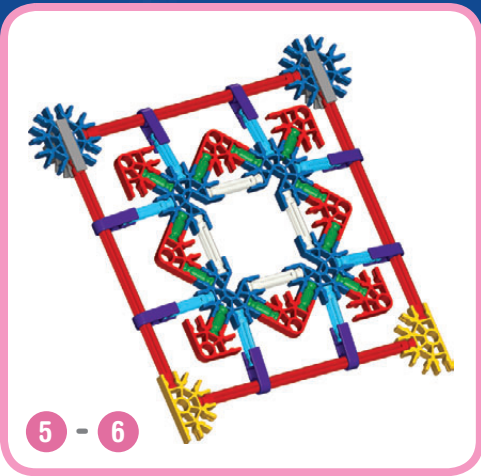

Alarm Clock Réveil

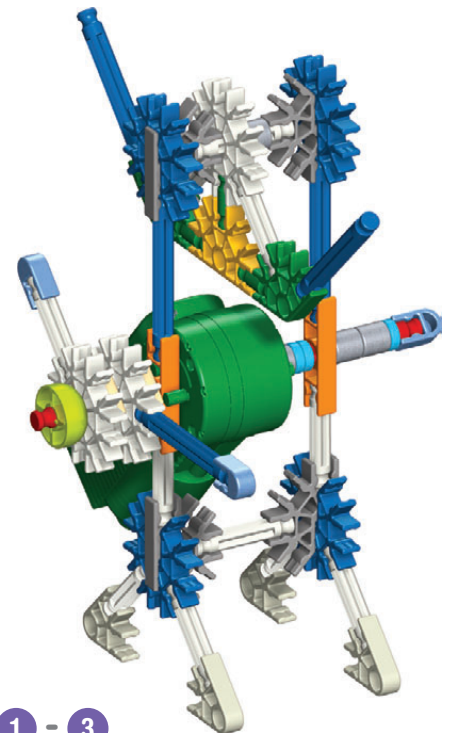
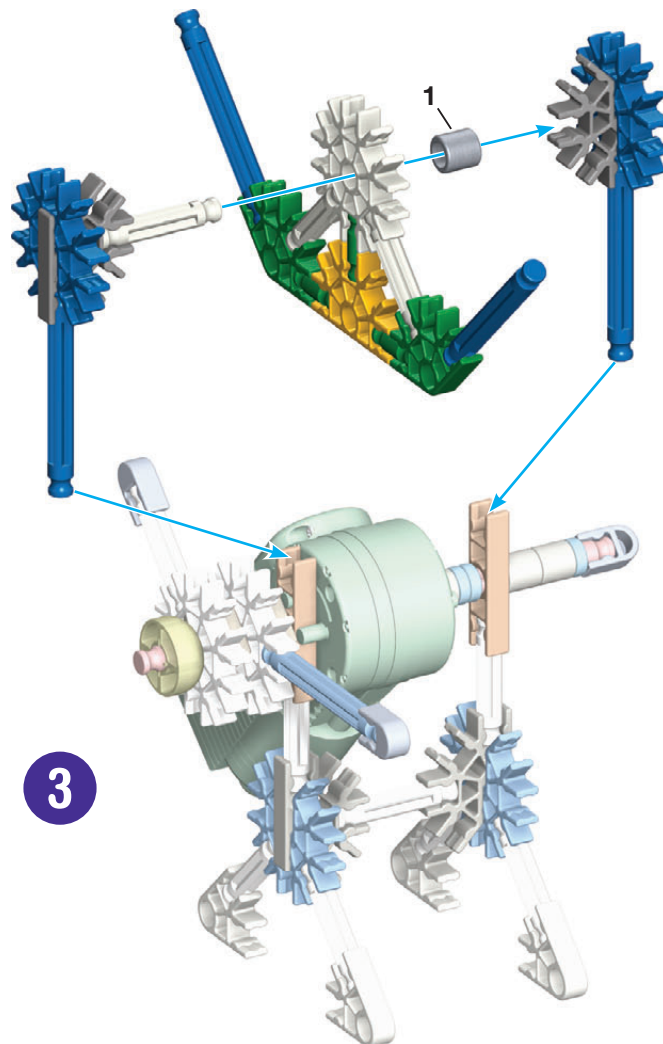
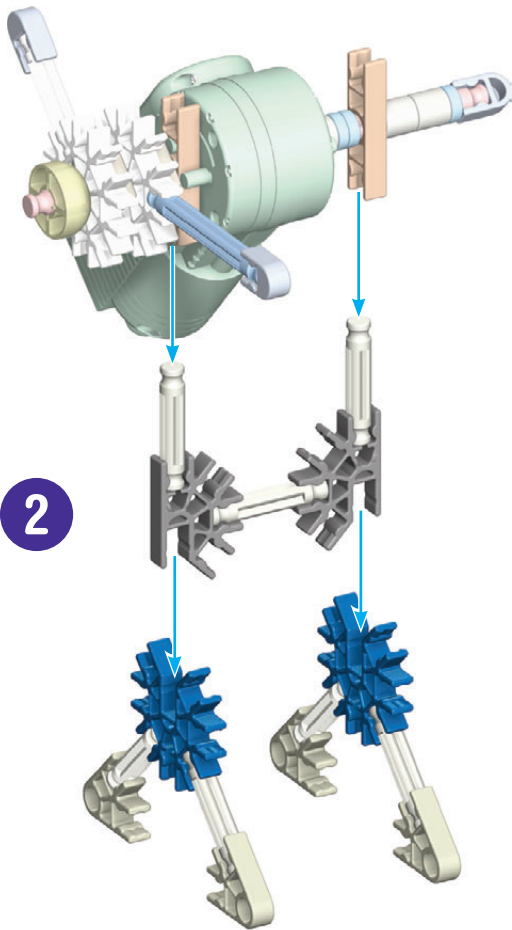
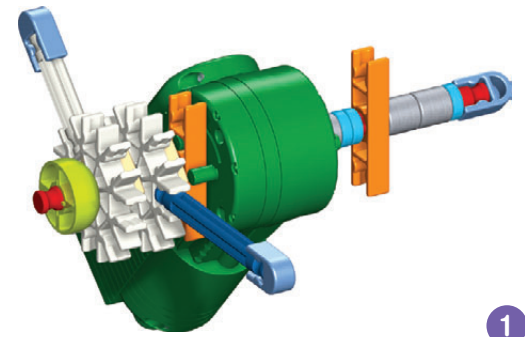
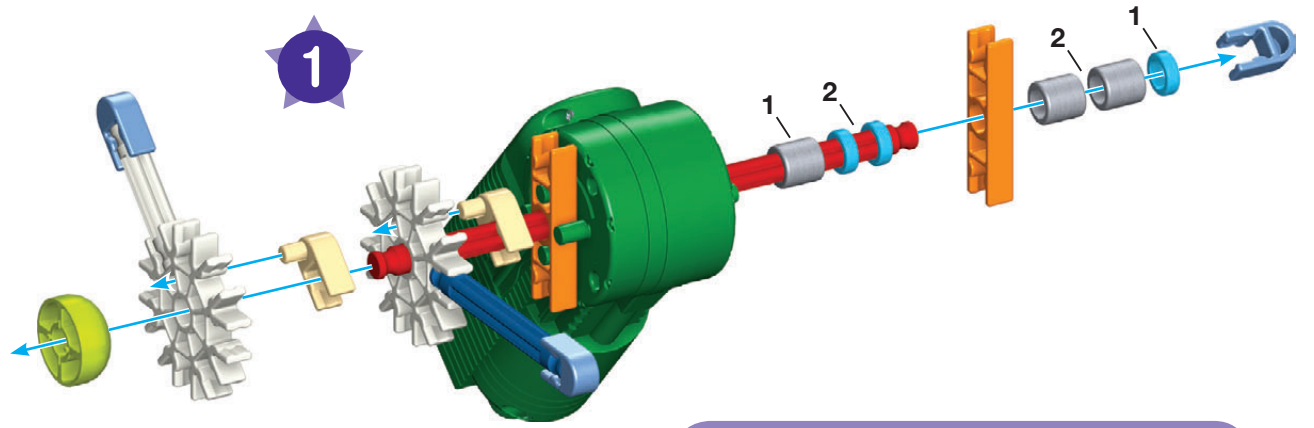
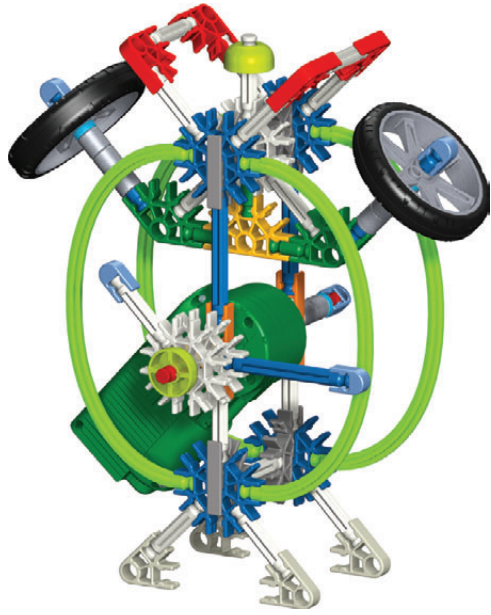

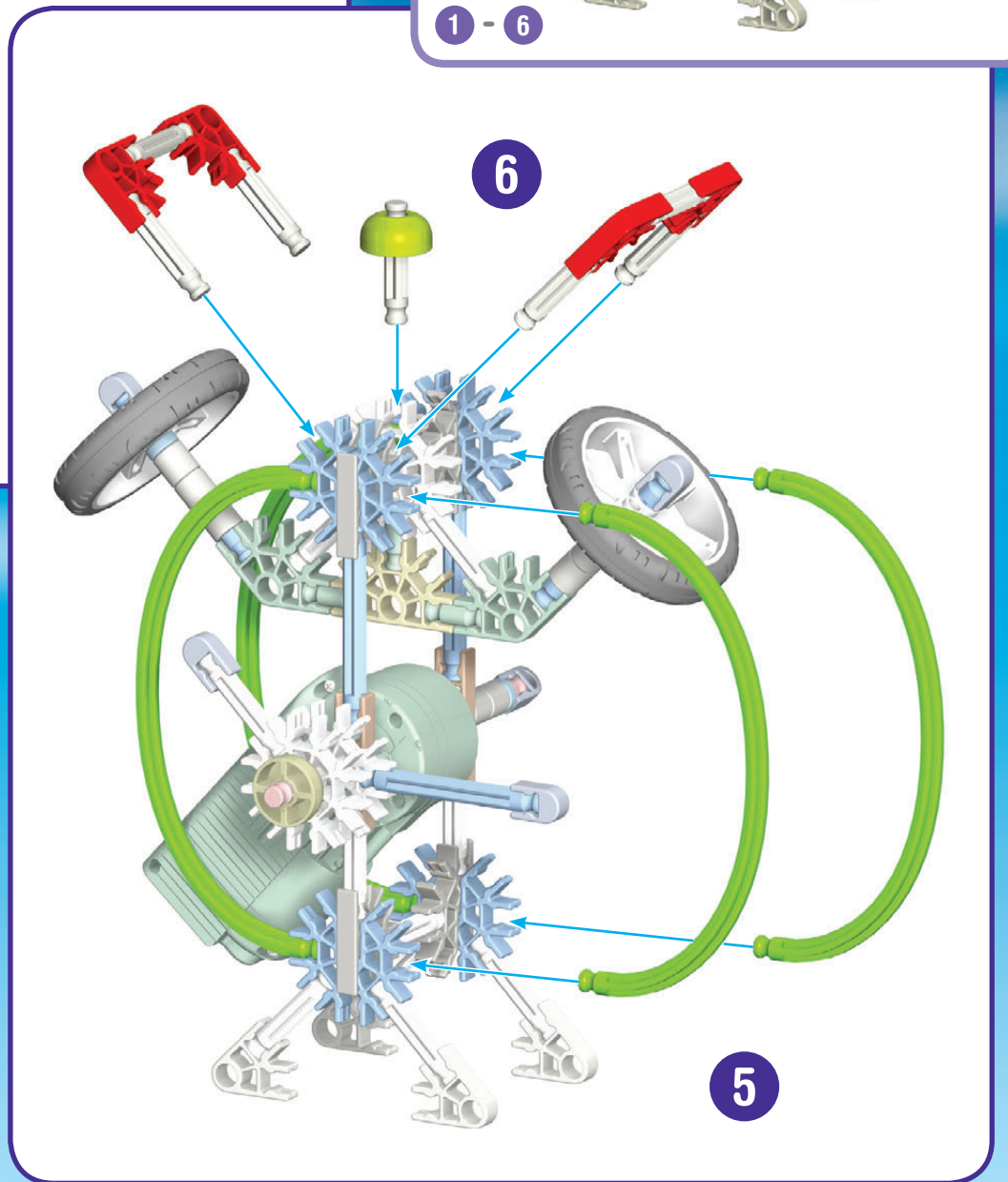
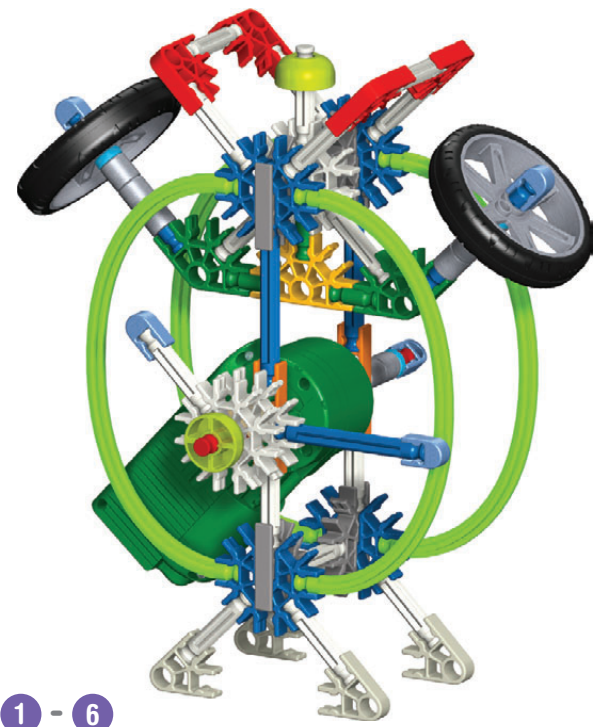
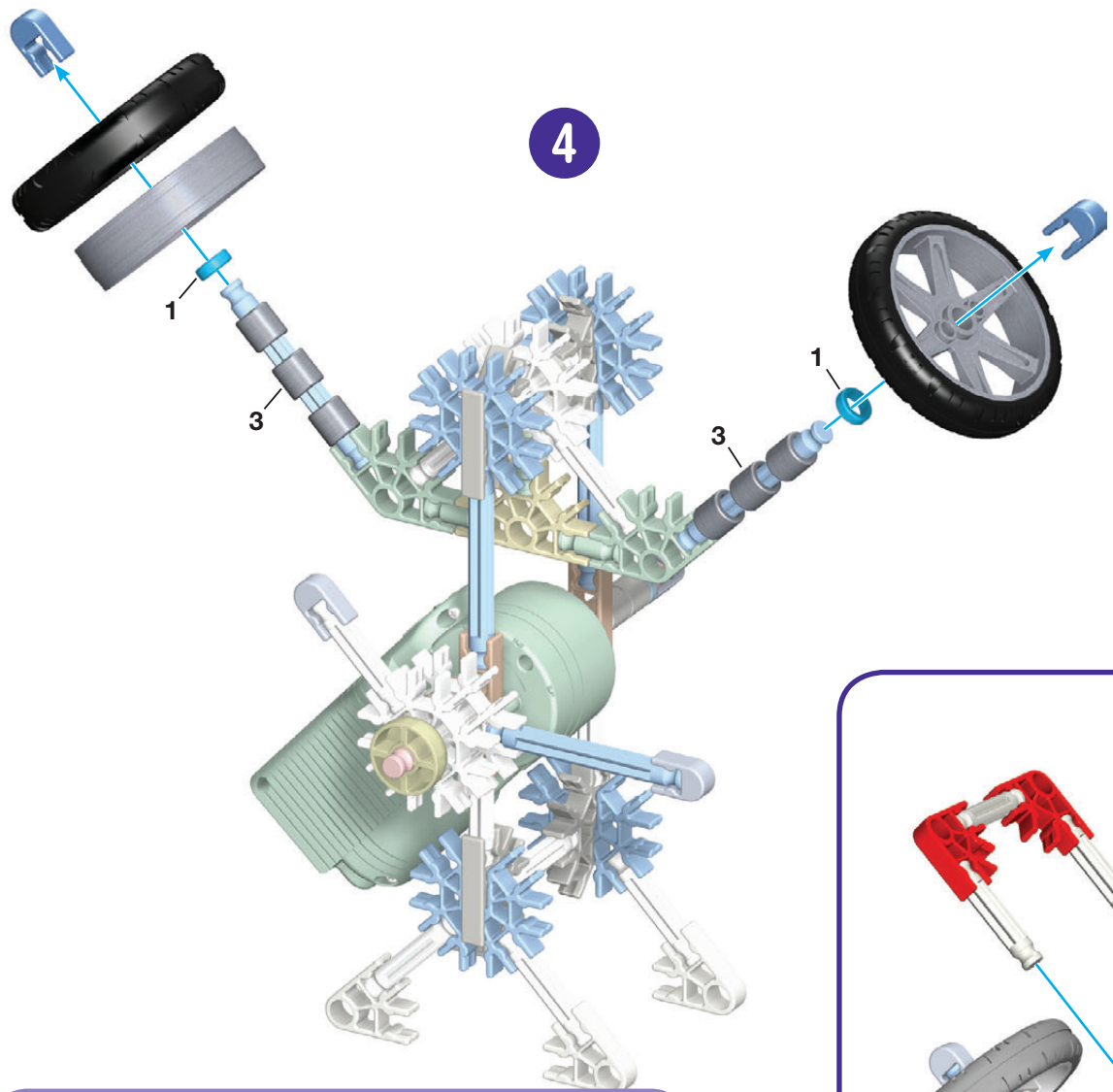

Carousel Carrusel

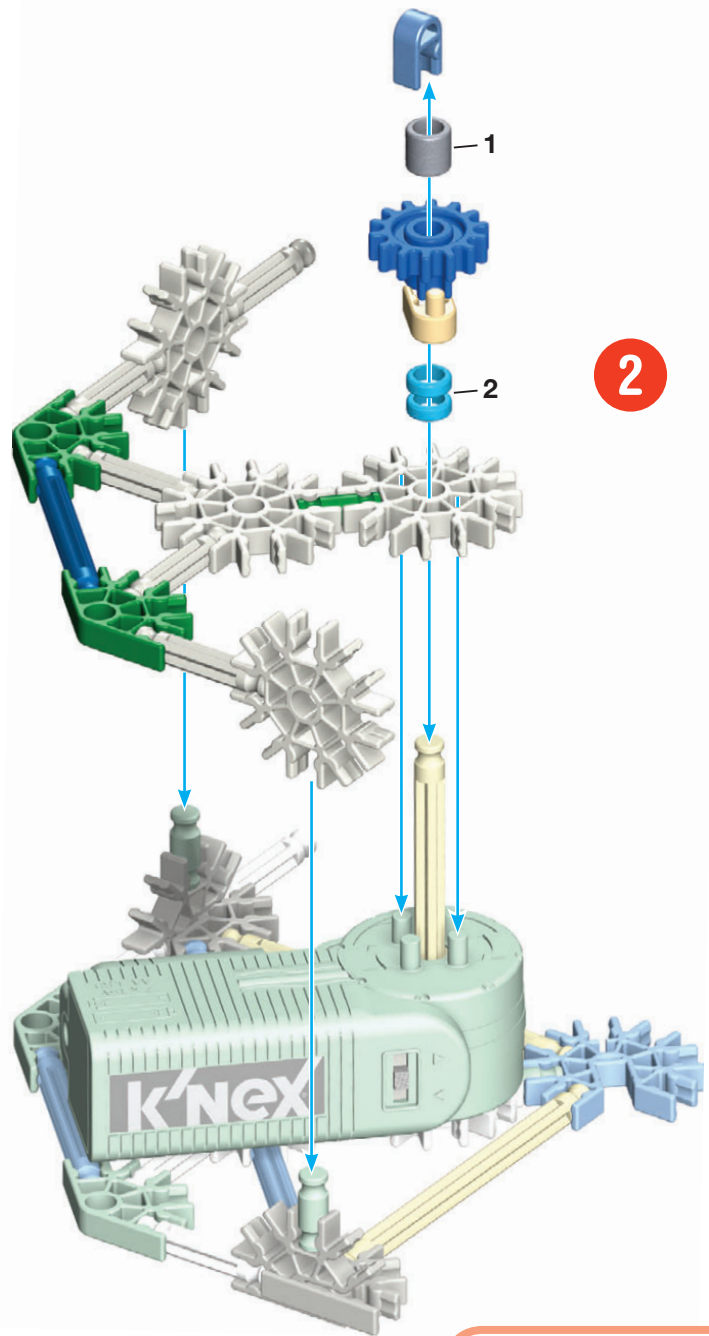

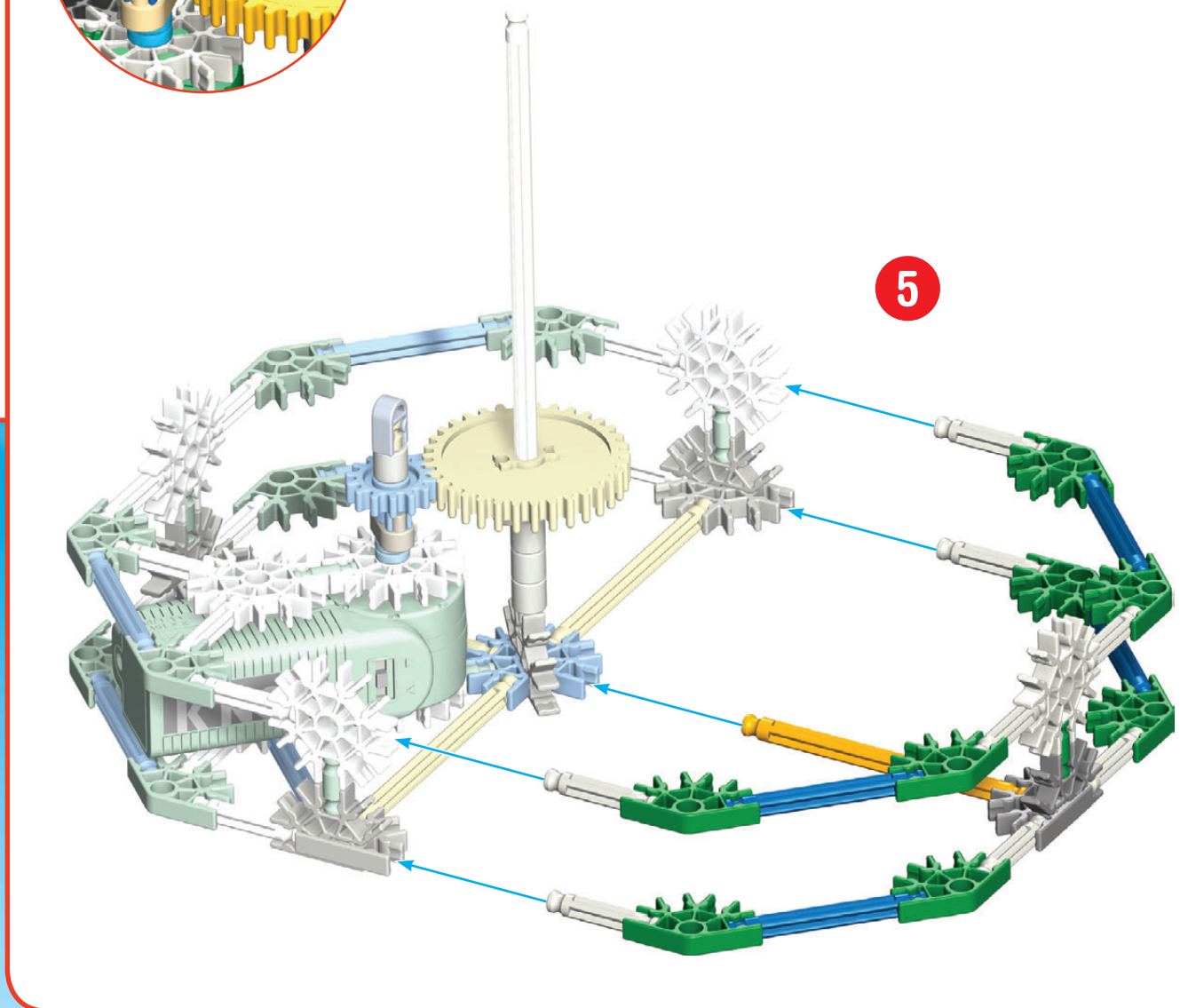
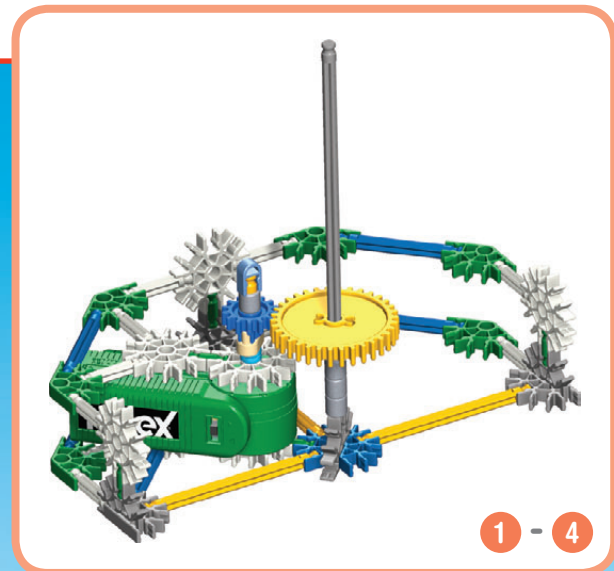
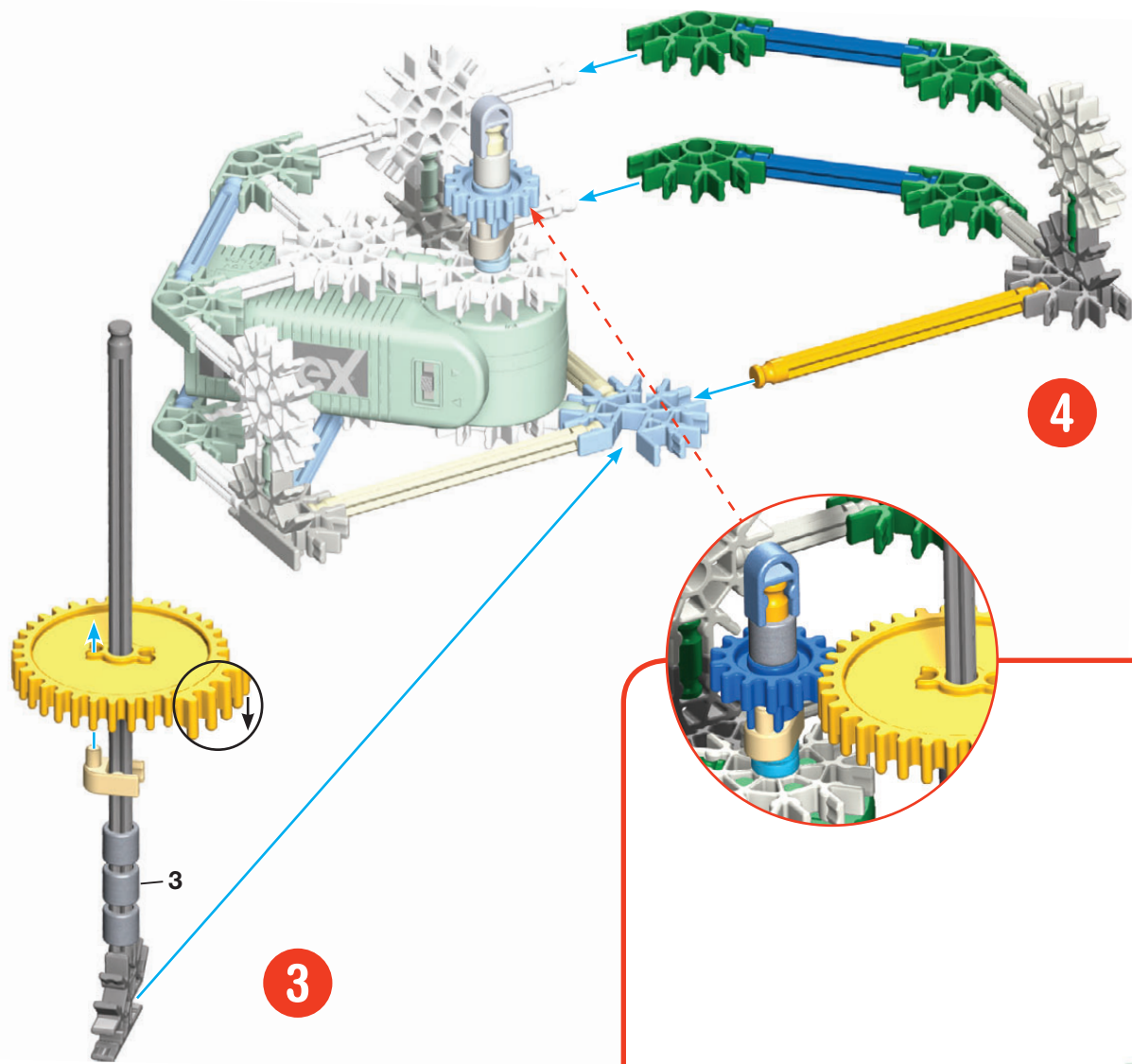

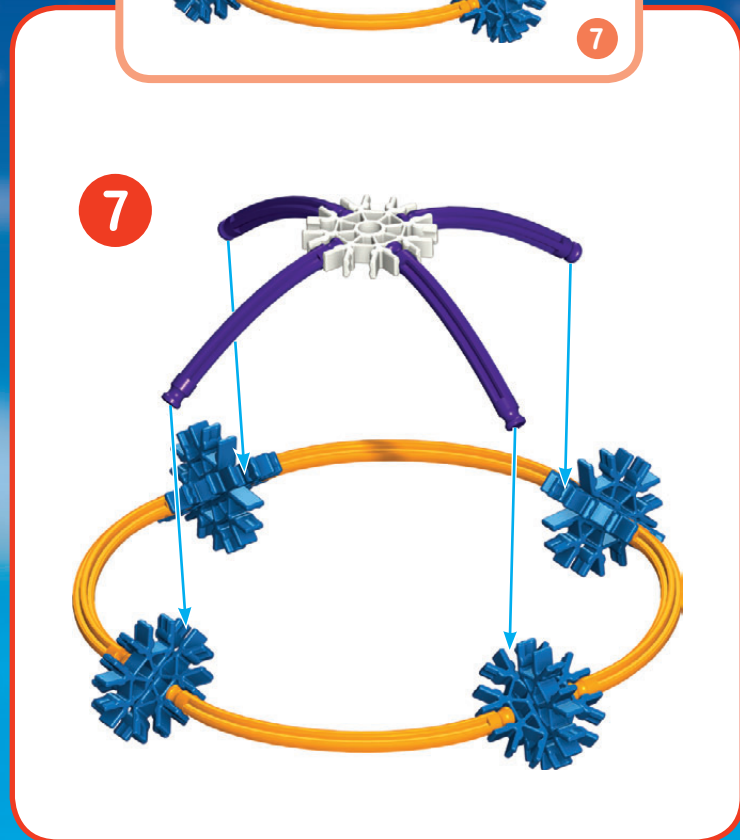
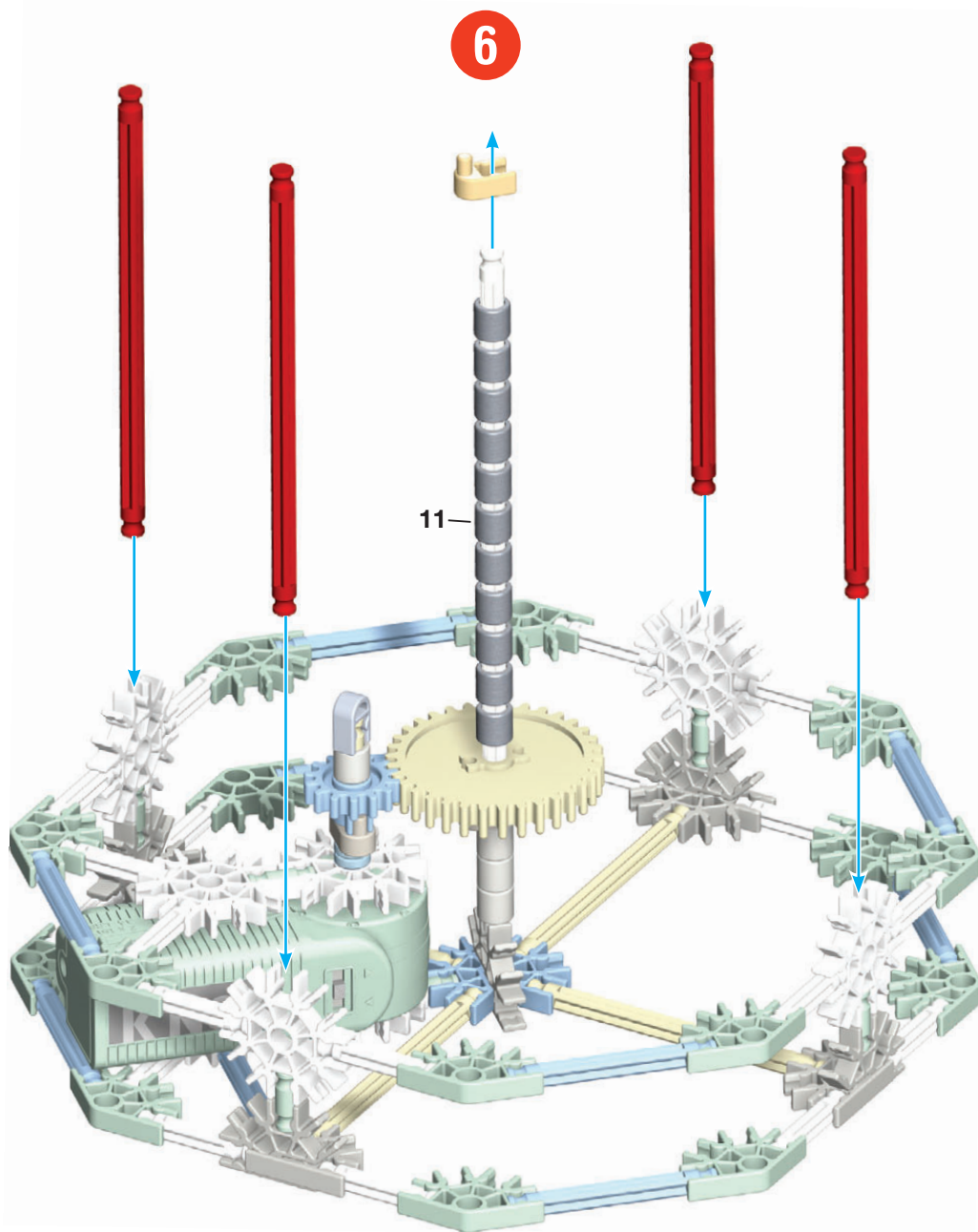

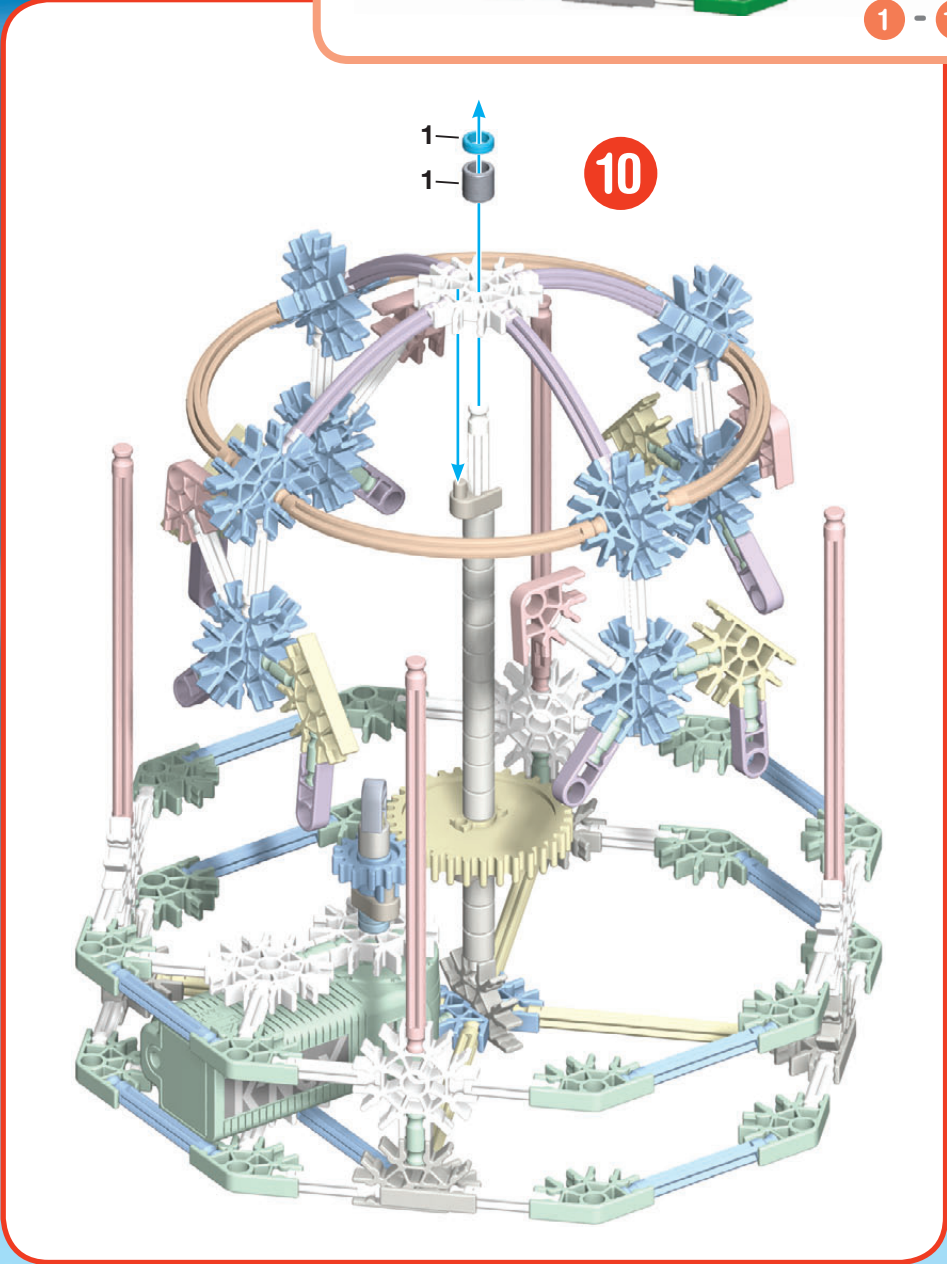
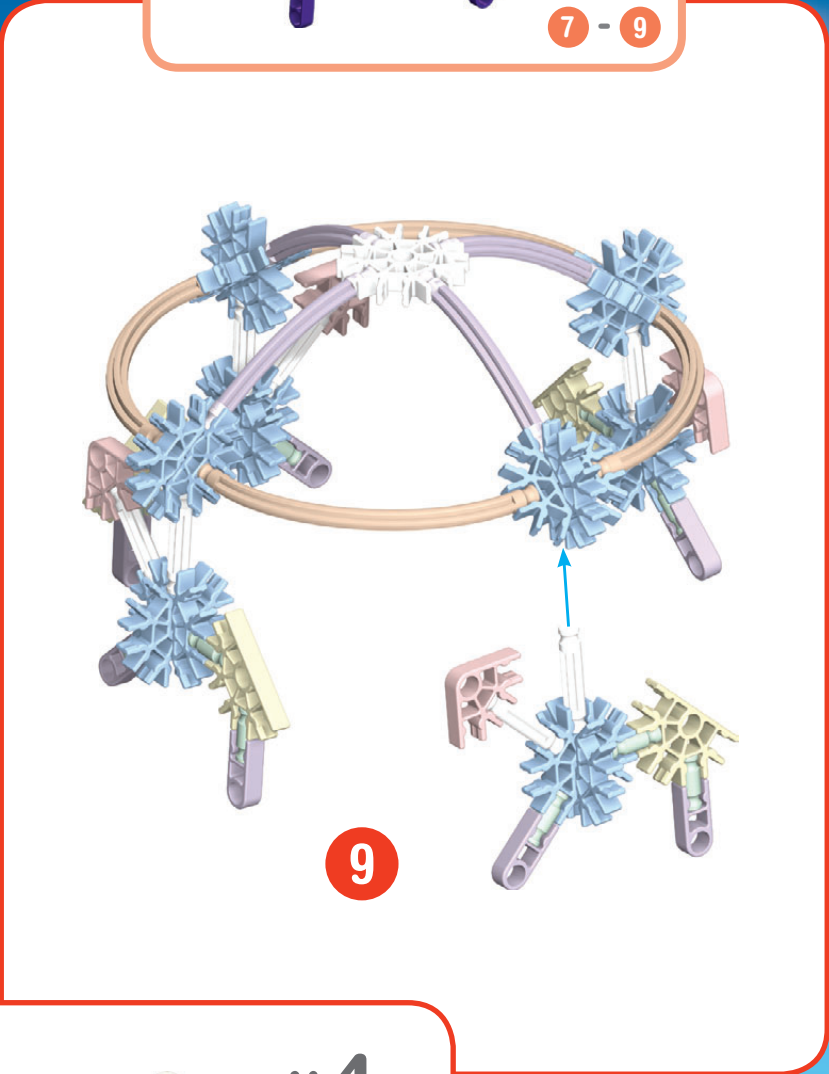

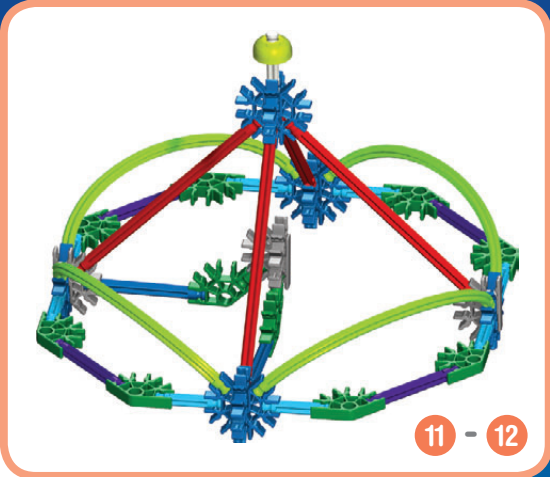

11 - 12

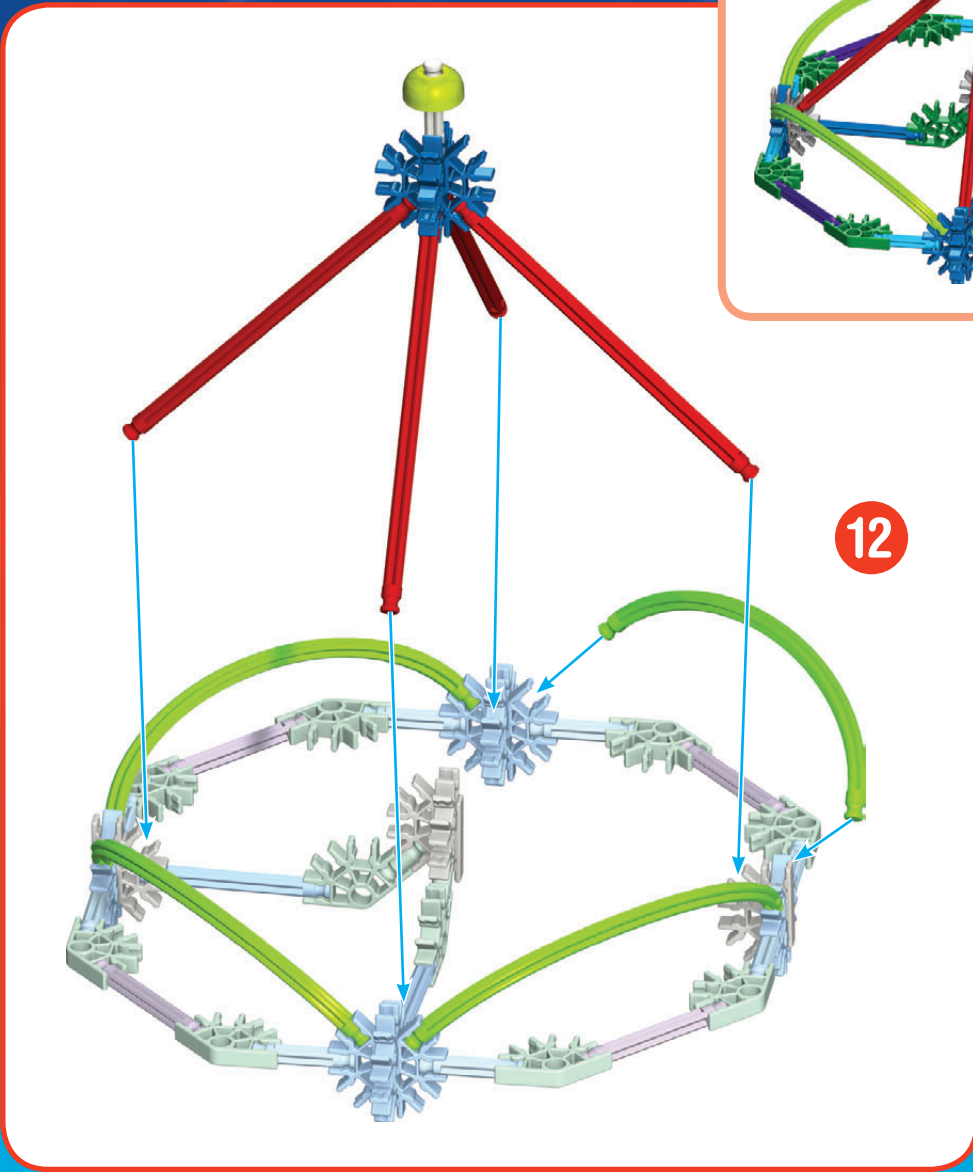

12



1 - 13

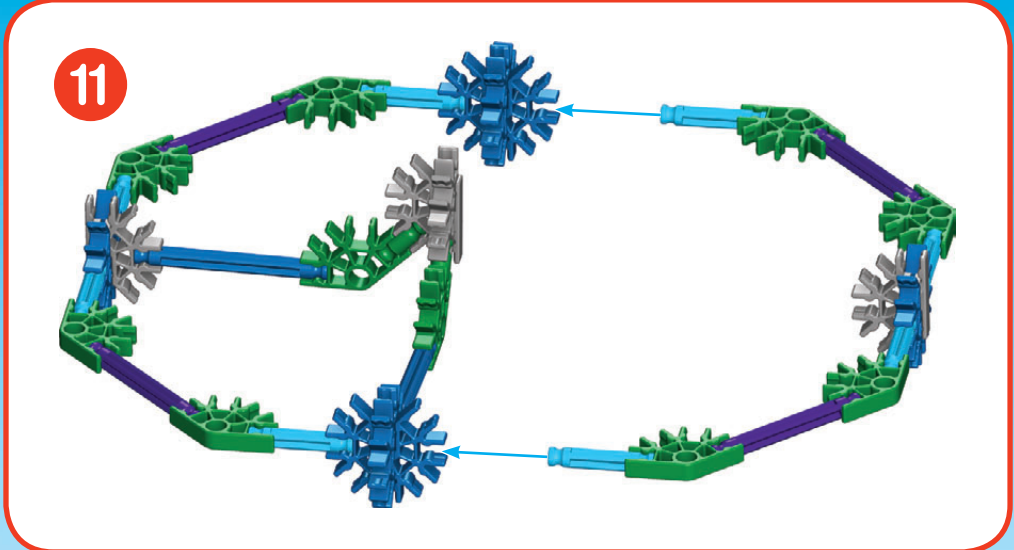

11

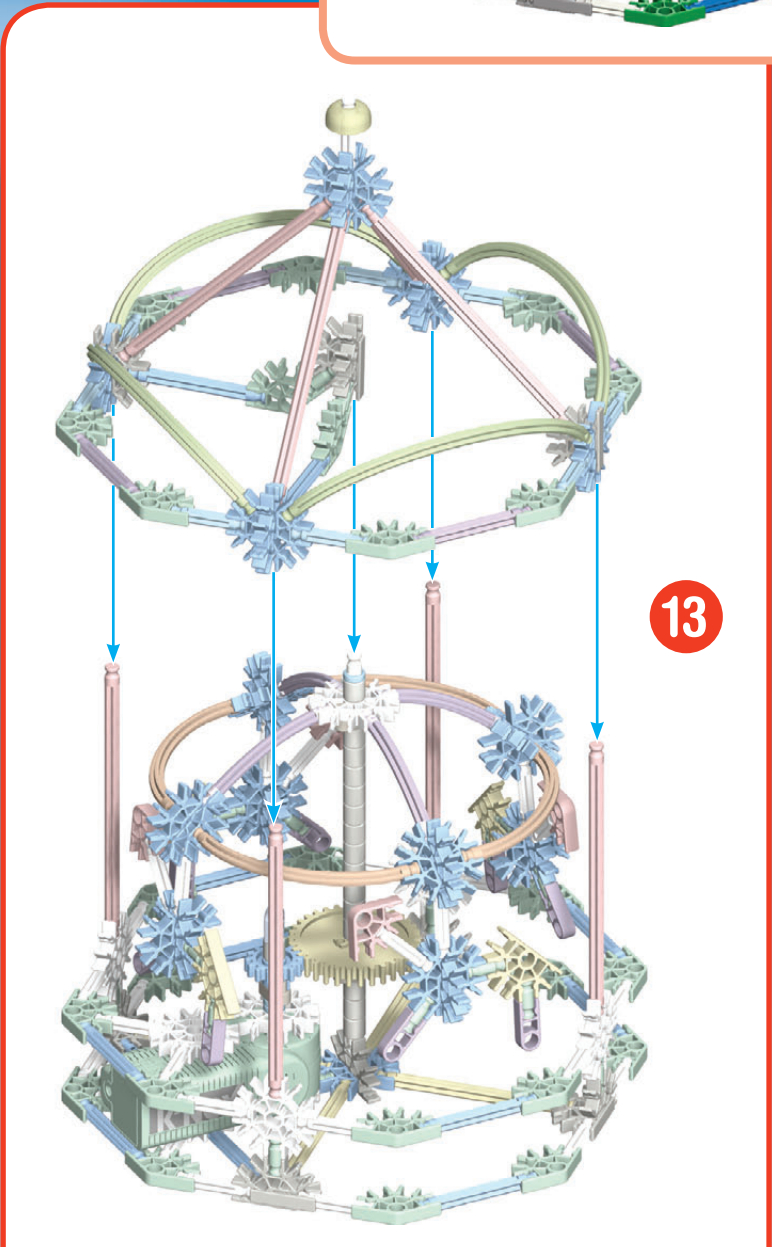

13

1

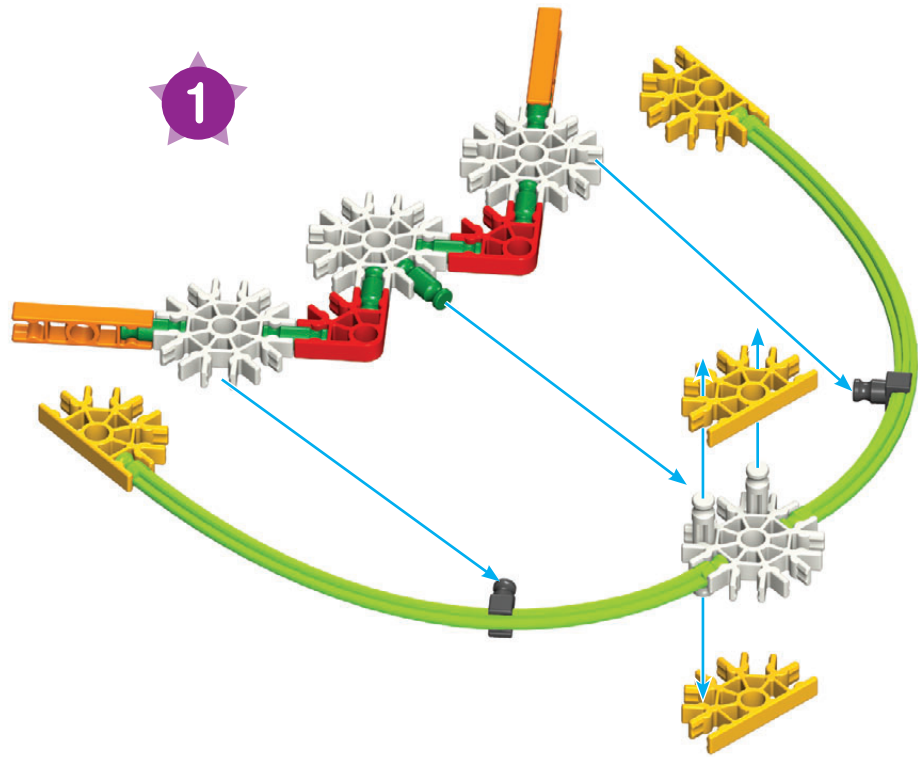

1 - 2

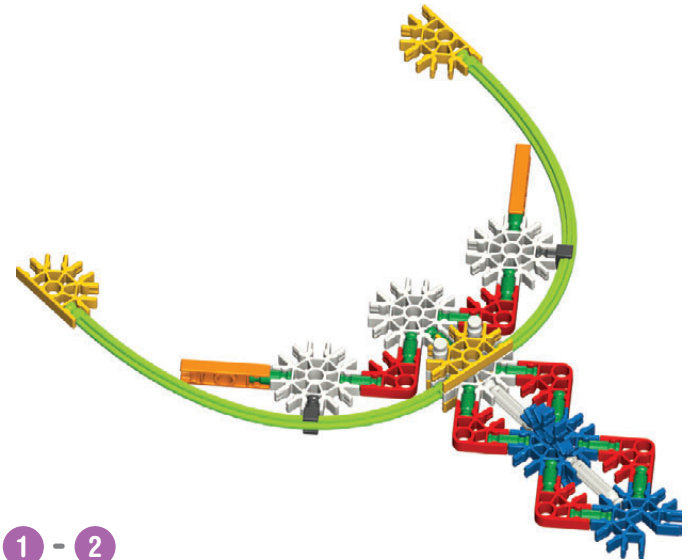

1

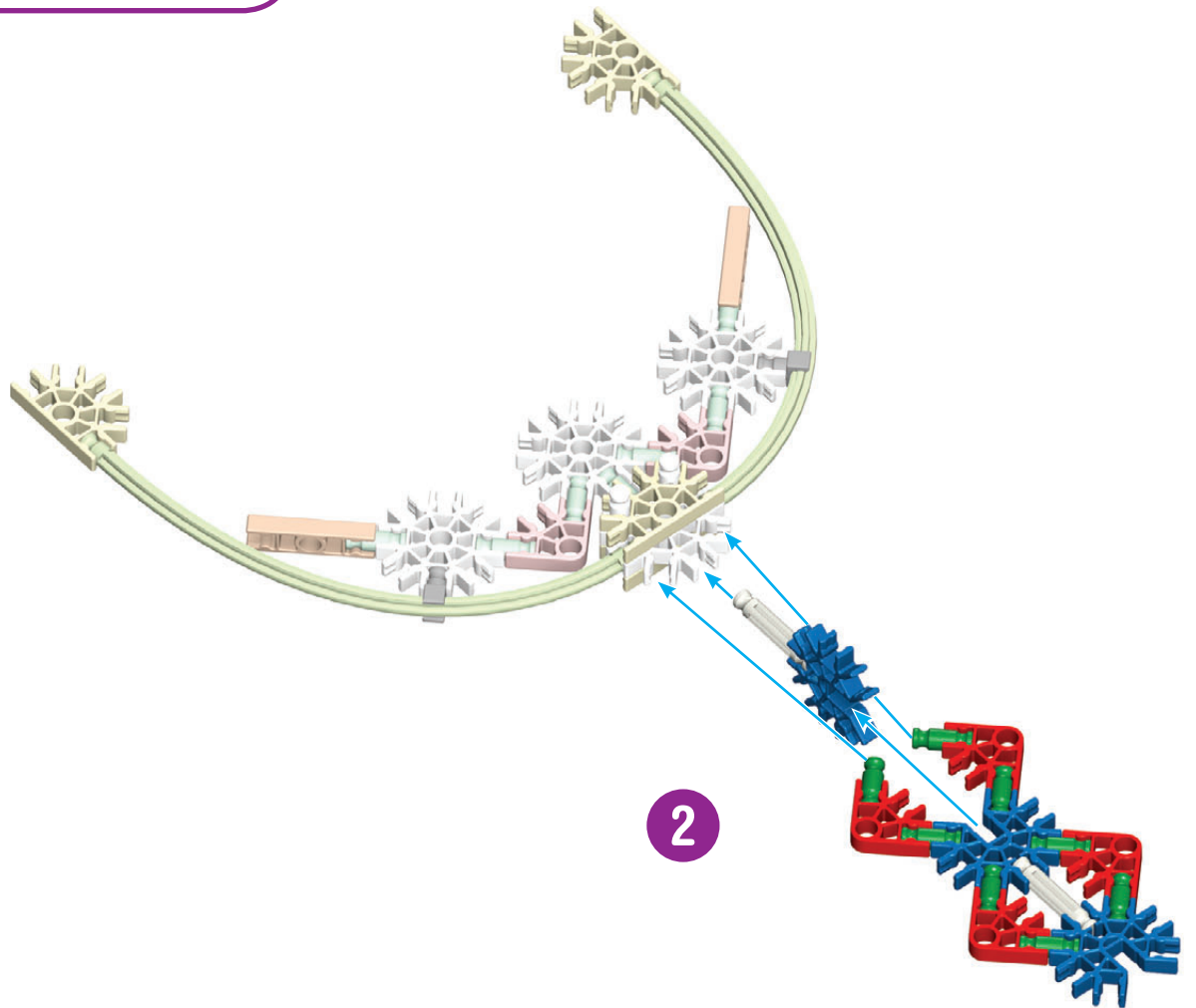
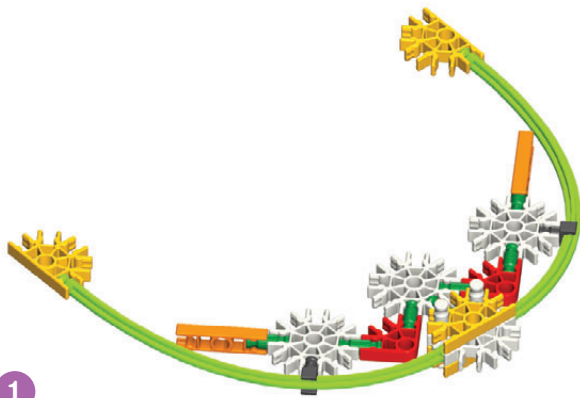

2

Tennis Racquet
Raquette de Tennis

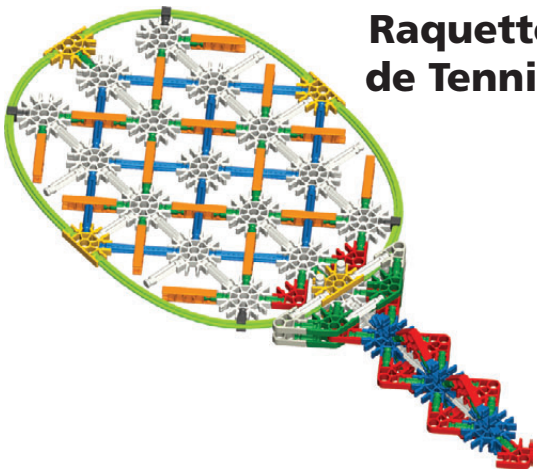

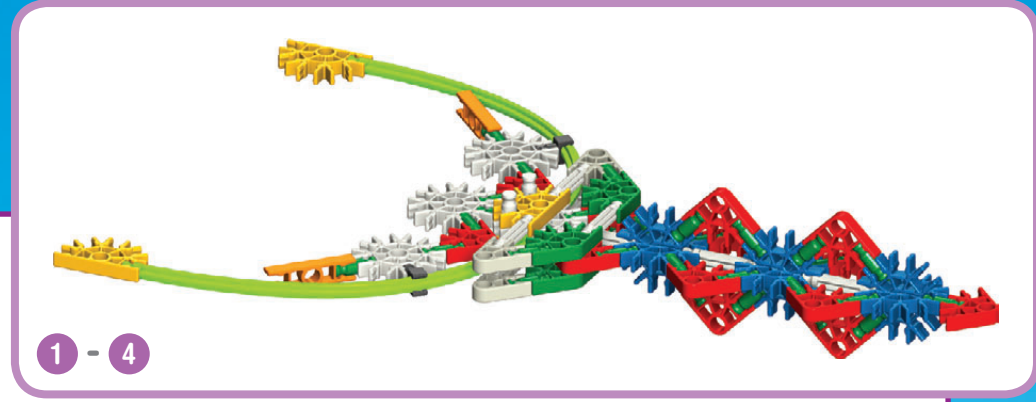
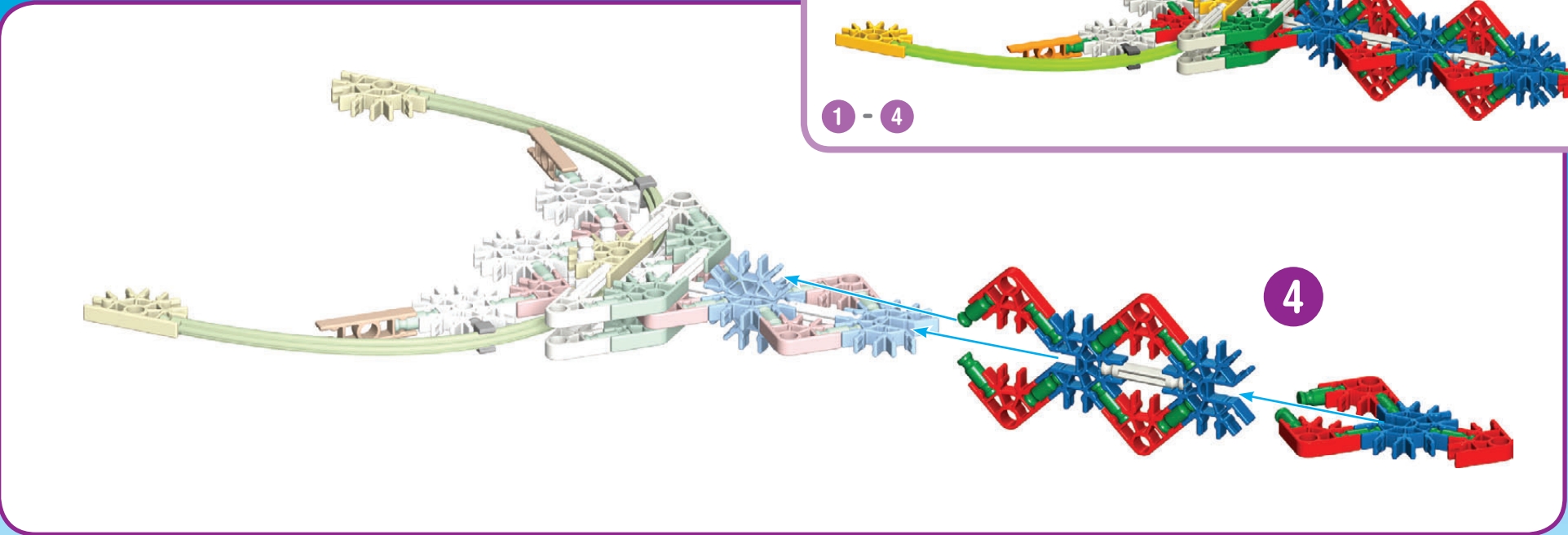
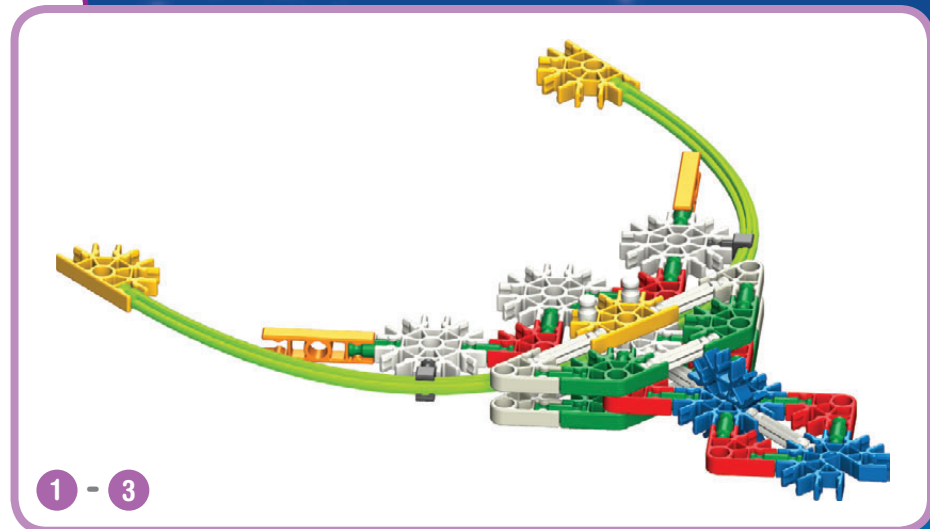
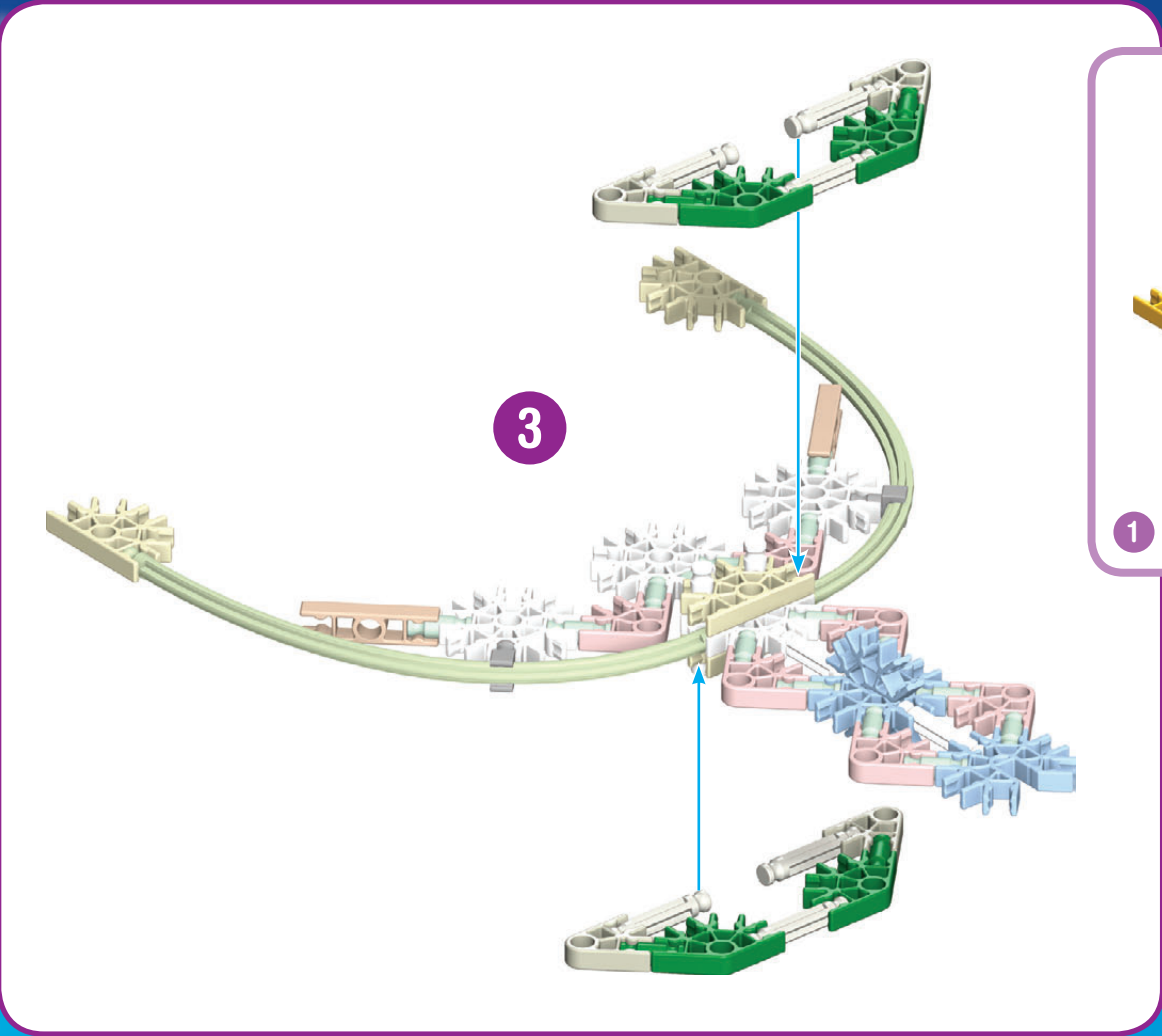

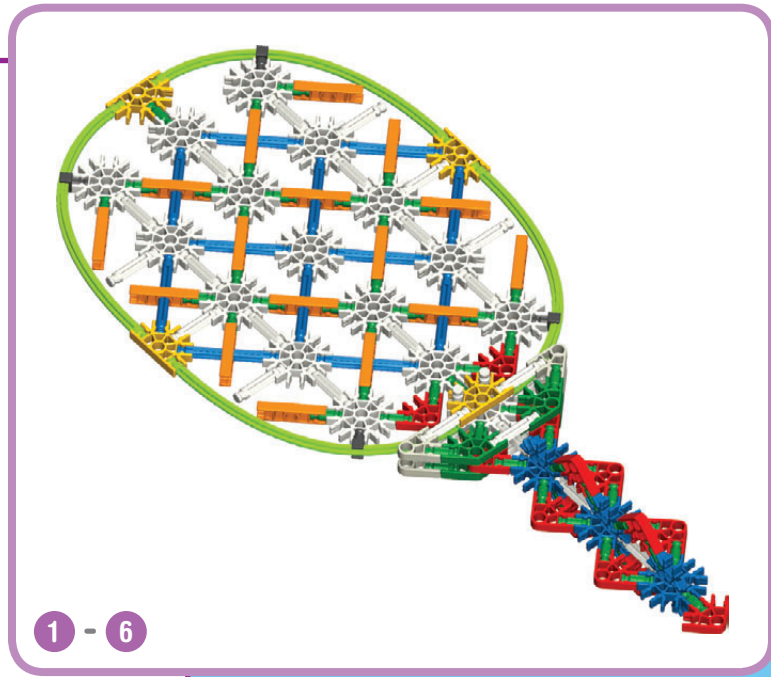
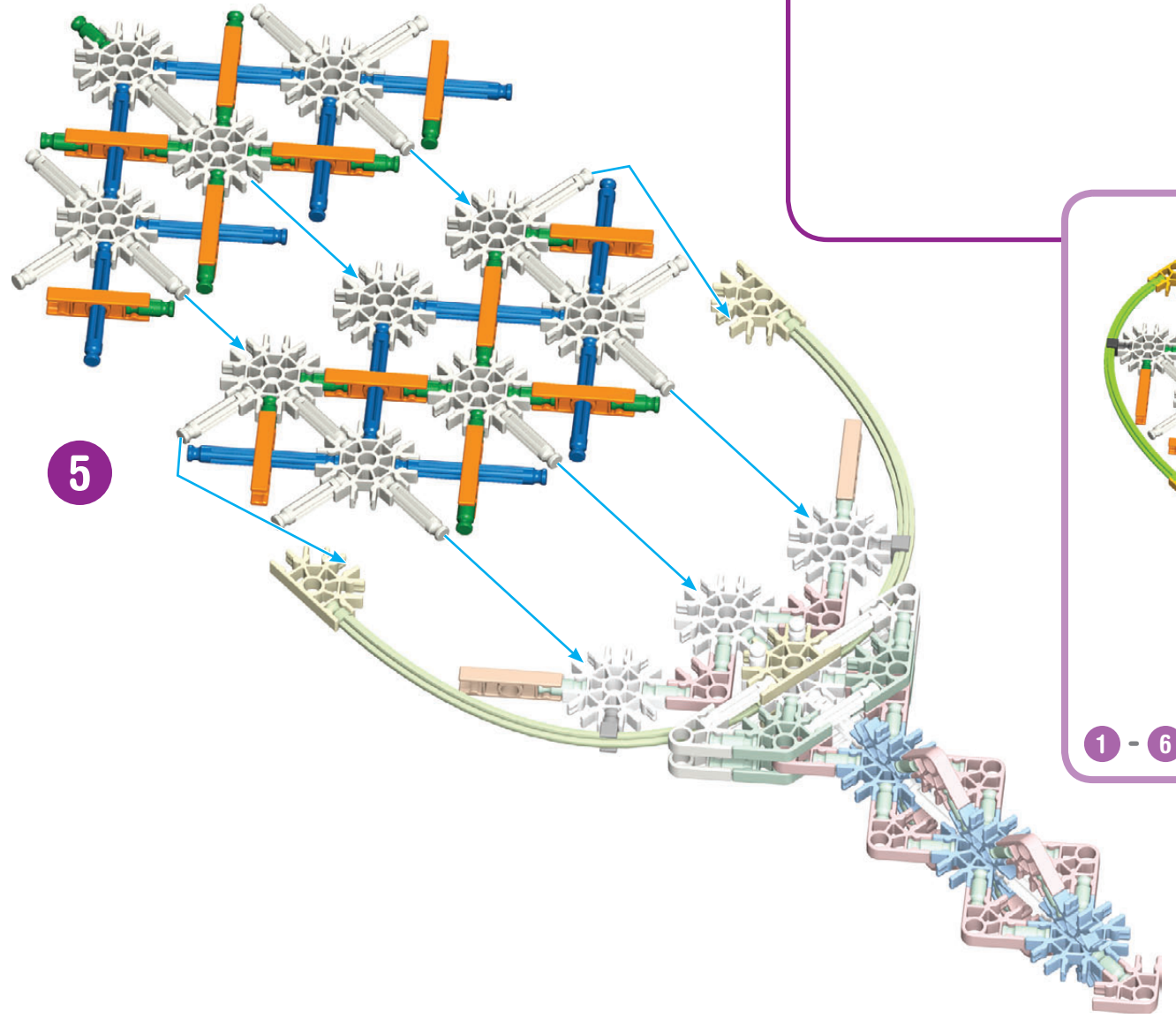
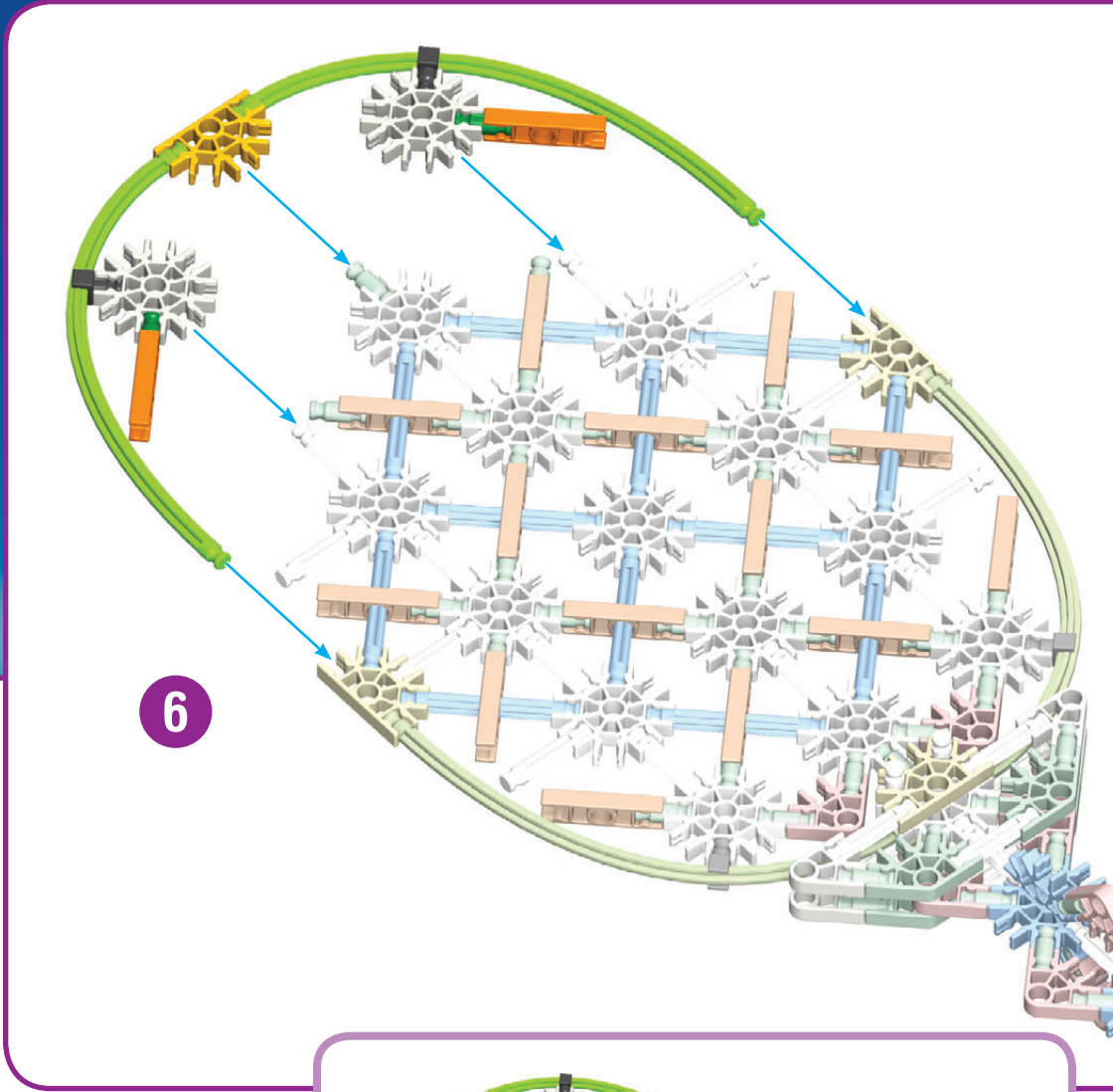
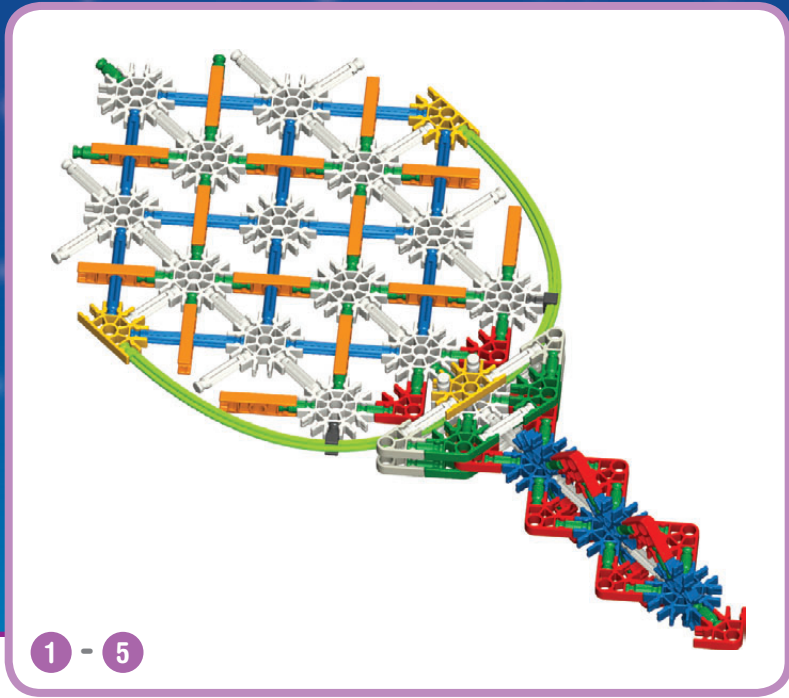

Tractor Tracteur

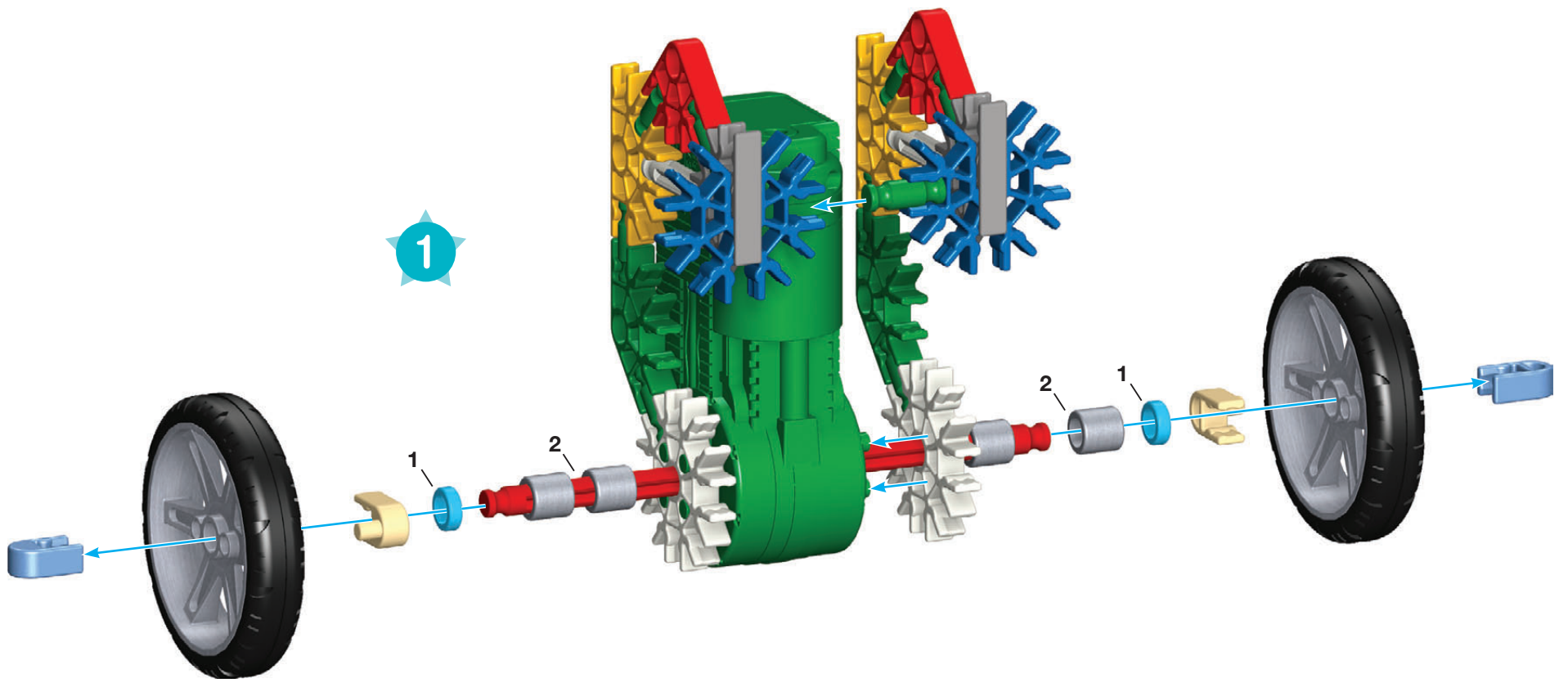
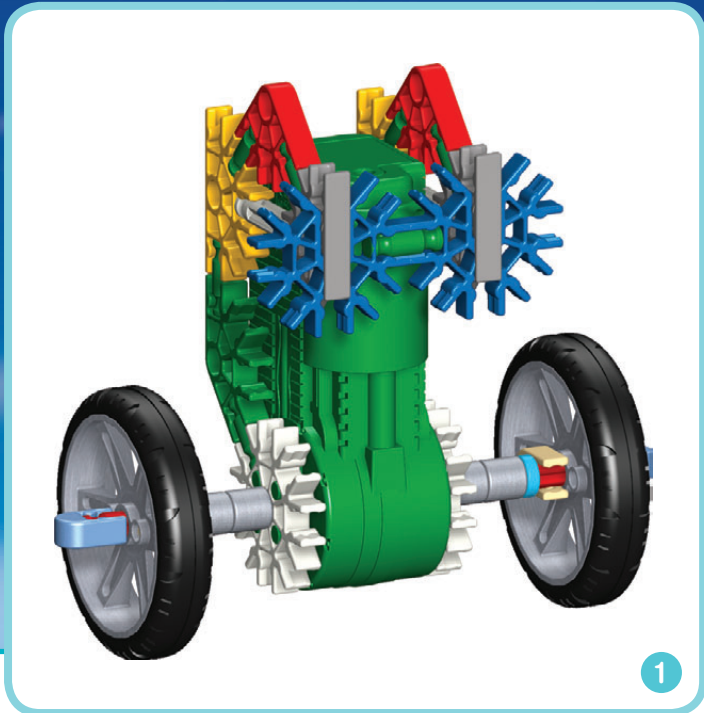
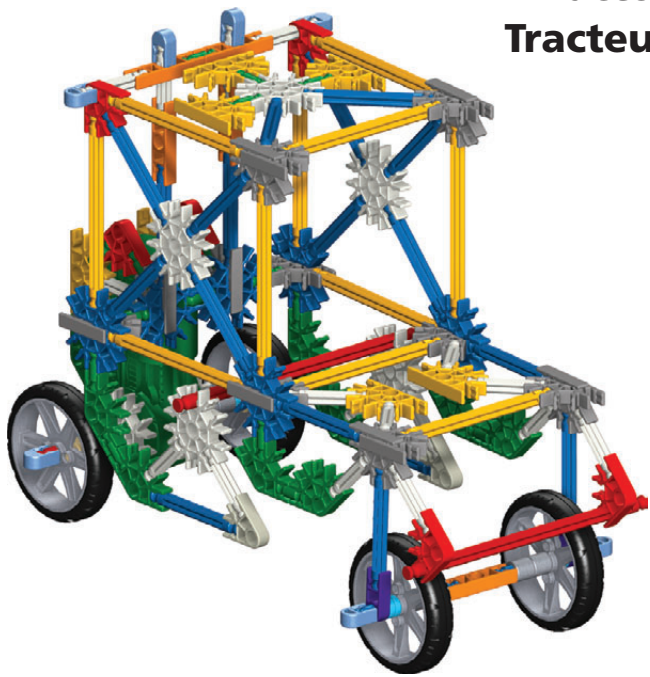

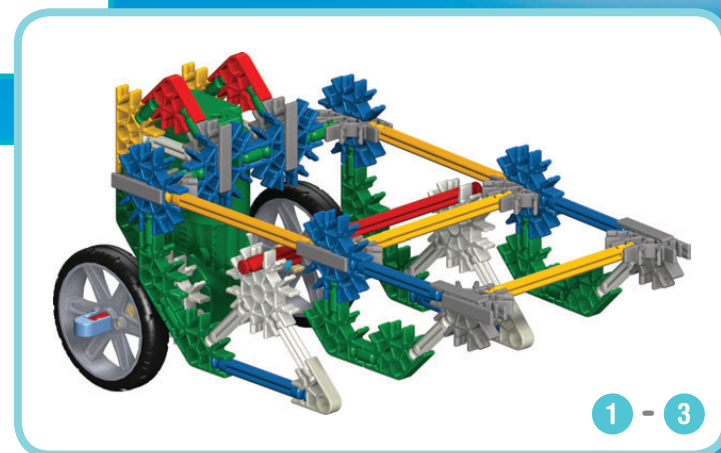
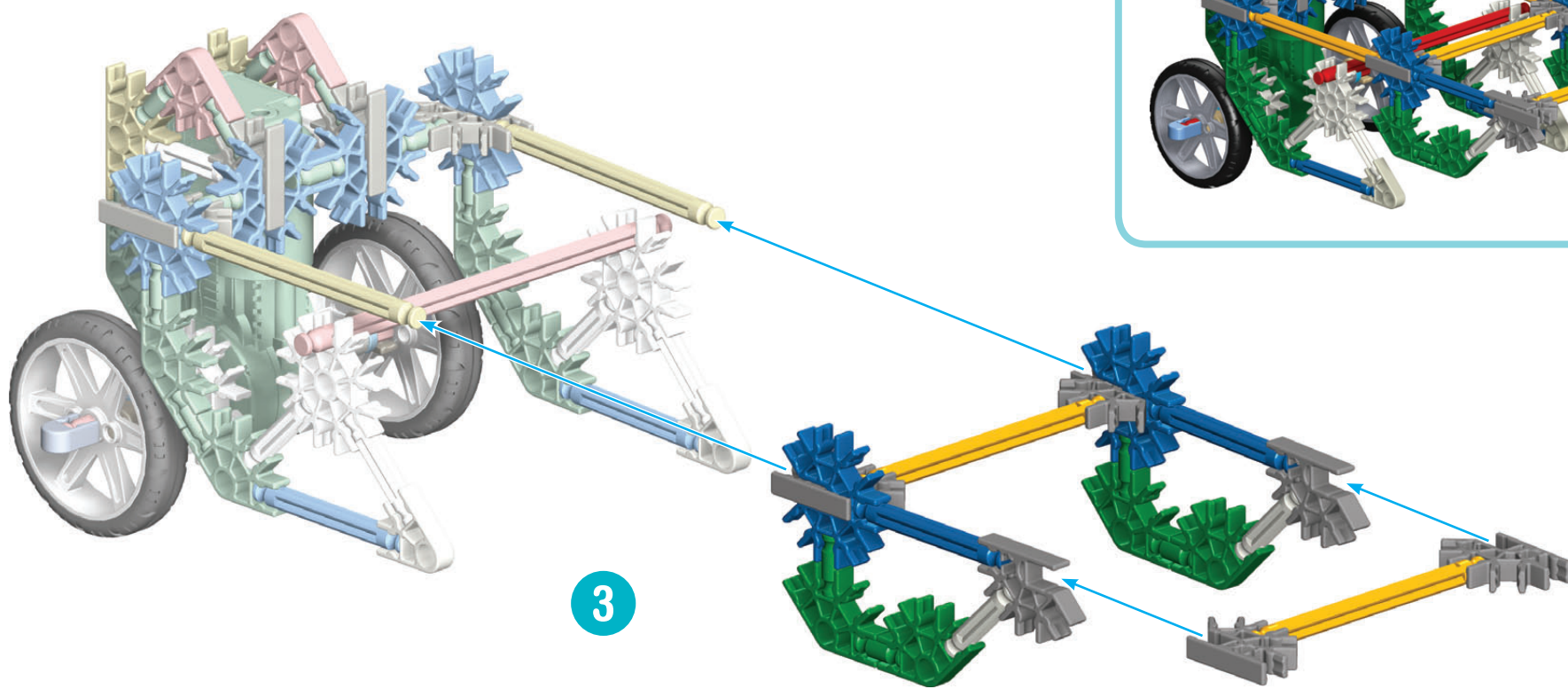
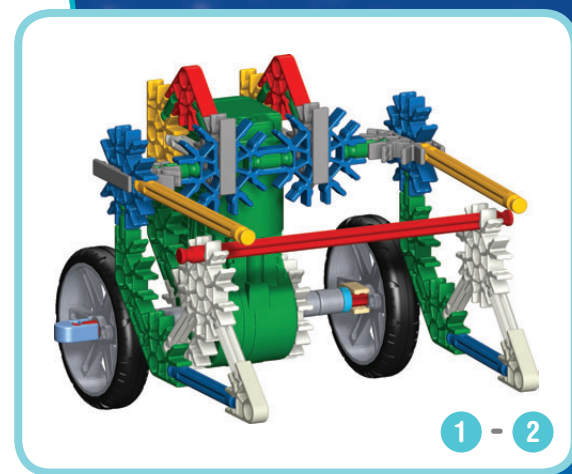
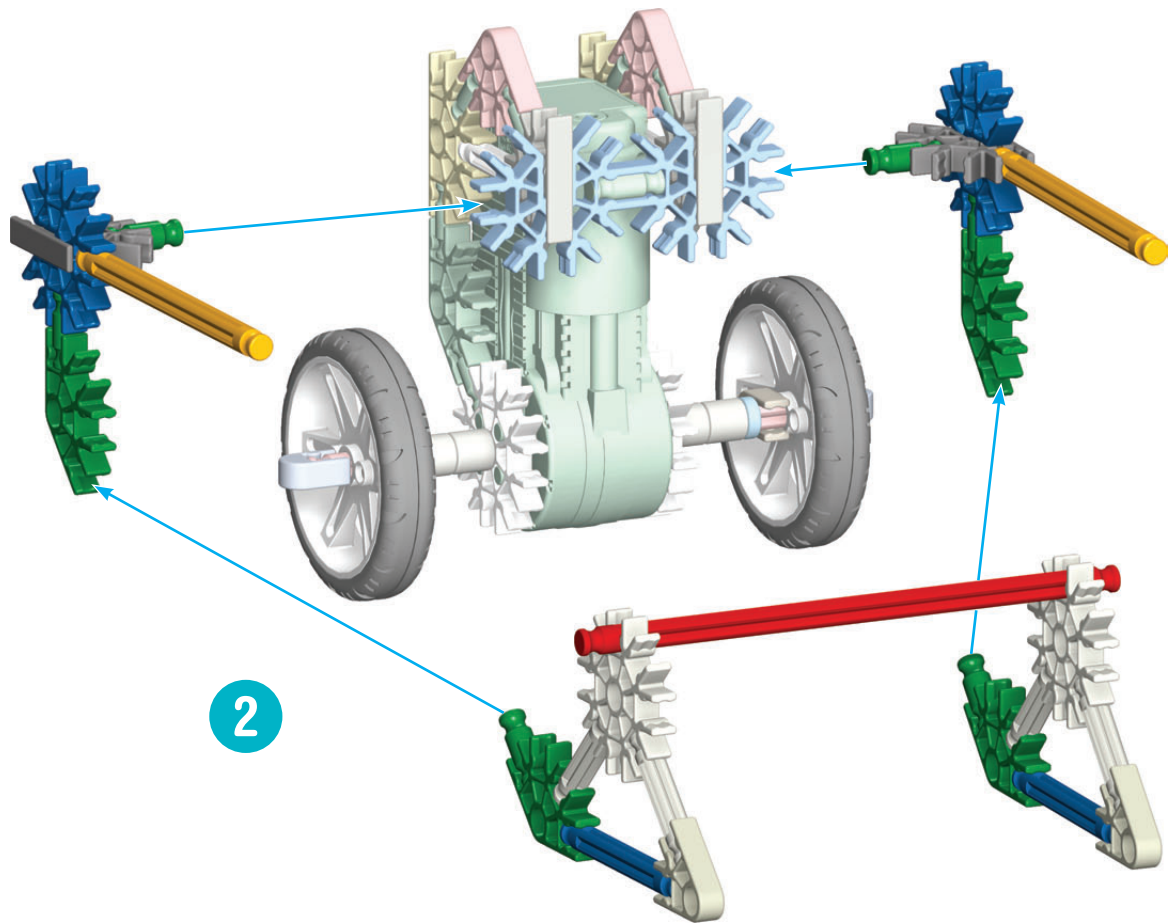

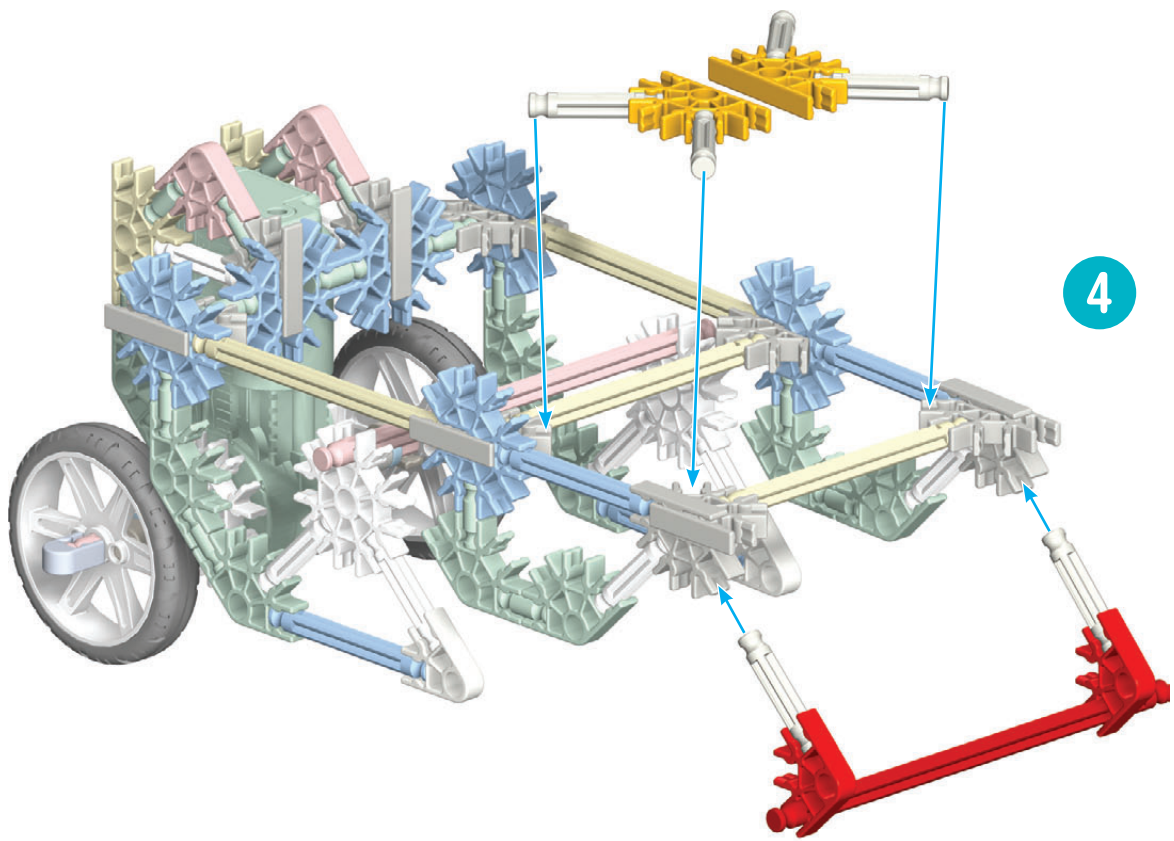

4



1 - 4

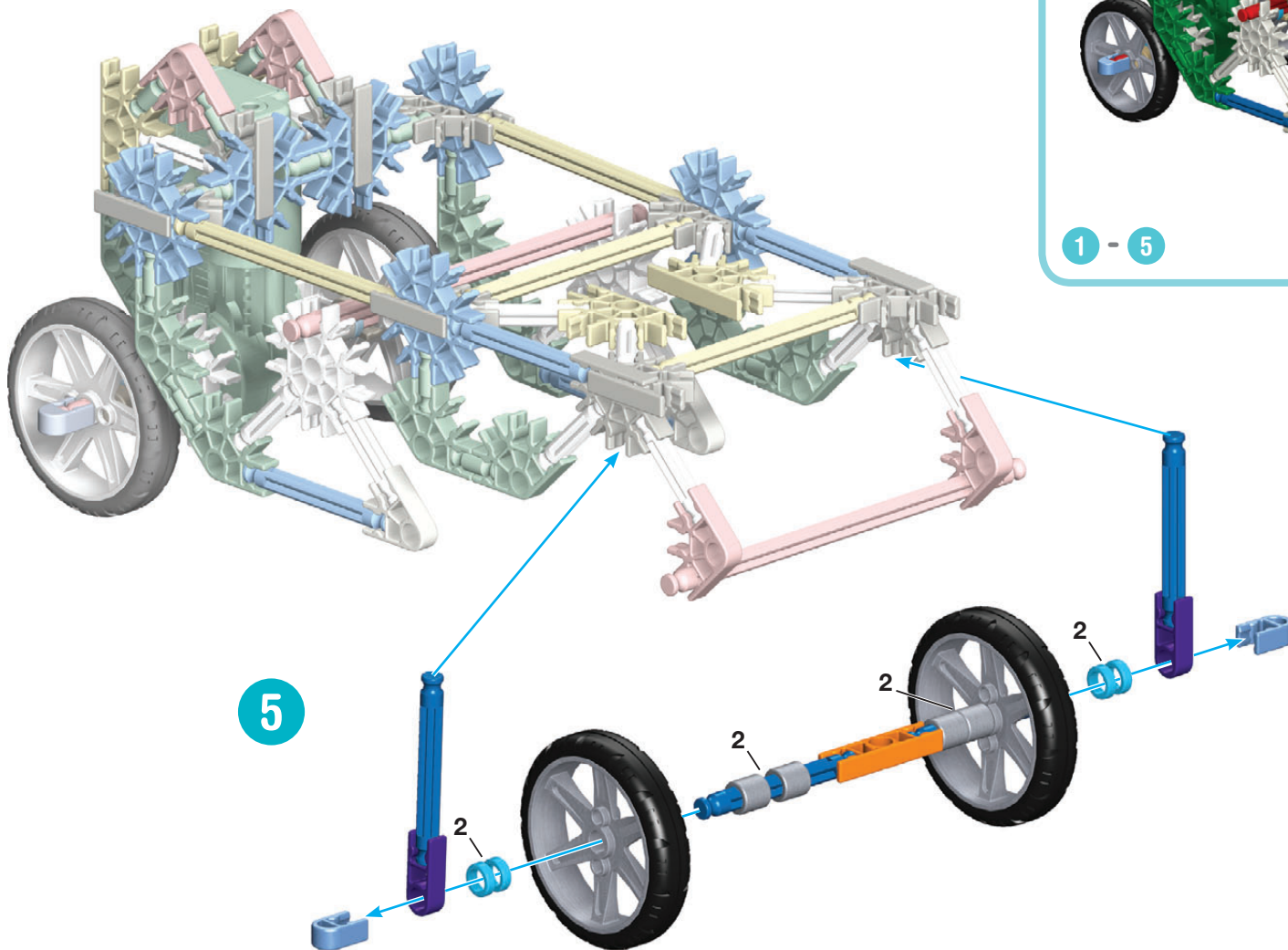

5



1 - 5

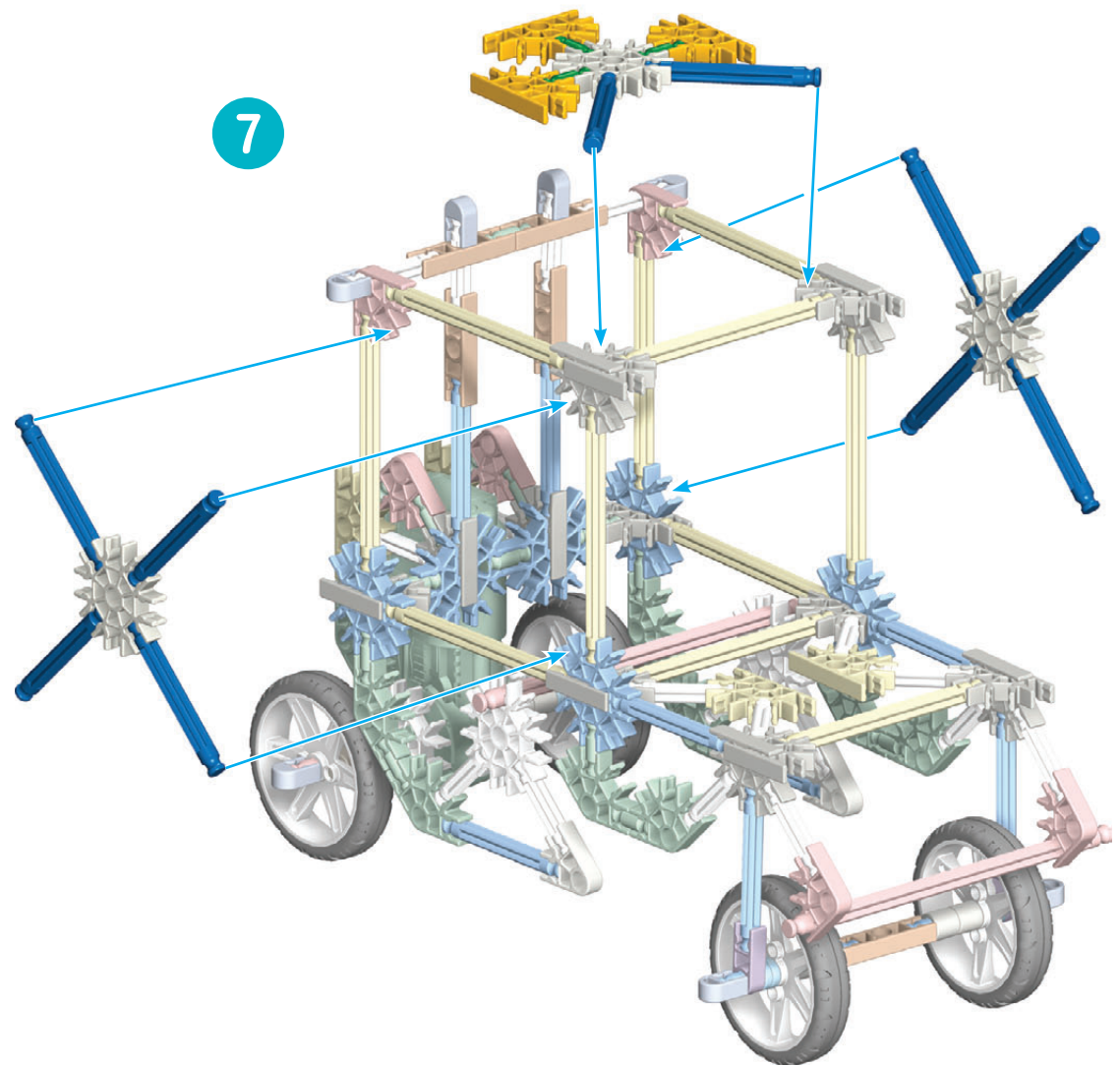
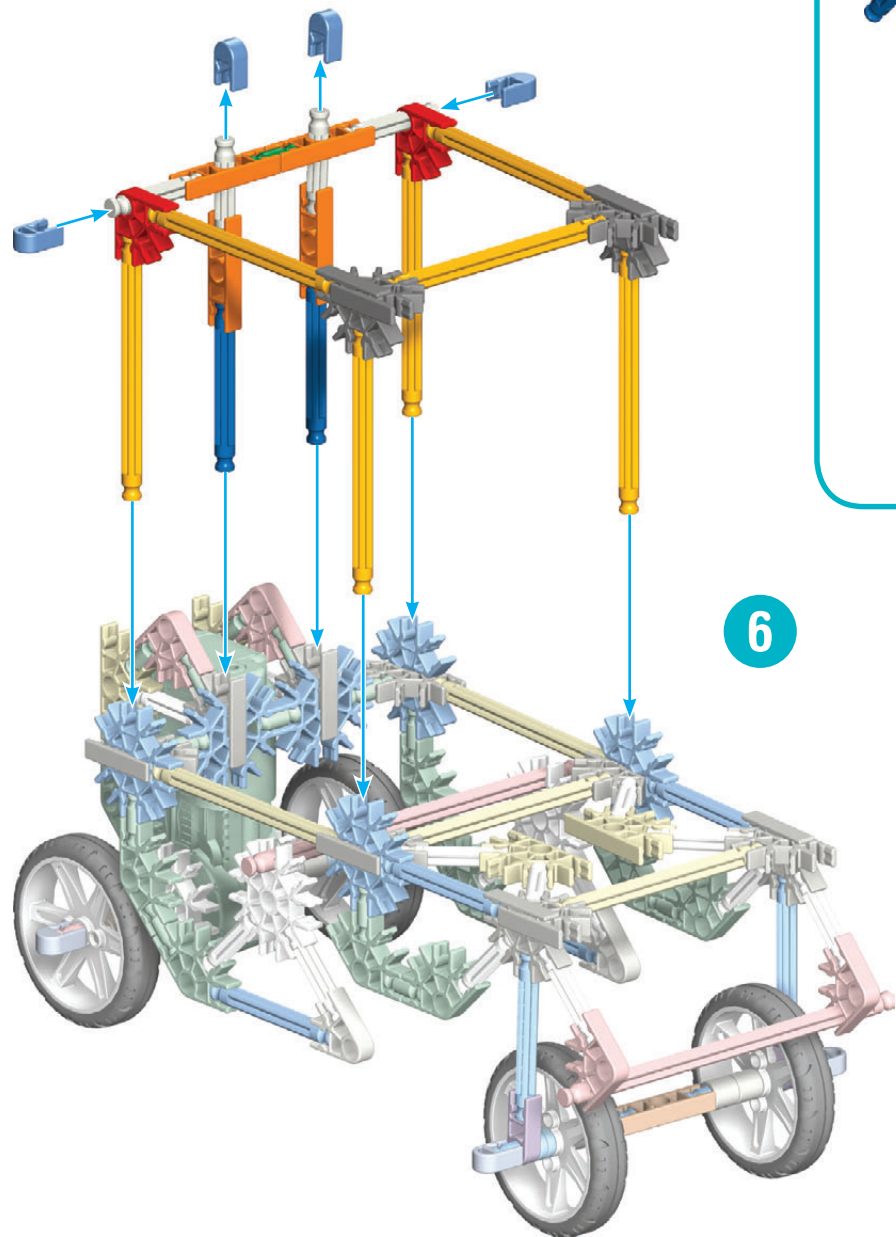

1

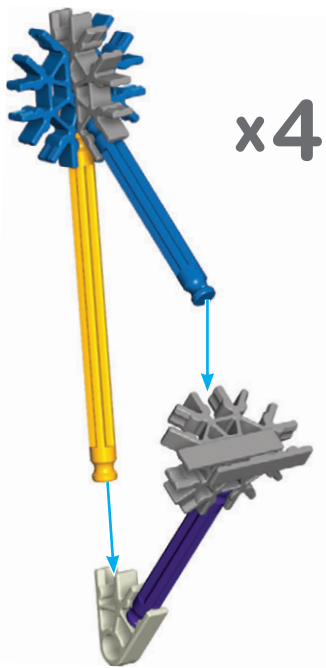

2

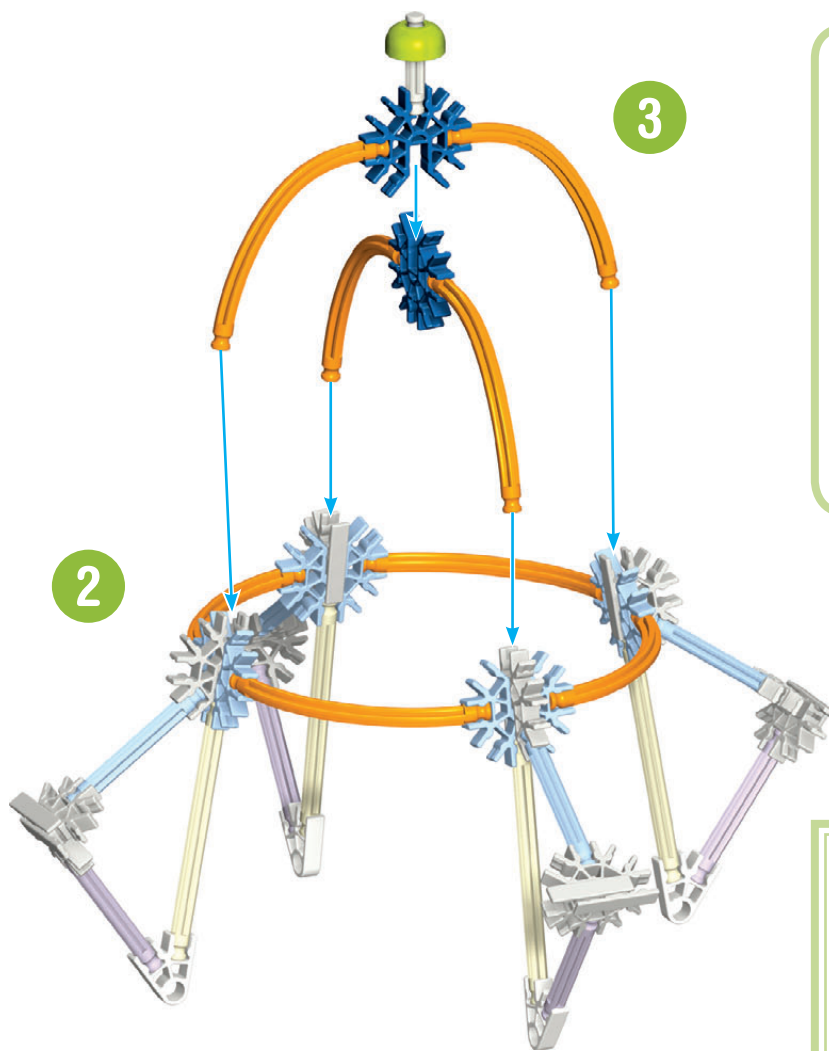

UFO
OVNI

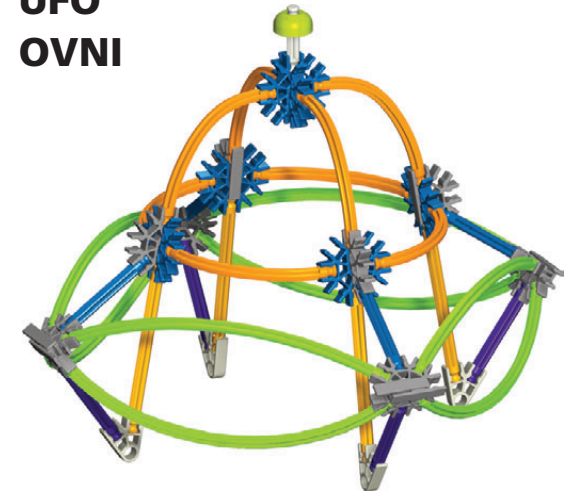

4

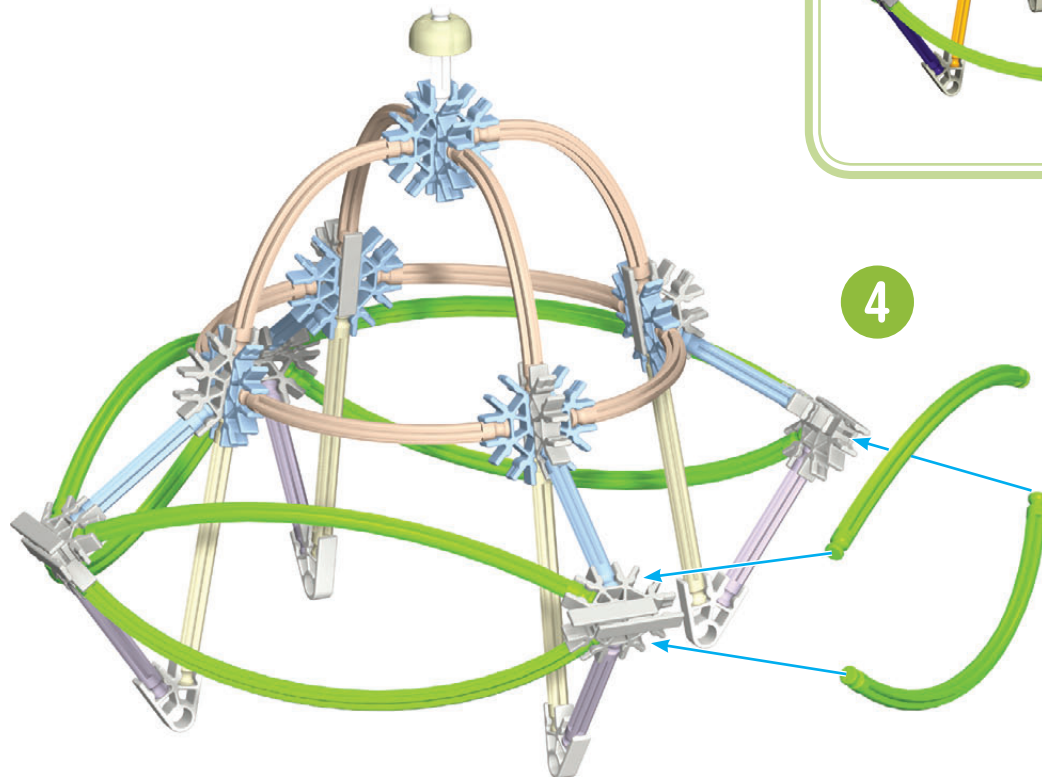

Windmill Moulin À Vent

1

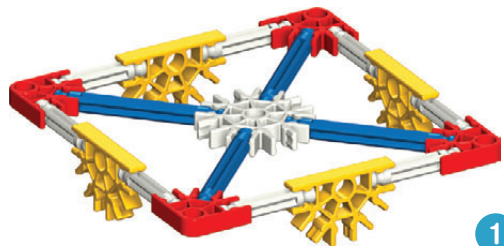
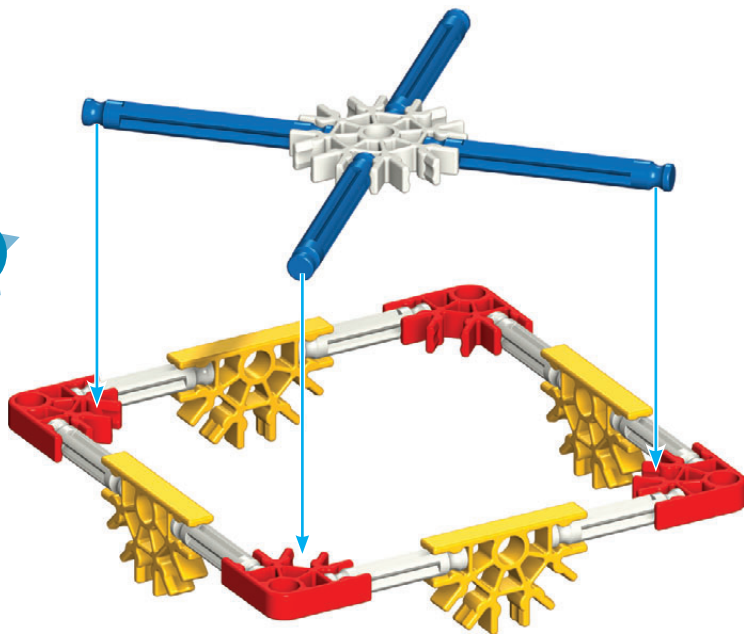

1

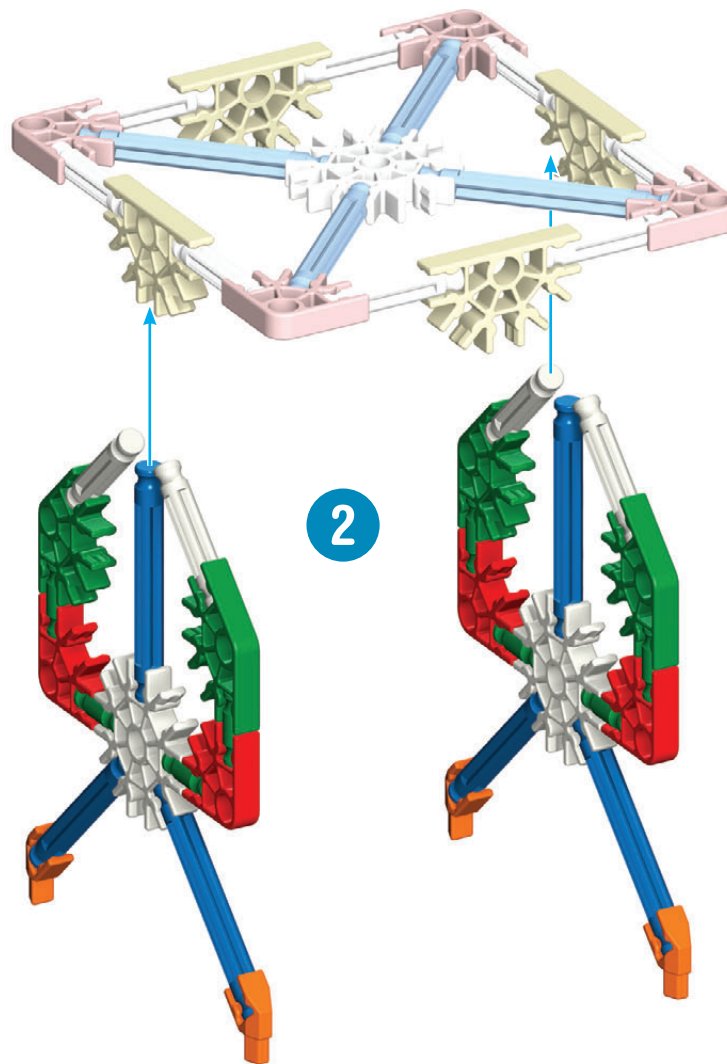

2



1 - 2

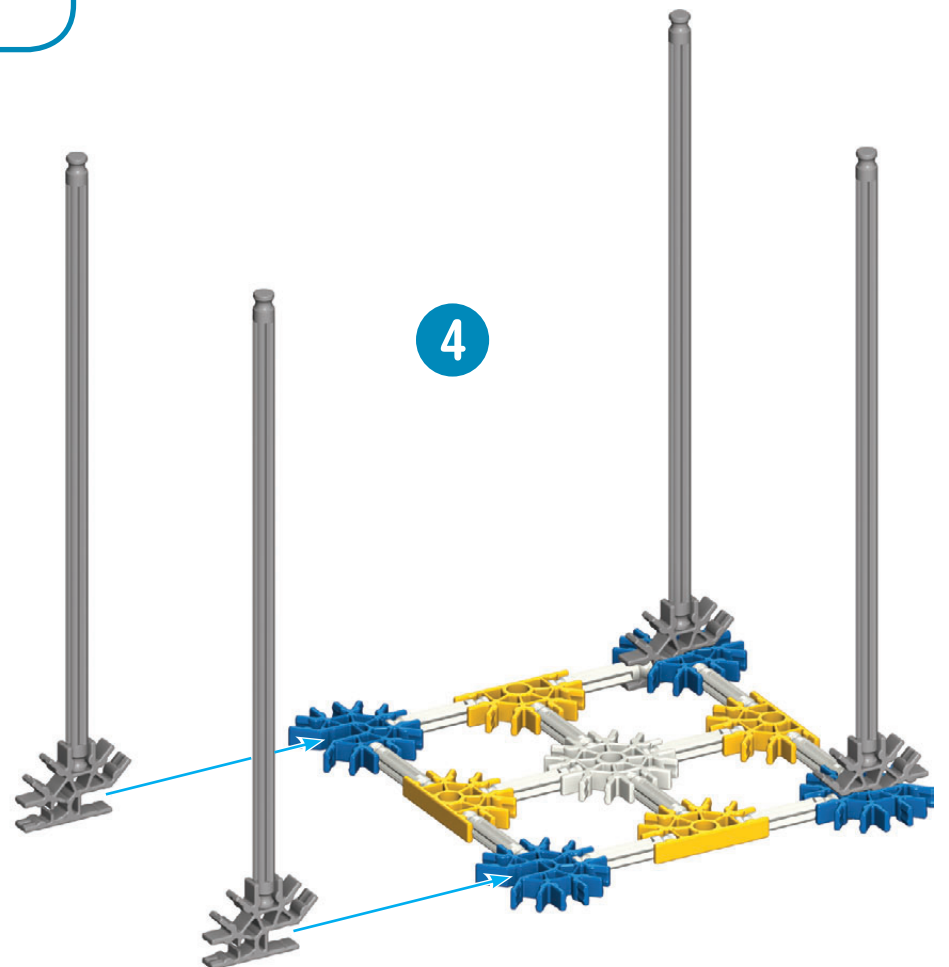
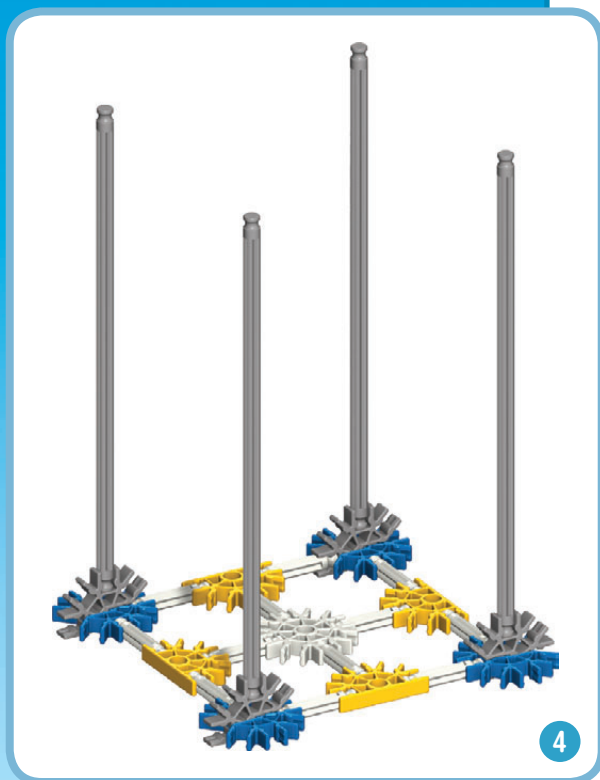
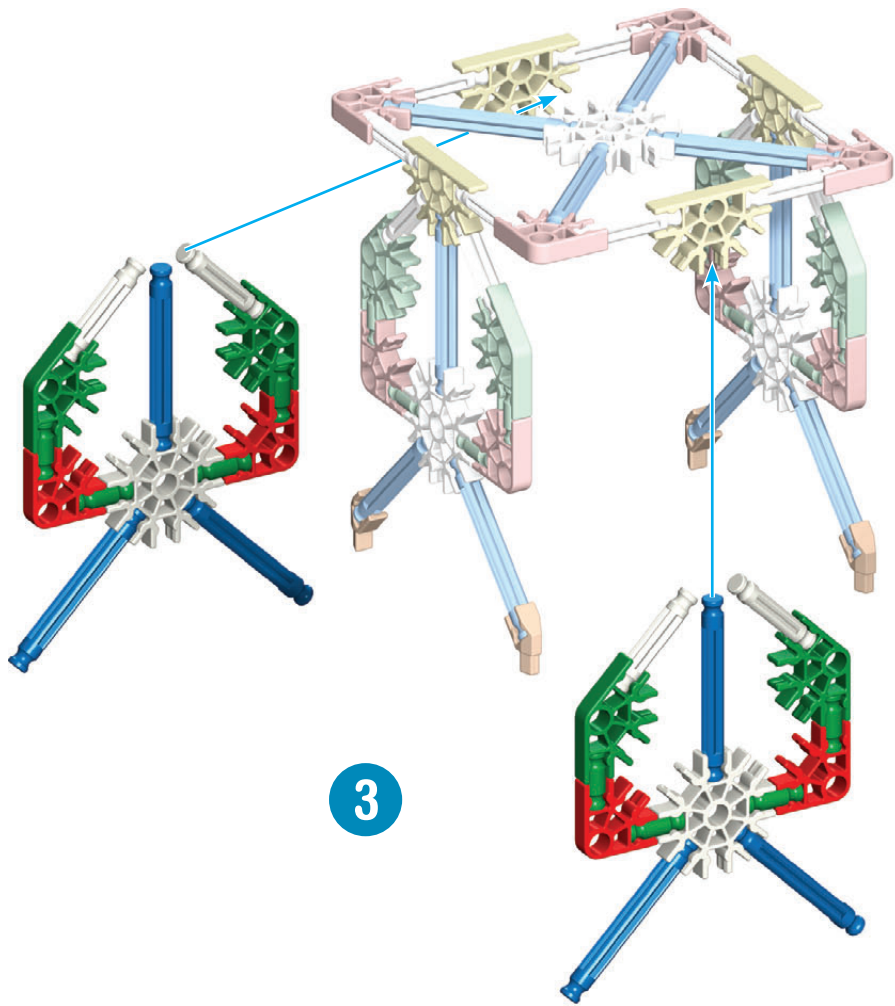

5

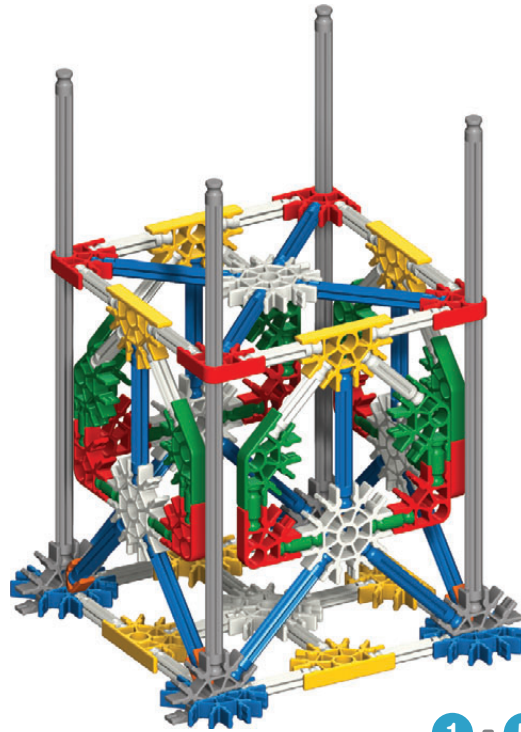
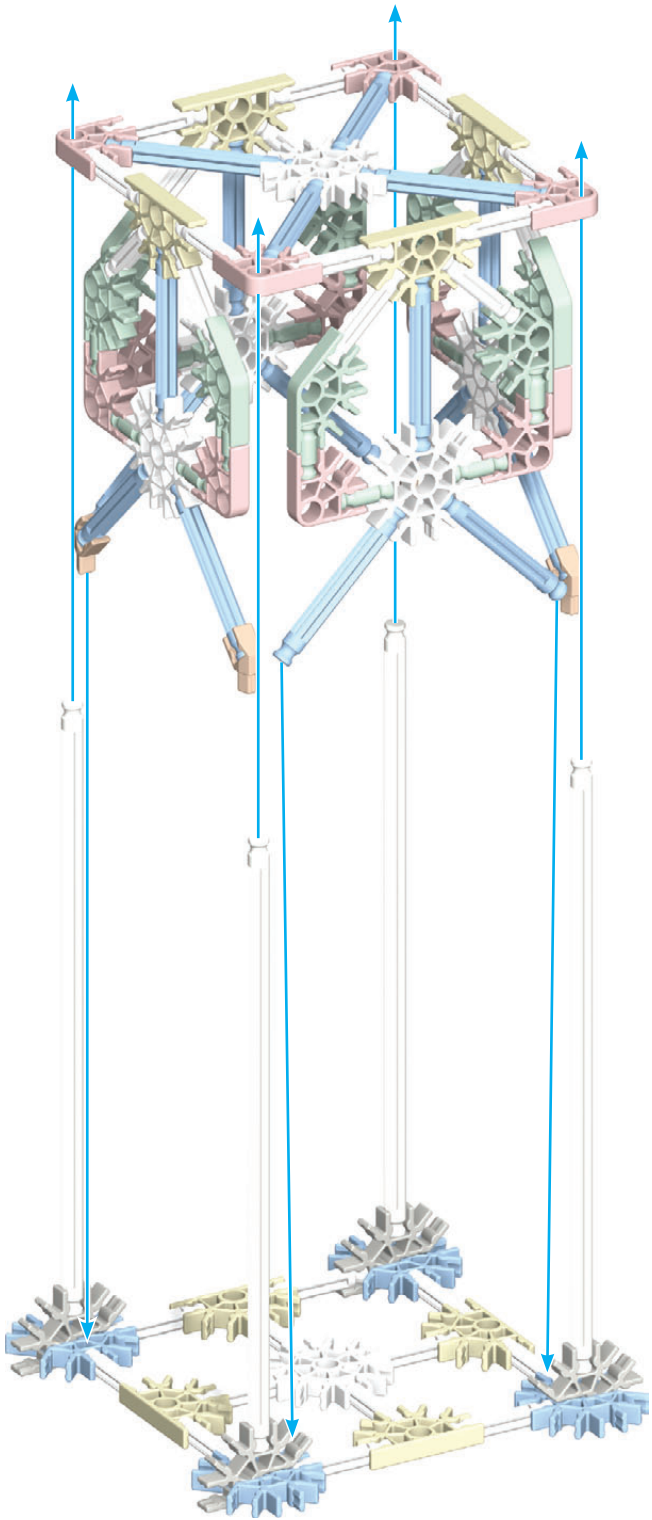

1 - 5



6

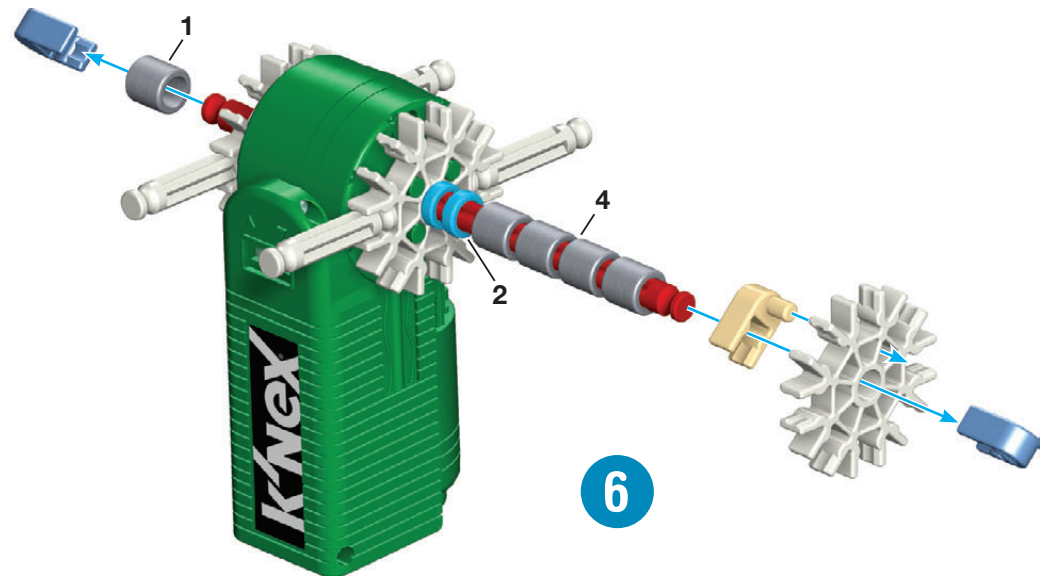

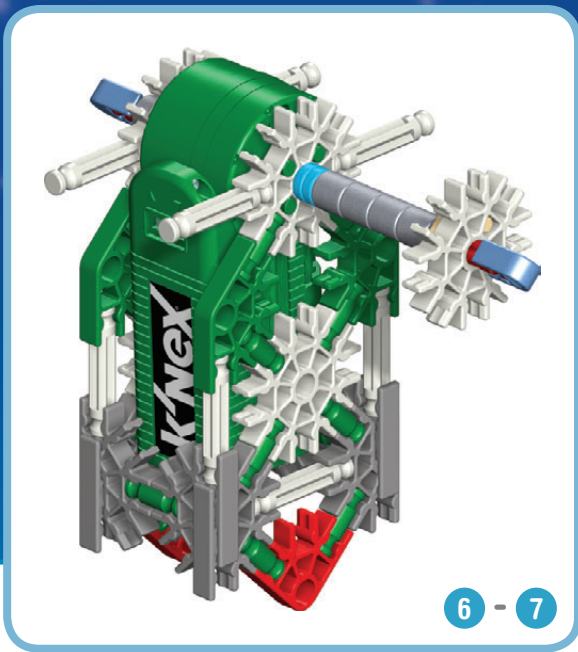

6 - 7

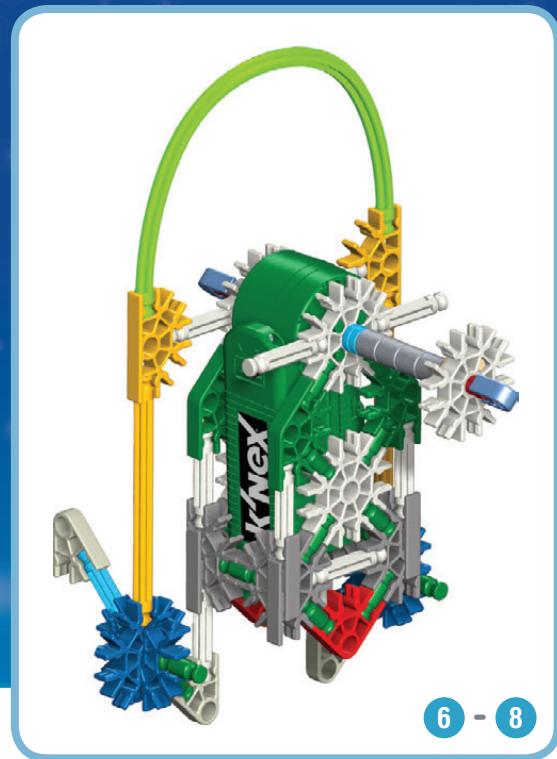

6 - 8

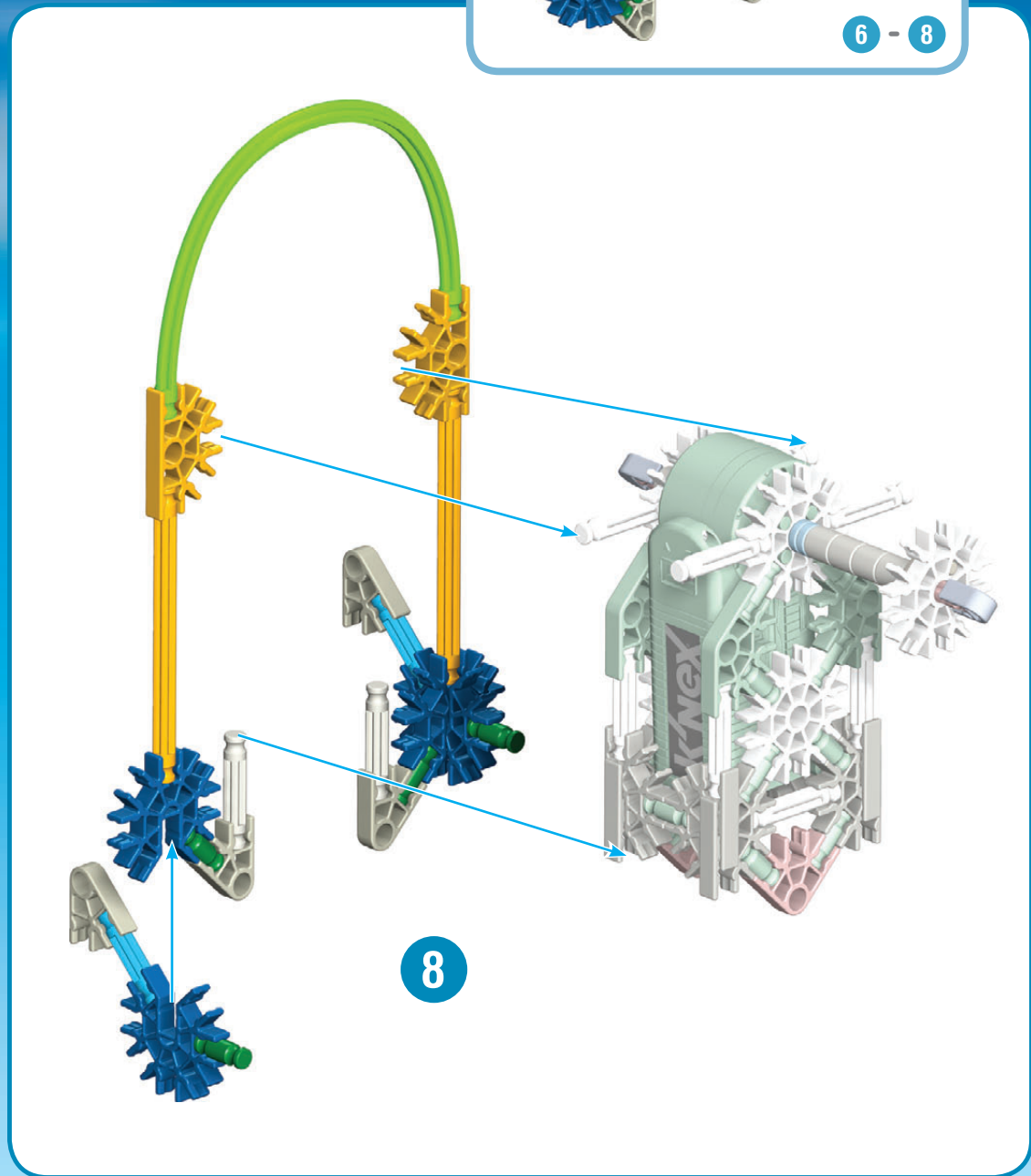
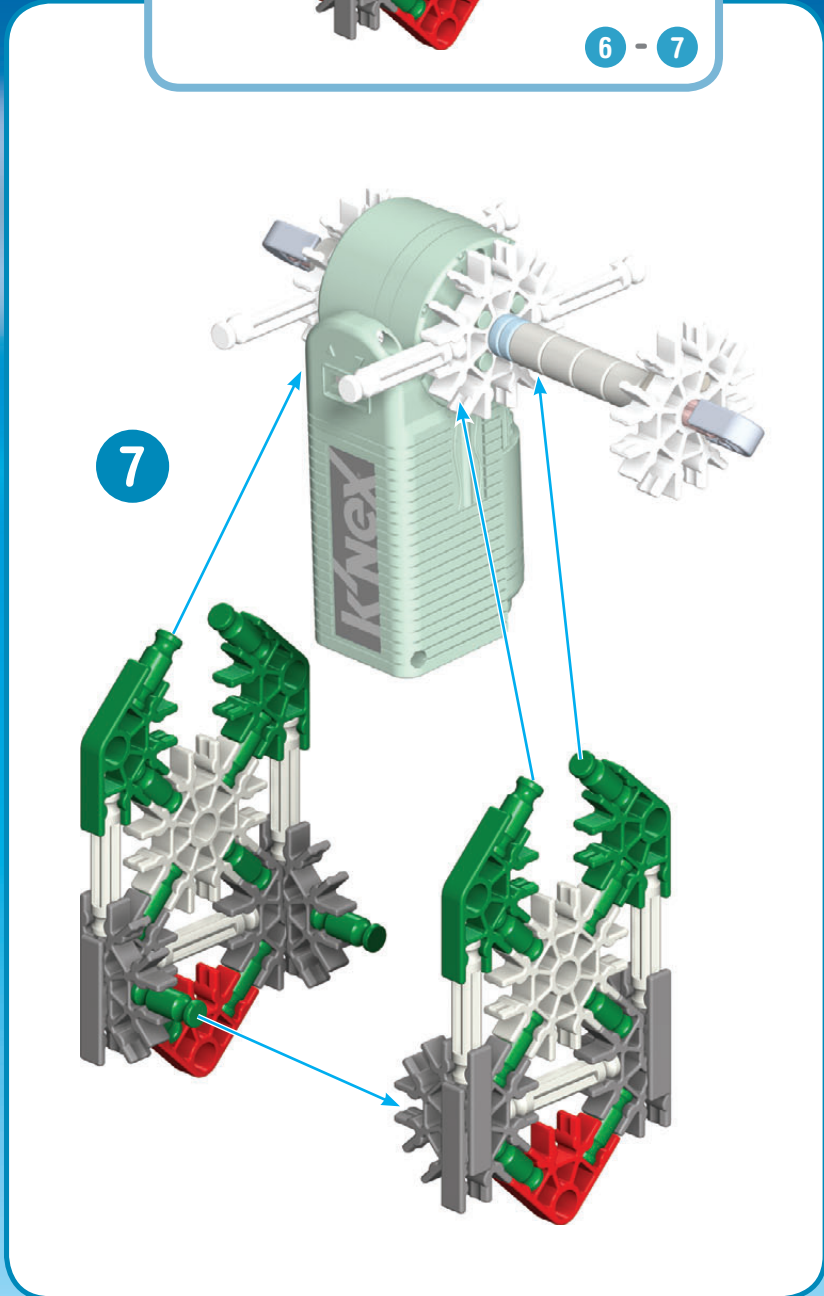

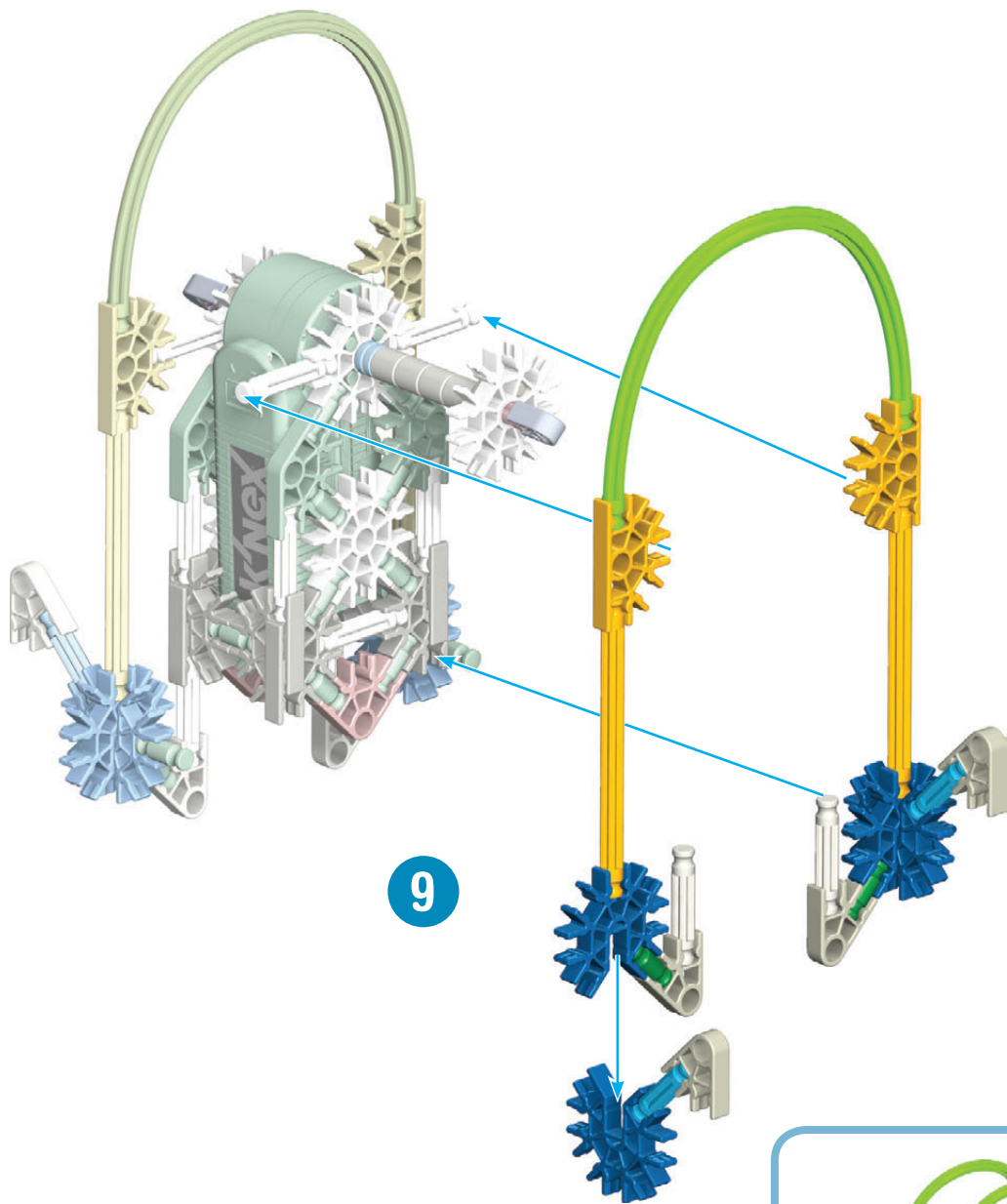

9

10

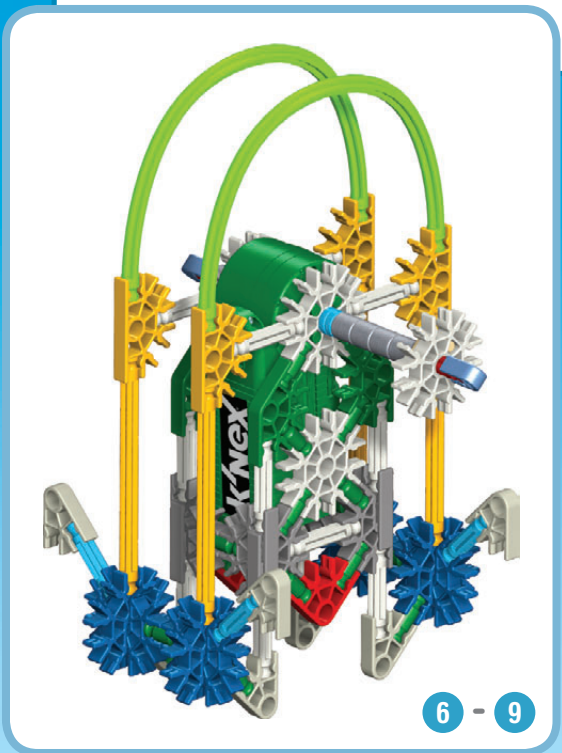
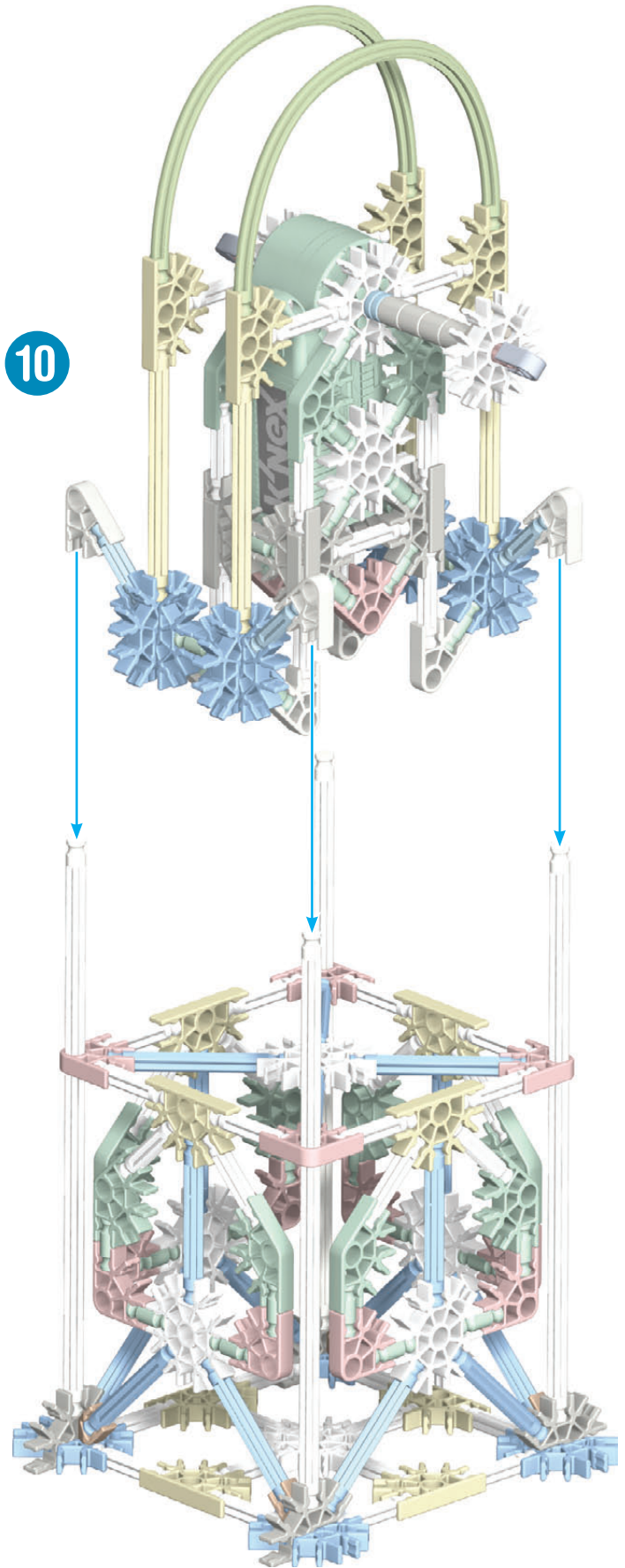

6 - 9

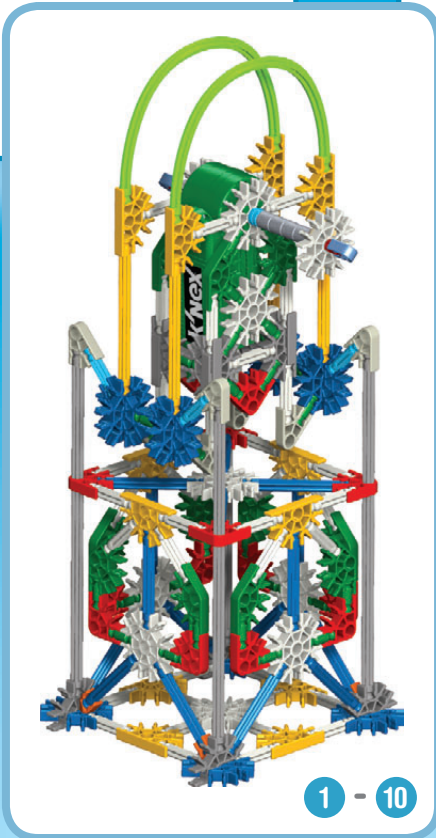

1 - 10

11

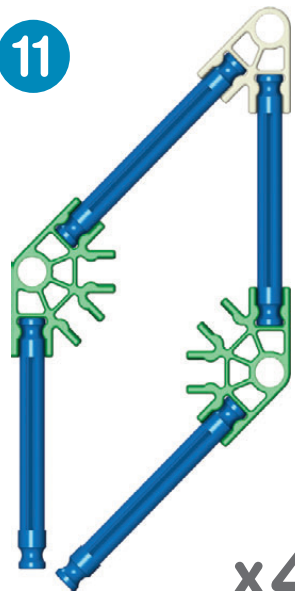

x4

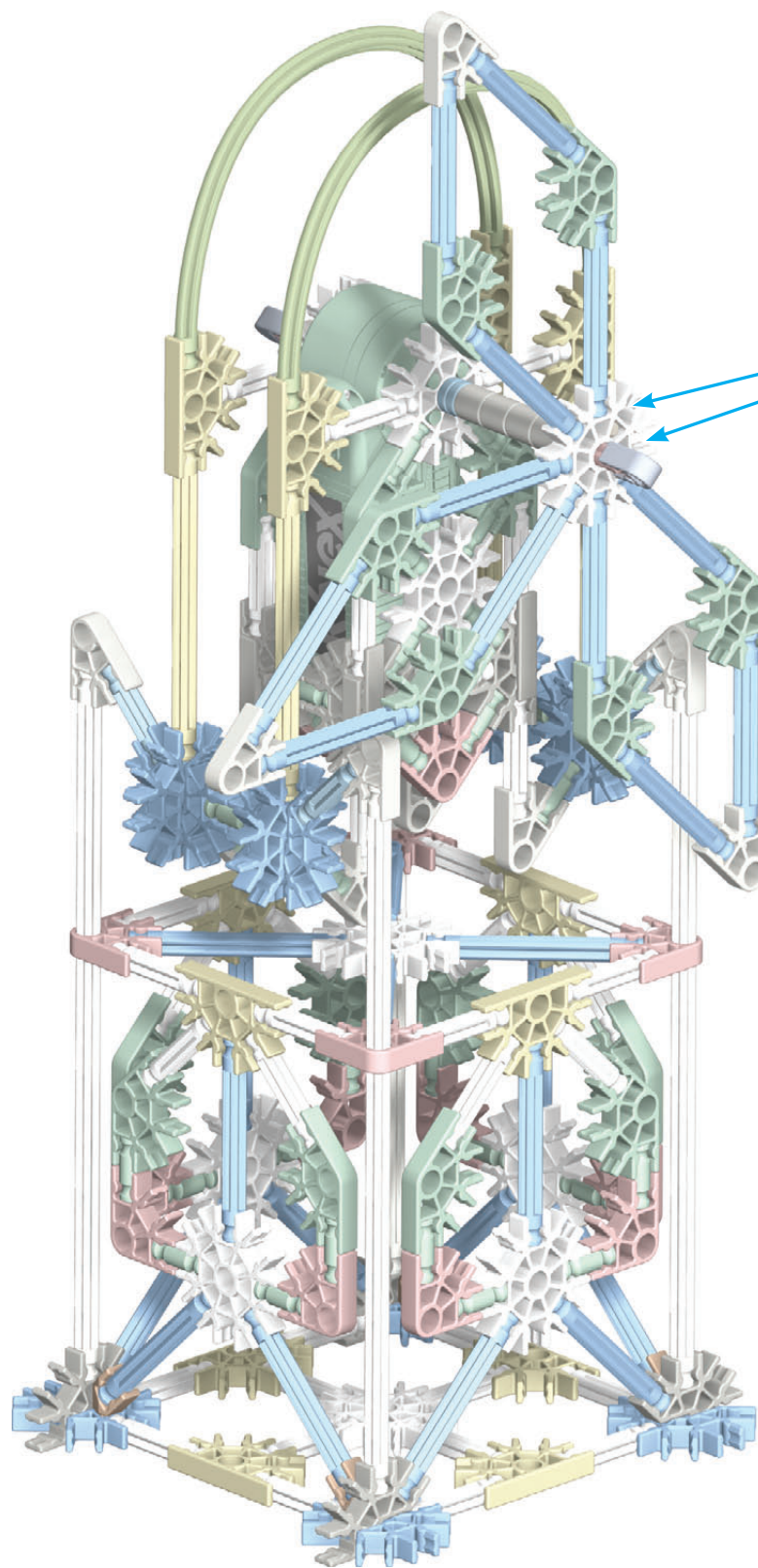

12



1 - 12

Birthday Cake Gâteau D'Anniversaire

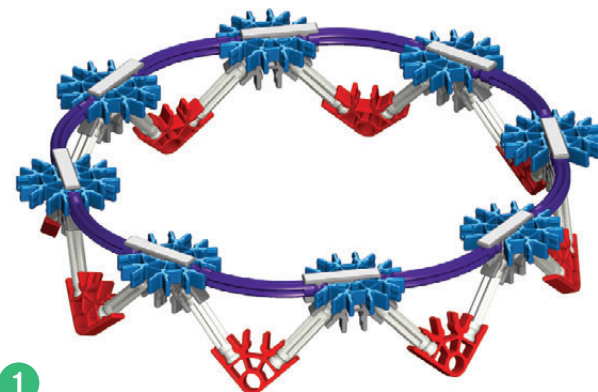
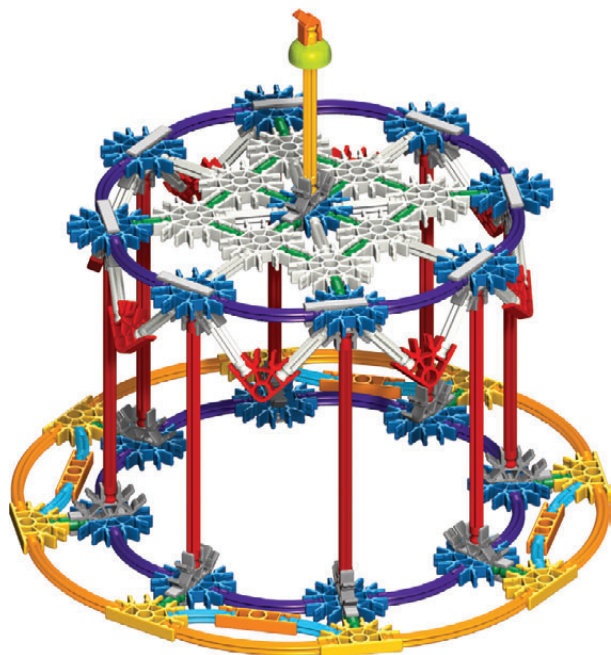

1

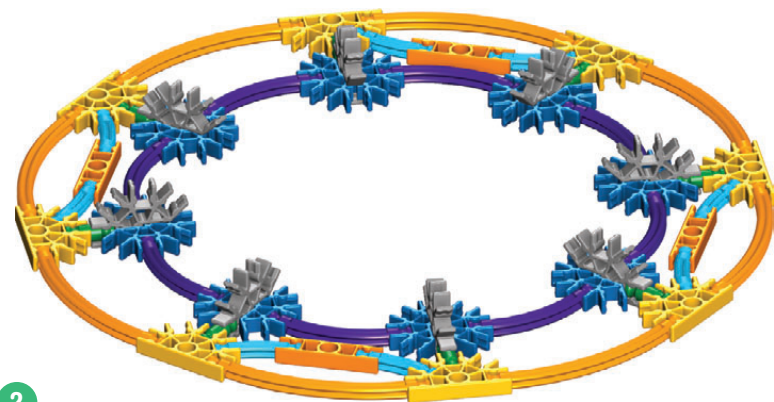
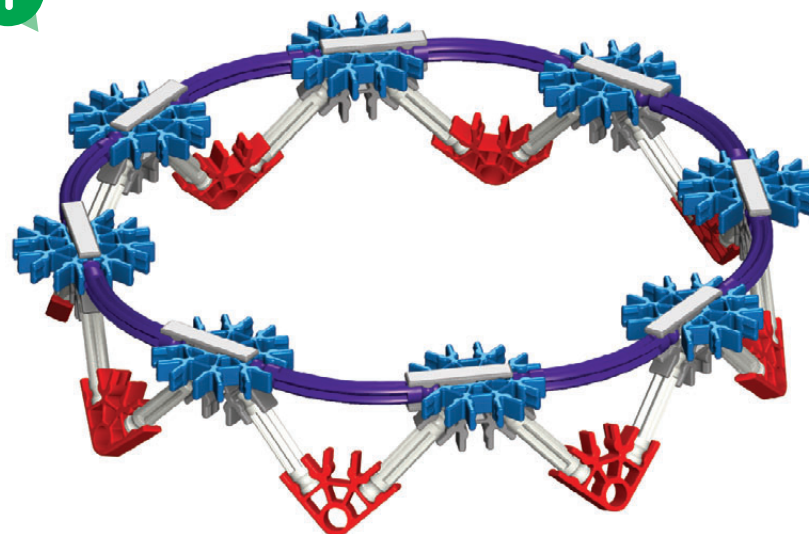

2

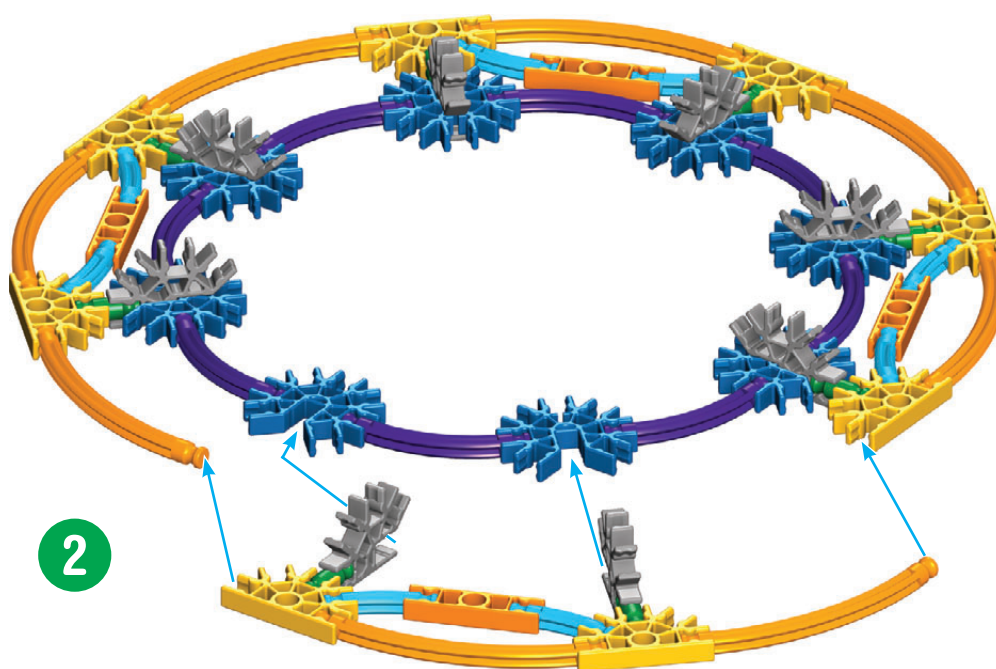

2

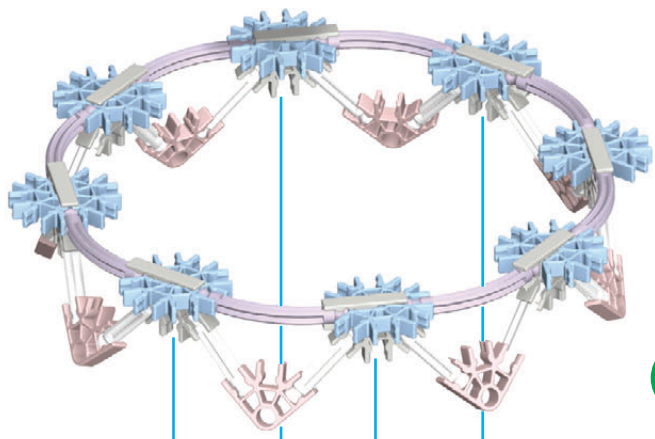

4

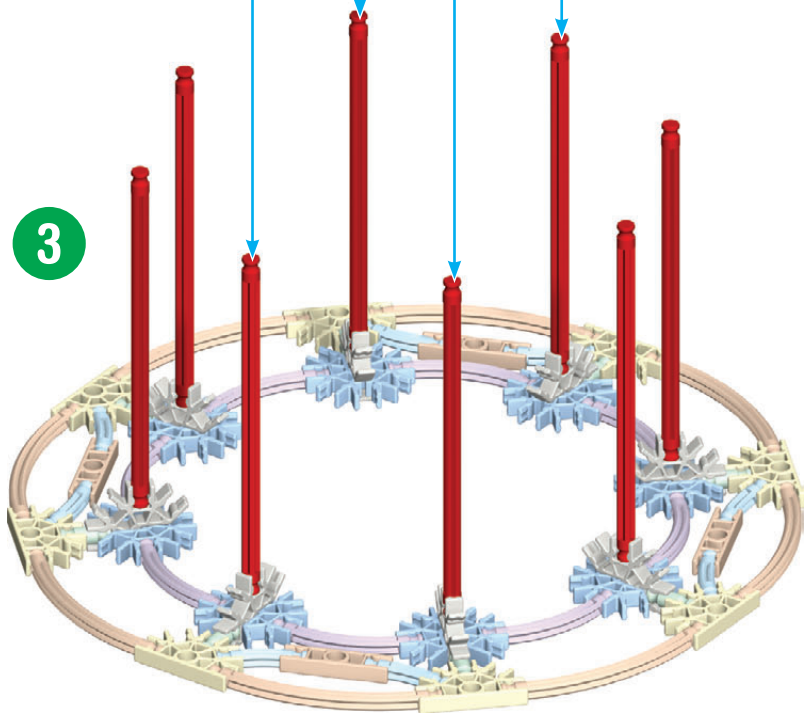

3

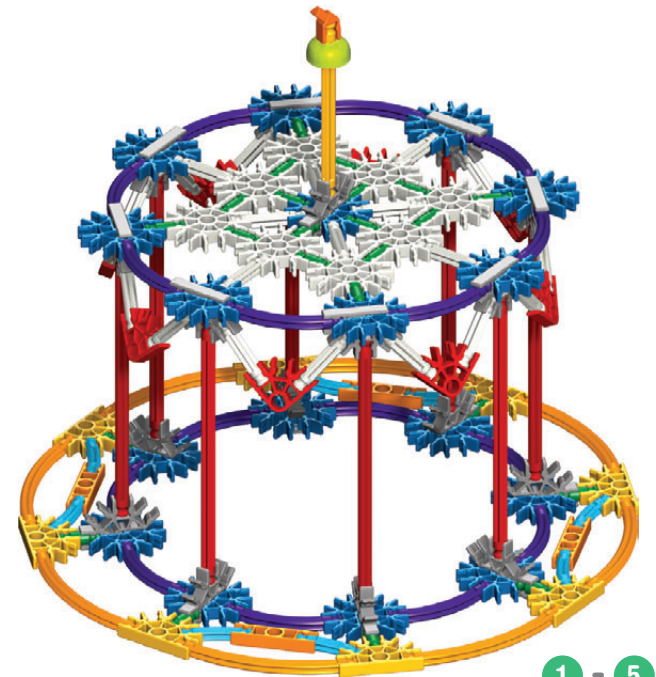

1 - 5

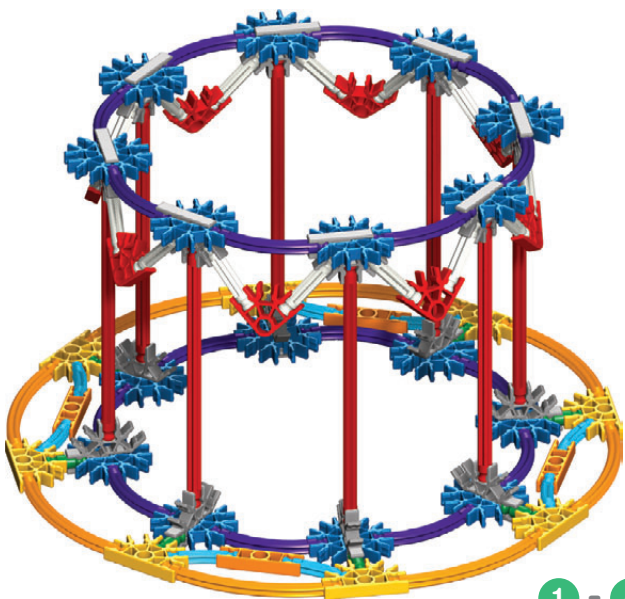

1 - 4

5

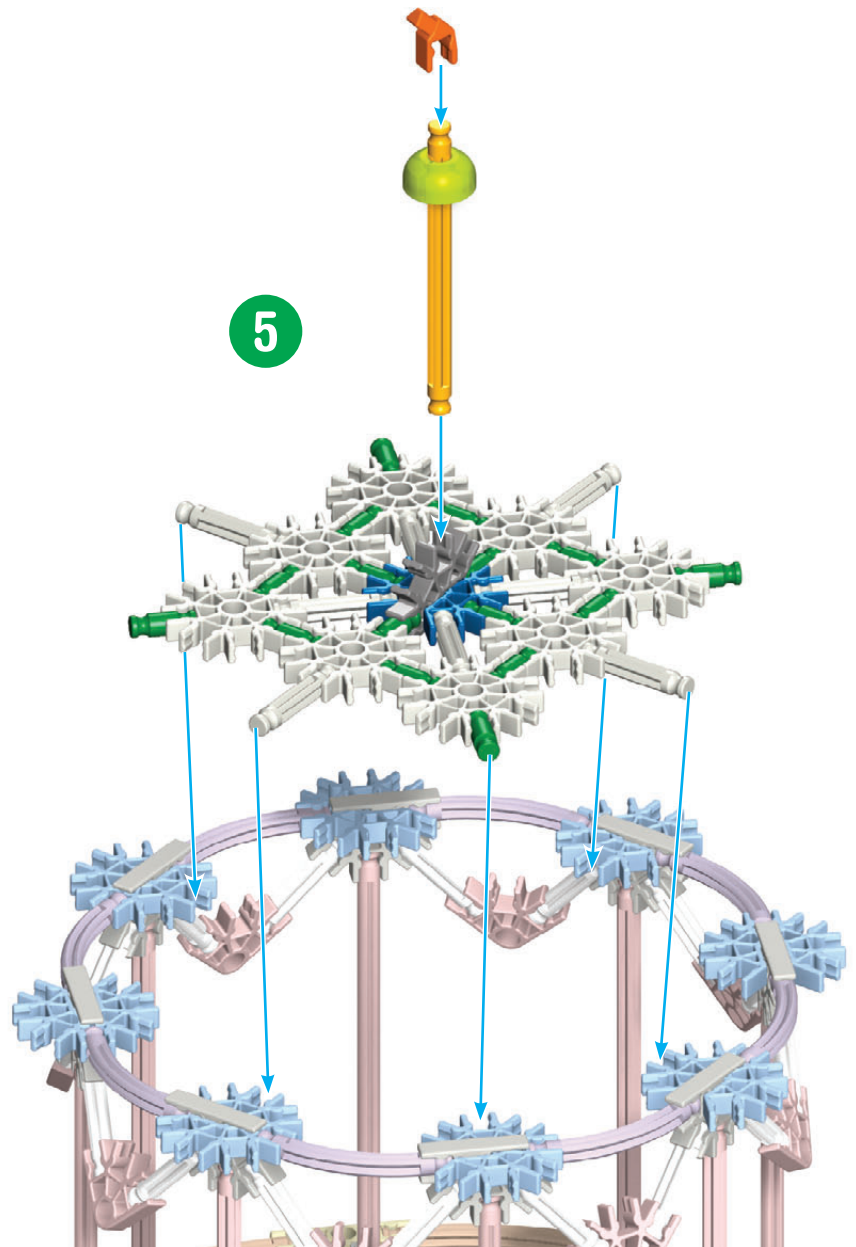

Locomotive Locomotive

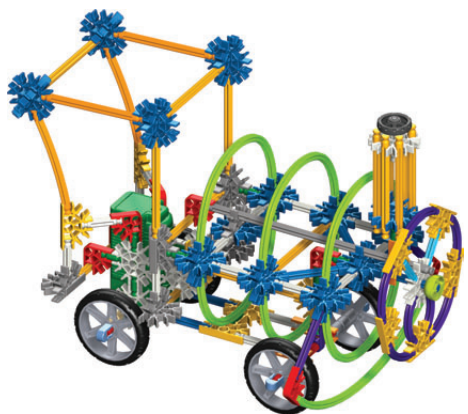

1

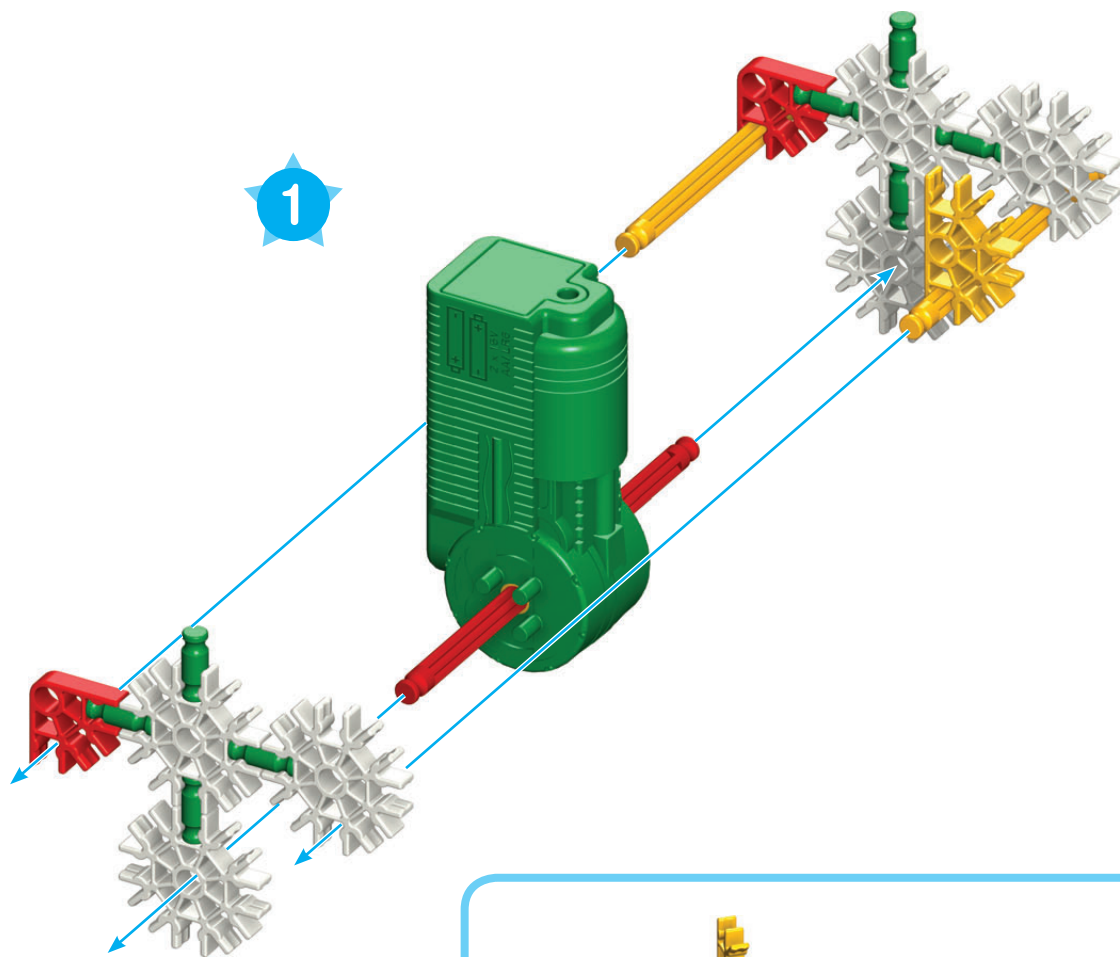

1



1 - 2

2

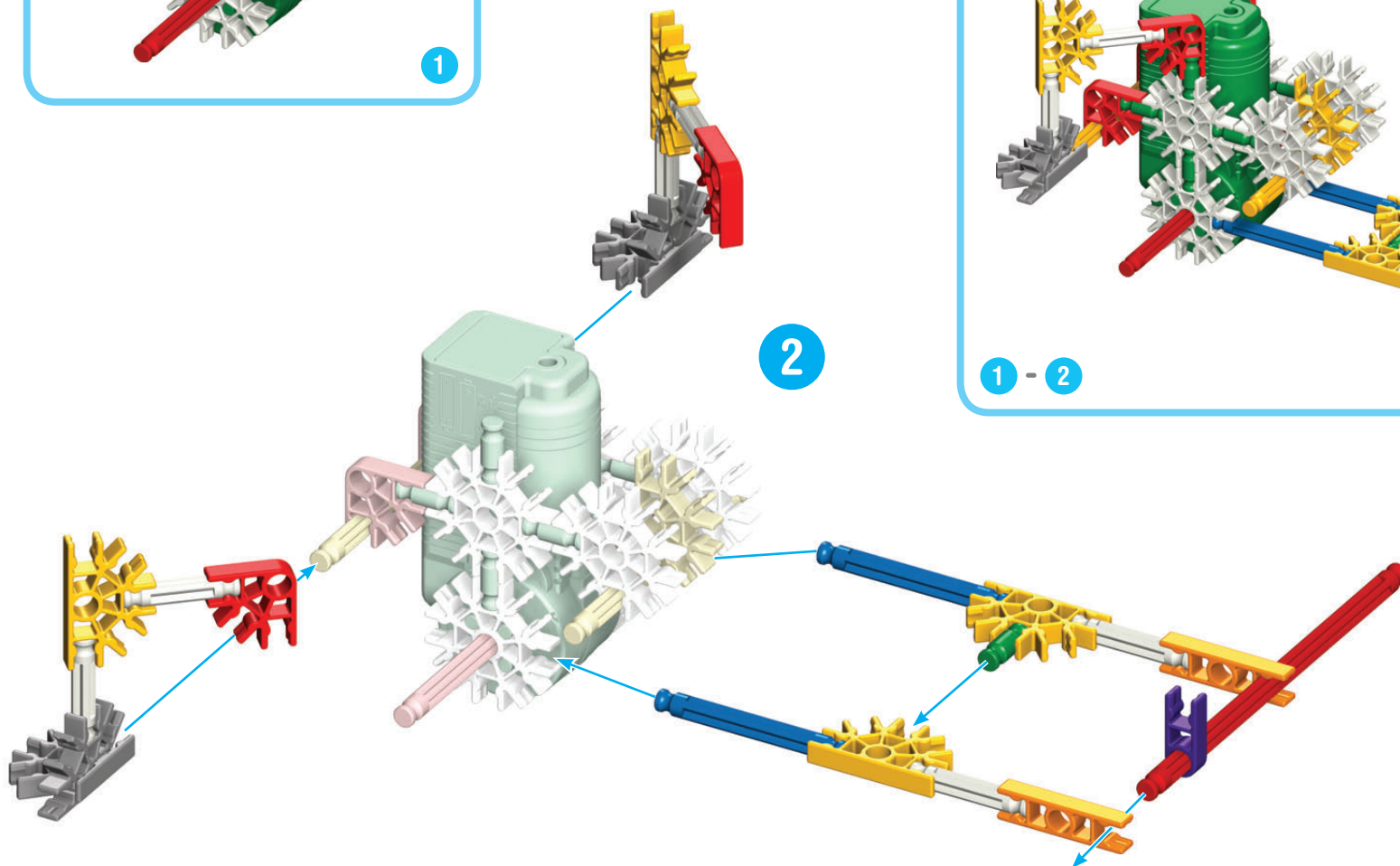

3

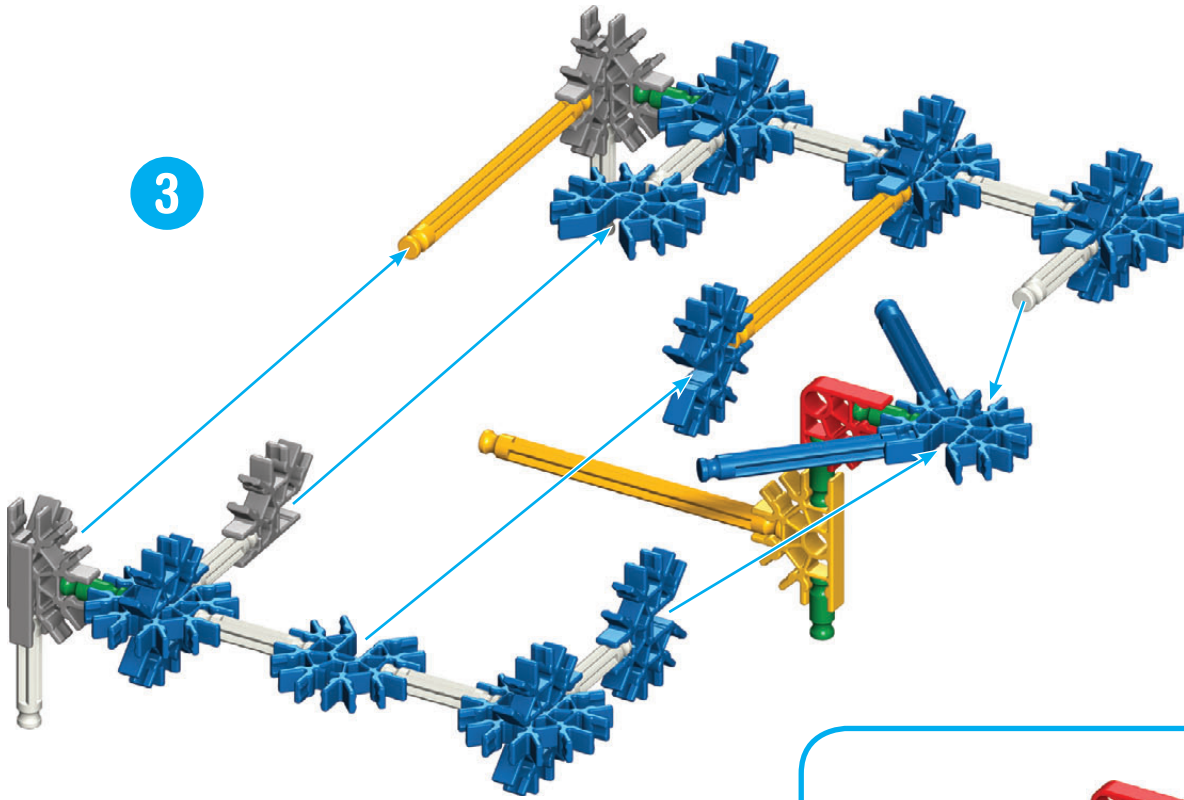

3

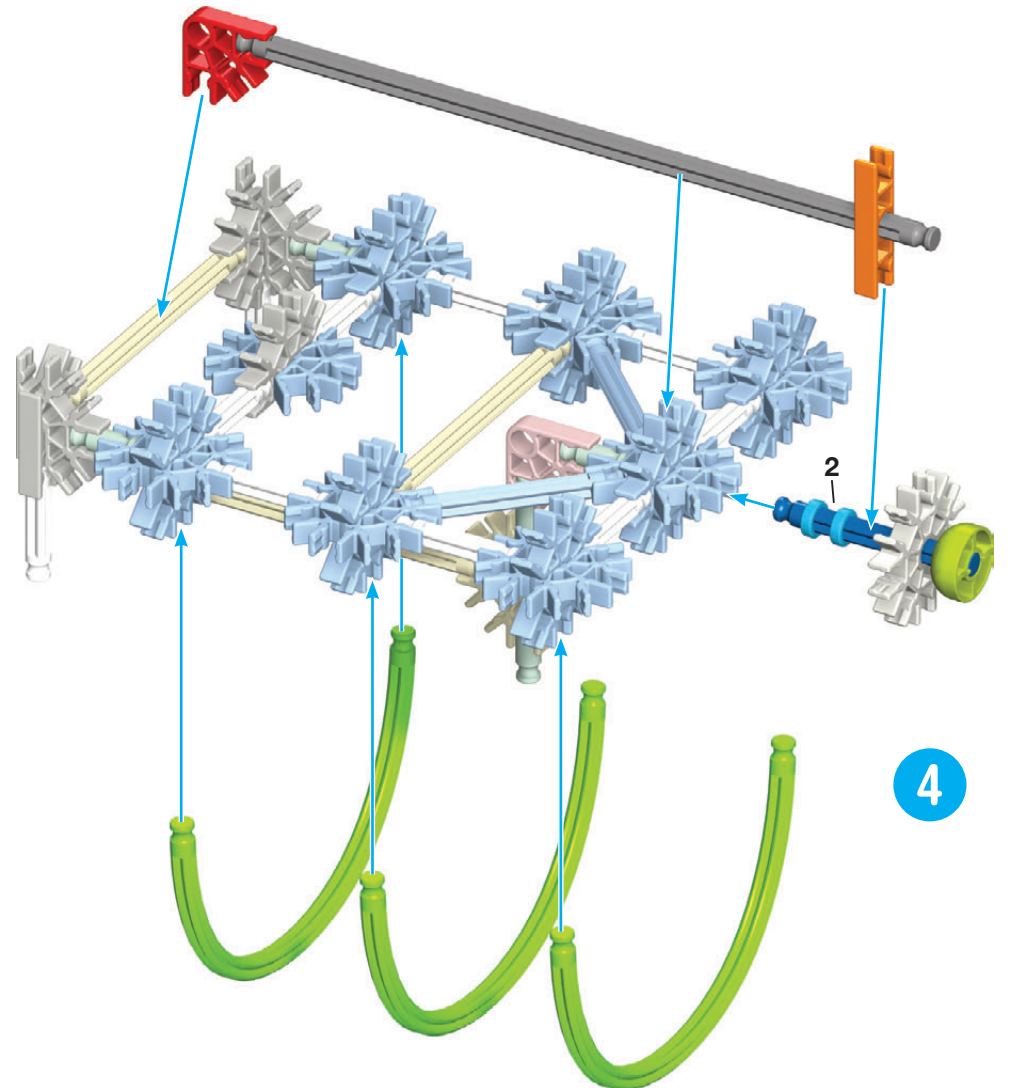
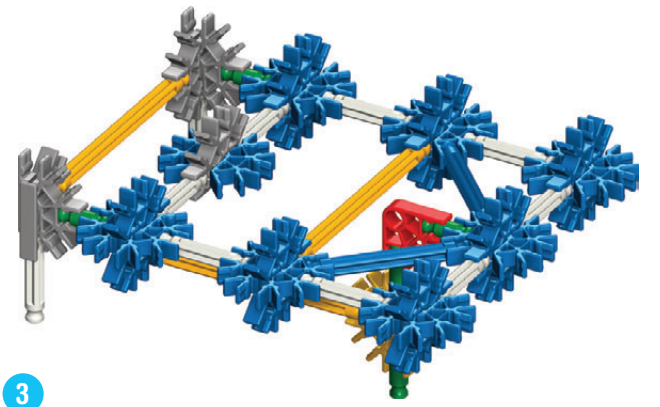

4

3 - 4

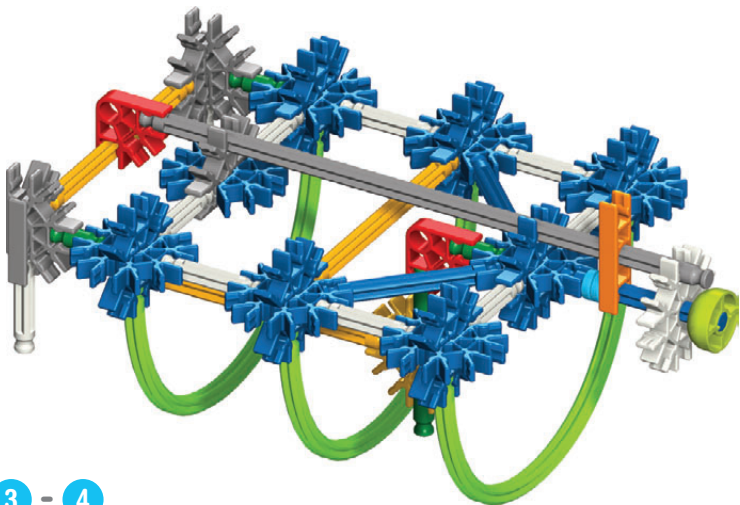

5

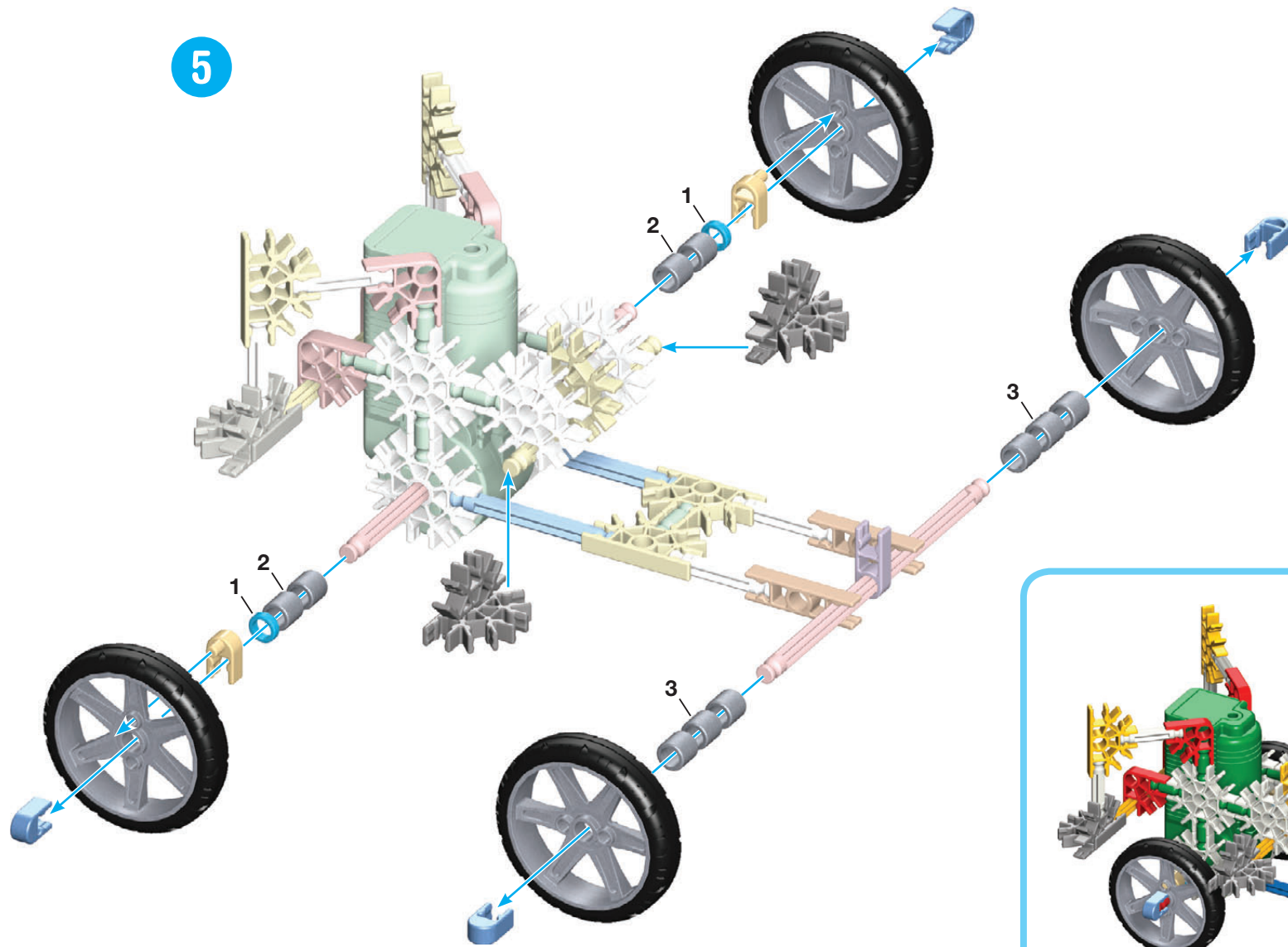

6

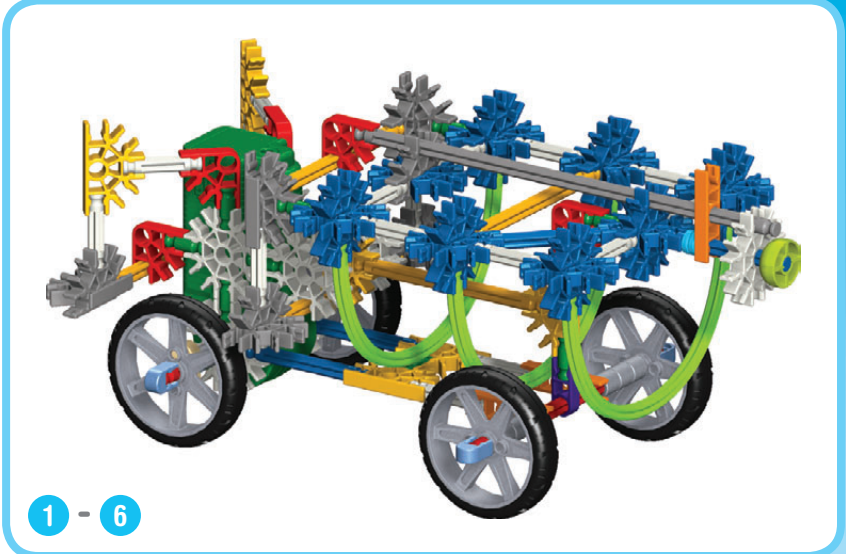
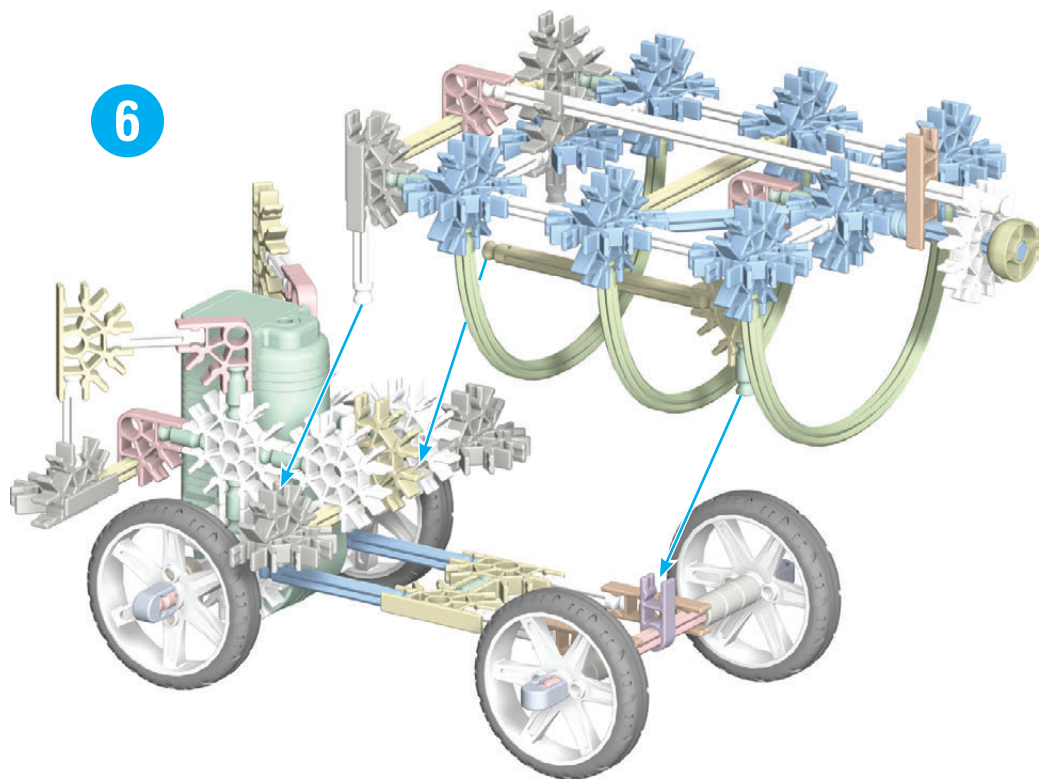

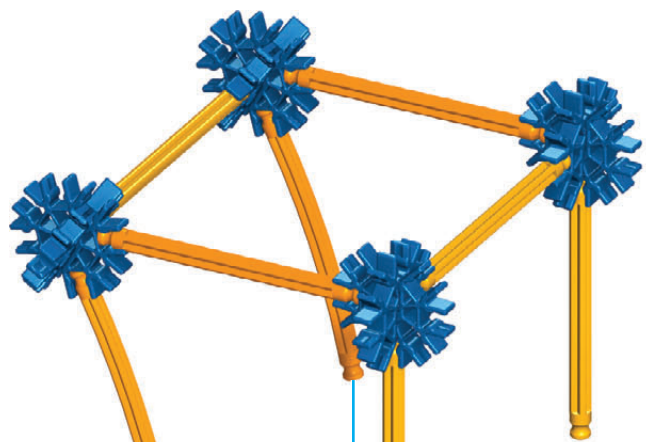

7

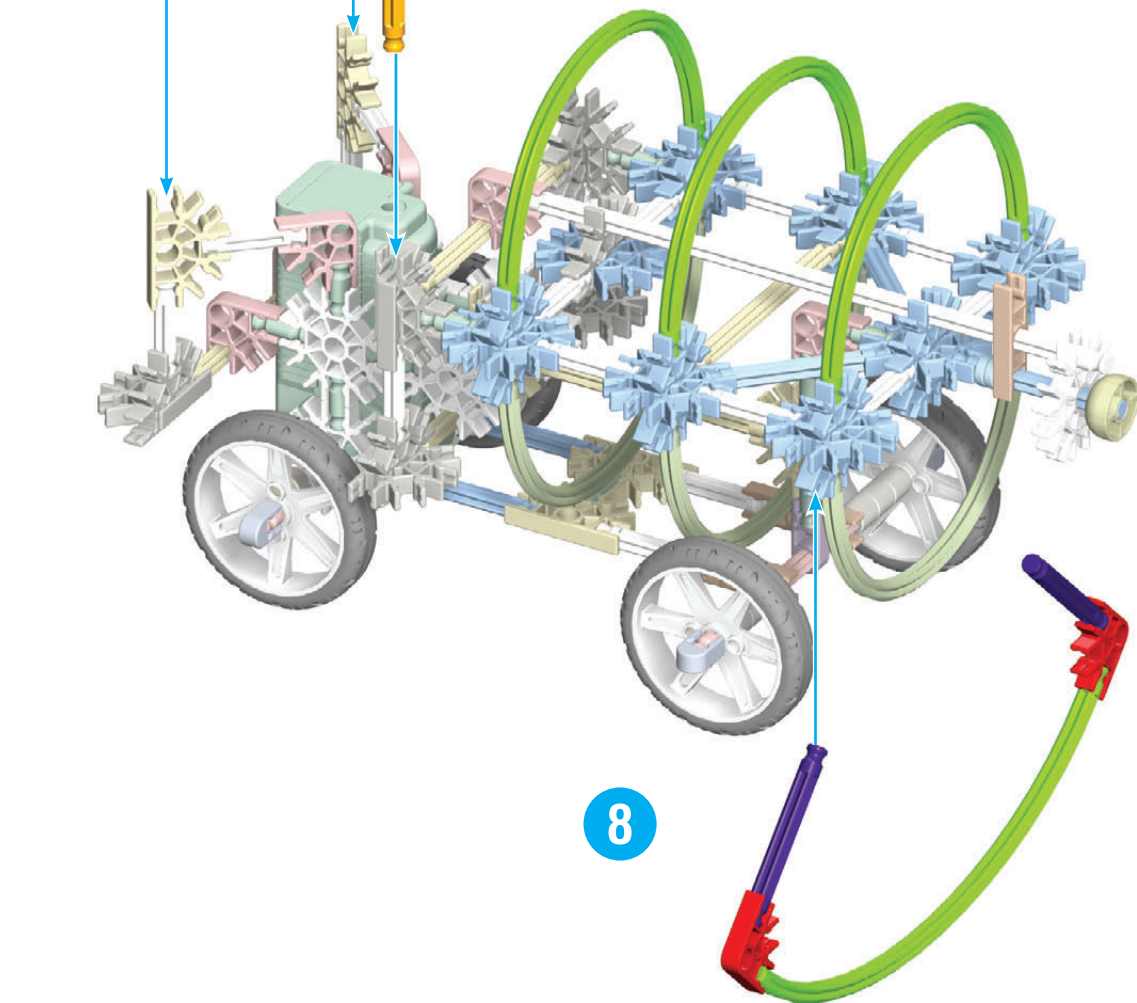

8

1 - 11

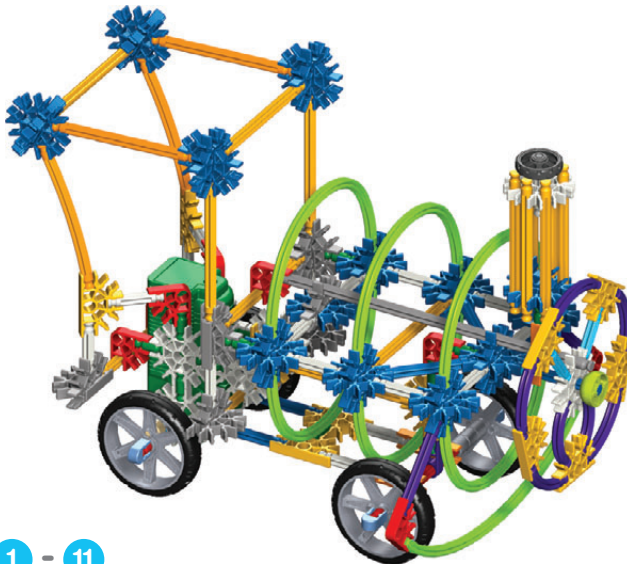

9

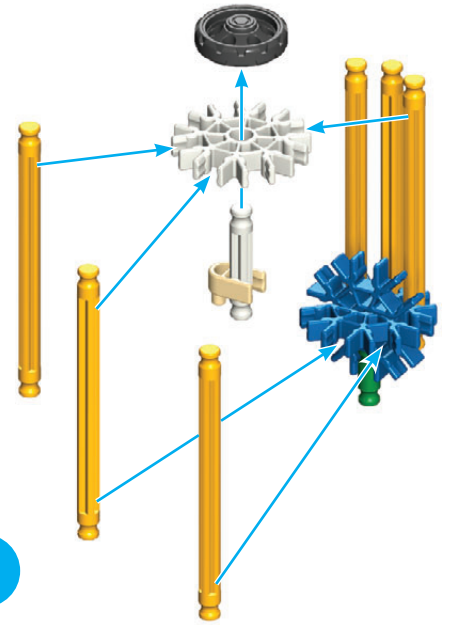

10

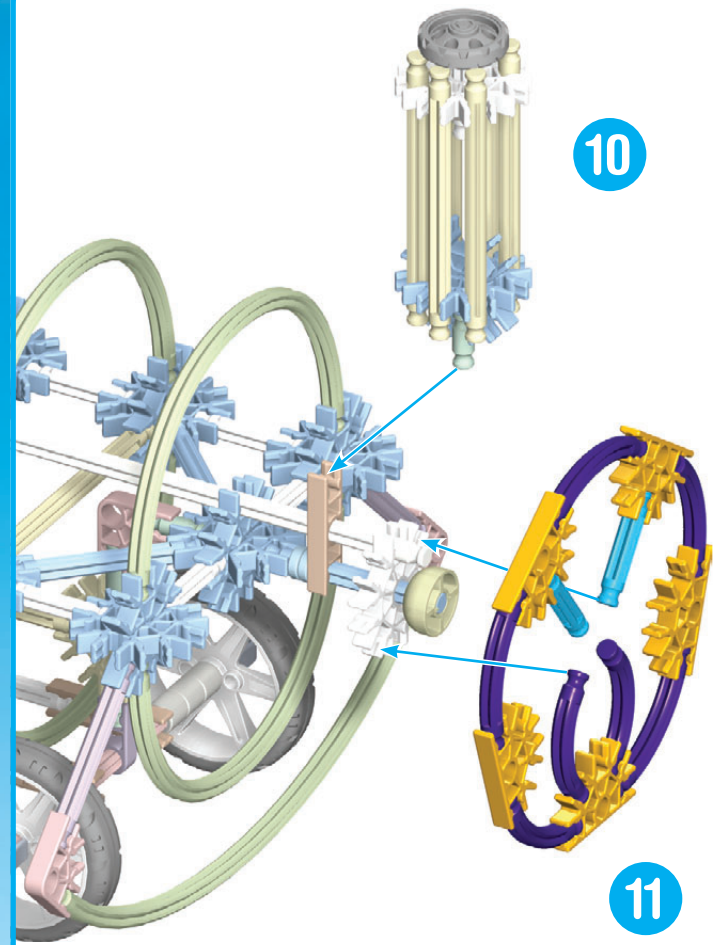

11

Play-Set Jeu-Ensemble

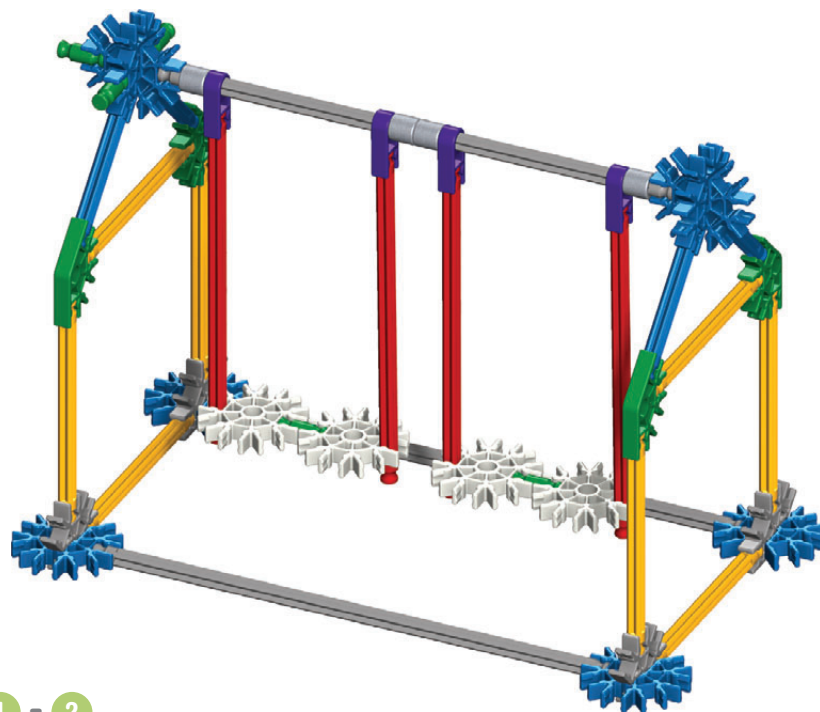
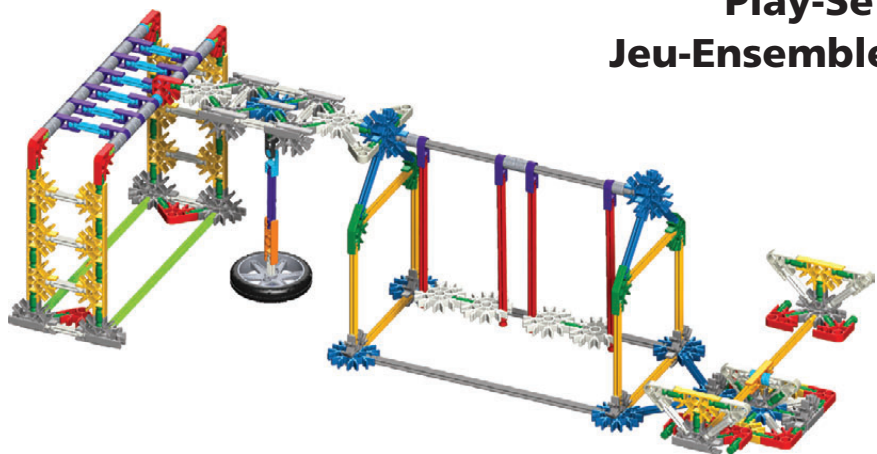

1 - 2

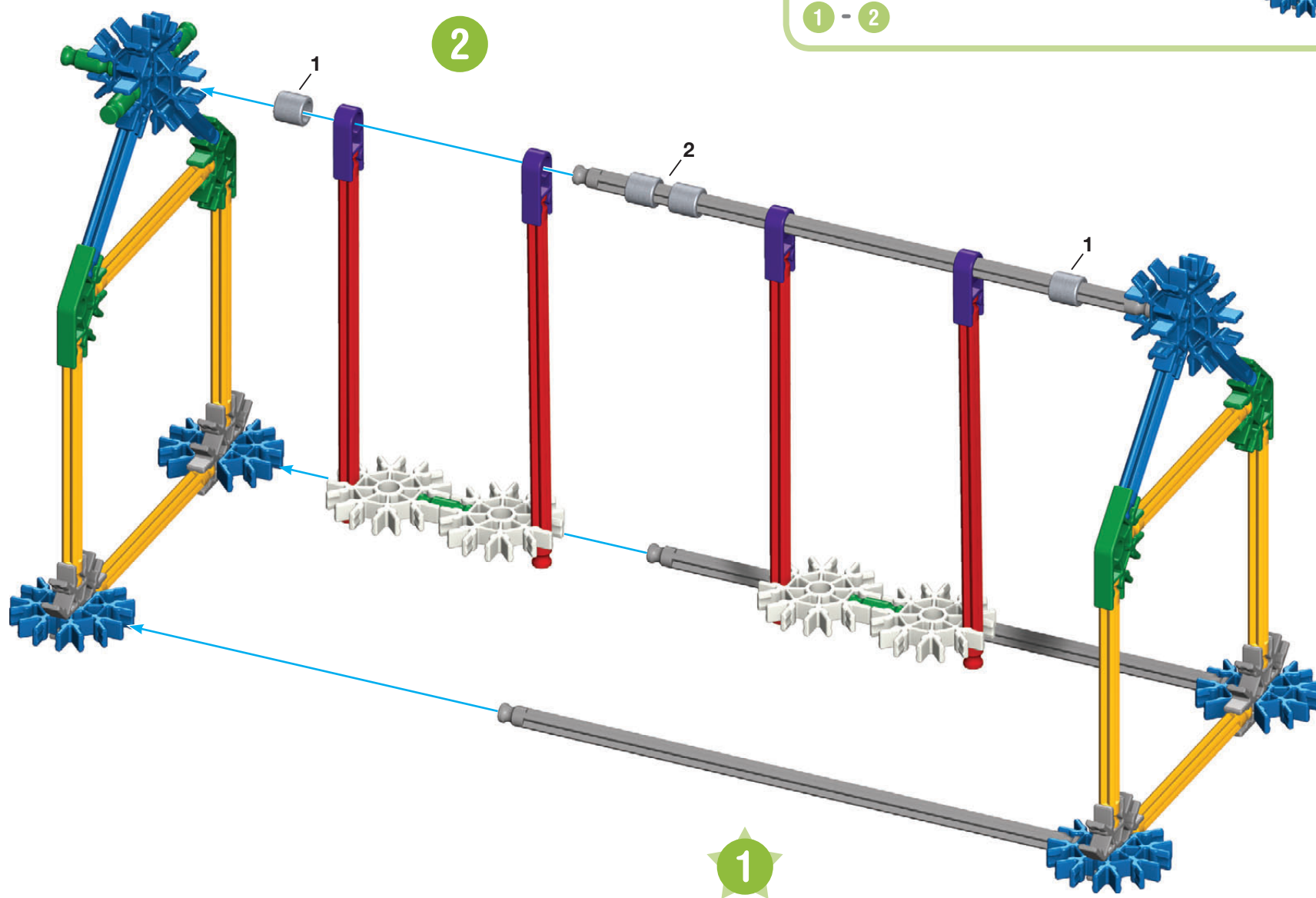

1

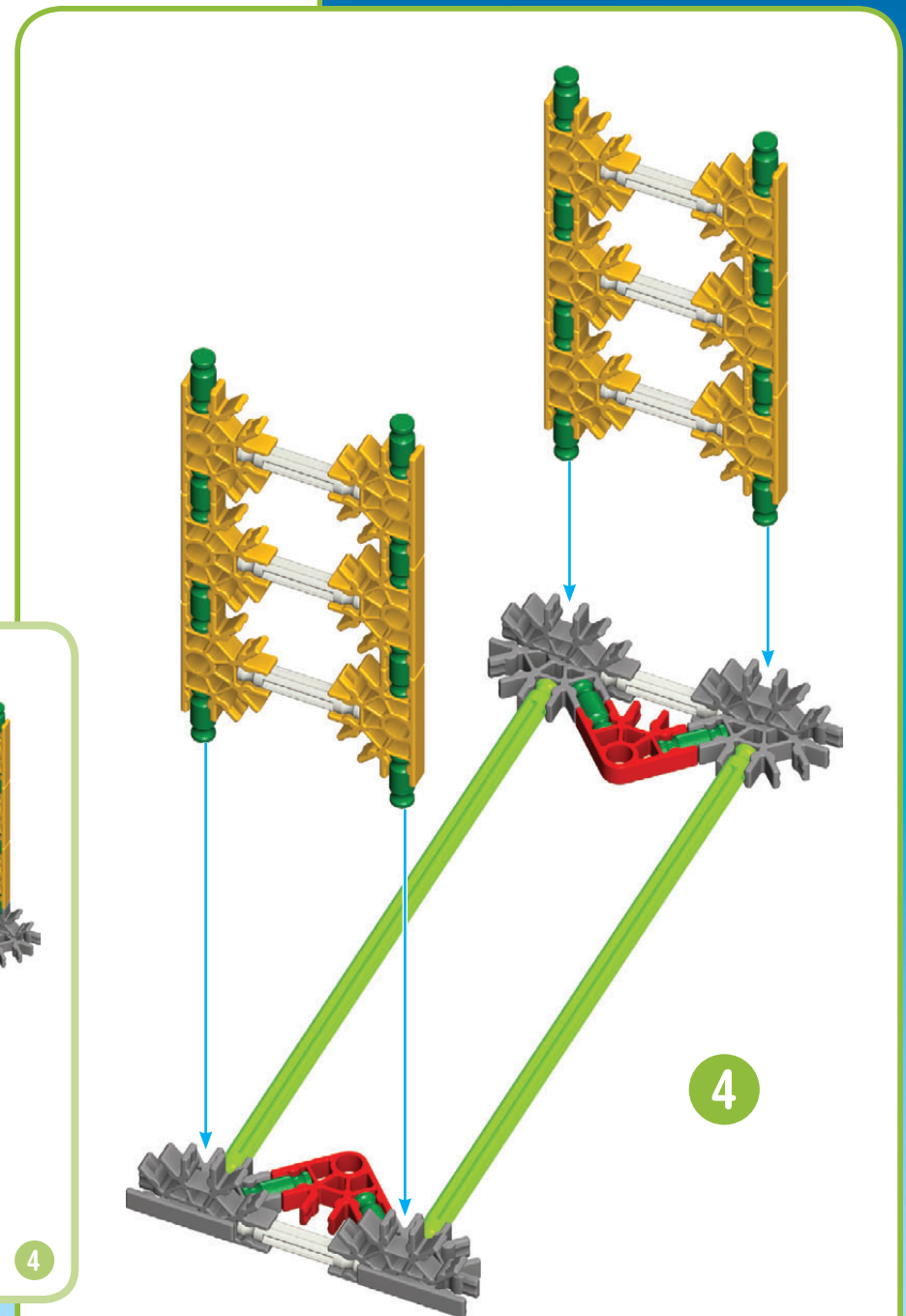
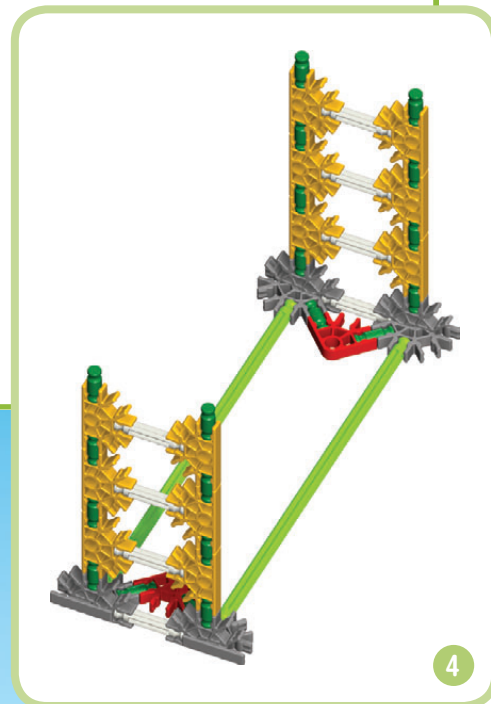
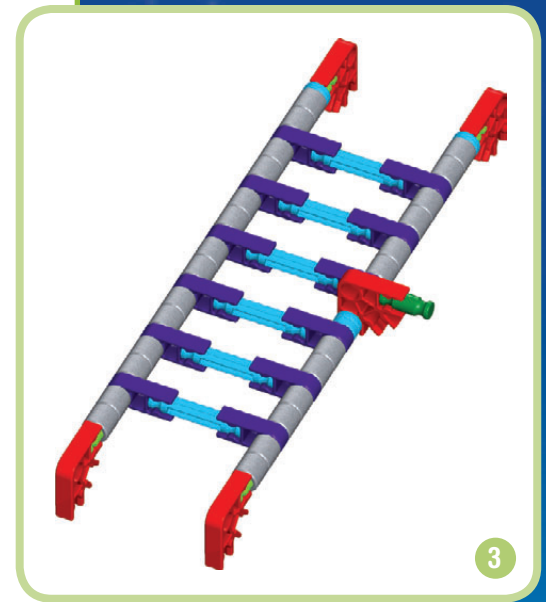
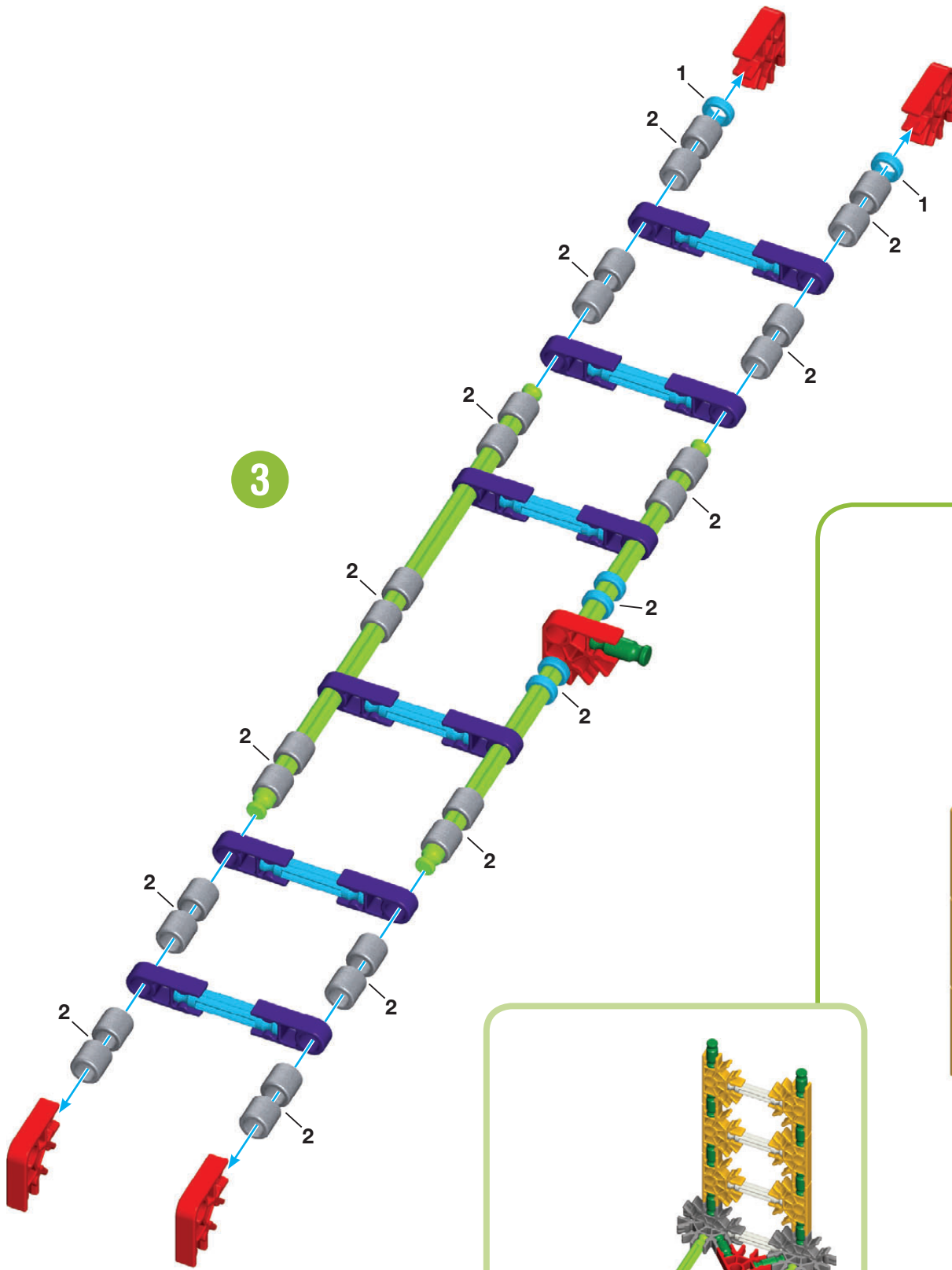

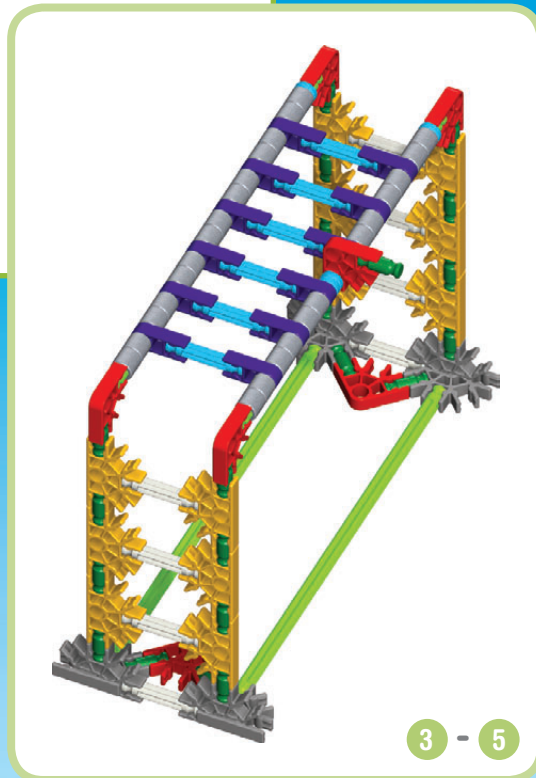
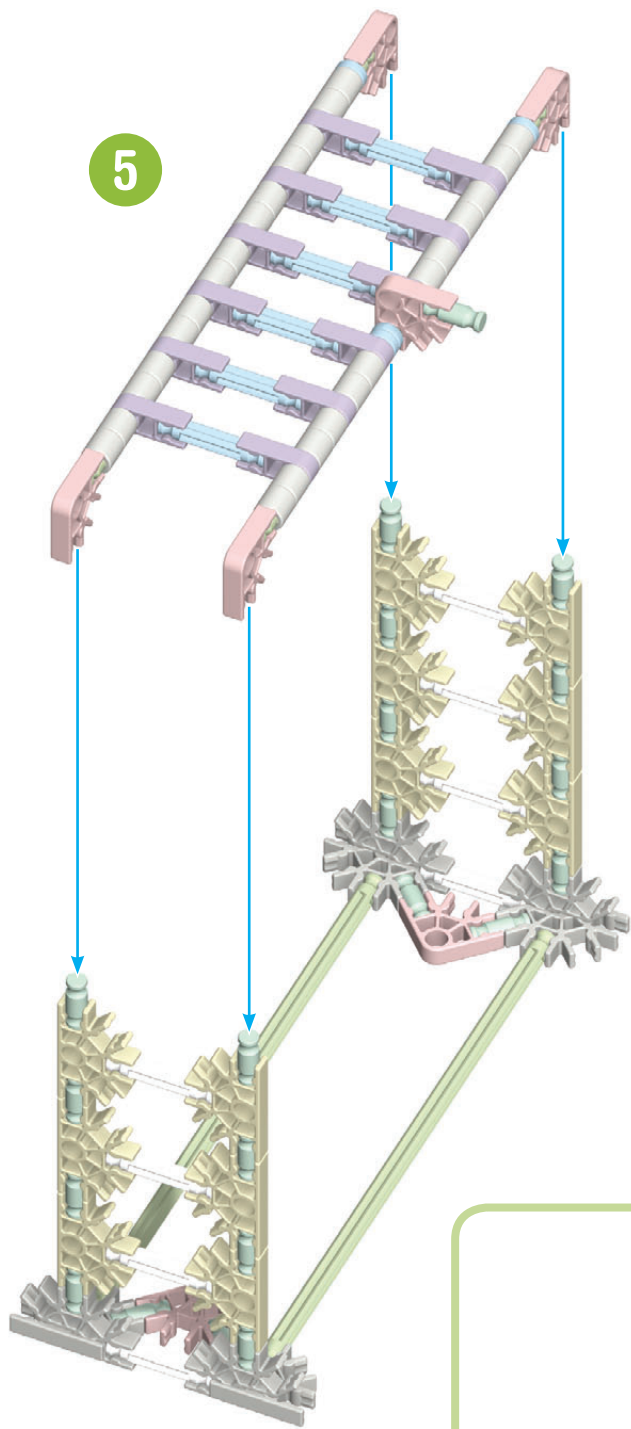

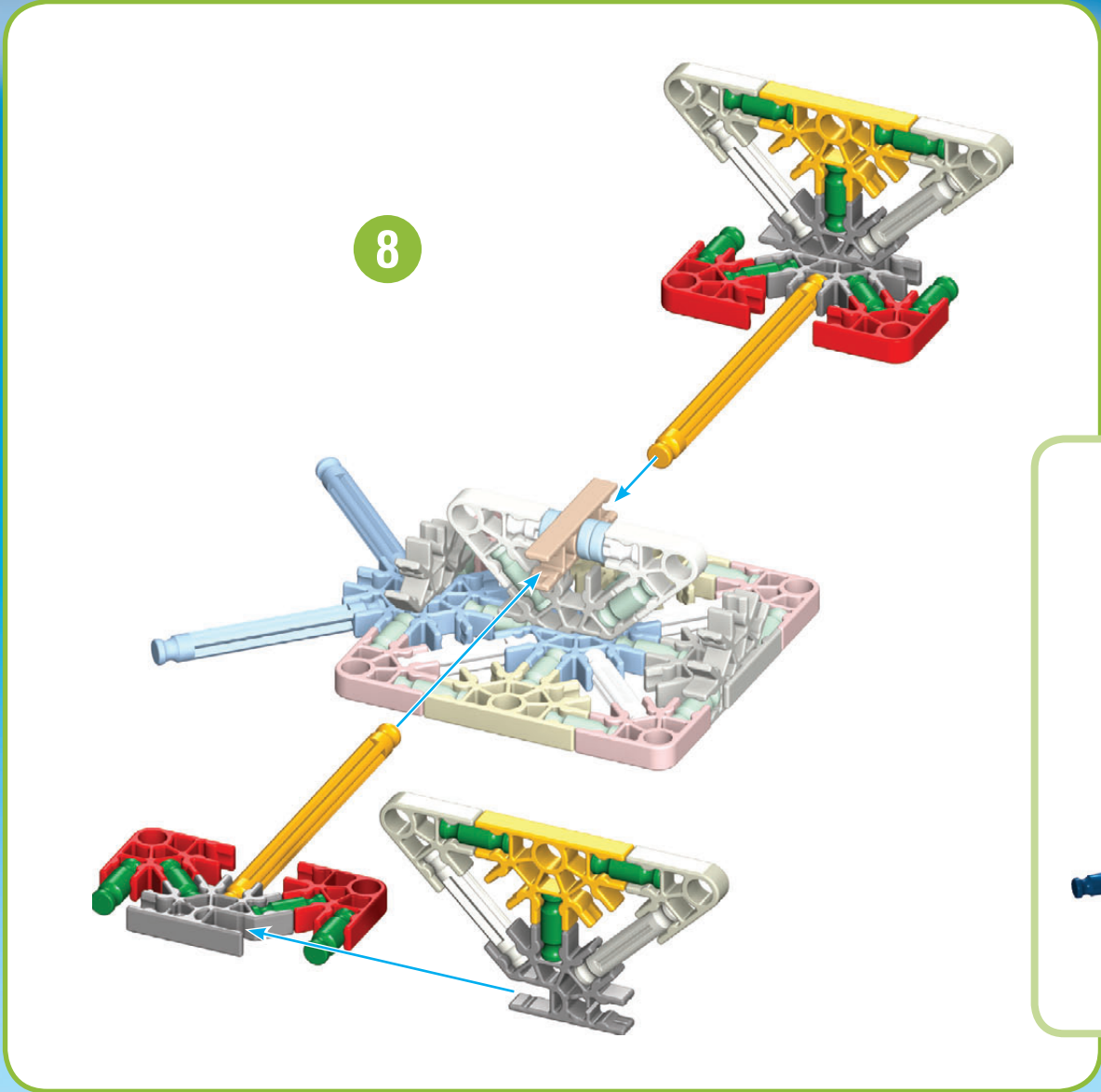
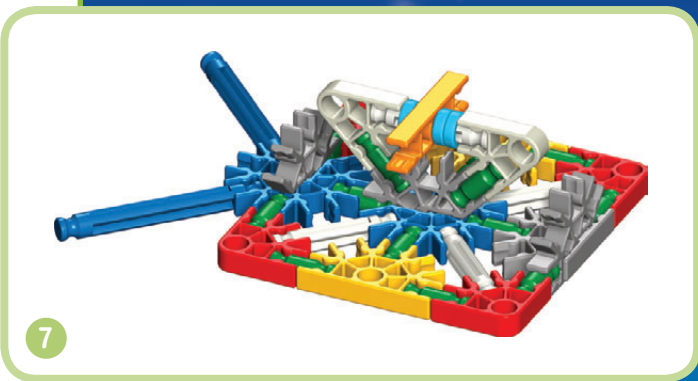
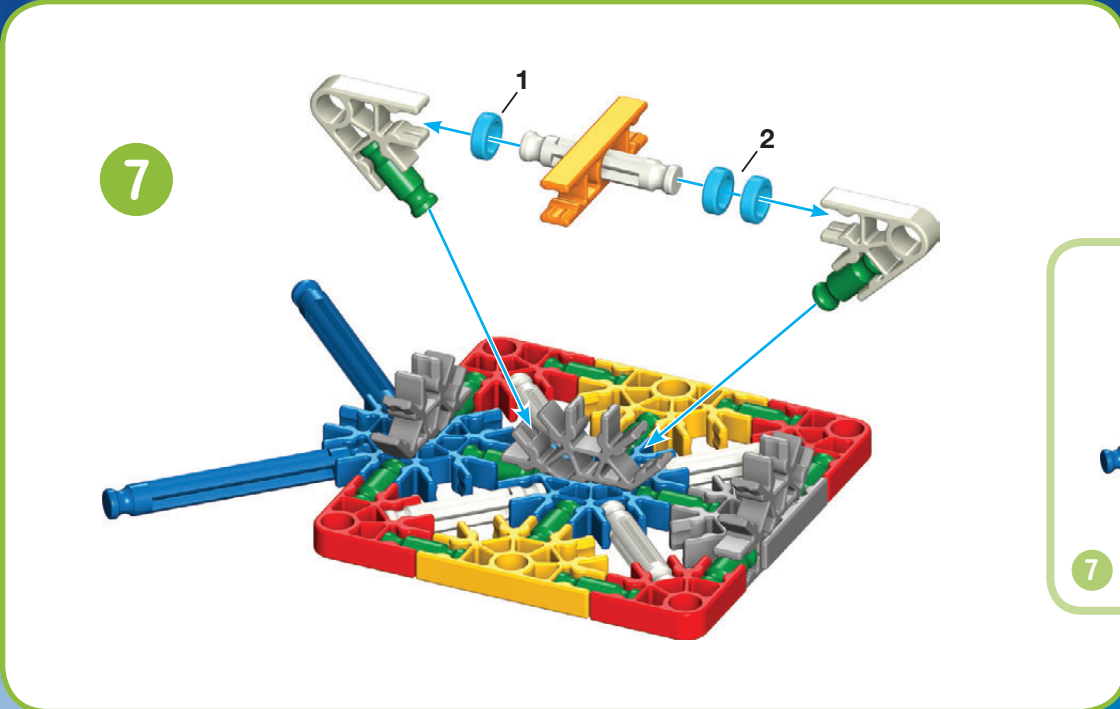



1 - 10



9

10

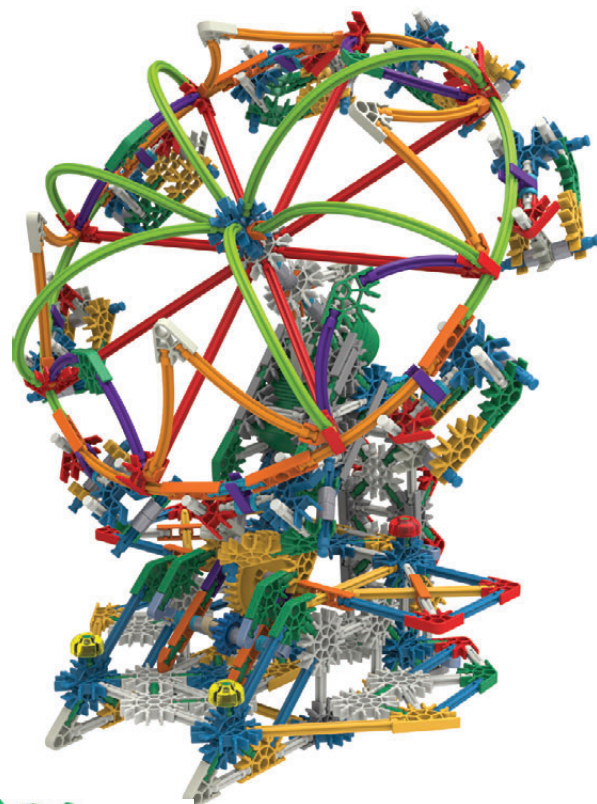
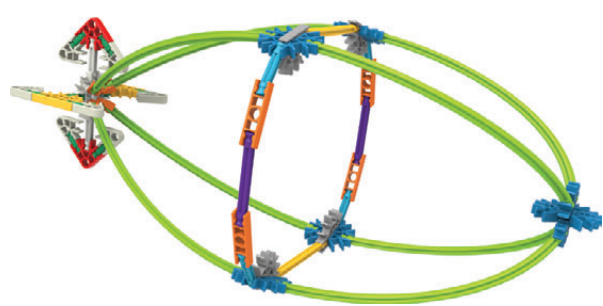

KNEX.COM

*For instructions of these models
go to www.knex.com/instructions
and enter code 12950.*

*Car les instructions de ces modèles
vont à www.knex.com/instructions
et entrez dans le code 12950.*

