

K'NEX®

Building Worlds Kids Love®

**55 MODEL
SUPER VALUE
BUILDING SET**

**55 MODÈLE
SUPER
VALEUR**

JEU DE CONSTRUCTION

**55 BUILDING
IDEAS!
IDÉES DE
CONSTRUCTION!***

7+

16482



**With Classic &
Micro K'NEX Parts!**



**Avec les pièces classique
et micro de K'NEX!‡**

* ¡Ideas de construcción!
Bauvorschläge!
Idee di costruzione!
Idéias de construção!
Bouwideoën!

‡ ¡Con Partes Clásicos y Micro de K'NEX!
Mit klassischen & Mikro K'NEX Teilen!
Con pezzi classici e micro K'NEX!
Com Peças Clássicas e micro K'NEX!
Met Klassieke & micro K'NEX Onderdelen!

CONTENTS

Moose/Snowboarder4	Eggbeater10
Tow Truck/Squirrel.....5	Jet.....12
Butterfly/Weightlifter.....6	Dragster14
Submarine7	Dune Buggy.....17
Hammerhead Shark.....8	Dump Truck.....20
Swing Ride9	Building Ideas23

Parts List

Before you start building, be sure to compare the parts in your set with the parts list here. If anything is missing, call or write to us using the information on the back cover. We are here to help you!



K'NEX Building Basics

Start Building

To begin your model, find the **1** and follow the numbers. Each piece has its own shape and color. Just look at the pictures, find the pieces in your set that match and then connect them together. Try to face your model in the same direction as the instructions while you build. The arrows show you where the parts connect, but not all connections points have arrows. Faded colors show you this section is already built.

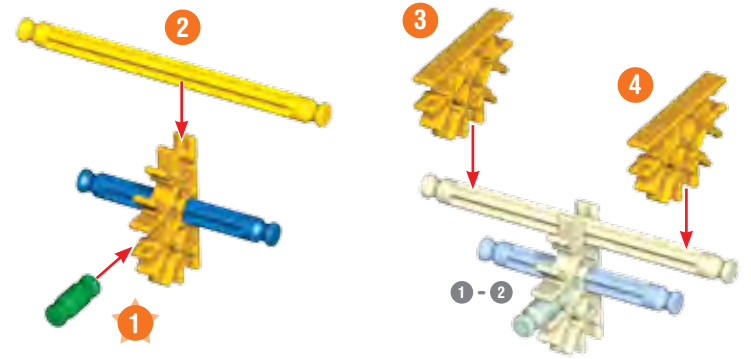

Spacers

There are places in your model where you need to add spacers. Be sure to use the correct number of spacers shown in the instructions.



Connectors

You can slide these special connectors together. Push tightly until you hear a "click". Pay close attention to the instructions and position them horizontally or vertically exactly as they are shown.

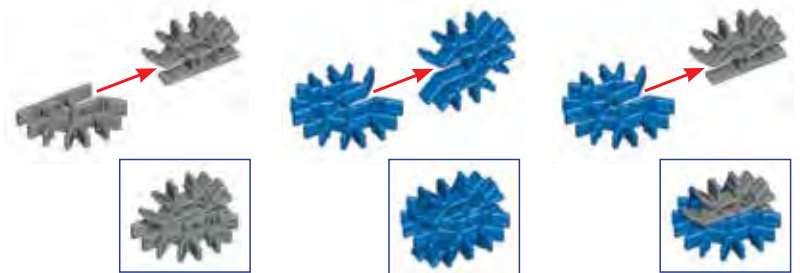

Élan/Snowboarder4	Fouet à oeufs..... 10
Dépanneuse/Écureuil5	Jet..... 12
Papillon/Haltérophile6	Dragster 14
Sous-marin7	Dune Buggy..... 17
Requin Marteau8	Camion-vidage20
Se Balancer Monter9	Idée de Construction23

Liste des pièces

Avant de commencer à construire, assure-toi de comparer les pièces dans ta boîte à la liste de pièces fournie ici. S'il manque quelque chose, téléphone-nous ou écris-nous en te servant des informations figurant au verso de la notice. Nous sommes là pour t'aider !



Démarrer la construction

Pour commencer le modèle, cherche l'étape numéro 1 et suis les numéros dans l'ordre. Chaque pièce a sa propre forme et sa propre couleur. Regarde les illustrations, trouve les pièces qui y correspondent et les assemble-les. Pour te faciliter la tâche, oriente le modèle dans le même sens que les instructions. Les flèches indiquent où les pièces s'assemblent, mais les points de raccordement n'ont pas tous des flèches. Les pièces ayant une couleur estompée sont celles déjà assemblées.

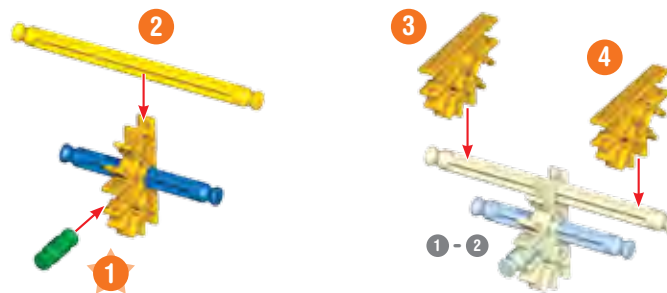

Séparateurs

Il y a des endroits sur le modèle où des séparateurs sont nécessaires. Assure-toi d'utiliser la bonne nombre de séparateurs, comme indiqué sur les instructions.



Connecteurs

Tu peux assembler ces connecteurs spéciaux en les faisant glisser l'un dans l'autre. Pousse fort jusqu'à entendre un « clic ». Lis attentivement les instructions et positionne-les horizontalement ou verticalement, en suivant exactement les illustrations.

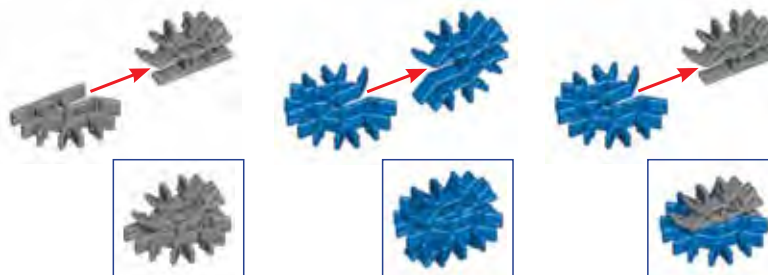

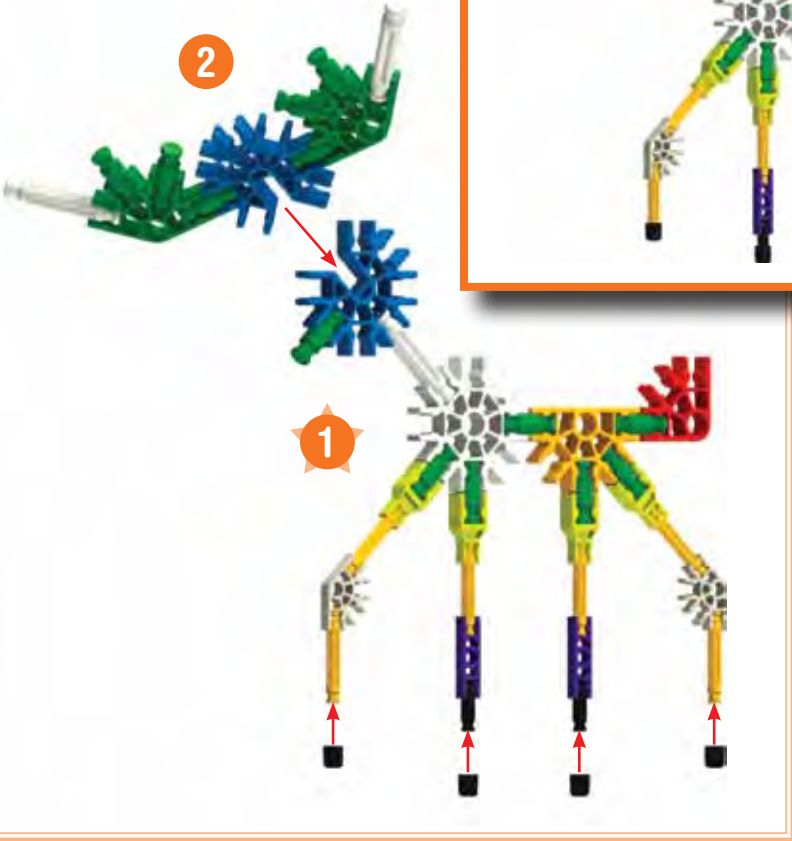

! **WARNING:** CHOKING HAZARD – Small parts. Not for children under 3 years.
ATTENTION : RISQUE D'ÉTOUFFEMENT – Pièces de petite taille. Ne convient pas aux enfants de moins de 3 ans.
ADVERTENCIA: PELIGRO DE ASFIXIA – Piezas pequeñas. No para niños menores de 3 años.
ACHTUNG: ERSTICKUNGSGEFAHR – Kleinteile. Nicht geeignet für Kinder unter 3 Jahren.
AVVISO: PERICOLO DI SOFFOCARE – Pezzi piccoli. Non adatto per bambini sotto 3 anni.
AVISO: PERIGO DE SUFOCAÇÃO – Peças pequenas. Não se destina a crianças com menos de 3 anos de idade.
WAARSCHUWING: INSLIKKINGSGEVAAR – Kleine onderdelen. Niet geschikt voor kinderen jonger dan 3 jaar.

CAUTION: Keep hands, face, hair and clothing away from all moving parts.
ATTENTION : Garde les cheveux, les doigts, la visage et les vêtements à l'écart de toutes les pièces mobiles.
PRECAUCIÓN: Mantén el cabello, los dedos, la cara y la ropa alejada de las piezas móviles.
VORSICHT: Haare, Finger, Gesicht und Kleidungsstücke nicht mit beweglichen Teilen in Berührung kommen lassen.
ATTENZIONE: Tenere i capelli, le dita, il viso e i vestiti lontano da tutte le parti in movimento.
CUIDADO: Mantém o cabelo, os dedos, a cara e a roupa afastados de todas as peças móveis.
LET OP: Hou het haar, de vingers, het gezicht en kledij verwijderd van alle bewegende onderdelen.

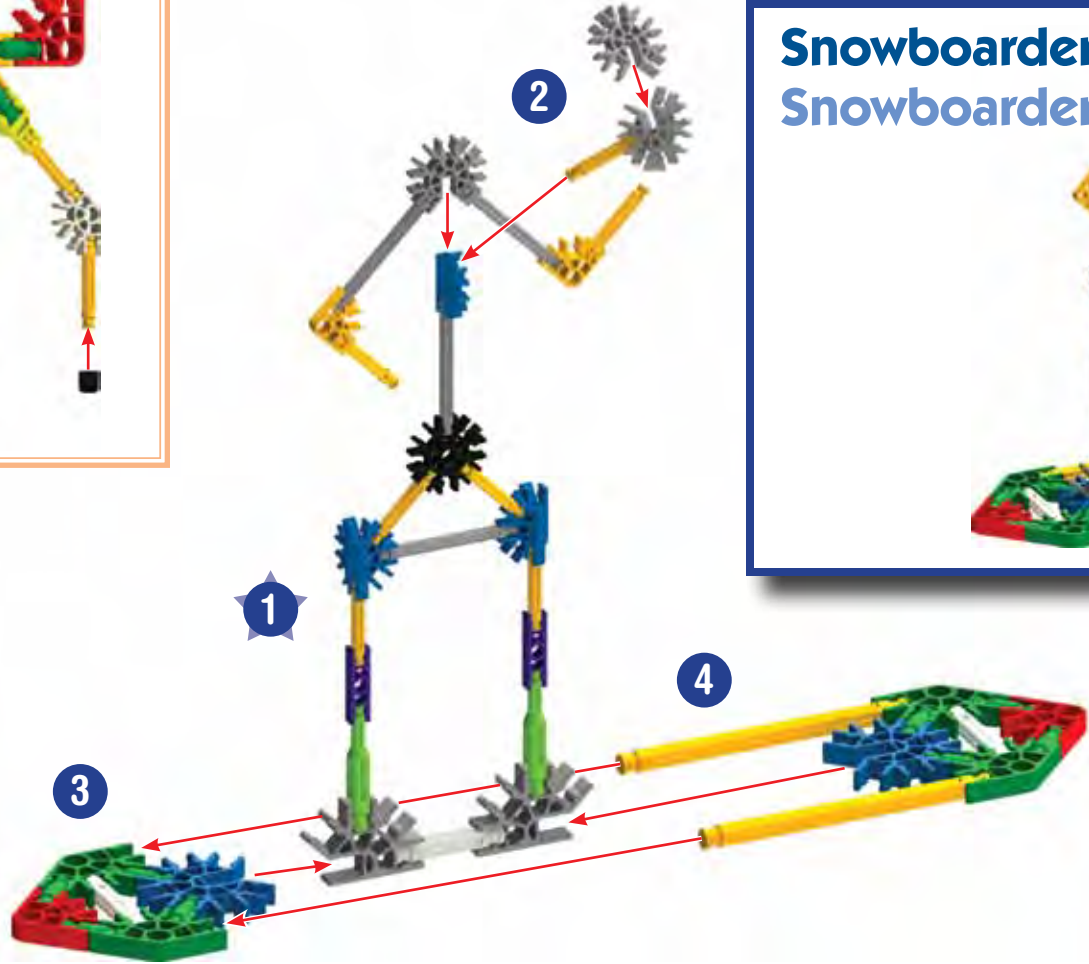

Tow Truck Dépanneuse

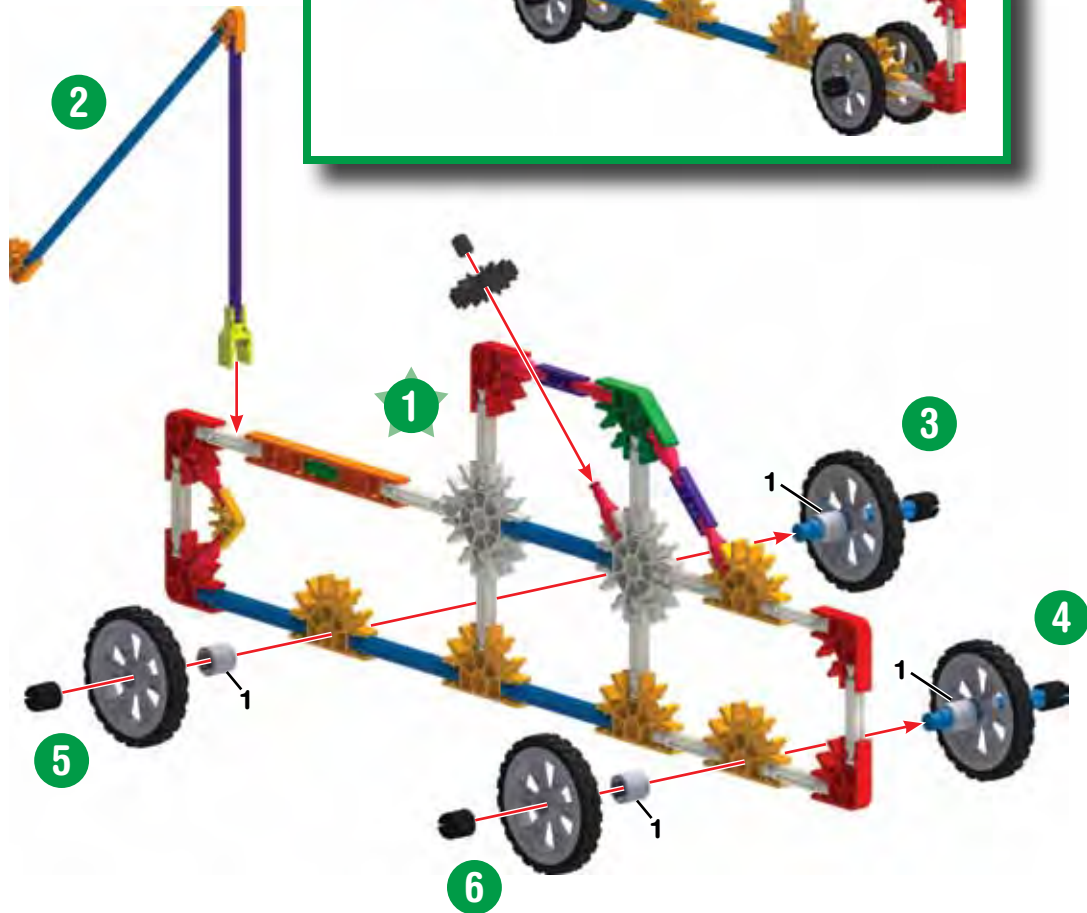
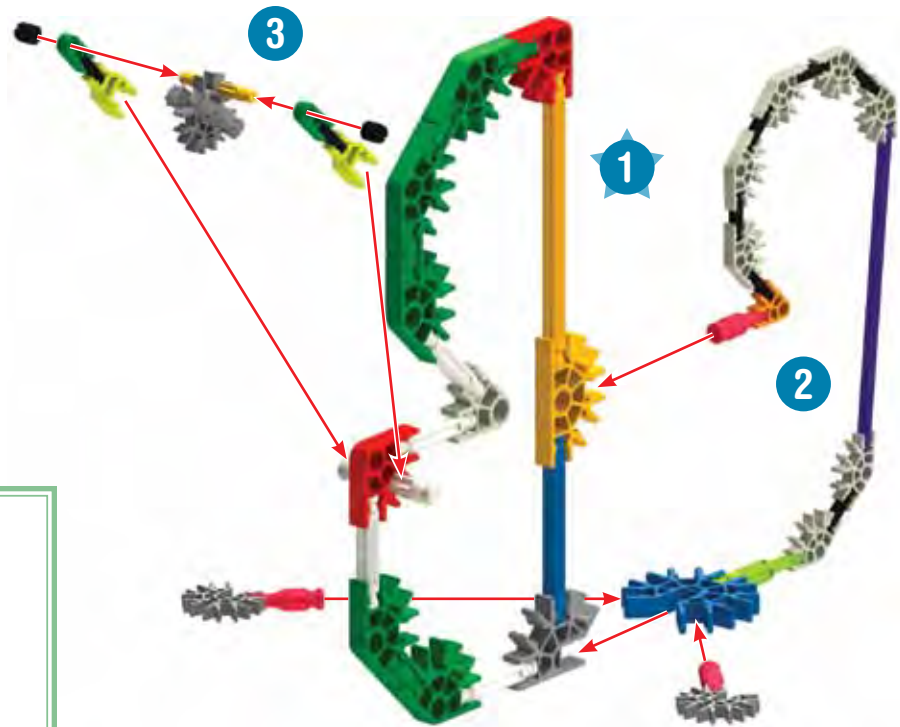

Squirrel Ecureuil



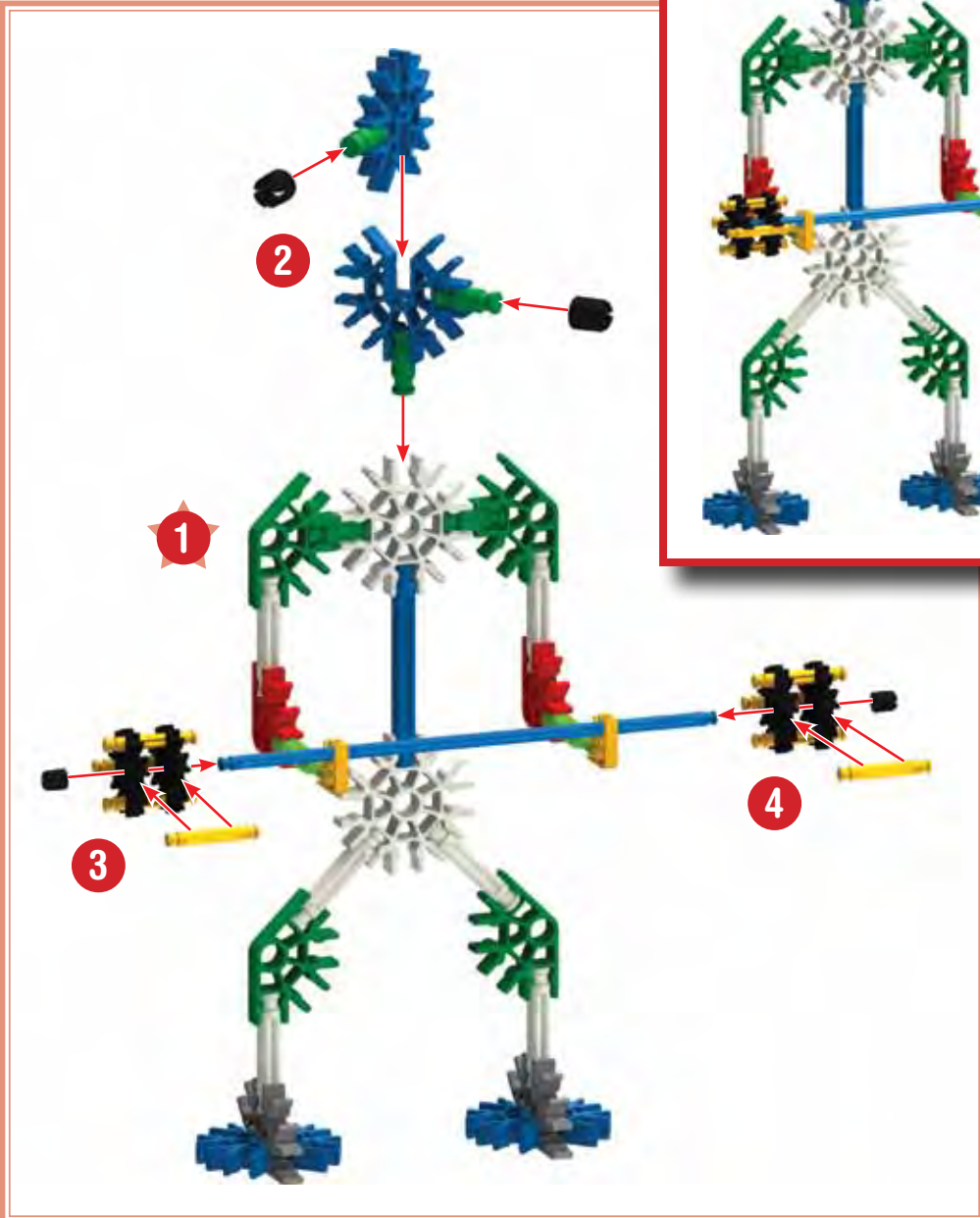
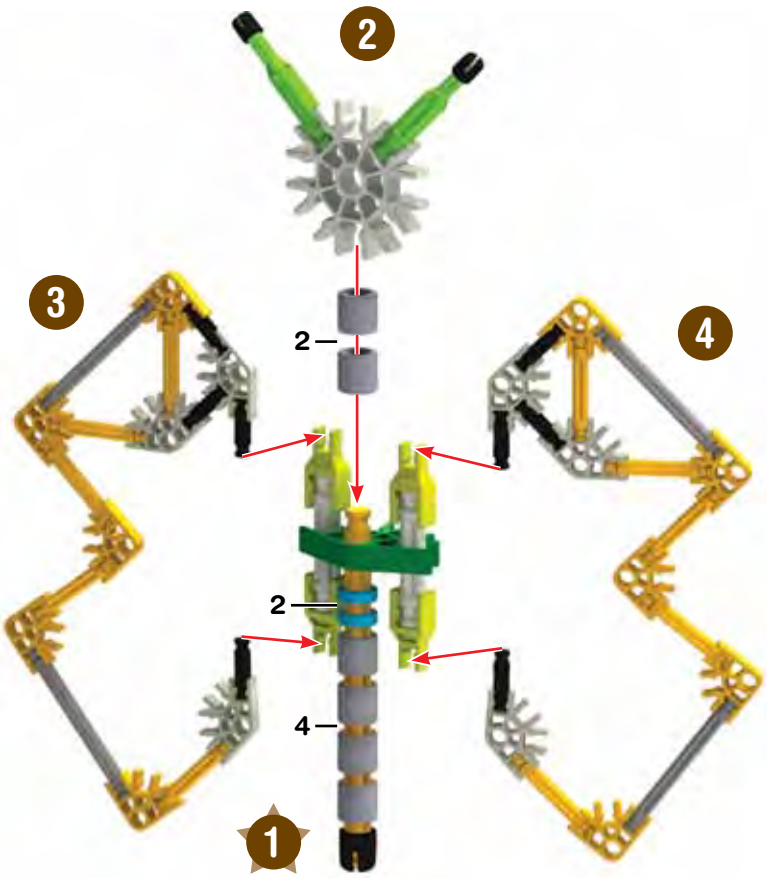
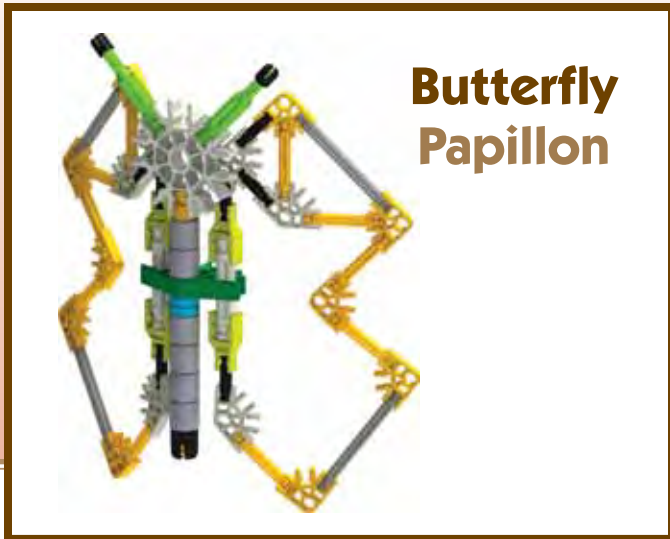

Submarine Sous-marin

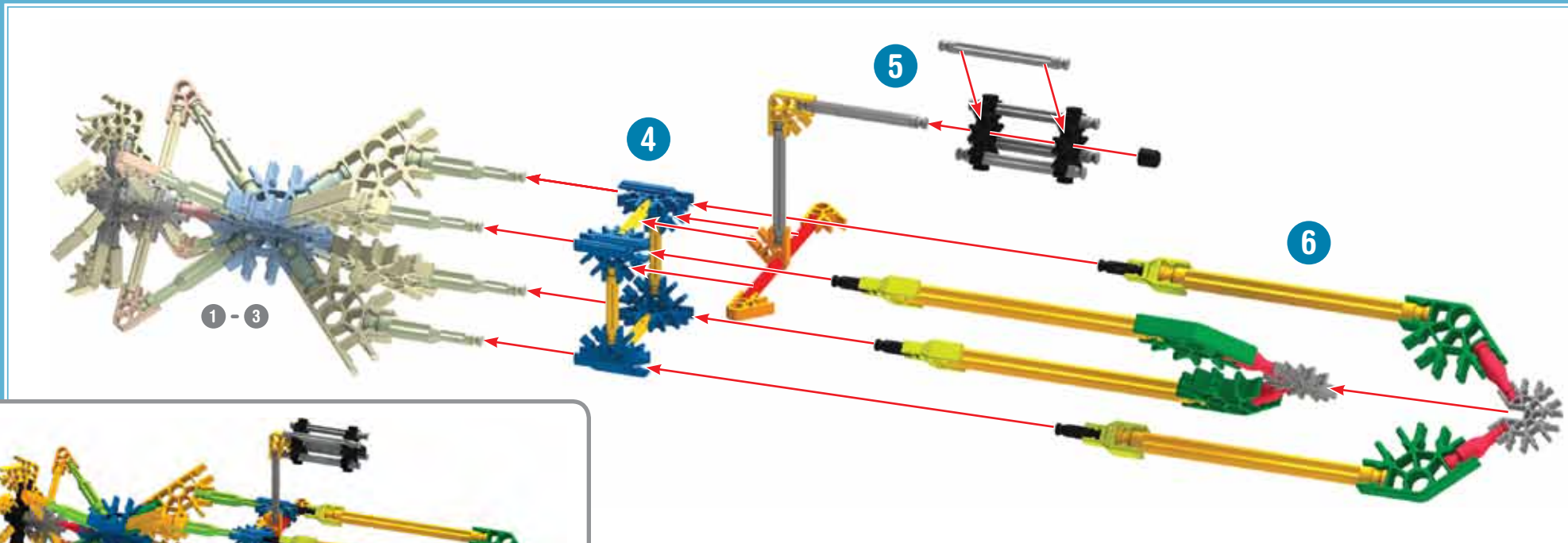
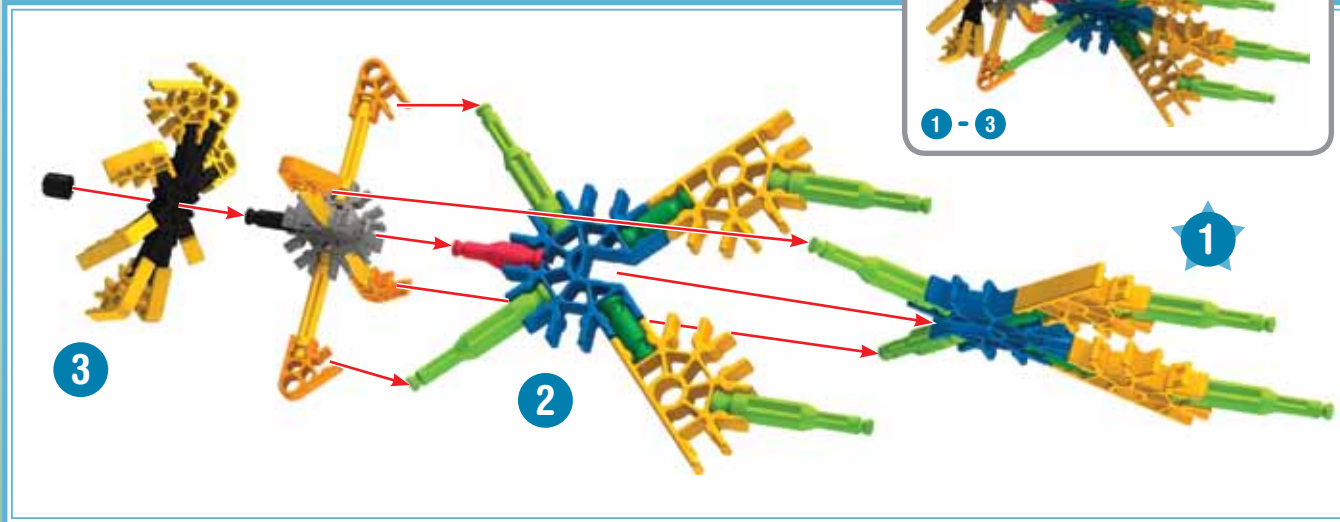

Hammerhead Shark Requin Marteau

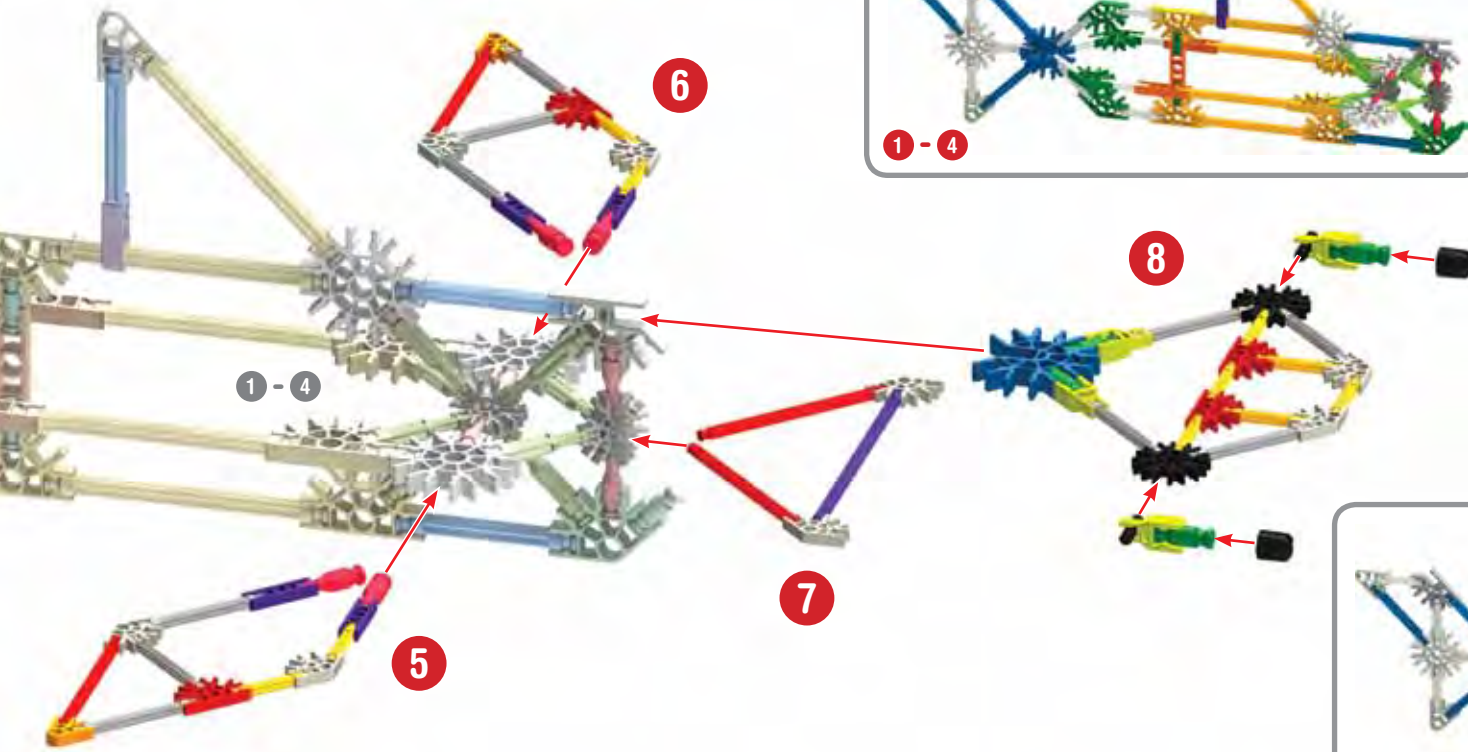
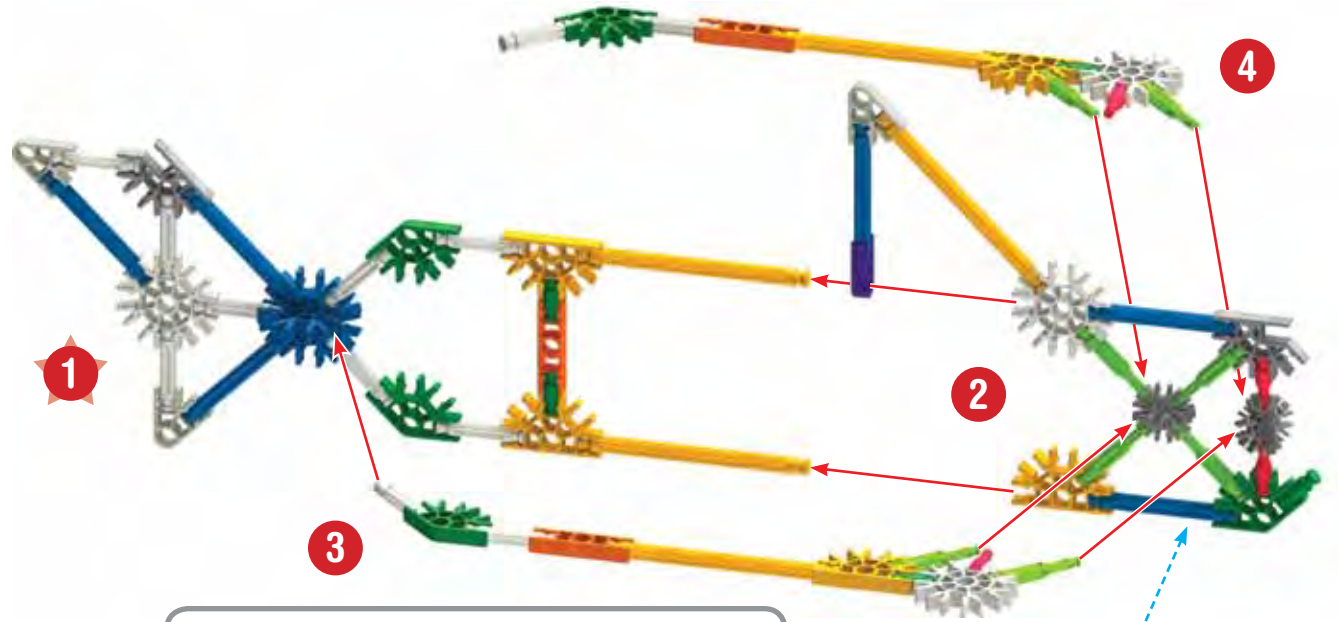

Swing Ride Se Balancer Monter

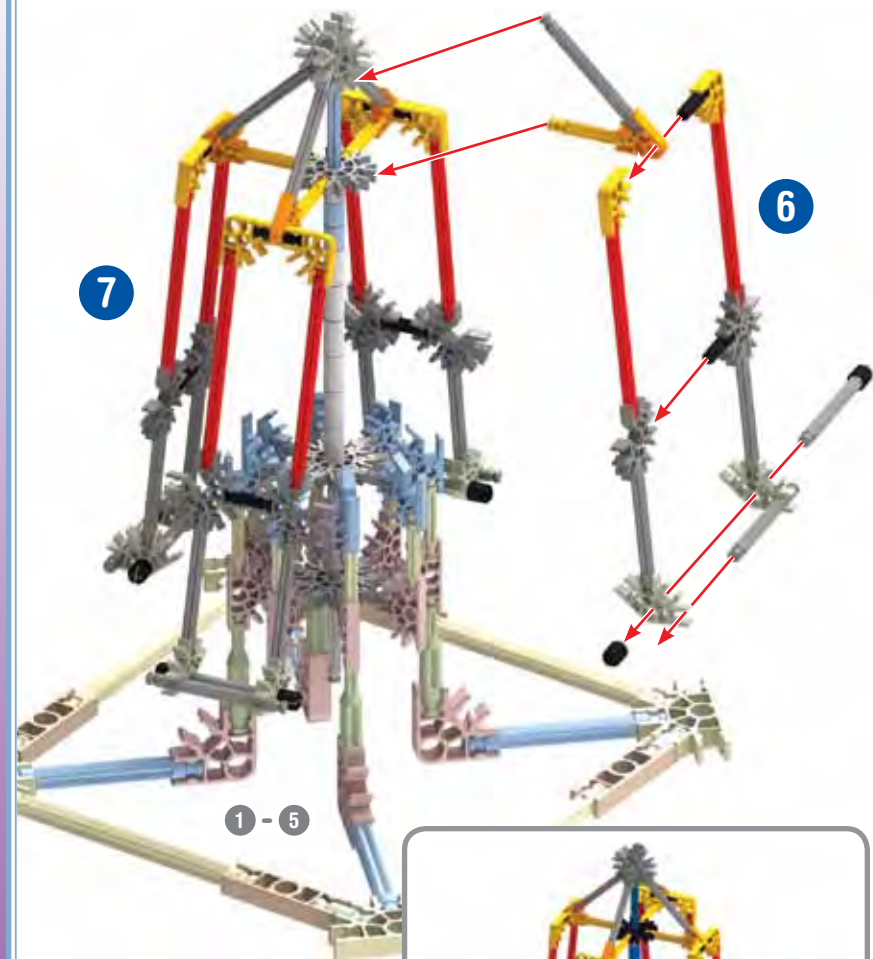
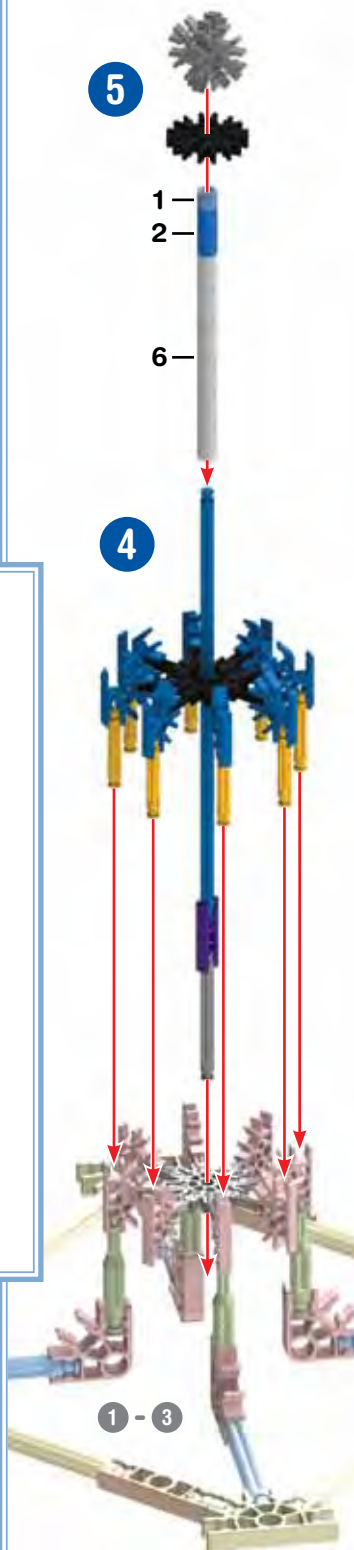
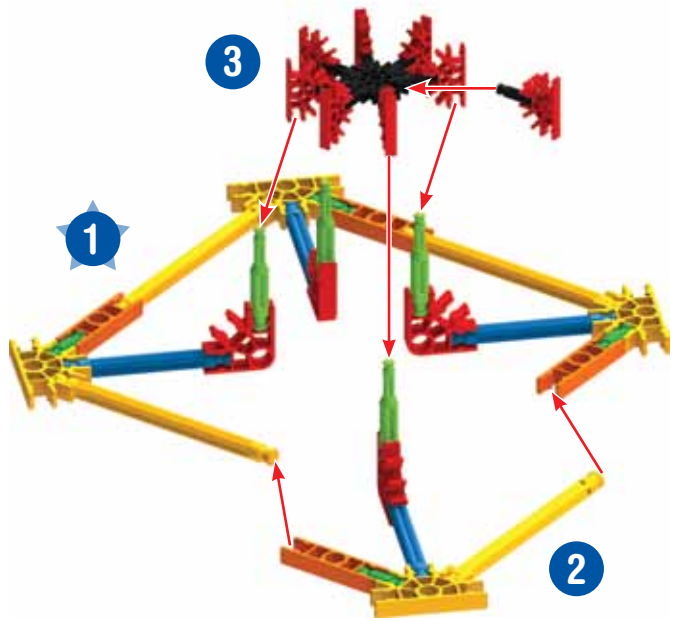

Eggbeater

Fouet à oeufs

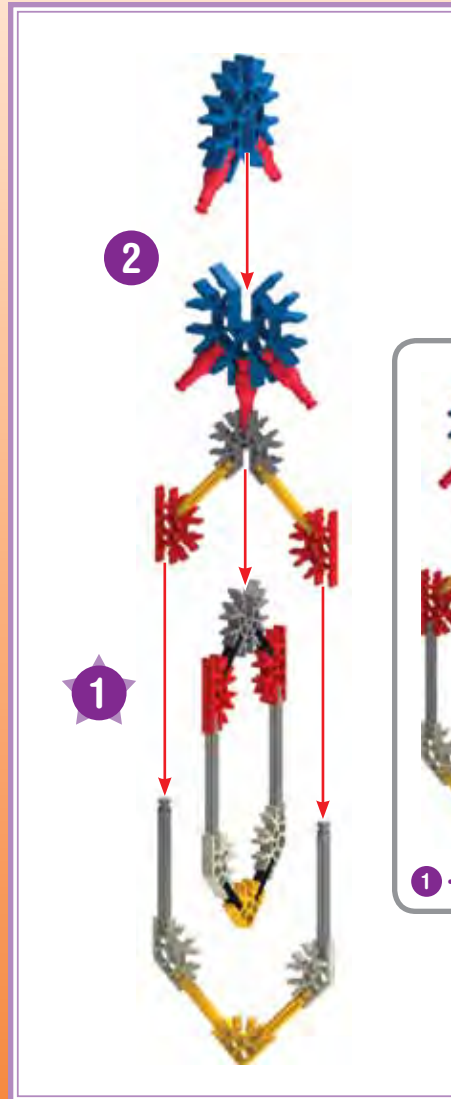

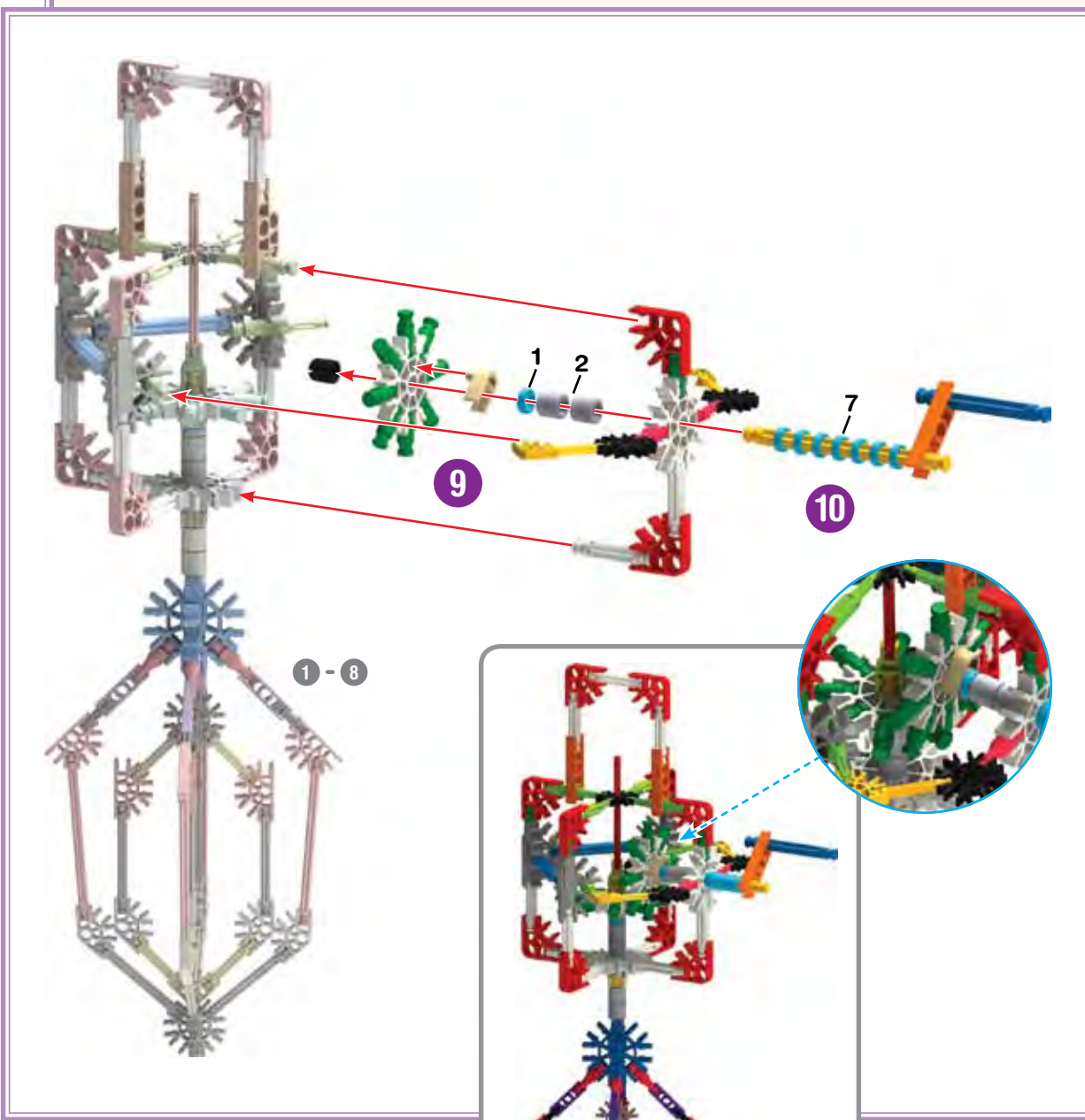
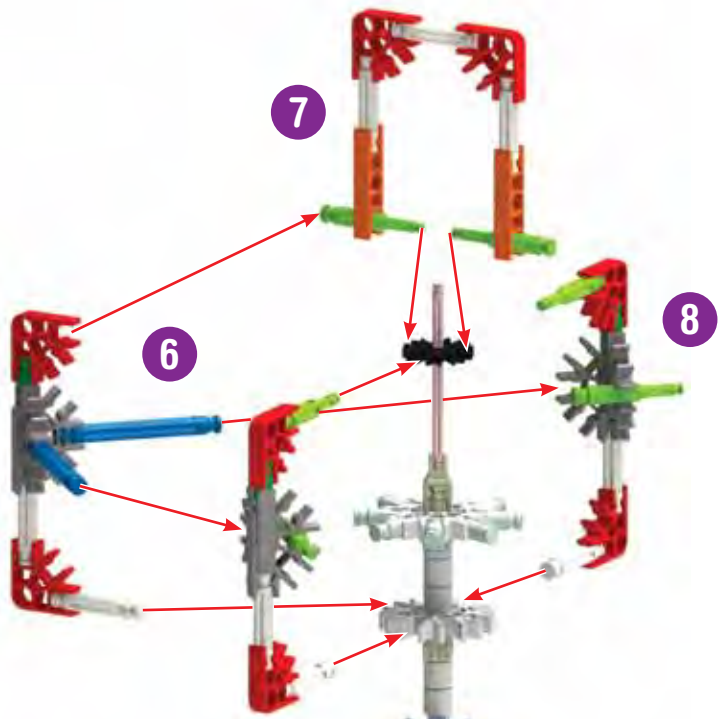

Jet Jet

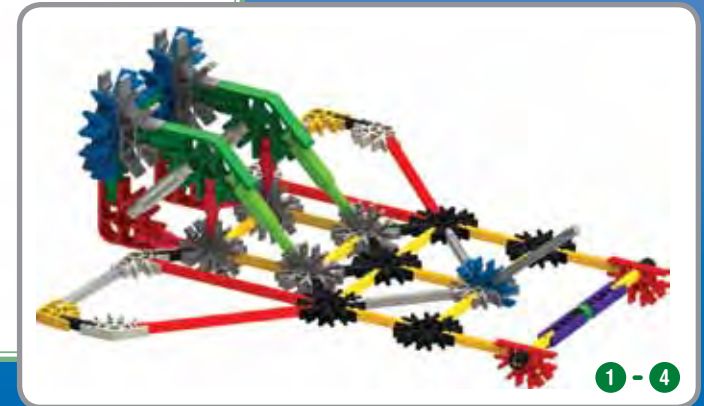
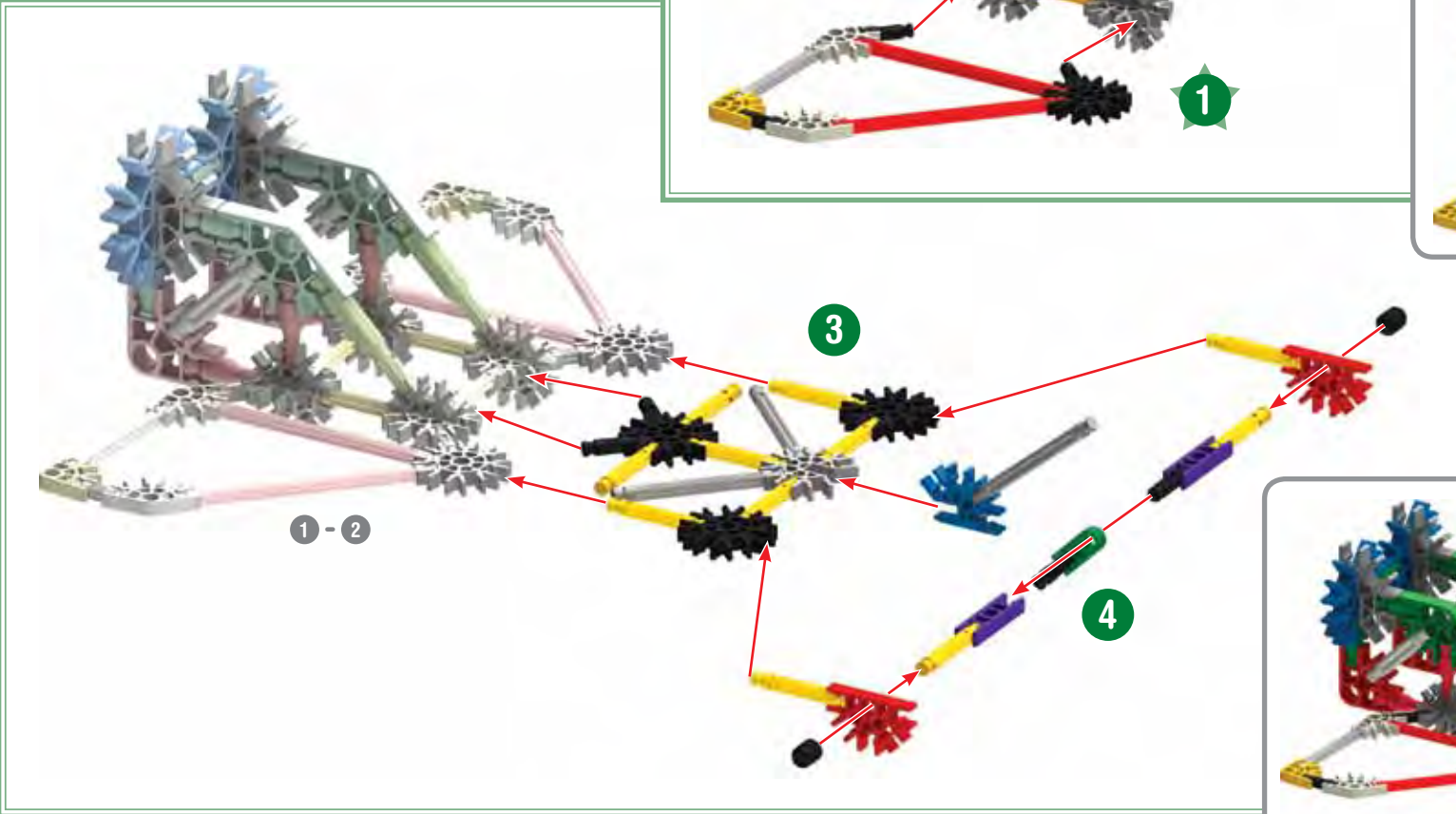
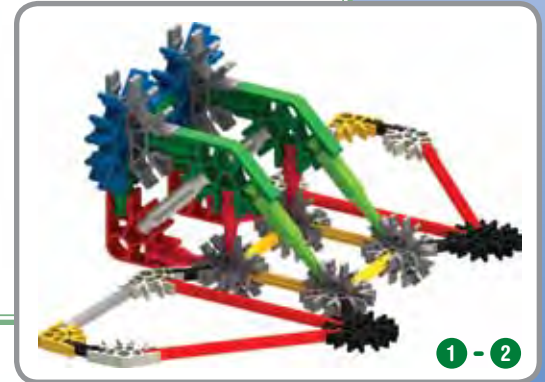
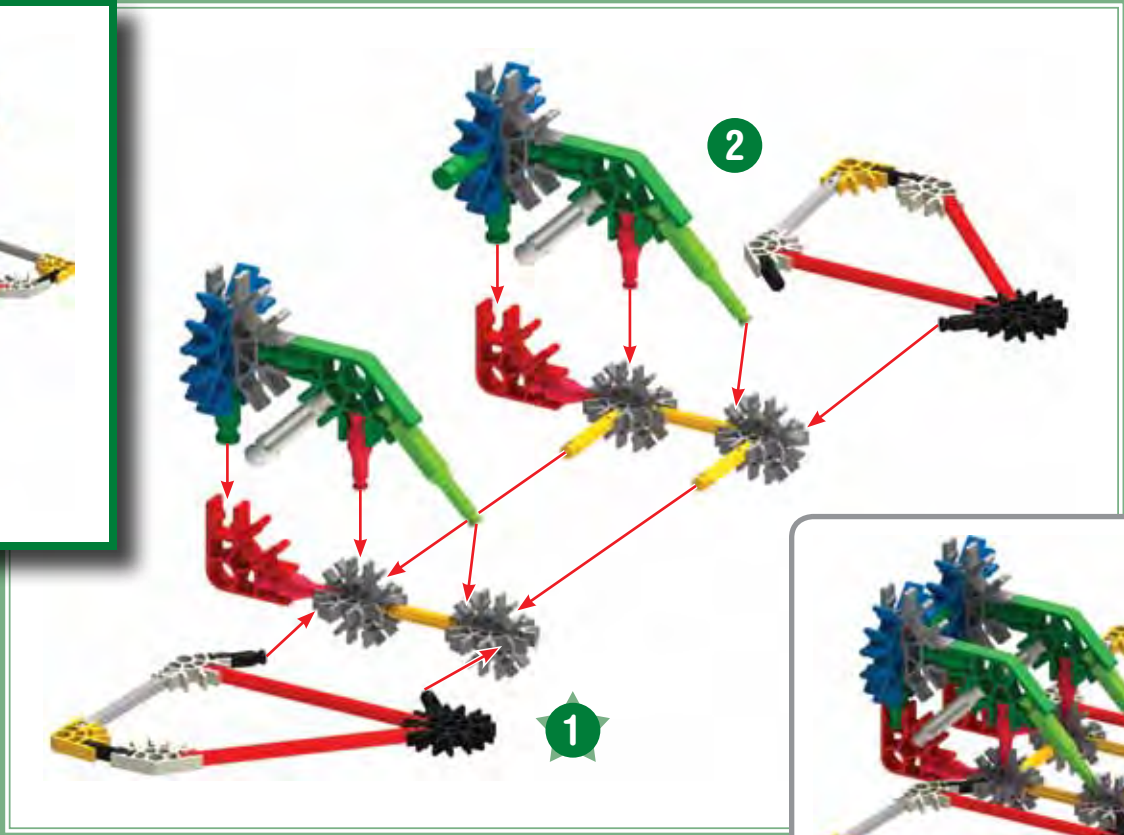

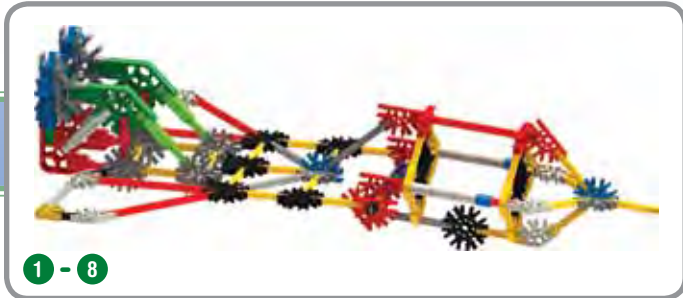
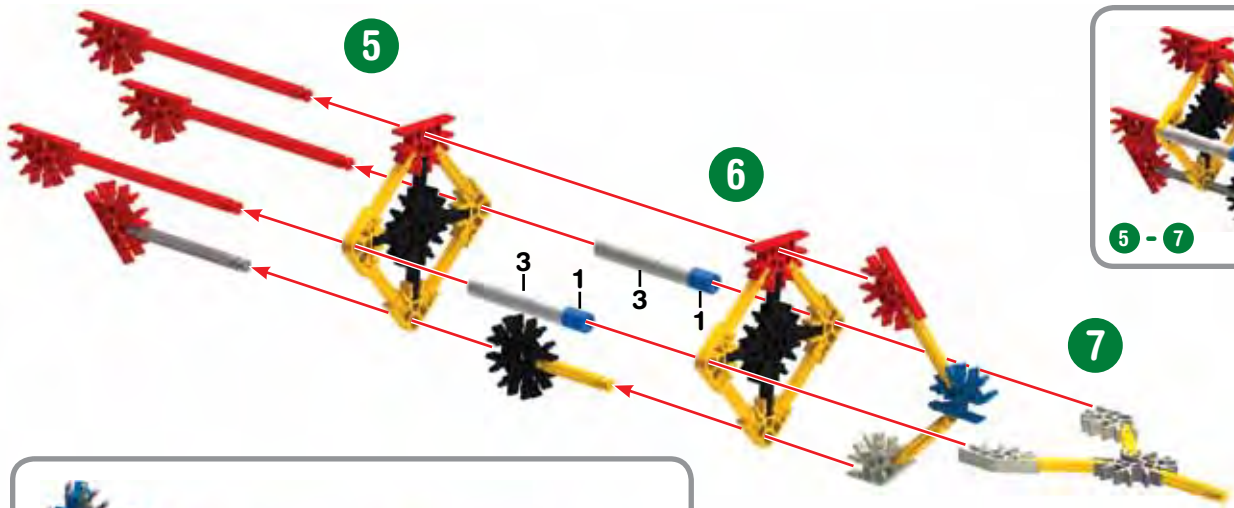

rotate model
pivoter le modèle

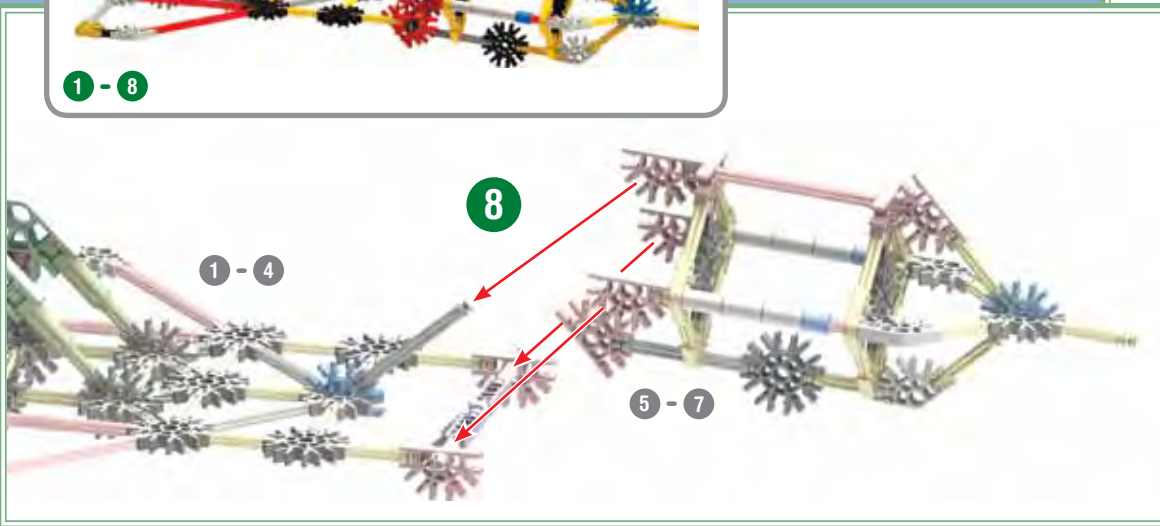
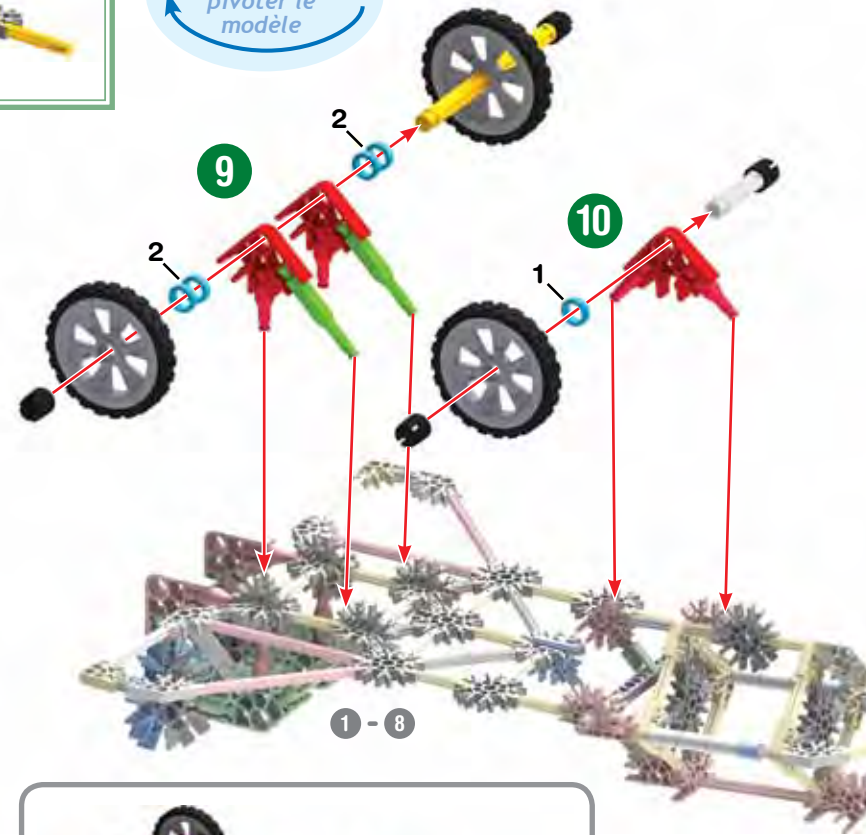

Dragster Dragster

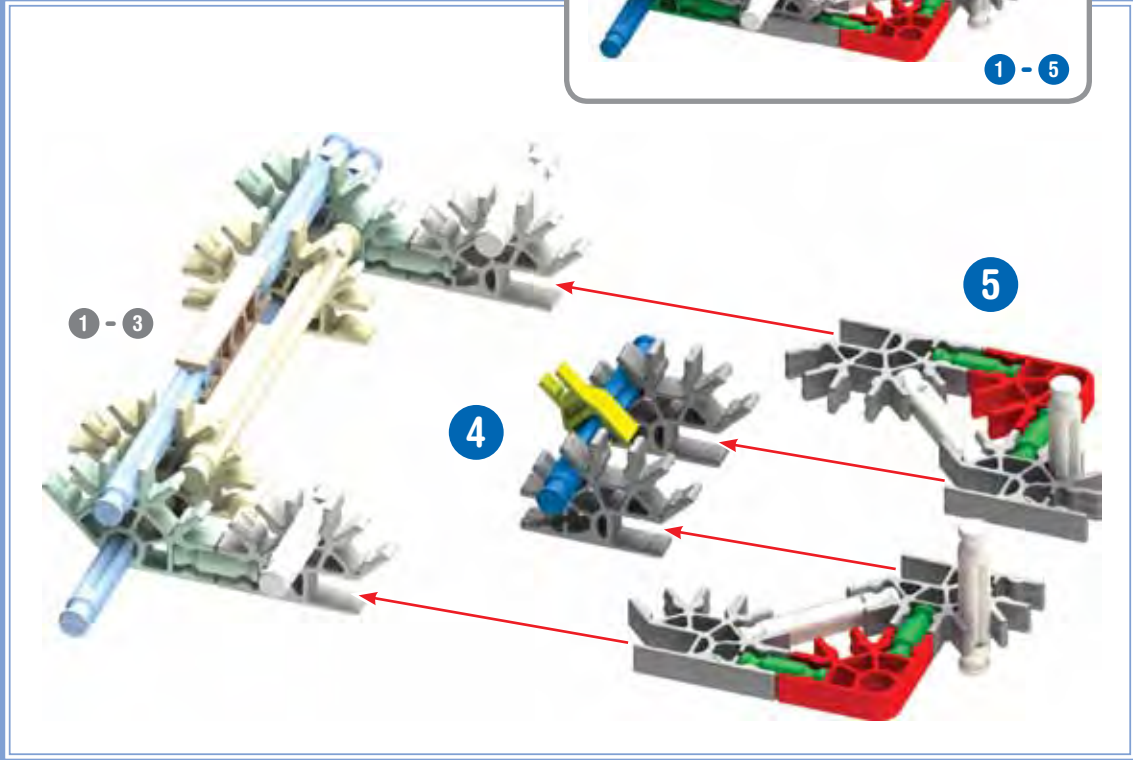
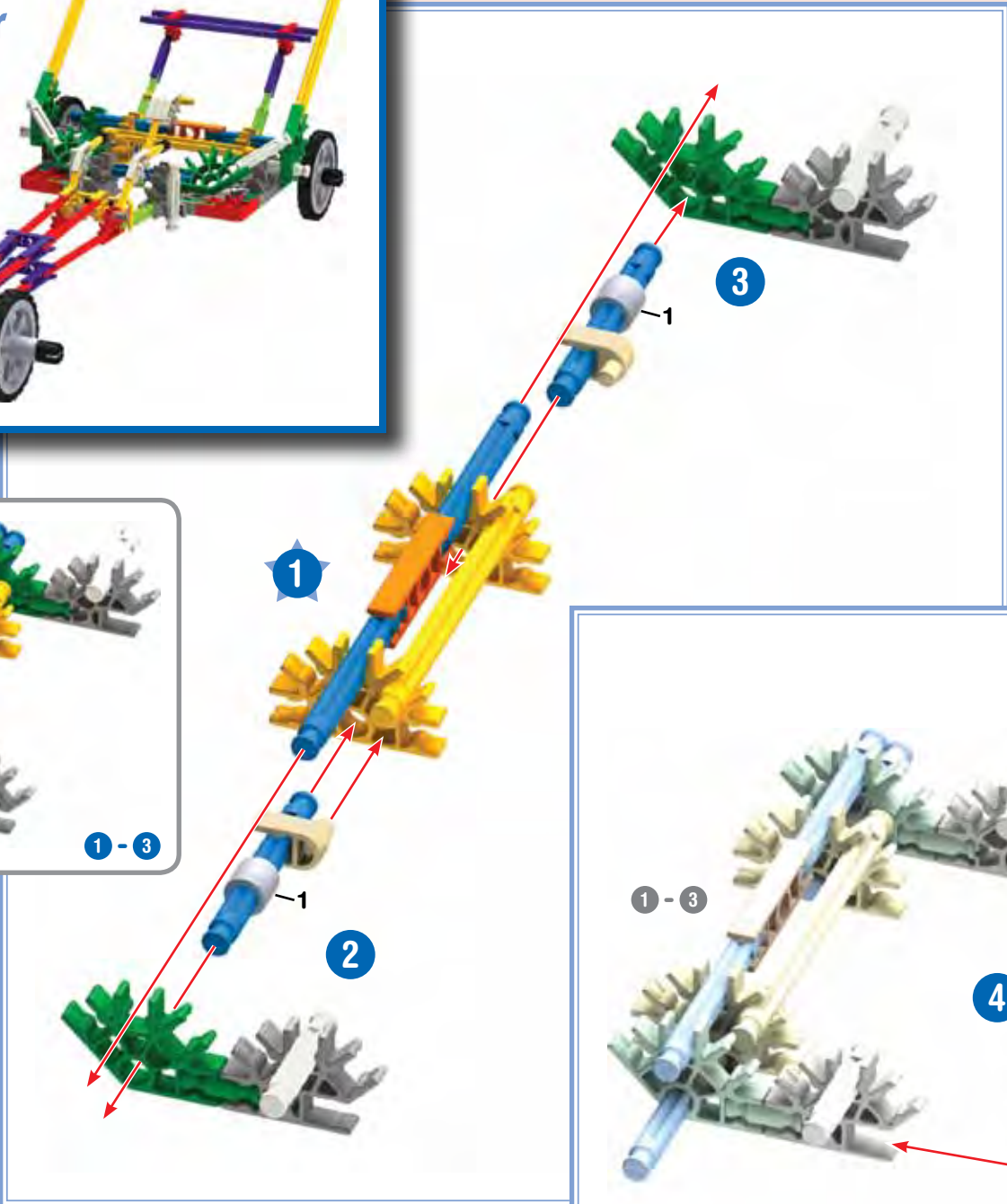

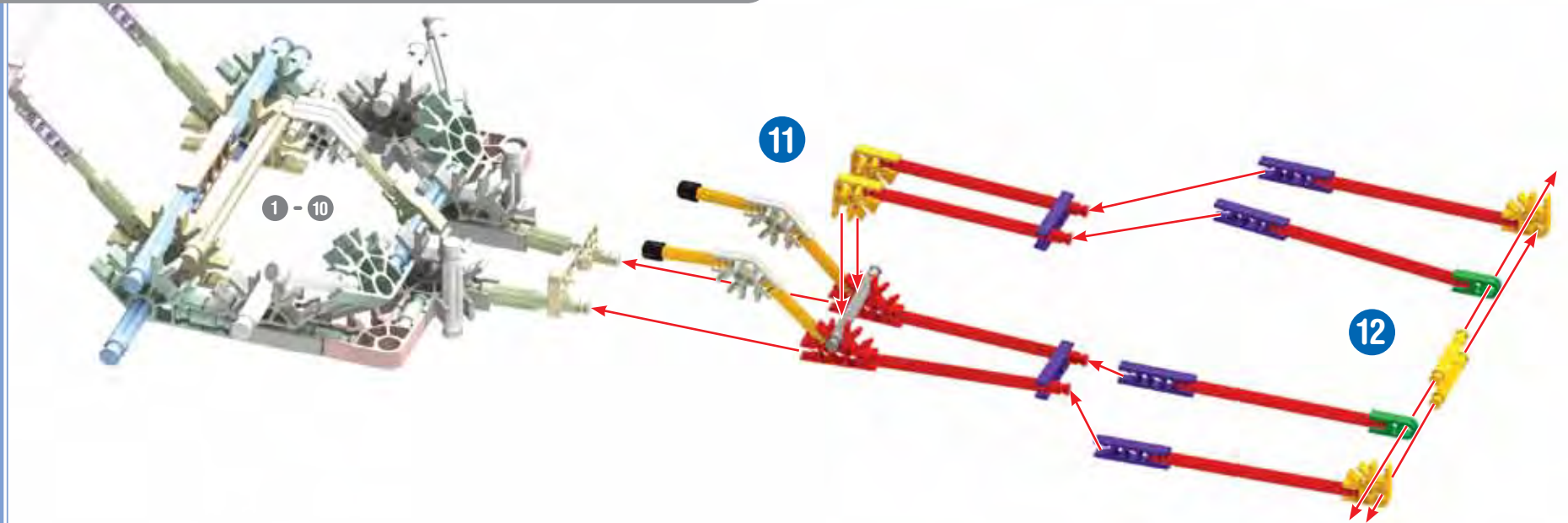
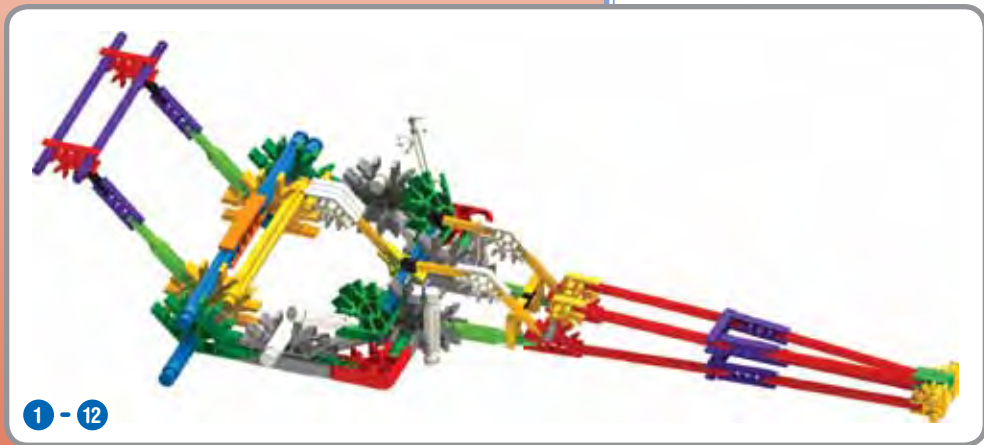
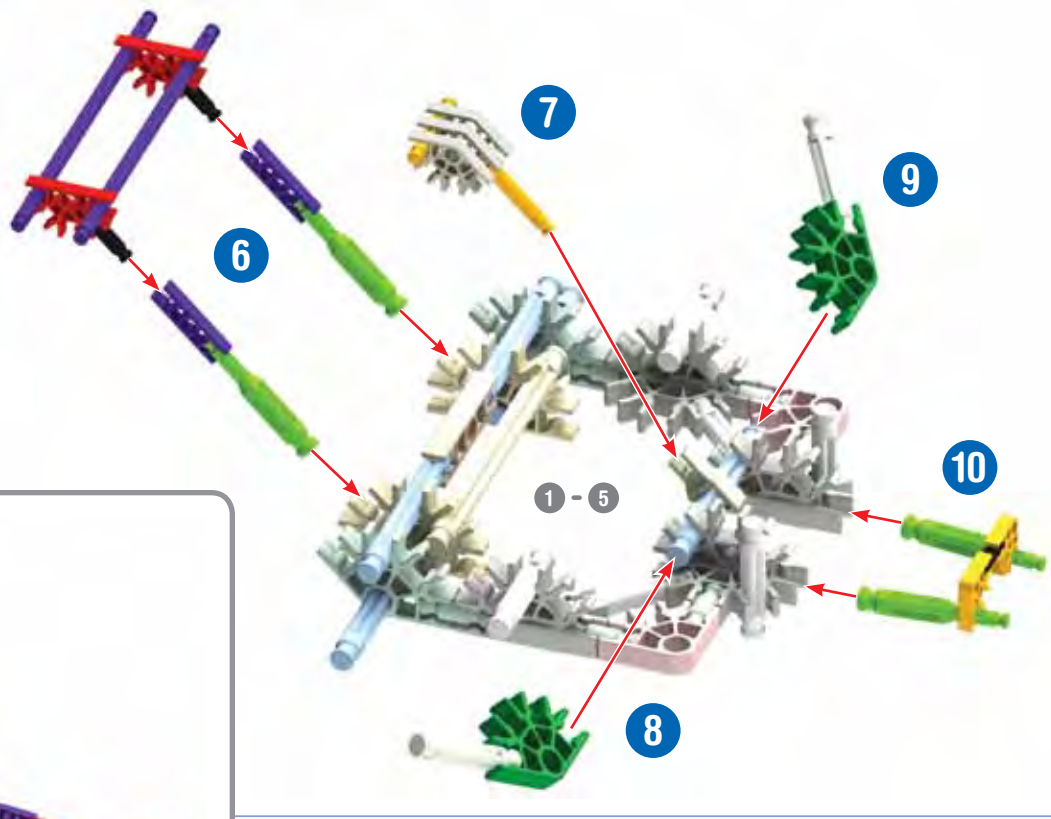

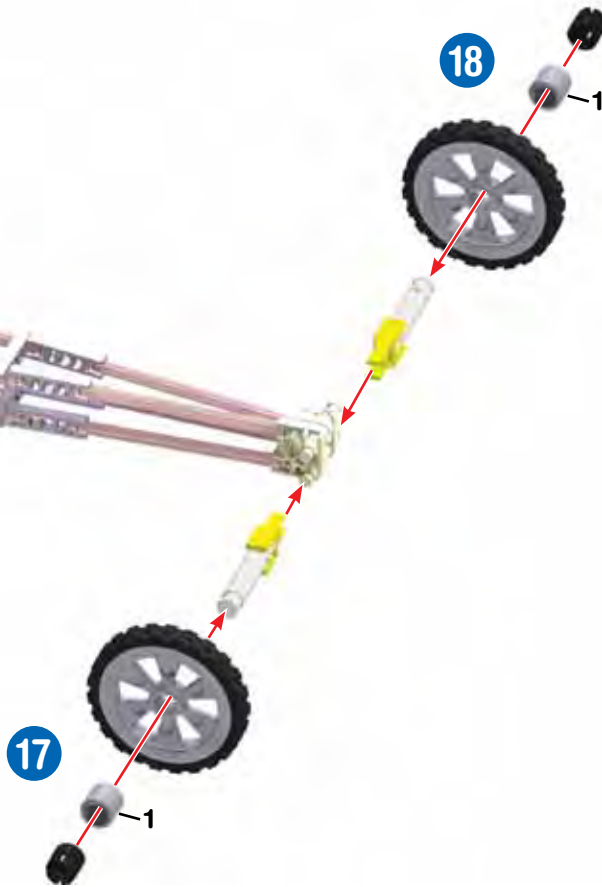
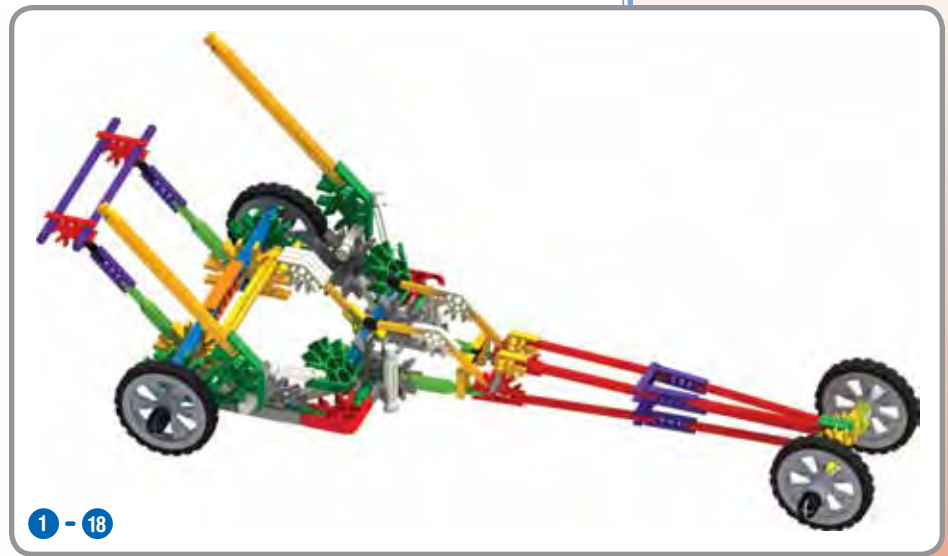
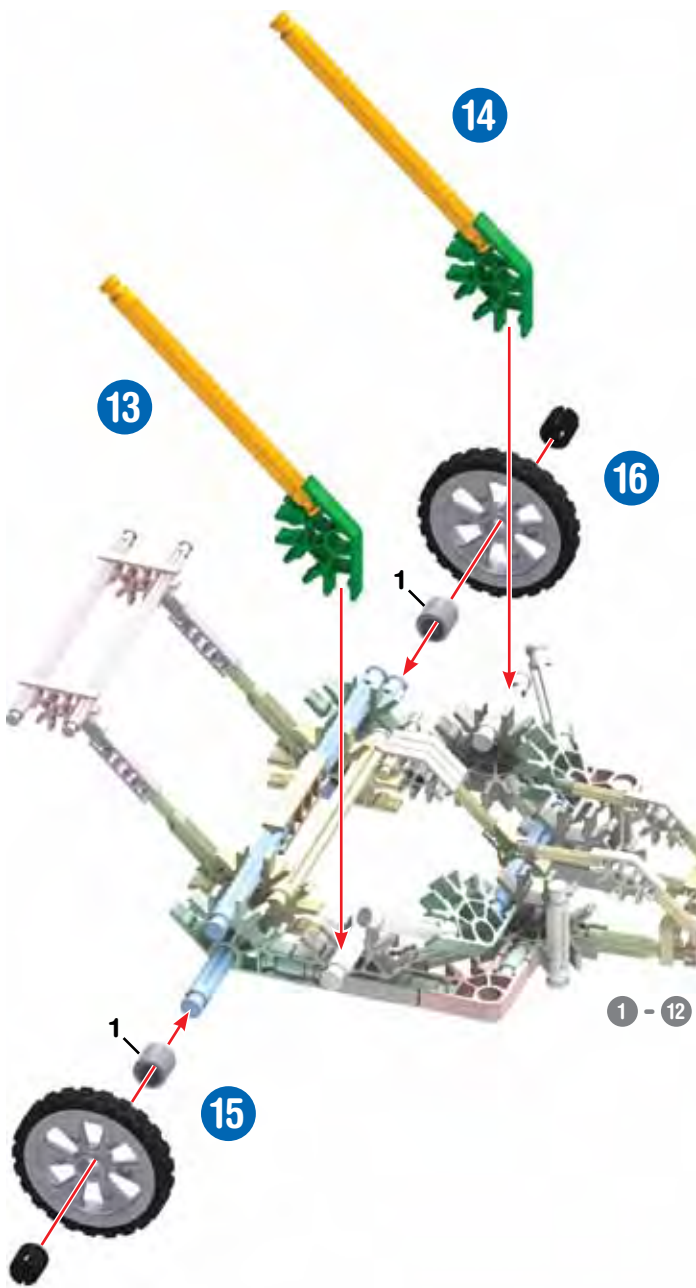

Dune Buggy

Dune Buggy

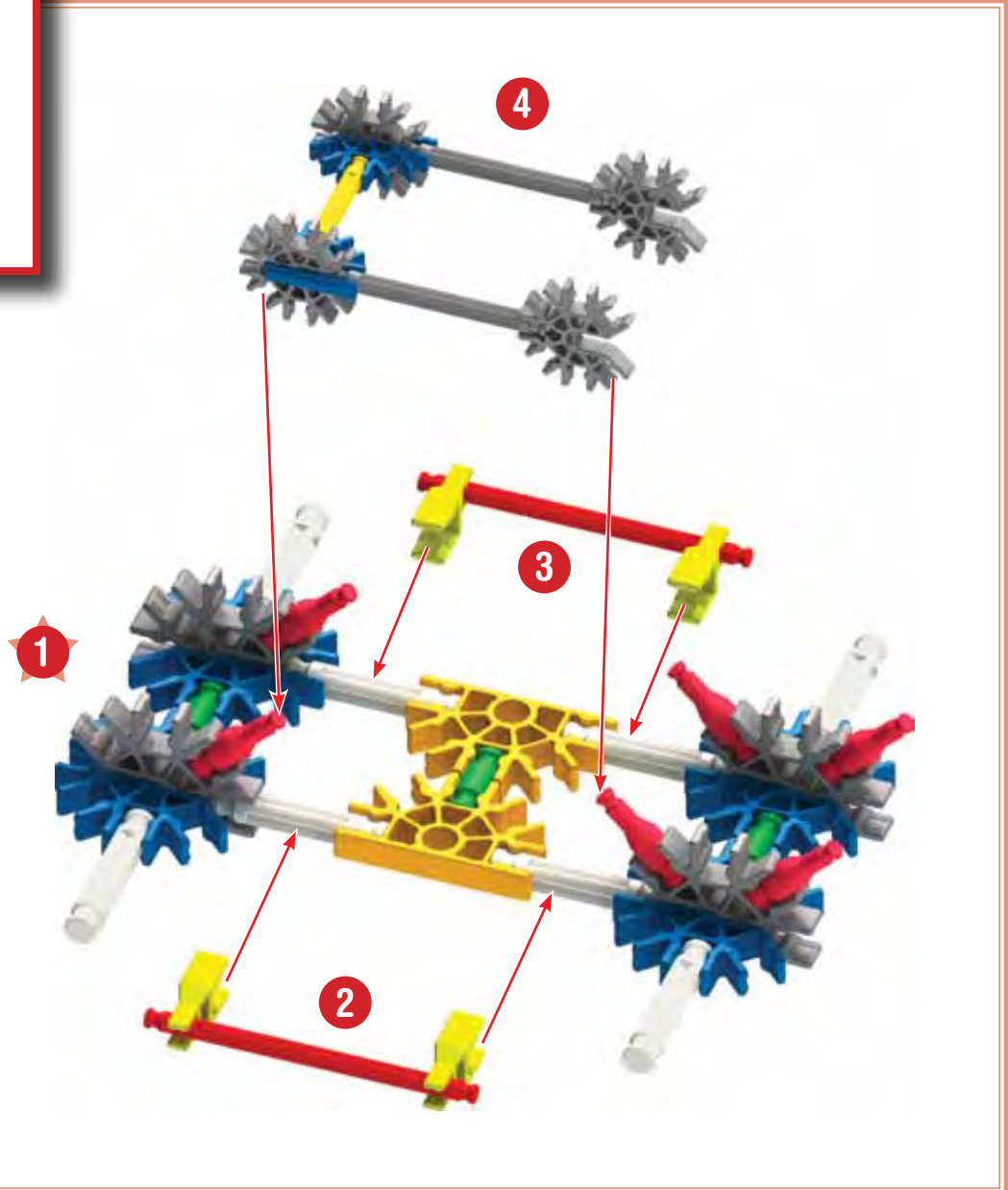
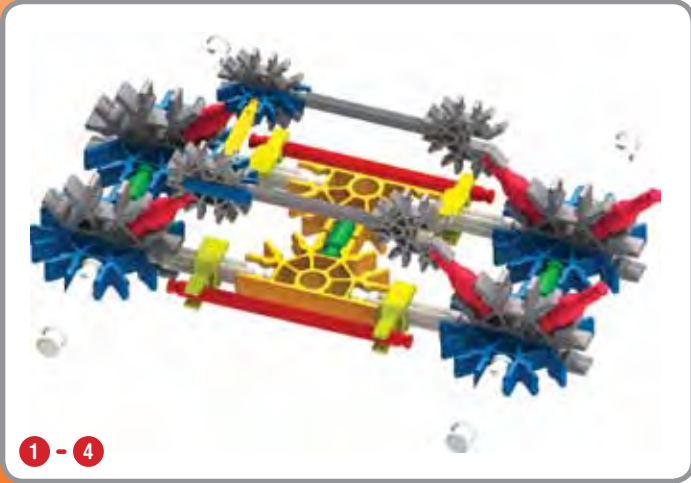
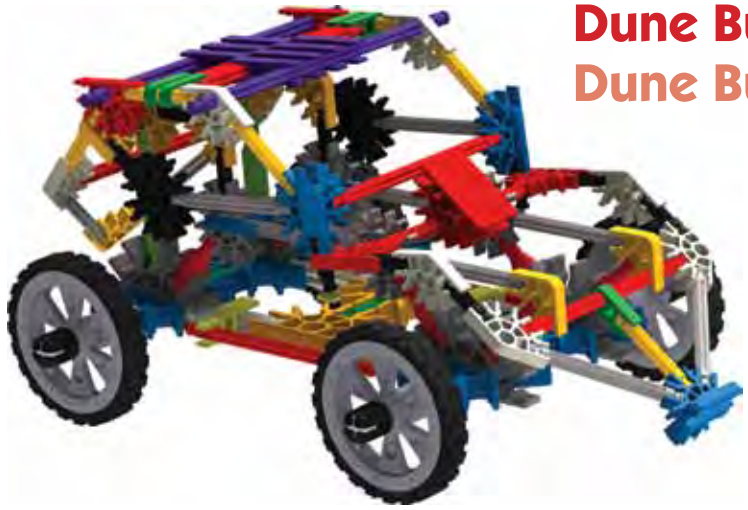

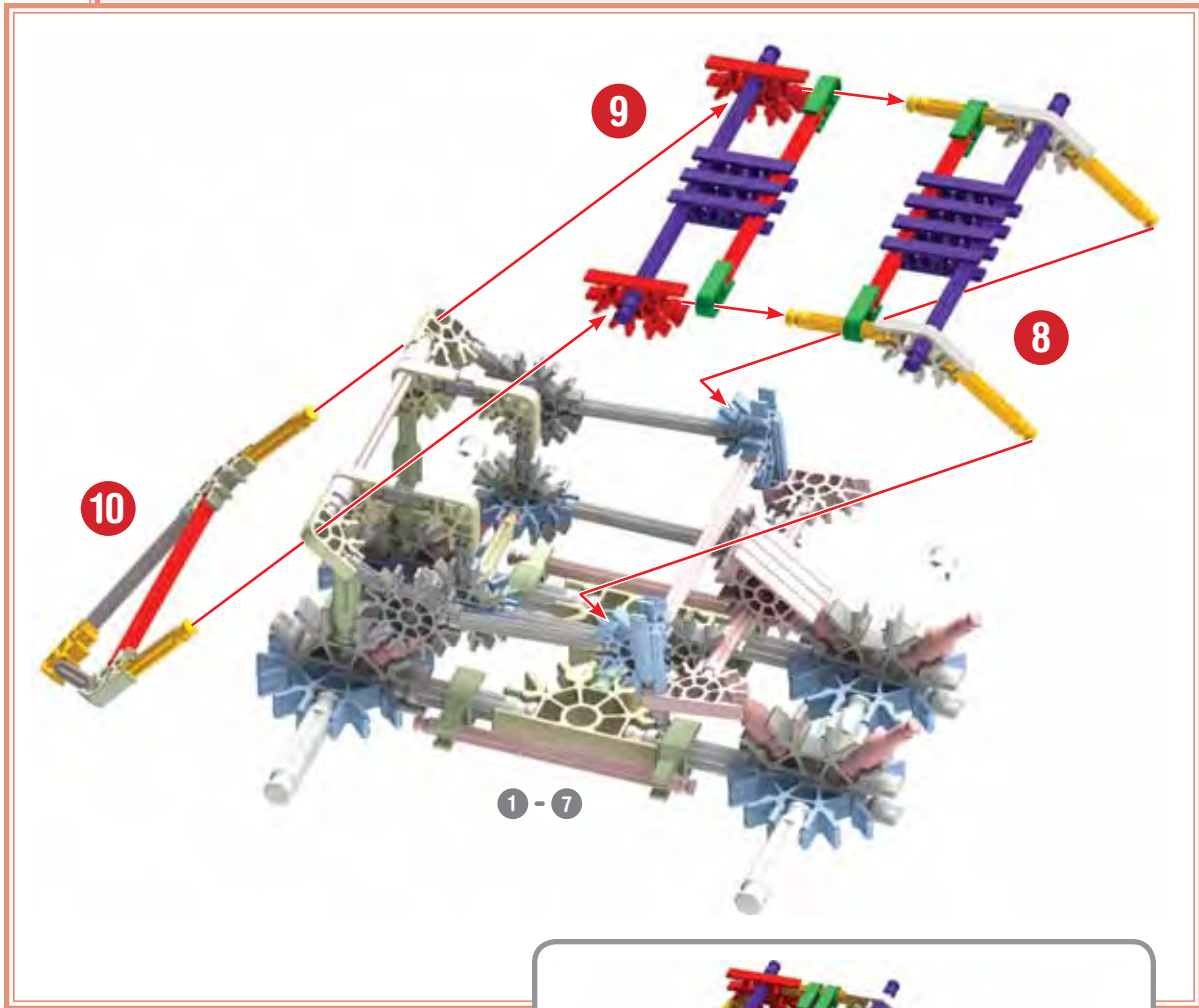
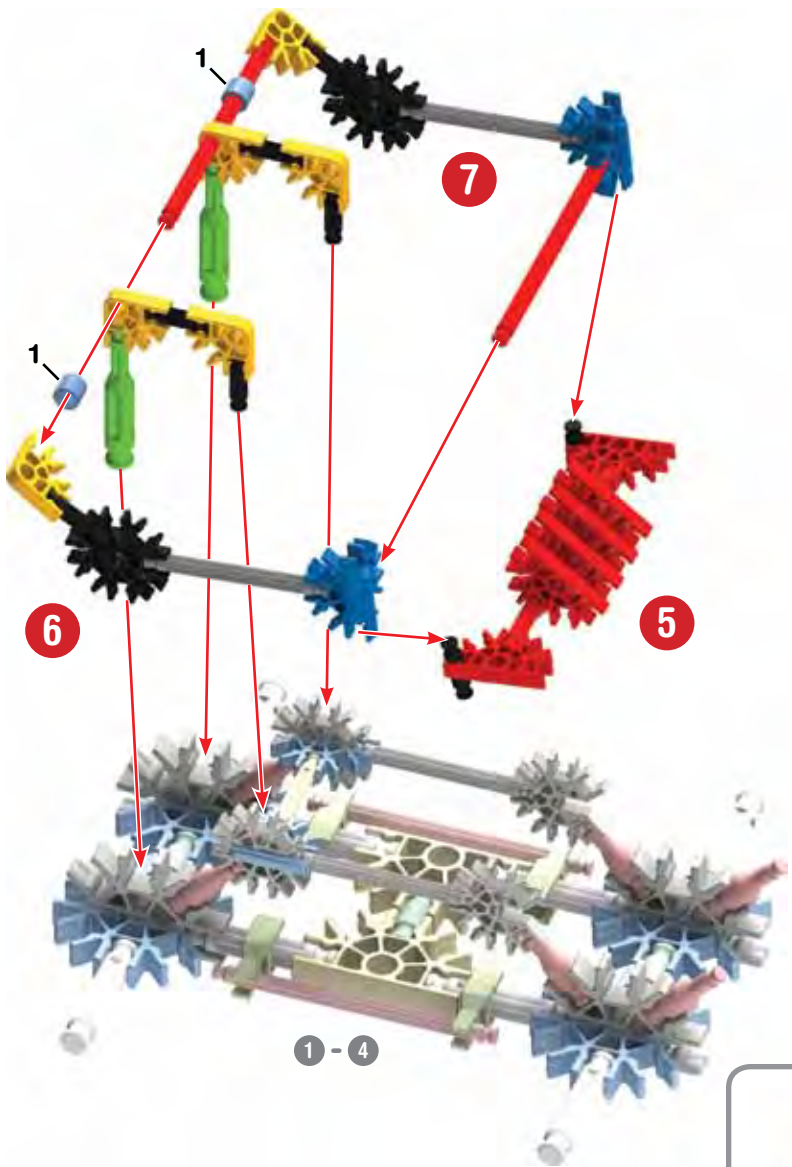

1 - 10

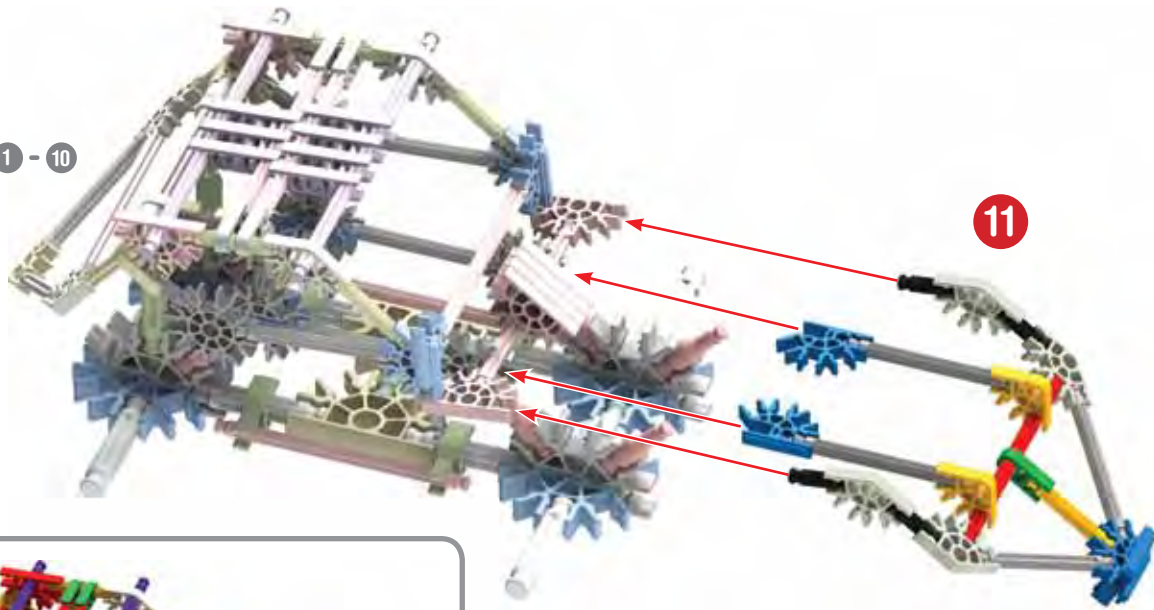

11



1 - 11



1 - 15

1 - 11

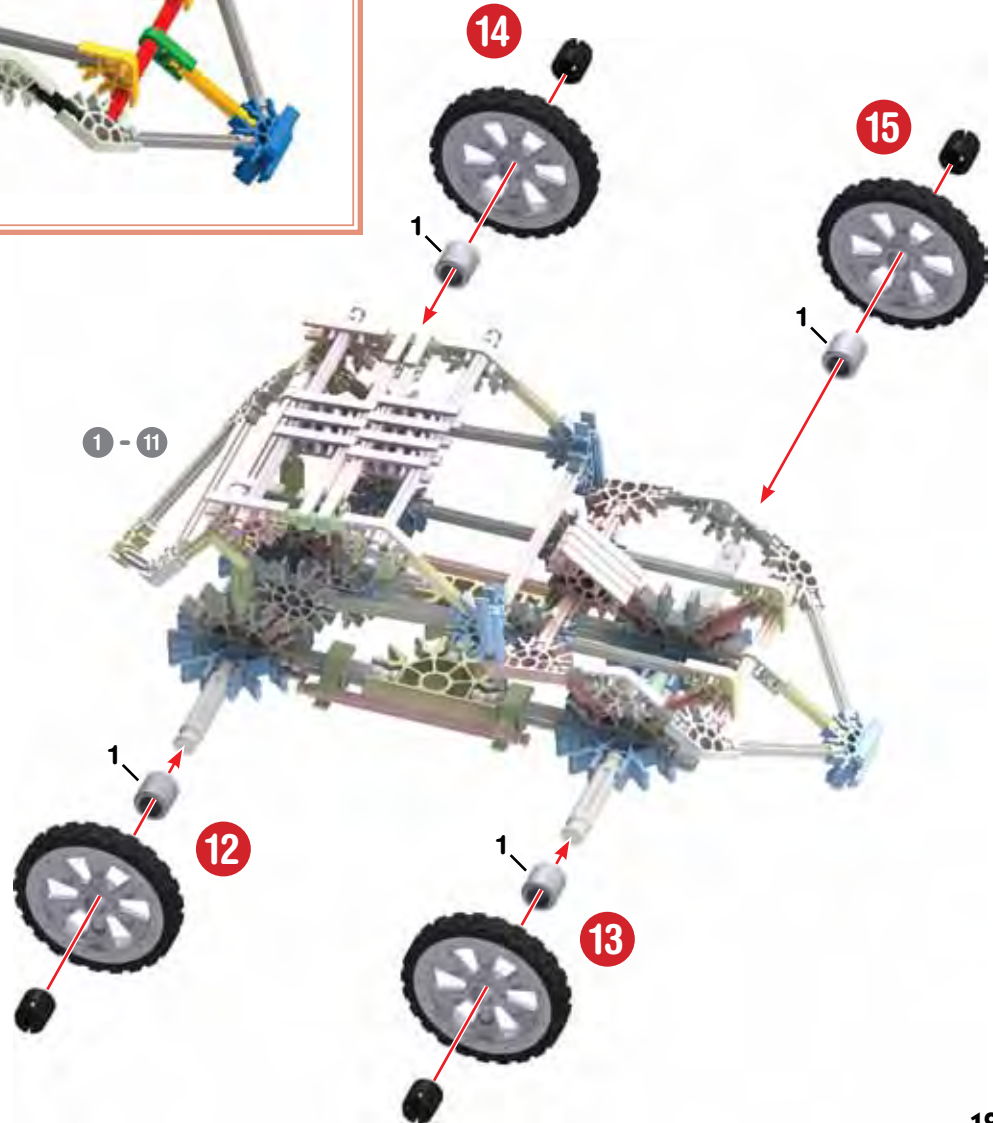

14

15

12

13

Dump Truck Camion-vidage

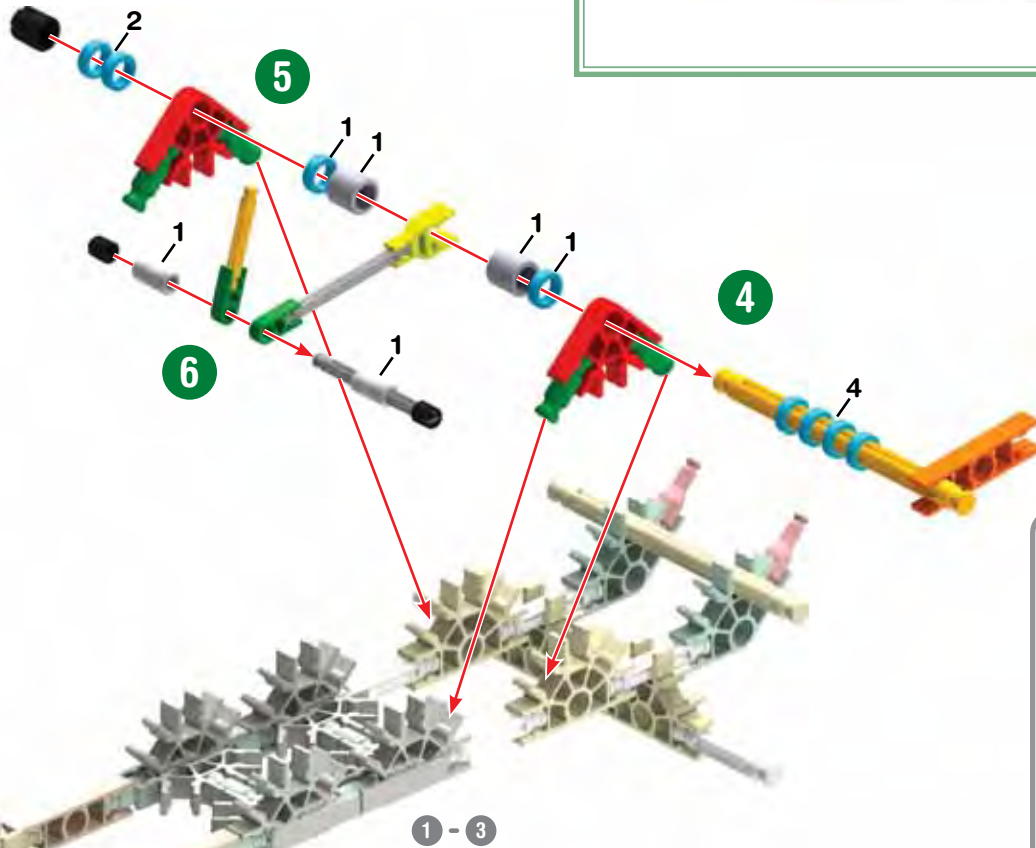
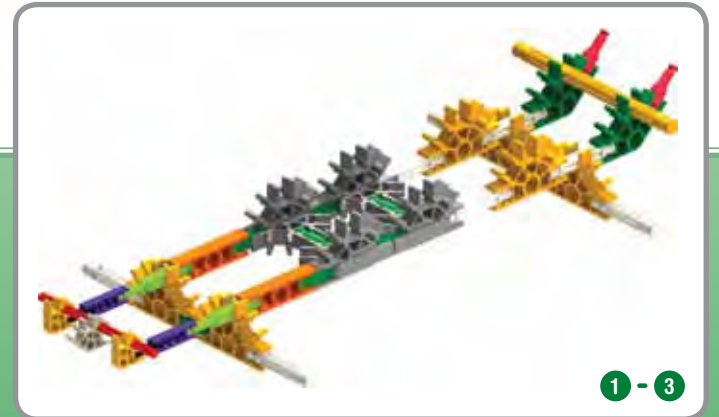
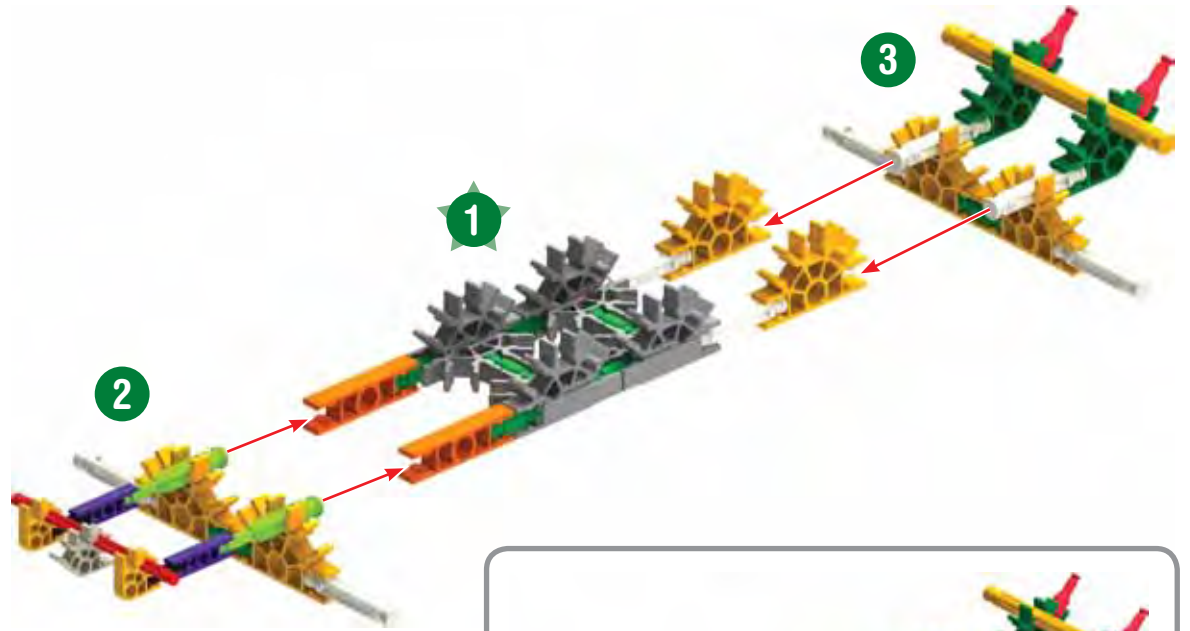

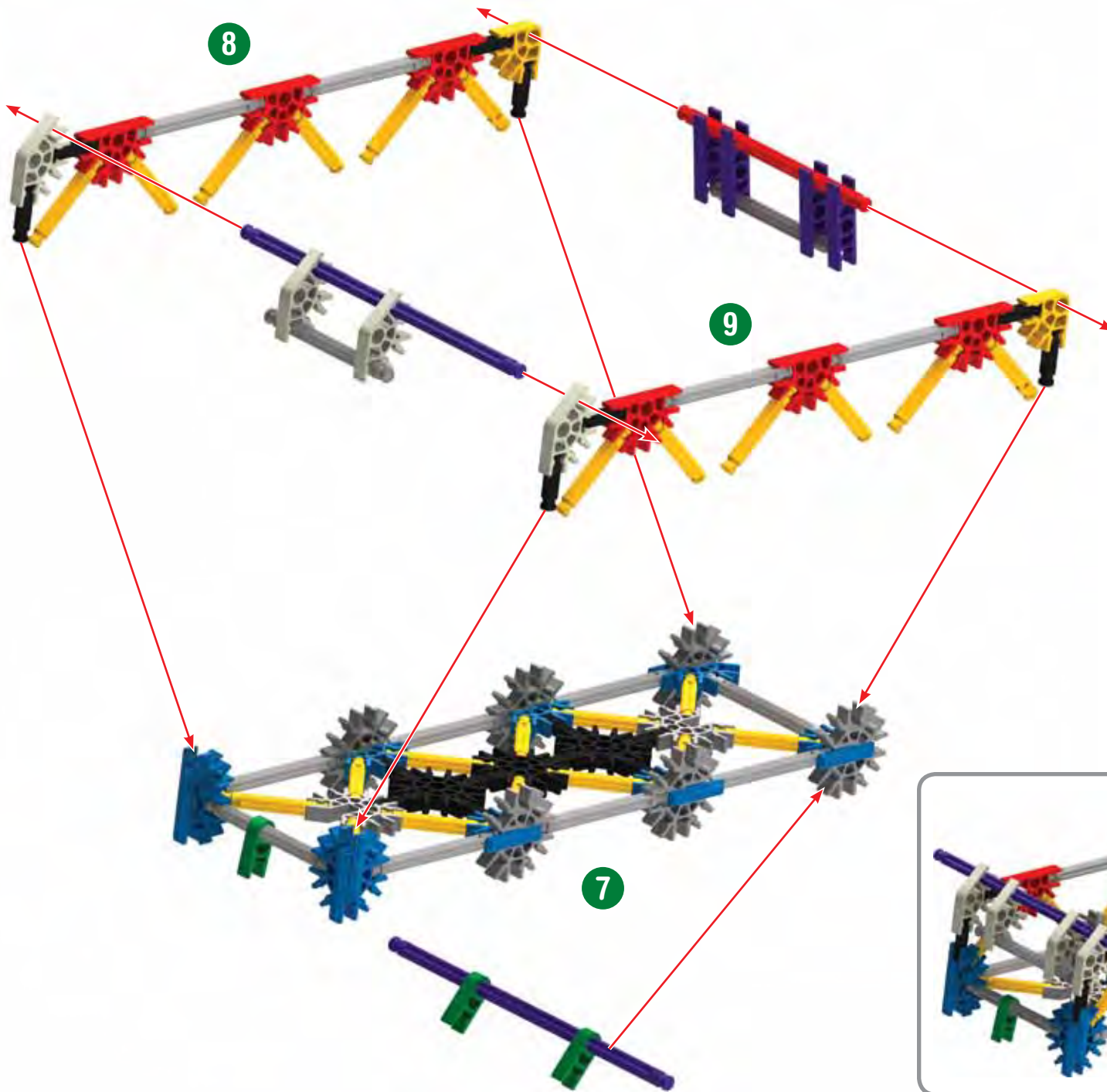

7 - 9

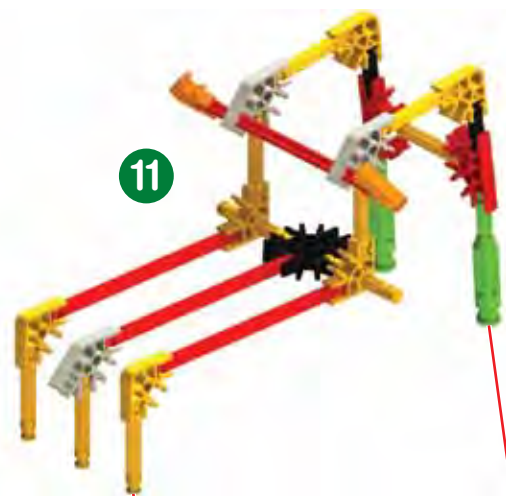

7 - 9

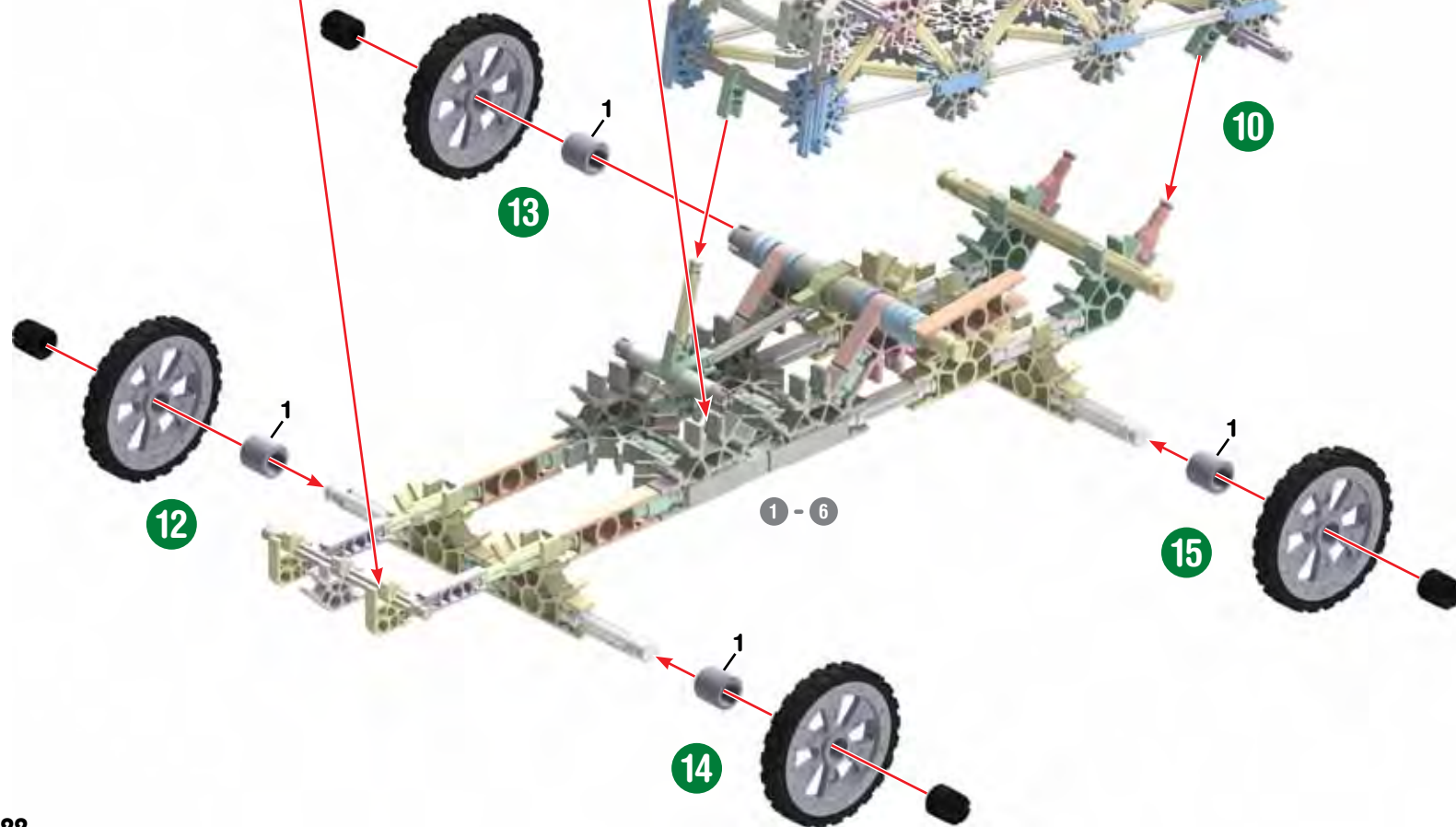

BUILDING IDEAS

For instructions of these models go to www.knex.com/instructions
and enter code **16482**

IDÉE DE CONSTRUCTION

Car les instructions de ces modèles vont à
www.knex.com/instructions et entrez dans le code **16482**

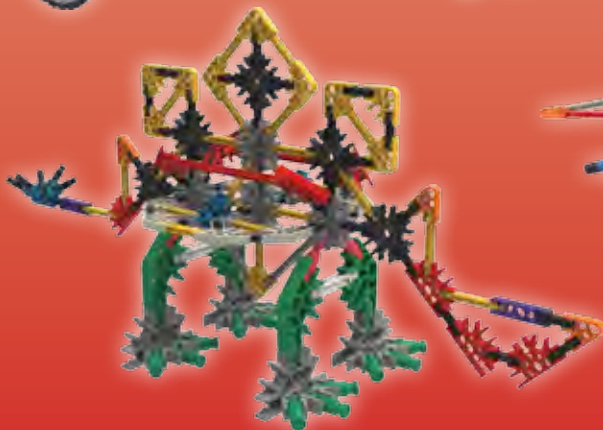
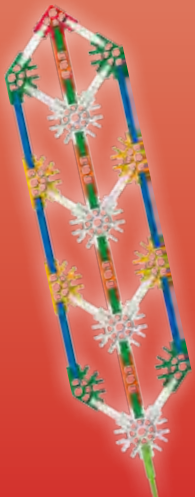
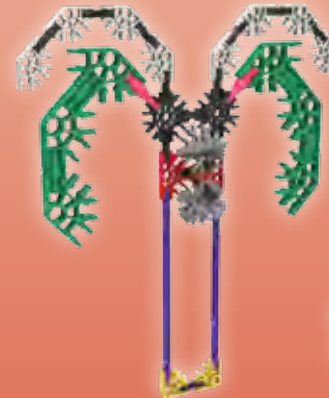
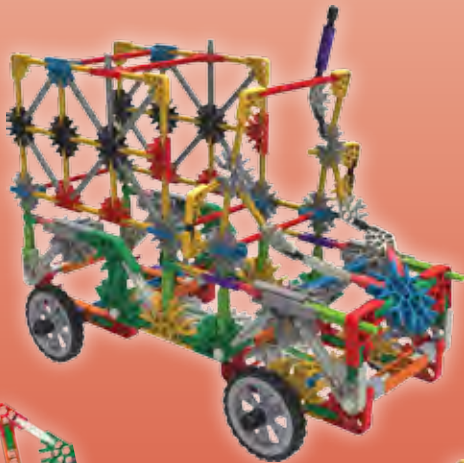
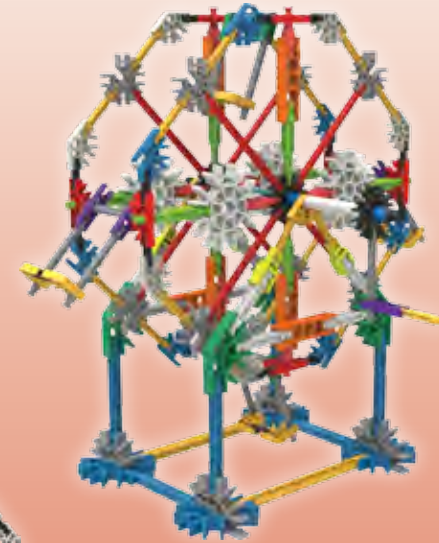

BUILDING IDEAS

For instructions of these models go to www.knex.com/instructions and enter code **16482**

IDÉE DE CONSTRUCTION

Car les instructions de ces modèles vont à www.knex.com/instructions et entrez dans le code **16482**

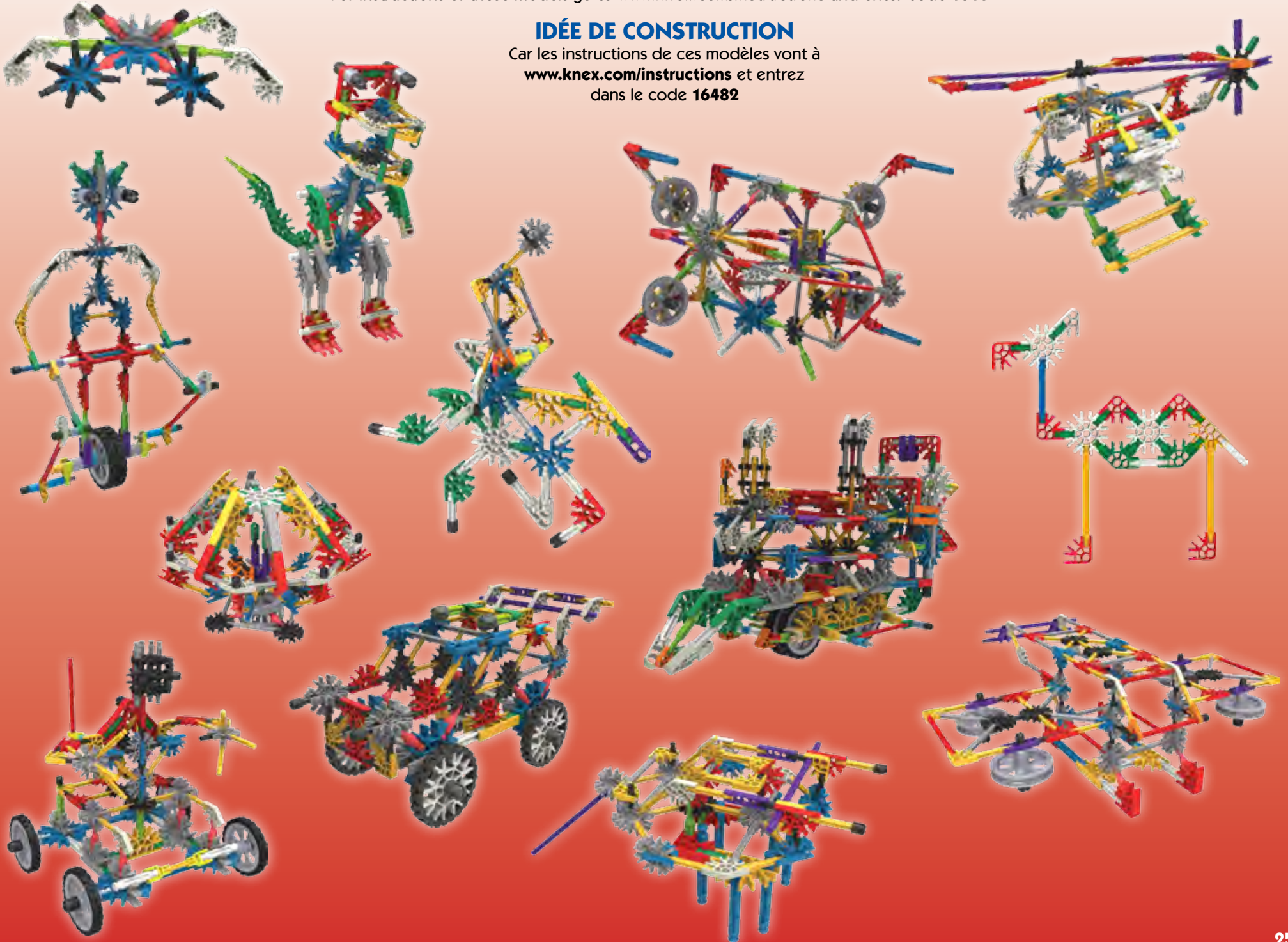

(ES) Español

(Página 2)

Lista de piezas

Antes de comenzar a construir, compare las piezas de su juego con las que se enumeran aquí. Si falta algo, llámenos o escríbanos utilizando la información que se encuentra en el reverso. ¡Estamos aquí para ayudarle!

Esenciales de construcción K'NEX

Para comenzar a construir

Para comenzar el modelo, encuentre el número 1 del paso y siga los números. Cada pieza tiene su propia forma y color. Observe las imágenes, encuentre las piezas que sean iguales a las que se muestran y conéctelas. Colocar el modelo en la misma dirección que se encuentra en las instrucciones le facilitará la construcción. Las flechas muestran en dónde se conectan las piezas, pero no todos los puntos de conexión tienen flechas. Las partes de color tenue son las que ya armó.

Espaciadores

Hay lugares en su modelo donde usted necesita utilizar espaciadores. Asegúrese de usar el color correcto y el número de espaciadores que se muestra en las instrucciones.

Conectores

Usted puede deslizar estos conectores especiales juntos. Empuje firmemente hasta que oiga un "clic". Preste atención a las instrucciones y la posición horizontal o verticalmente, exactamente como se muestran.

(Página 13)

Gire Modelo

(Página 23, 24, 25)

IDEAS DE CONSTRUCCIÓN

Para obtener instrucciones de los estos modelos vaya a www.knex.com/instructions y entre en el código **16482**.

(DE) Deutsch

(Seite 2)

Teileliste

Bevor du mit dem Bauen anfängst, solltest du prüfen ob die Teile in deinem Bausatz mit denen auf dieser Teileliste übereinstimmen. Falls etwas fehlt, rufe uns an oder schreibe uns (siehe Rückseite). Wir sind für dich da!

Grundlegende Bauanleitungen für K'NEX

Los geht's mit dem Bauen

Um mit dem Bauen deines Modells zu beginnen, suche die Nummer 1 und folge den laufenden Nummern. Jedes Teil hat seine eigene Form und Farbe. Schau dir einfach die Abbildungen an, such die Teile in deinem Bausatz, die so aussehen wie das, was du auf der Abbildung siehst und steck sie ineinander. Versuche, dein Modell beim Zusammenbauen so zu orientieren, dass es in die gleiche Richtung weist, wie es in den Anleitungen beschrieben und gezeigt wird. Blasse Farben weisen darauf hin, dass dieser Streckenabschnitt bereits zusammengebaut ist.

Abstandsstücke

An manchen Stellen in deinem Modell musst du Abstandsstücke einbauen. Achte darauf, die richtige Farbe und Anzahl von Abstandsstücken wie in der Anleitung gezeigt zu verwenden.

Verbindungsstücke

Verbindungsstücke haben besonders lange Schlitzte. Wie du auf der Abbildung sehen kannst, lassen sie sich ineinander schieben. Achte beim Aneinanderfügen dieser Teile darauf, dass du ein Klickgeräusch hörst. Erst dann sind die Teile fest miteinander verbunden.

(Seite 13)

Grehe das Modell

(Seite 23, 24, 25)

BAUVORSCHLÄGE

Für Anweisungen dieser Modelle gehen sie zu www.knex.com/instructions und geben sie Code **16482** ein.

(IT) Italiano

(Pagina 2)

Elenco delle parti

Prima di cominciare a costruire, accertati di confrontare le parti che sono nel tuo set con l'elenco delle parti qui. Se ne manca una chiamaci o scrivici usando le informazioni che sono nella retrocopertina. Noi siamo qui per aiutarti!

Istruzioni di base per costruire con K'NEX

Comincia a costruire

Per iniziare il modello, cerca il numero 1 e segui i numeri. Ogni pezzo ha una sua forma e un suo colore. Guarda la figura, trova i pezzi corrispondenti nel set e mettili insieme. Cerca di tenere il modello nella stessa direzione della figura e in tal modo sarà più semplice attaccare i pezzi nei posti giusti. I colori spenti ti dicono che questa sezione è già stata costruita. Dovrai collegare la nuova sezione al punto indicato dalla punta della freccia.

Spaziatori

Ci sono punti nel tuo modello a cui dovrai aggiungere spessori. Accertati che usate il colore corretto e il numero di spessori mostrati nel' istruzioni.

Connettori

Poi scorrere questi speciale connettori insieme. Spingi con forza finche senti un "clic". Fare molto attenzione al' istruzione e posizionare questi orizzontale o in verticale esattamente come sono mostrati.

(Pagina 13)

Gira il Modello

(Pagina 23, 24, 25)

IDEE DI COSTRUZIONE

Per istruzioni di questi modelli vai a www.knex.com/instructions e' inserire il codice **16482**.

(PT) Português

(Página 2)

Lista das peças

Antes de começar a montar, compare as partes do seu conjunto com as partes enumeradas aqui. Se houver algo que estiver faltando, ligue ou escreva para nós usando as informações na capa de trás. Estamos aqui para servir e ajudar

Instruções básicas para montar o K'NEX

Comece a montar

Para começar a montar o modelo, encontre o número do passo e siga os números. Cada peça tem a sua própria forma e cor. Estude as ilustrações, encontre as peças que coincidem com o que você estiver vendo e conecte-as. Fique de frente para o modelo, na mesma direção que as figuras mostradas nas instruções. As setas mostram onde as peças se conectam, mas nem todos os pontos de conexão têm setas. As partes com cores desbotadas são as que você já montou.

Espaçadores

Existirão certos pontos no teu modelo que necessitam a colocação de espaçadores. Assegura-te que os contas cuidadosamente.

Conectores

É muito importante que posicione os conectores numa direção específica. Junta as partes simultaneamente e com firmeza até ouvires um “estalido”. Presta muita atenção às instruções e coloca estes conectores horizontal ou verticalmente, exactamente conforme se mostra nas ilustrações.

(Página 13)

Gire Modelo

(Página 23, 24, 25)

IDEIAS DE CONSTRUÇÃO

Para obter instruções destes modelos vá em www.knex.com/instructions e digite o código **16482**.

(NL) Nederlands

(Bladzijde 2)

Onderdelen Lijst

Voordat u begint met bouwen, moet u de onderdelen vergelijken de set met de onderdelen lijst hier. Als er iets ontbreekt, bel of schrijf ons gebruik van de informatie op de achterkant. We zijn hier om u te helpen!

Basisstappen voor K'NEX bouwen

Begin te bouwen

Om met je model te beginnen, vind eerst het nummer 1 en volg de nummers. Elk stuk heeft zijn eigen vorm en kleur. Kijk gewoonweg naar de afbeeldingen, vind de overeenstemmende stukken terug in je geheel en maak e aan mekaar vast. Tracht je model in dezelfde richting te plaatsen als de aanwijzingen terwijl je bouwt en monteert. De vervaagde kleuren duiden aan dat dit deel reeds is opgebouwd. Gelieve het nieuwe deel vast te koppelen op de plaats aangeduid door de pijlen.

Afstandhouders

Op bepaalde plekken van je model moet je afstandhouders gebruiken. Zorg dat je het juiste aantal afstandhouders gebruikt, zoals wordt getoond in de instructies.

Verbindingsstukken

Je kunt deze speciale verbindingstukken in elkaar steken. Duw ze stevig tegen elkaar aan tot je een ‘klik’ hoort. Let goed op de instructies en plaats ze horizontaal en verticaal, precies zoals wordt getoond.

(Bladzijde 13)

Draai Model

(Bladzijde 23, 24, 25)

BOUWIDEEËN

Voor instructies van deze modellen naar www.knex.com/instructions en vul de code **16482**.

**55 MODEL
SUPER VALUE
BUILDING SET**

**55 MODÈLE
SUPER VALEUR
JEU DE CONSTRUCTION**

**CLOCK WORK™ HORLOGE
ROLLER COASTER MONTAGNES
BUILDING SET RUSSES
JEU DE CONSTRUCTION**



**INFINITE
JOURNEY™
ROLLER COASTER
BUILDING SET**

**VOYAGE INFINI
MONTAGNES
RUSSES
JEU DE
CONSTRUCTION**

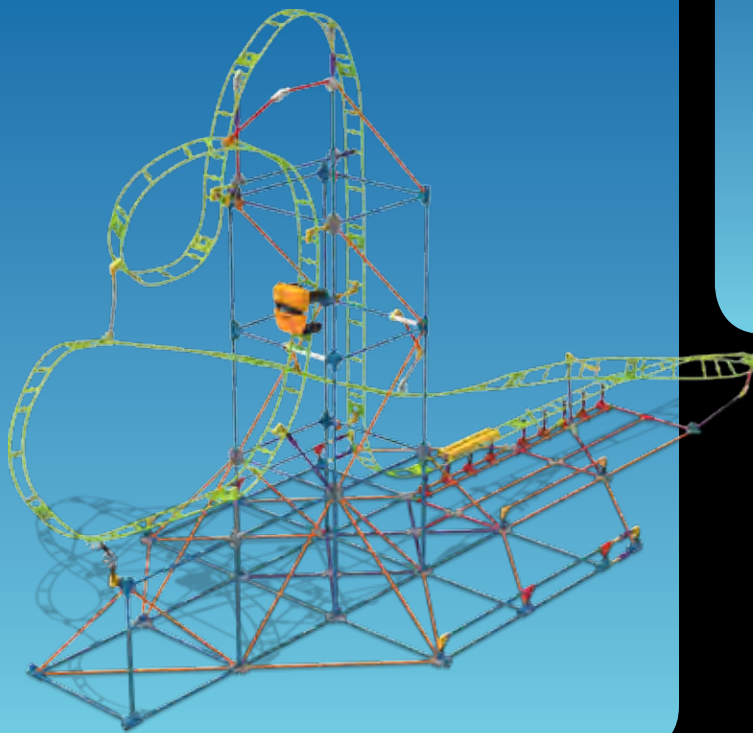

**REVOLUTION™ RÉVOLUTION
FERRIS WHEEL GRANDE ROUE
BUILDING SET JEU DE
CONSTRUCTION**



§ Sold separately.
Vendus séparément.
Se venden por separado.
Separat erhältlich.
Venduti separatamente.
Vendidos separadamente.
Afzonderlijk verkocht.

©2016 K'NEX Limited Partnership Group, P.O. Box 700, Hatfield, PA 19440-0700; 1-800-KID-KNEX (USA/Canada/États-Unis/EE.UU.); email@knex.com; knex.com. K'NEX UK Ltd., P.O. Box 3083, Reading RG1 9YQ, England. For customers outside the USA/Canada please contact your local distributor at www.knex.com/distributors.

(FR) Pour les clients en dehors du Canada et des États-Unis, veuillez contacter votre distributeur local que vous pouvez trouver sur www.knex.com/distributors

(ES) El cliente que no vive en EE.UU./Canadá se pone en contacto con el distribuidor local. Encuentre la información para el distribuidor local en www.knex.com/distributors

(EN) K'NEX and Building Worlds Kids Love are registered trademarks of K'NEX Limited Partnership Group.
(FR) K'NEX et Building Worlds Kids Love sont des marques déposées de K'NEX Limited Partnership Group.
(ES) K'NEX y Building Worlds Kids Love son marcas registradas de K'NEX Limited Partnership Group.

(EN) Product & colors may vary. Most models can be built one at a time.
(FR) Le produit et ses couleurs peuvent varier. Les différents modèles ne peuvent être construits qu'un par un.
(ES) El producto y los colores pueden variar. La mayoría de los modelos se pueden construir uno a la vez.
(DE) Produkte und Farben können abweichen. Die meisten Modelle können immer nur einzeln gebaut werden.
(IT) Prodotti e colori possono differire. La maggior parte dei modelli si può costruire autonomamente.
(PT) O produto e as cores podem variar. A maioria dos modelos pode ser montado um de cada vez.
(NL) Product en kleuren kunnen variëren. De meeste modellen kunnen uitsluitend een voor een worden gebouwd.

 facebook.com/knex

 [@knexbrands](https://instagram.com/knexbrands)

116482-V1-06/16