

K'NEX

425

pcs
pzs

Super Value Tub



www.KNEX.com



WARNING:

CHOKING HAZARD - Small parts.
Not for children under 3 years.



AVERTISSEMENT:

DANGER D'ÉTOUFFEMENT - Pièces de petite taille.
Ne pas donner aux enfants de moins de 3 ans.

7-14

Building System
Système De Construction

About the Set	2	Sailboat	29
What's Included	2	Ocean Liner	29
Building with K'NEX	3	Fish	30

Motorized Models!

Sand Racer	4	Picture Frame 1	31
Windmill	5	Picture Frame 2	32
Wind-Up Ferris Wheel	8	Ring Toss Game	33
Turbo Racer	10	Tractor with Harrow	34
3-Wheeler	11	Helicopter	35
Dragster	12	Chuck Wagon	36
Star Ship	14	Space Shuttle	38
Robot	16	Formula Car	40
Tilt-A-Whirl	18	Catamaran	42
Eggbeater Ride	20	Basketball Game	43
Space Ship Ride	22	Sport Bike	44
Grandfather Clock	25	Construction Vehicle	46
		Boss Vehicle	48

More Amazing Models!

Turtle	28	(F) French Language	52
Castle	28	(E) Spanish Language	53
		(D) German Language	54
		(NL) Dutch Language	55

About the Set

Do you love to build? This building set is specially for you! Try your hand at **30** amazing models using these step-by-step instructions, or use your imagination to build creations of your own! There's even a motor with pull-back action to bring your creations to motorized life! There's something for everyone, from beginners through K'NEXperts! With the **K'NEX 425-PC TUB**, you'll have **BIG** building fun!

Before you start building, be sure to compare the parts in your tub with the parts listed below. If anything is missing, check out the back cover of this instructions booklet for how to contact us. We're here to help!





1 Hi! I'm your K'NEX building buddy. The instructions in this book will help you build 30 models to start you on your way to being a K'NEXpert! You'll find models for three levels of building.

Look for me before each build, holding up a sign to show you how difficult each model will be,... check this out:



Friendly Challenge



Moderate Challenge



Greater Challenge

Ready, Set, Build

To begin your model, find the  and follow the numbers. Each piece has its own shape and color. Just look at the picture, find the pieces in your set that match what you see, and snap them together. Try to hold your

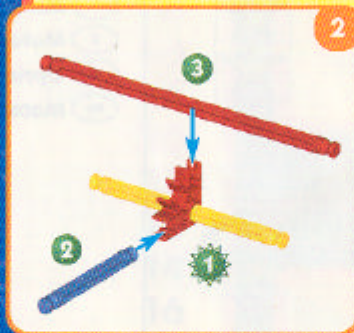

model in the same direction as in the picture so you'll attach your pieces to the right place.

Movin' On

The faded colors tell you this section is already built. You'll want to connect the new section to the place where the arrows are pointing. This piece will be in full color.

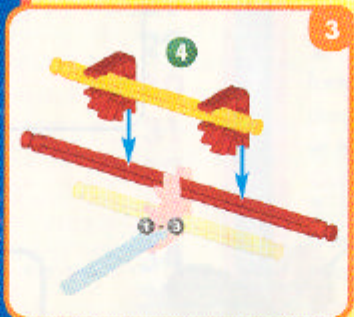

Make It Go



4 Wind the Spring Motor until you hear a clicking sound, then release.

Spacers

There are places in your model where you need to add blue Spacers. Be sure to count them carefully.

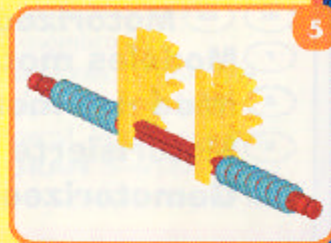

Connectors

It's very important to position blue and purple Connectors in a specific direction. Pay close attention to the instructions, and position these Connectors horizontally or vertically exactly as they are shown. Push together tightly until you hear a "click".

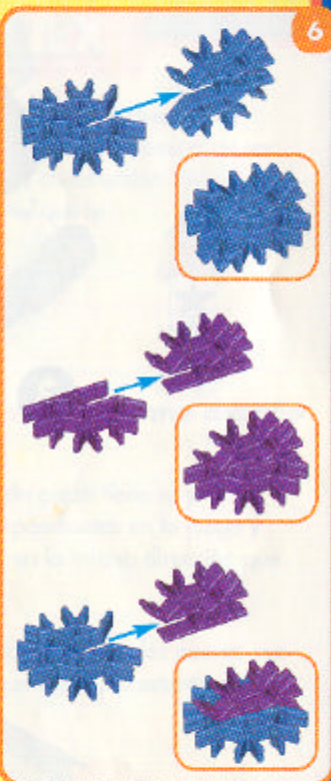

CAUTION:

Keep hair, fingers, face and clothing away from moving parts.

- (US) (GB) **Motorized Models!**
- (F) **Modèles motorisés !**
- (E) **¡Modelos motorizados!**
- (D) **Motorisierte Modelle!**
- (NL) **Gemotorizeerde modellen!**

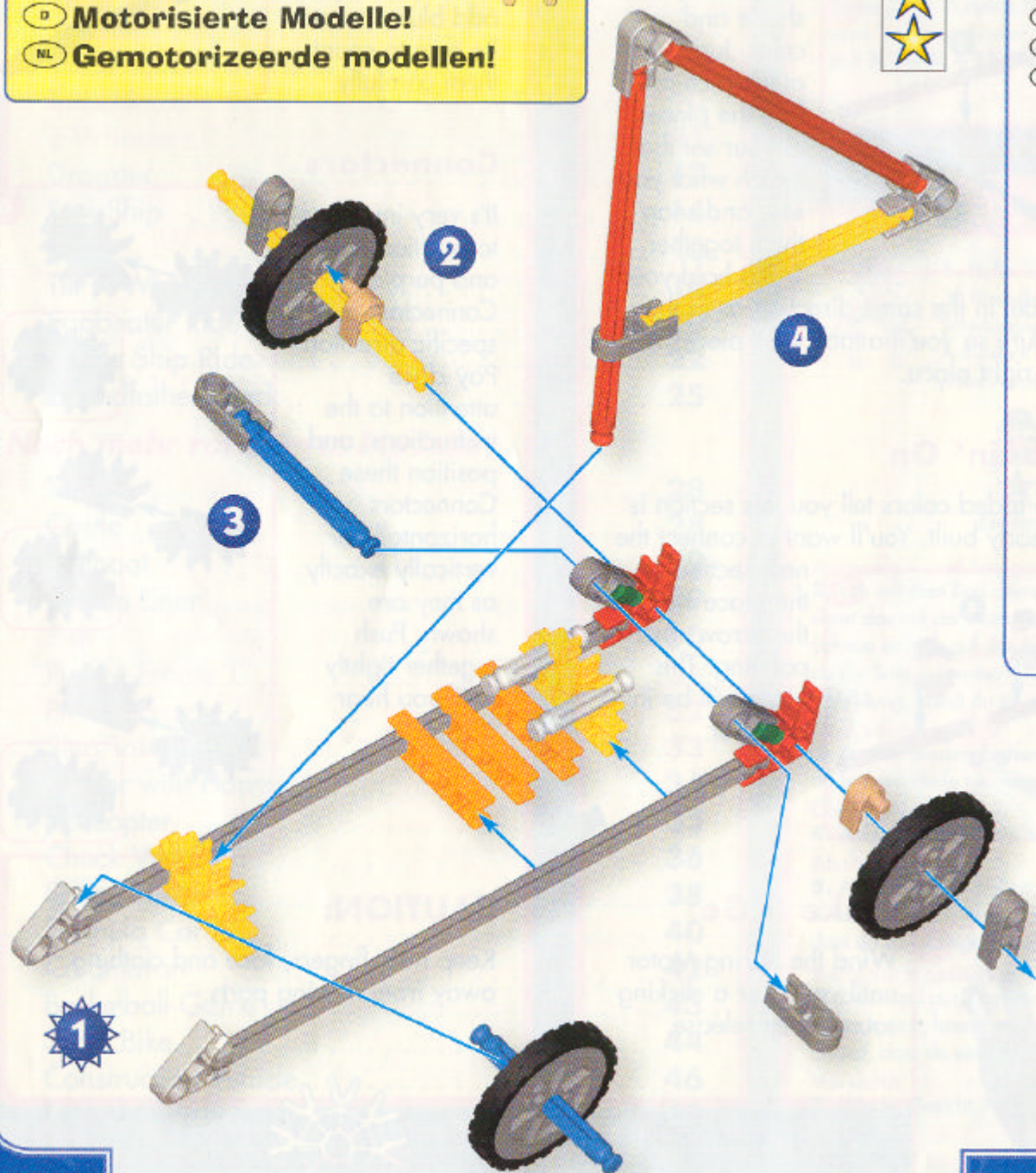

- (US) (GB) **Optional Motor Installation**
- (F) **Moteur optionnel**
- (E) **Motor optativo**
- (D) **Optionaler Motor**
- (NL) **Motor optioneel**

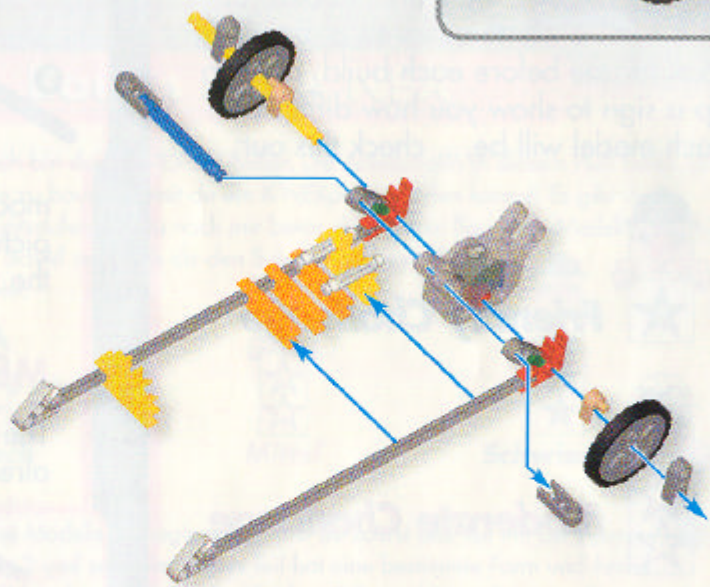
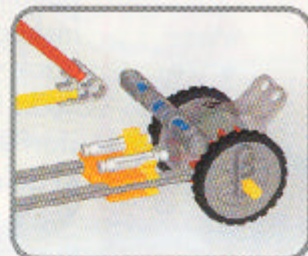



1

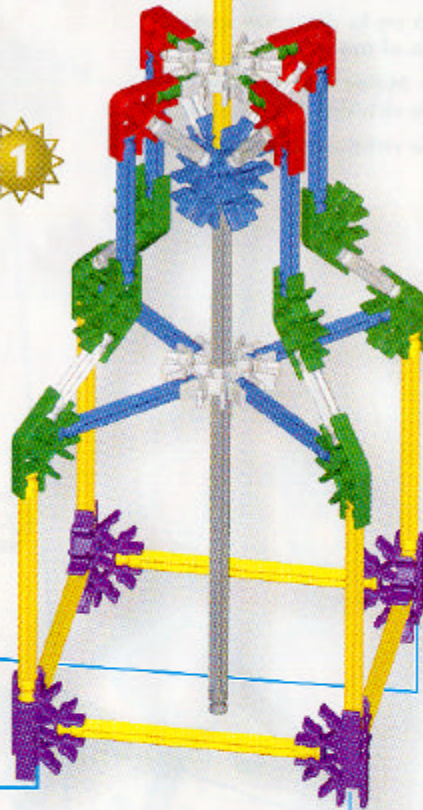

2

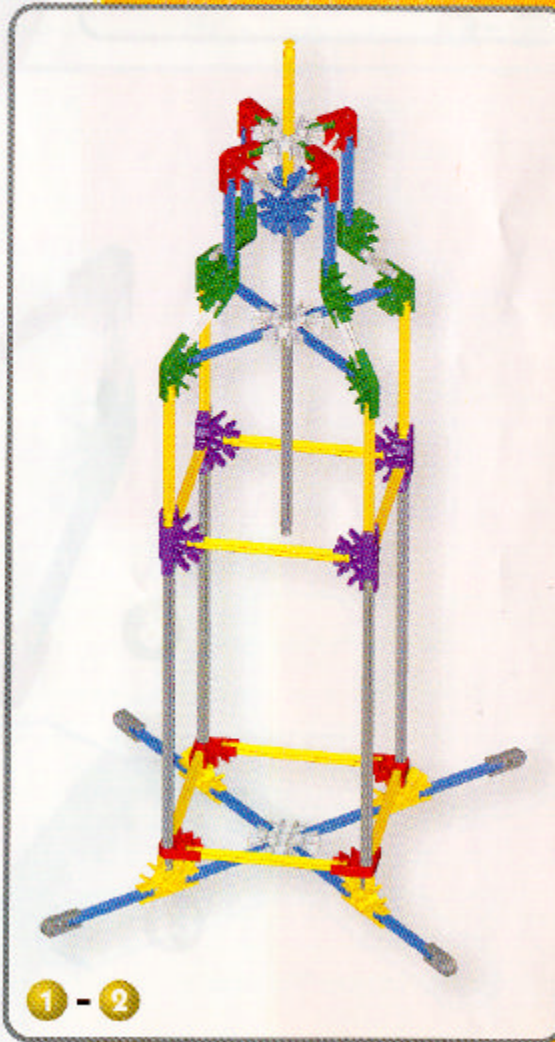
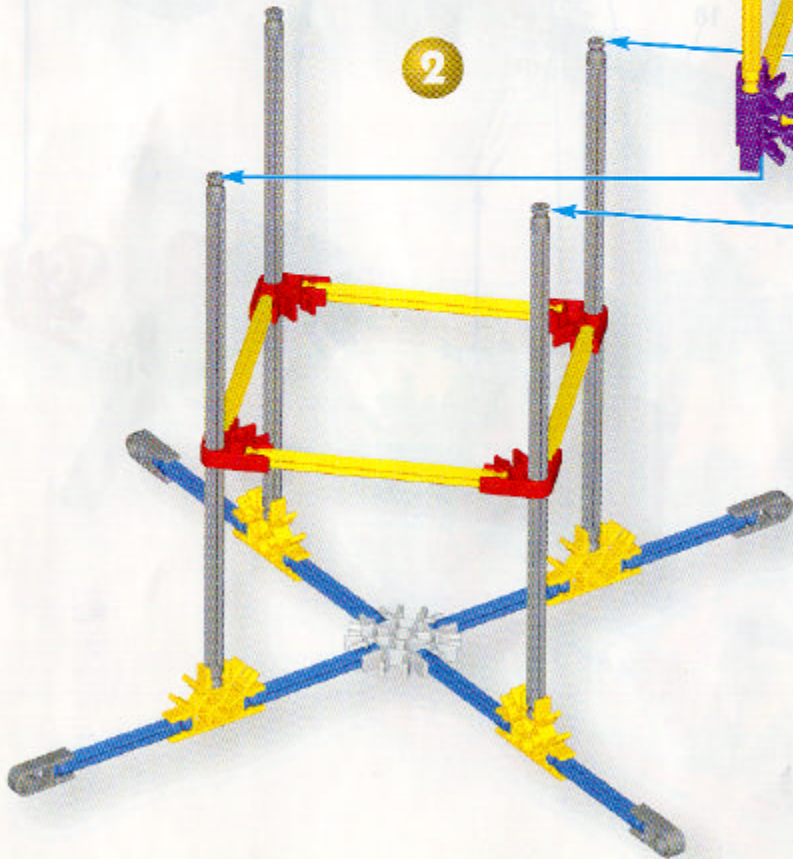

1 - 2

arrow on top of the motor.

- (F) La direction de la voiture correspond à l'orientation de la flèche sur le moteur.
- (E) El auto se moverá en la dirección que indica la flecha en el motor.
- (D) Der Pfeil auf dem Motor deutet die Richtung an, in die sich das Auto bewegt.
- (NL) De auto rijdt in de richting van de pijl op de motor.

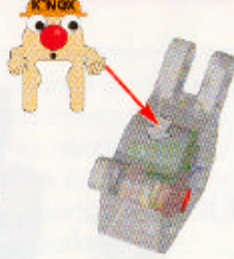

3 - 6

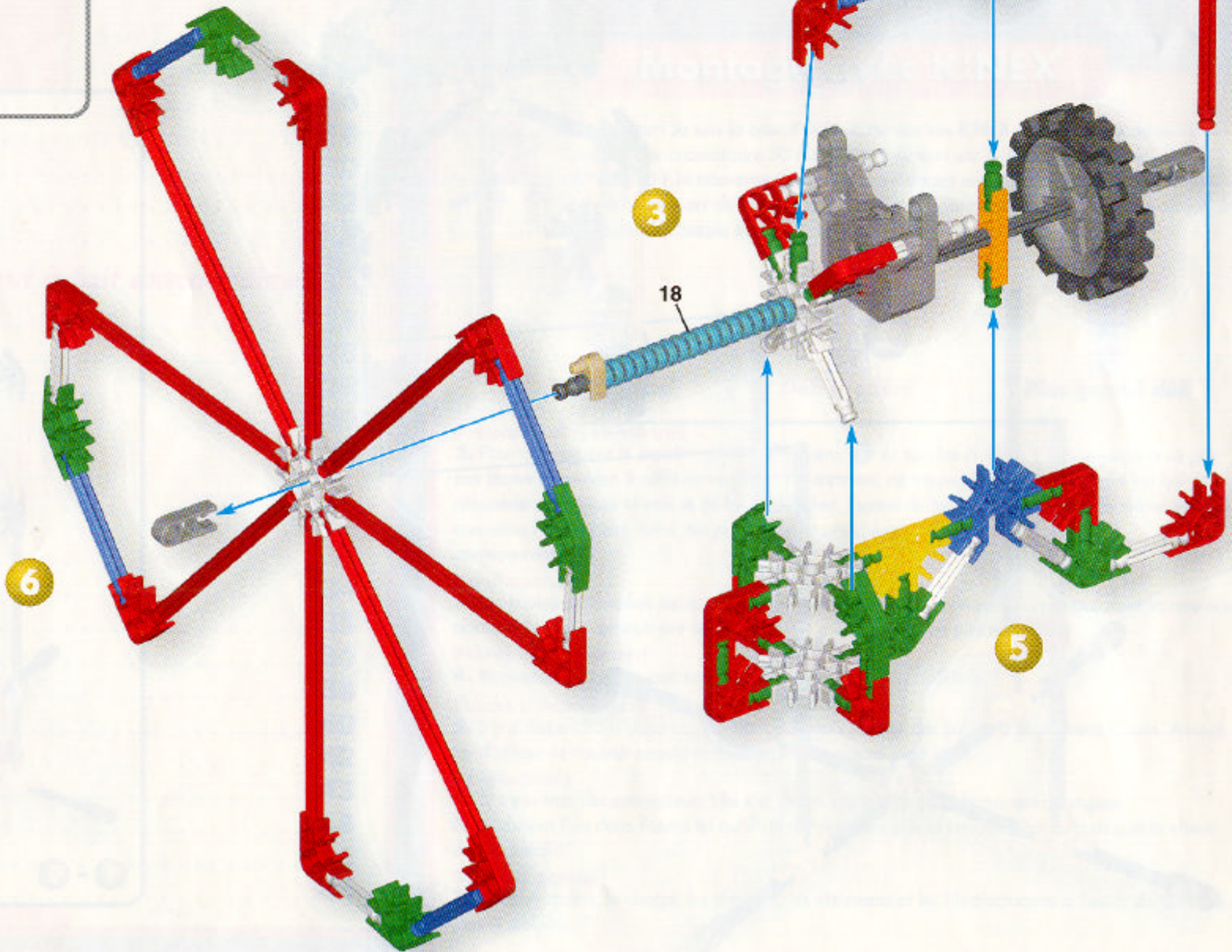

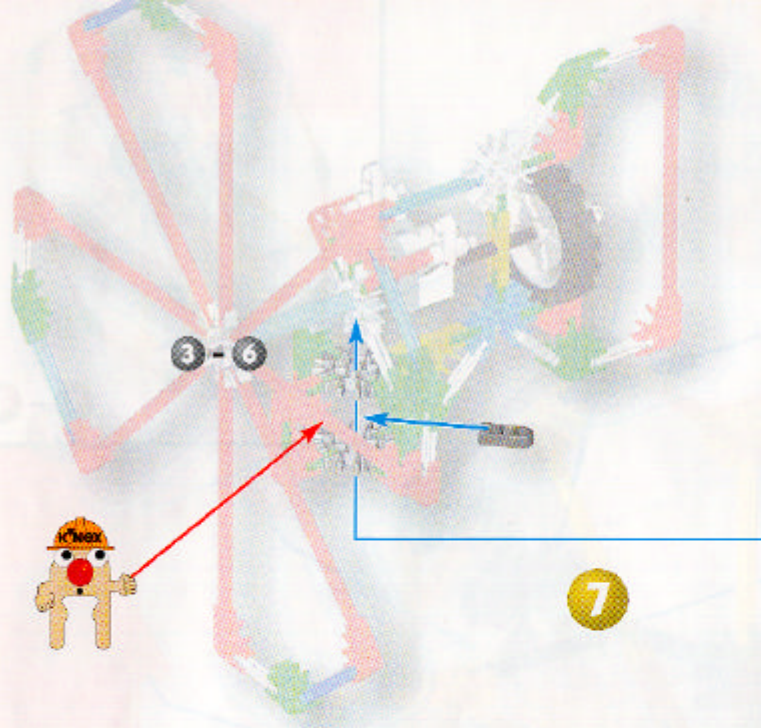

7

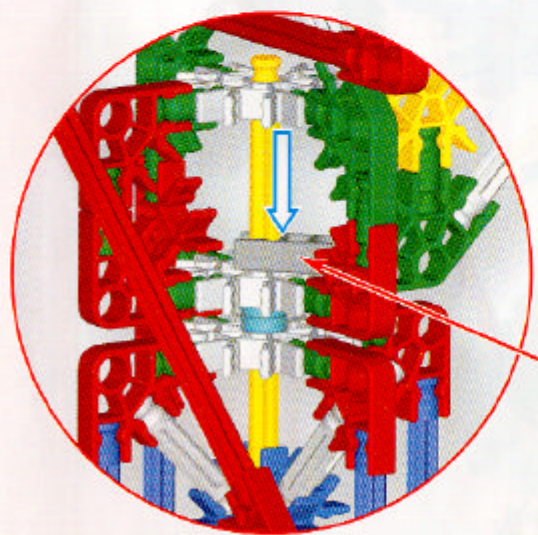

1 - 2

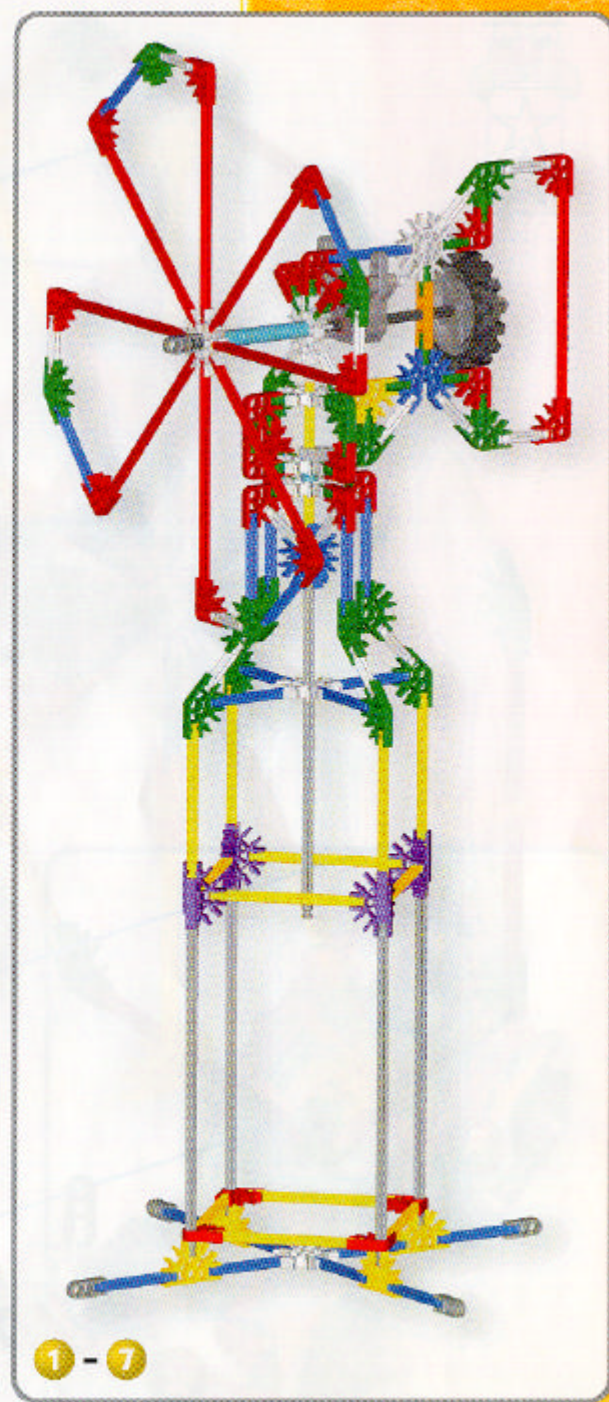

1 - 7

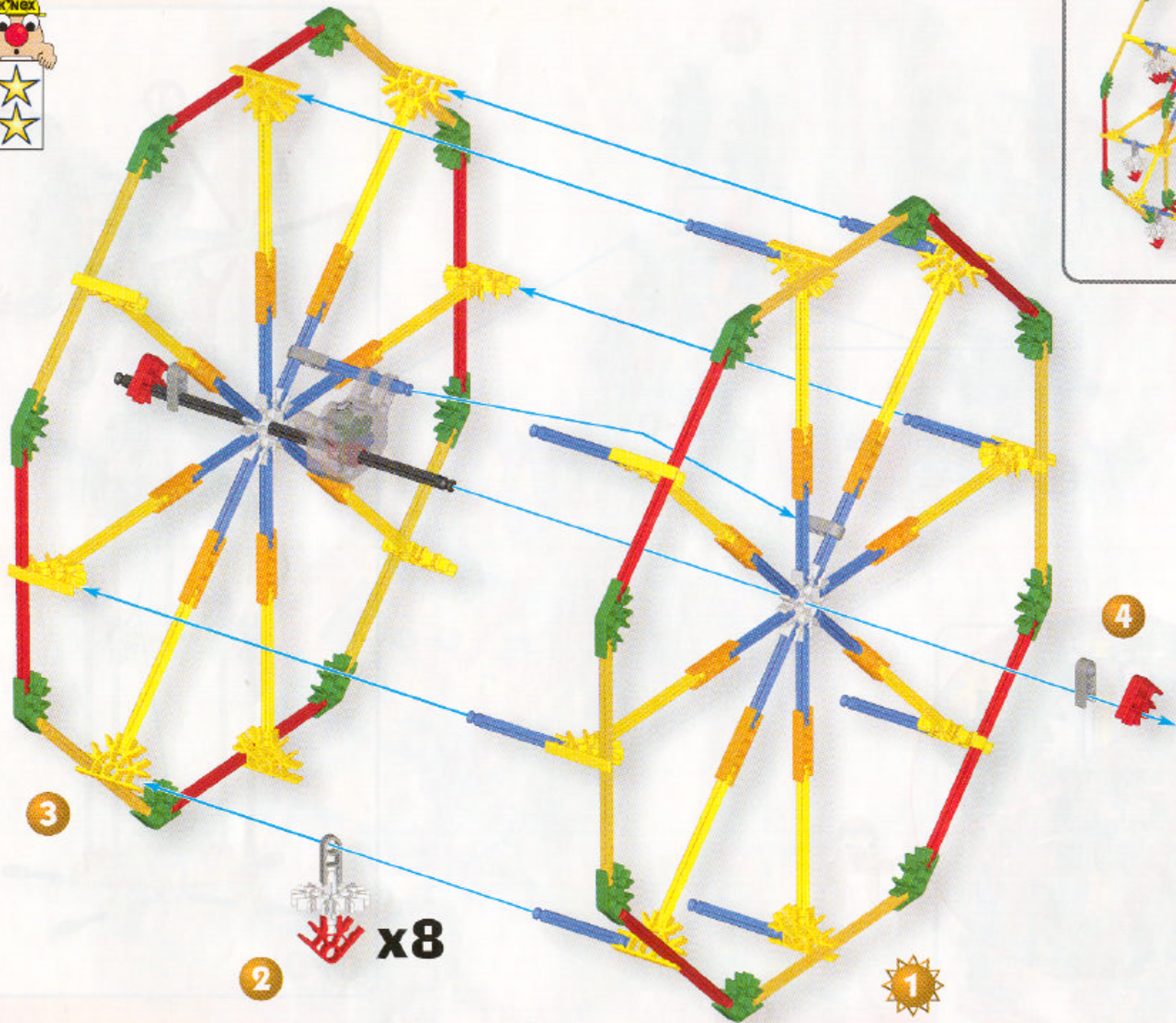

2  x8

1 

3

4

1 - 4

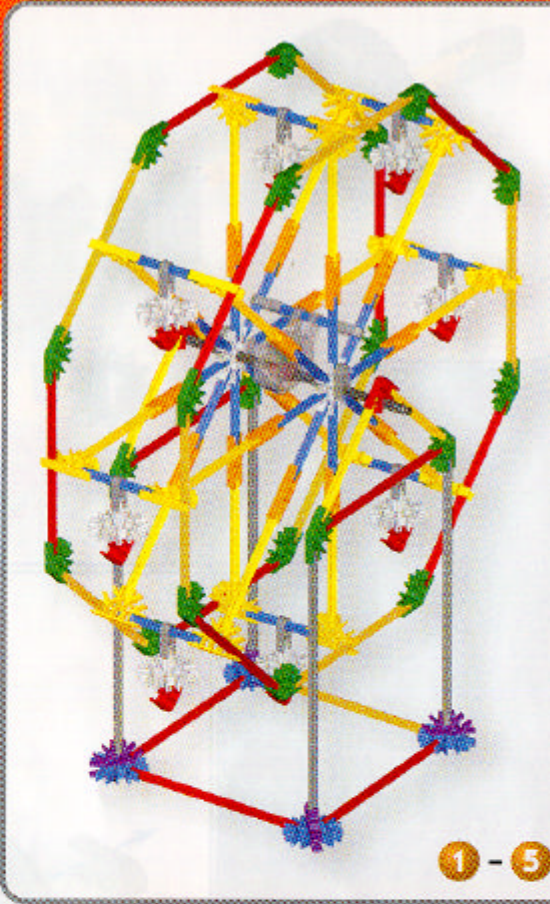
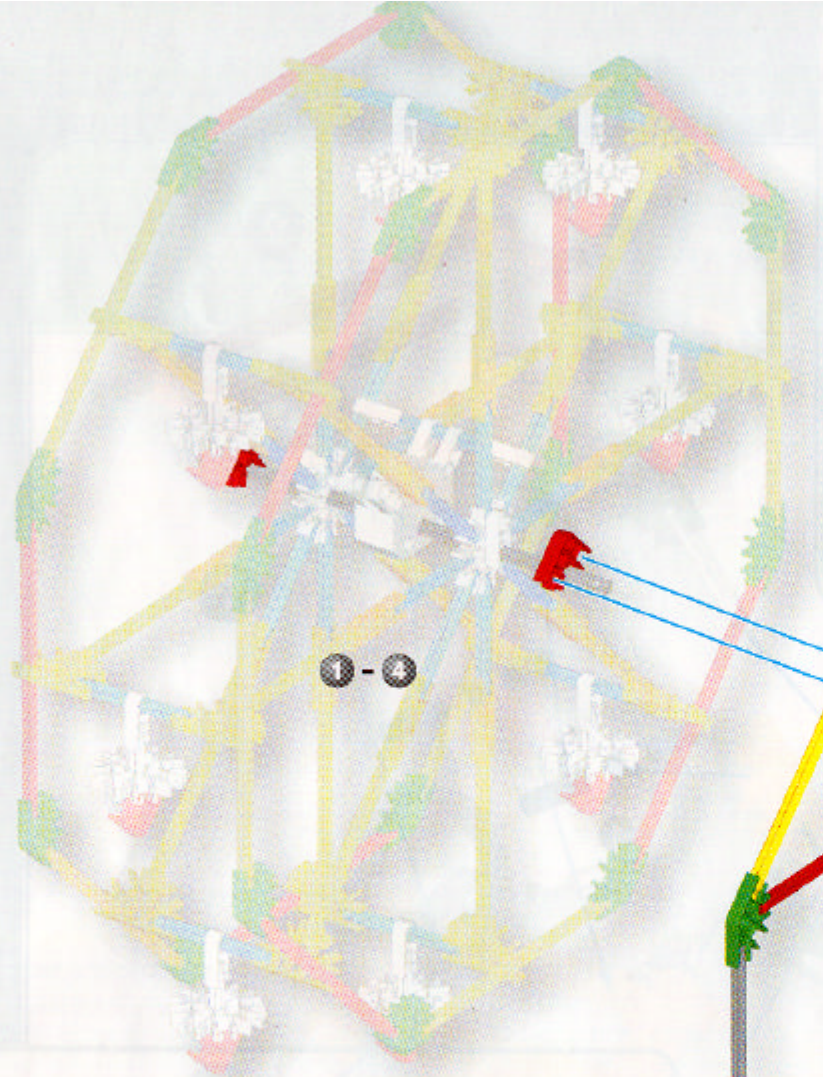

5

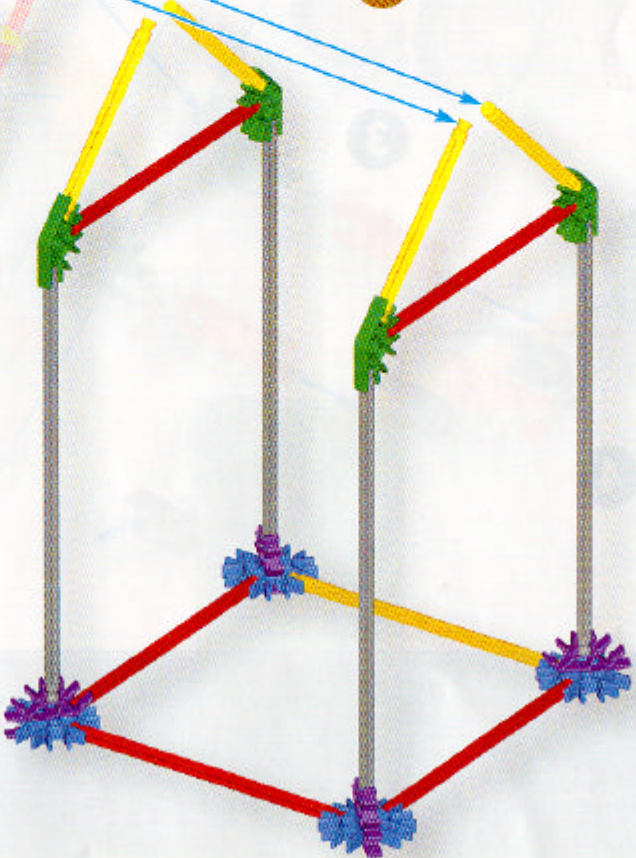

1-5



1

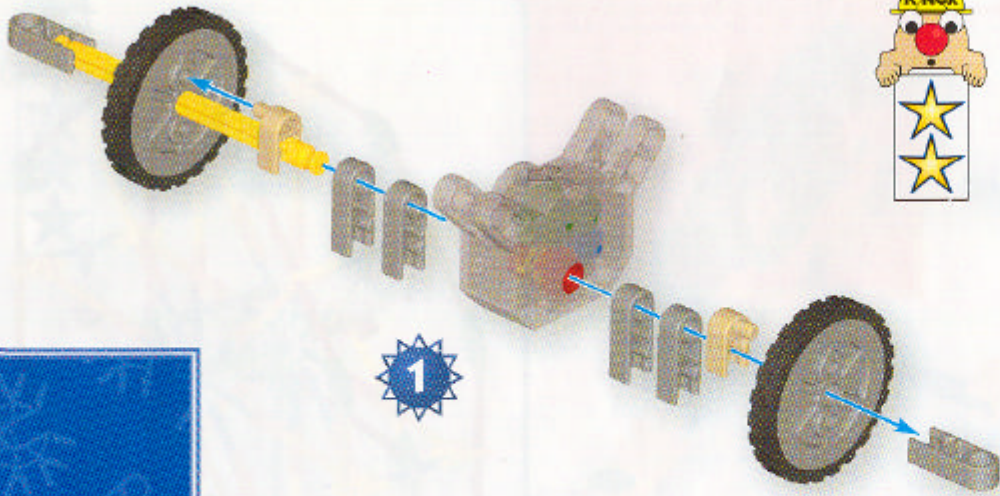

2

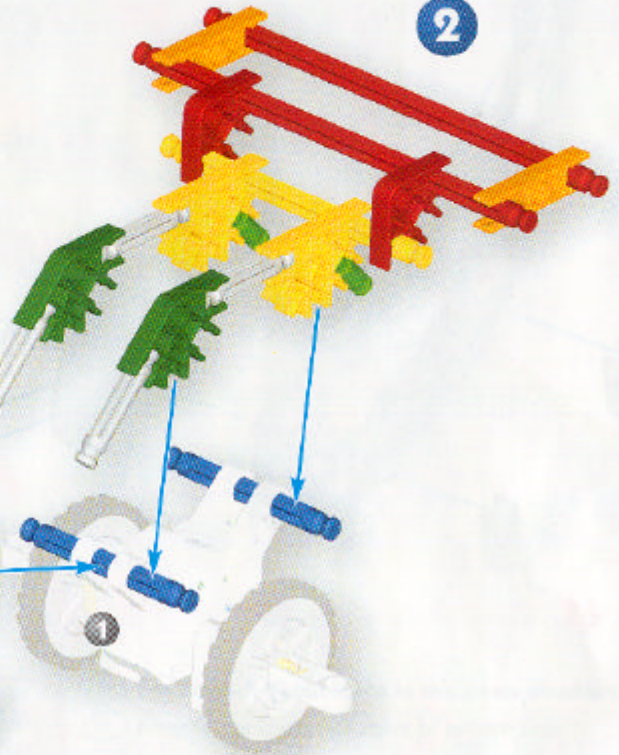

3

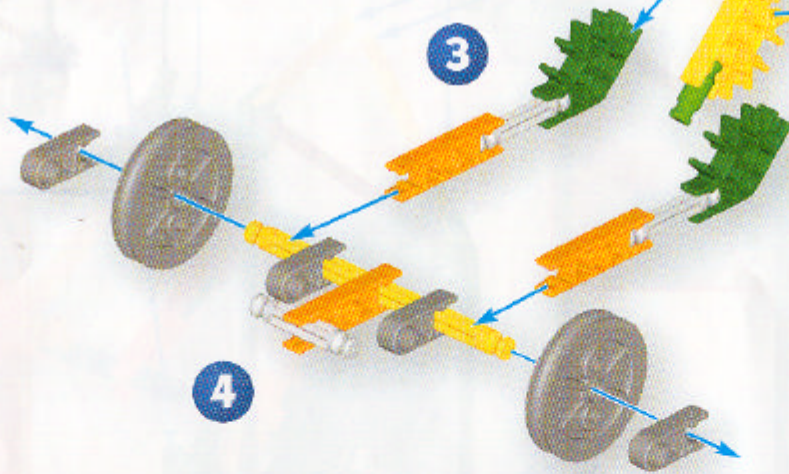

4

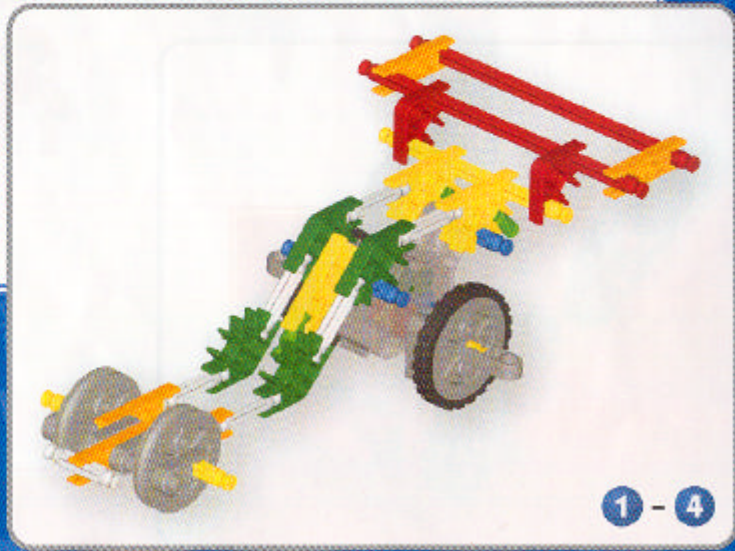

1 - 4

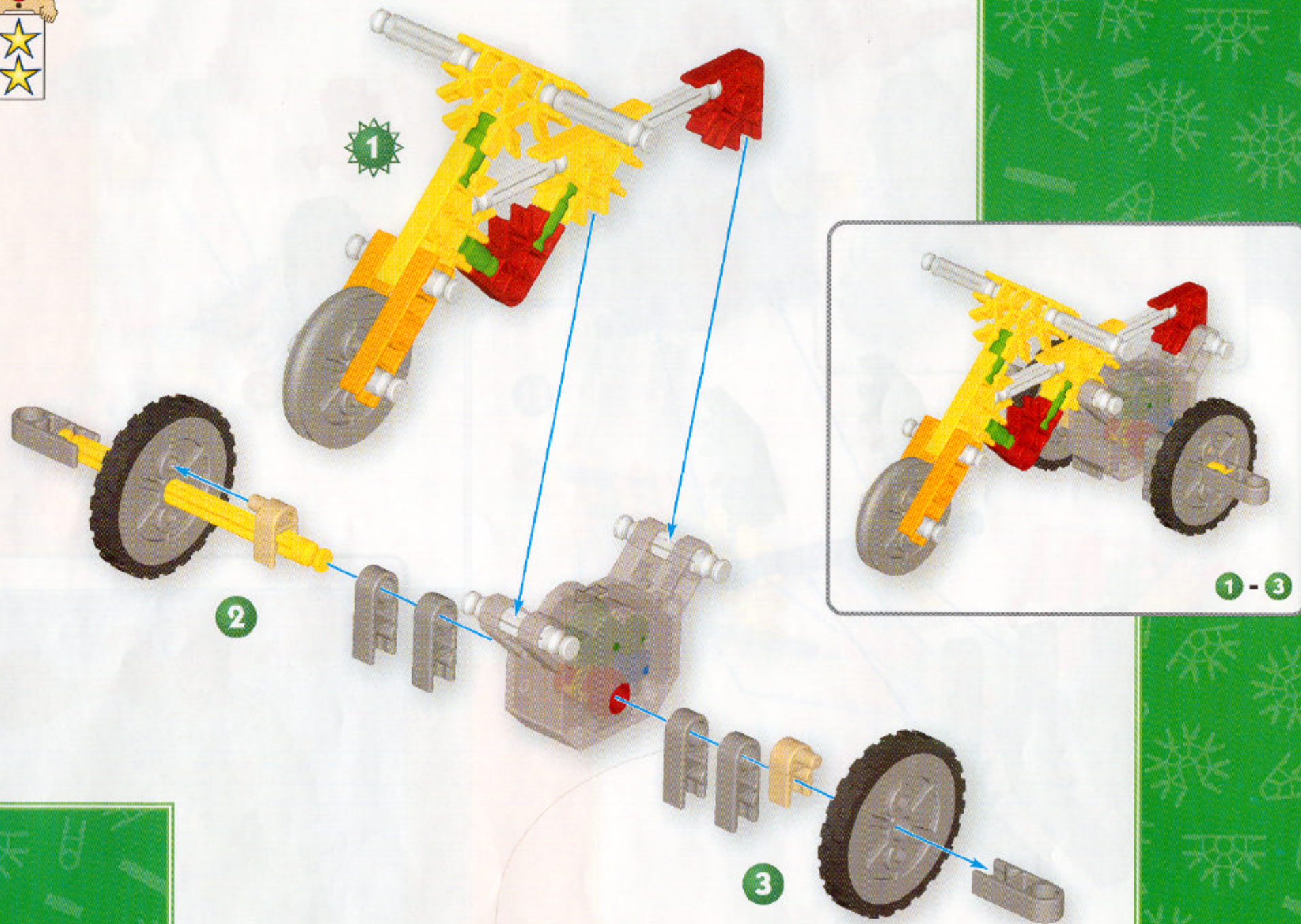

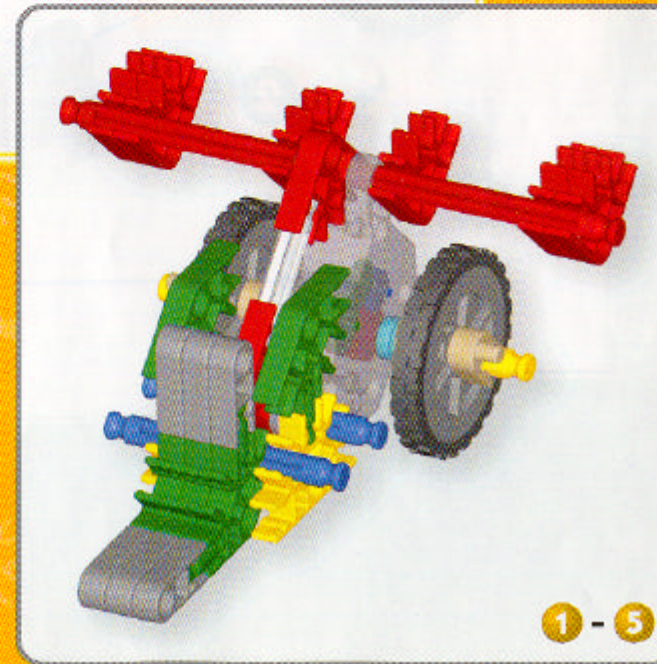
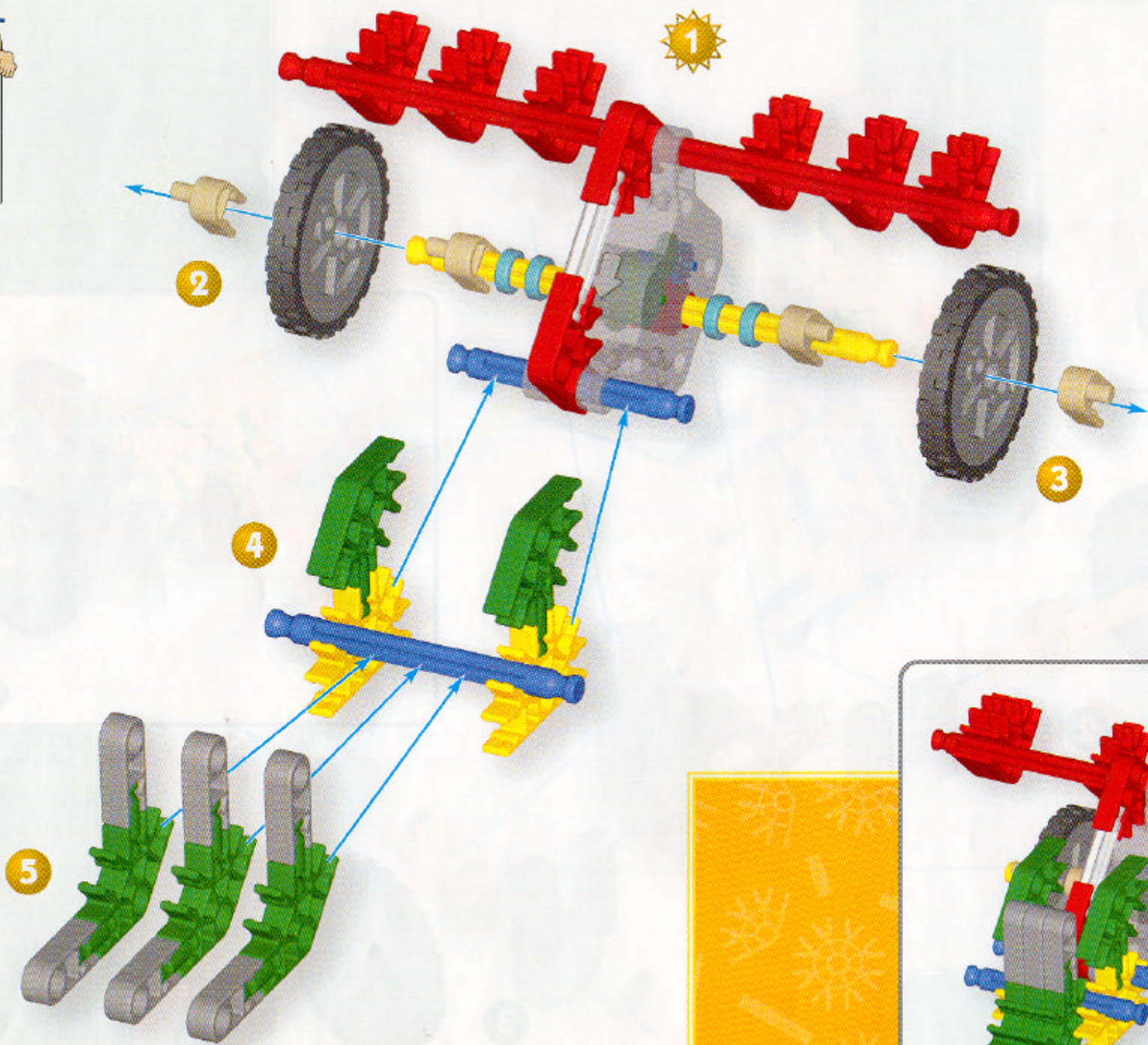

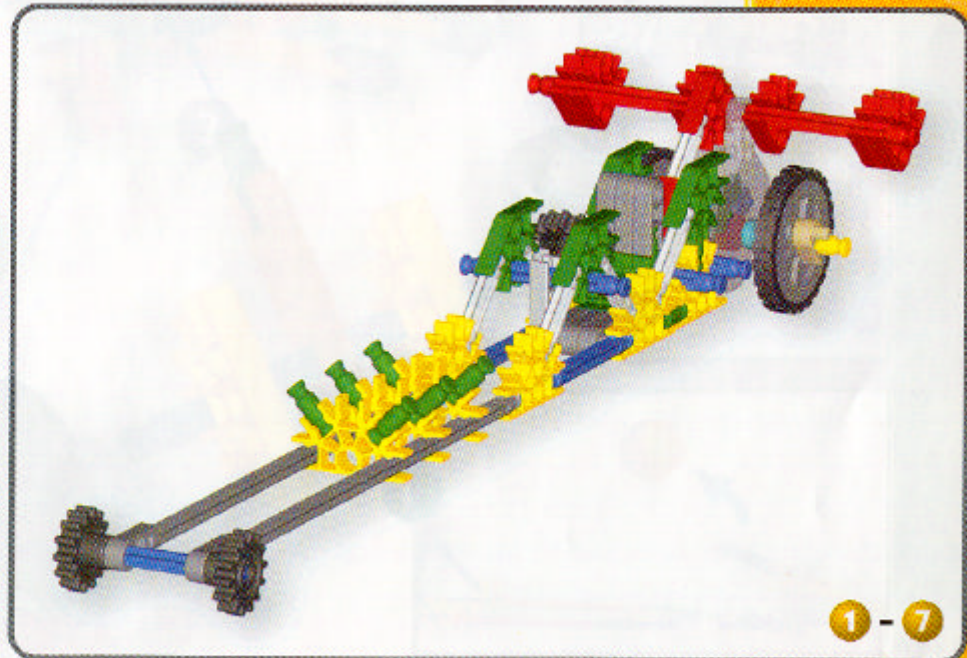
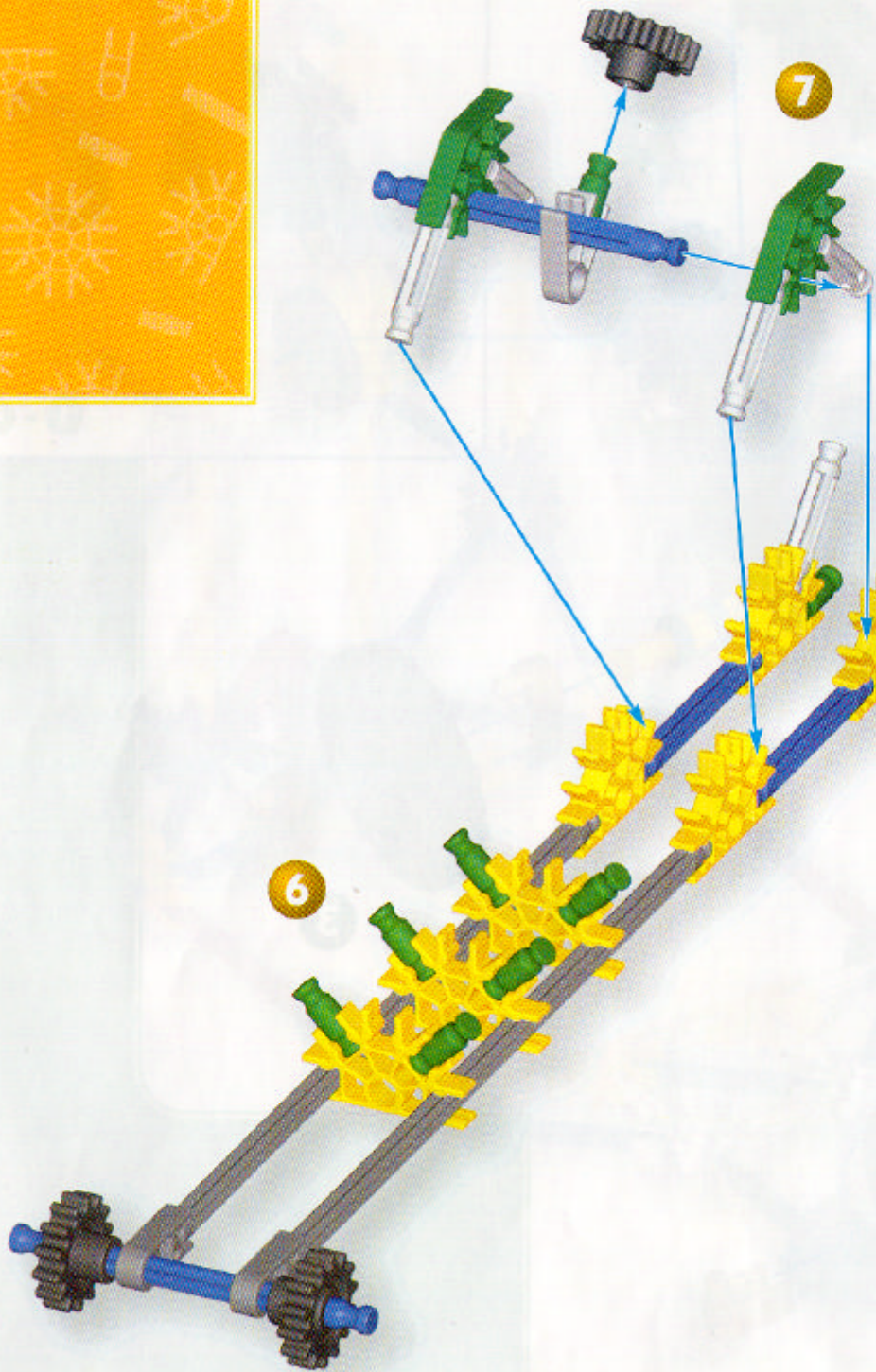

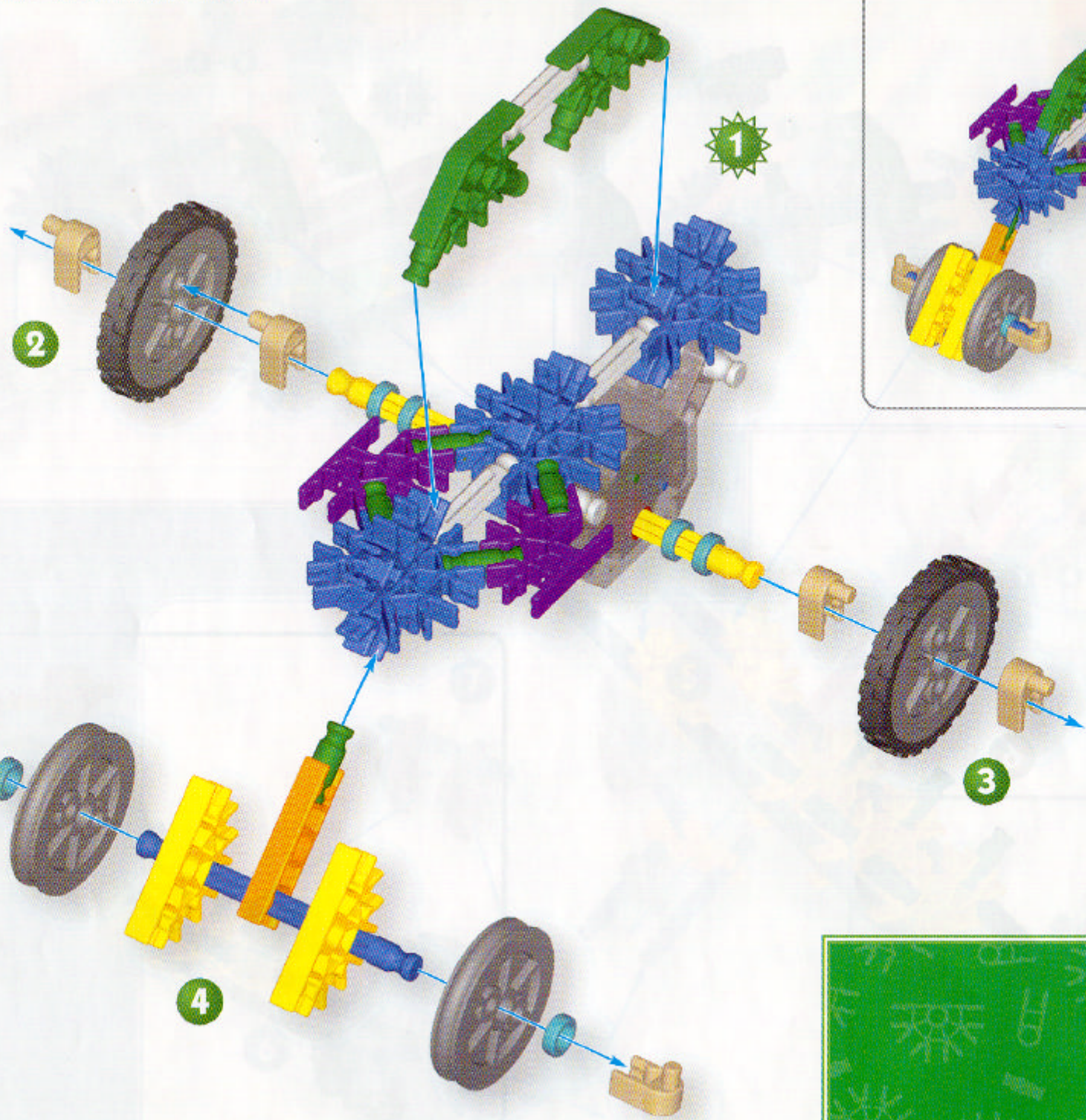

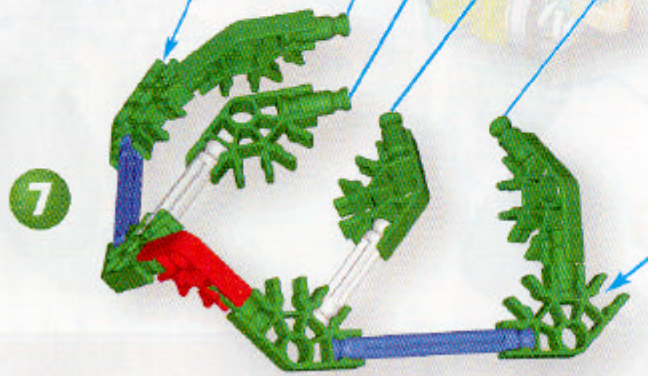
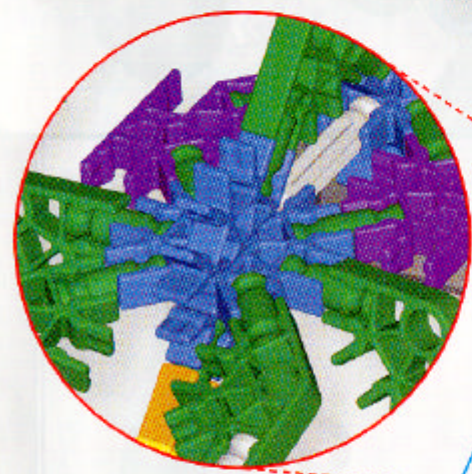
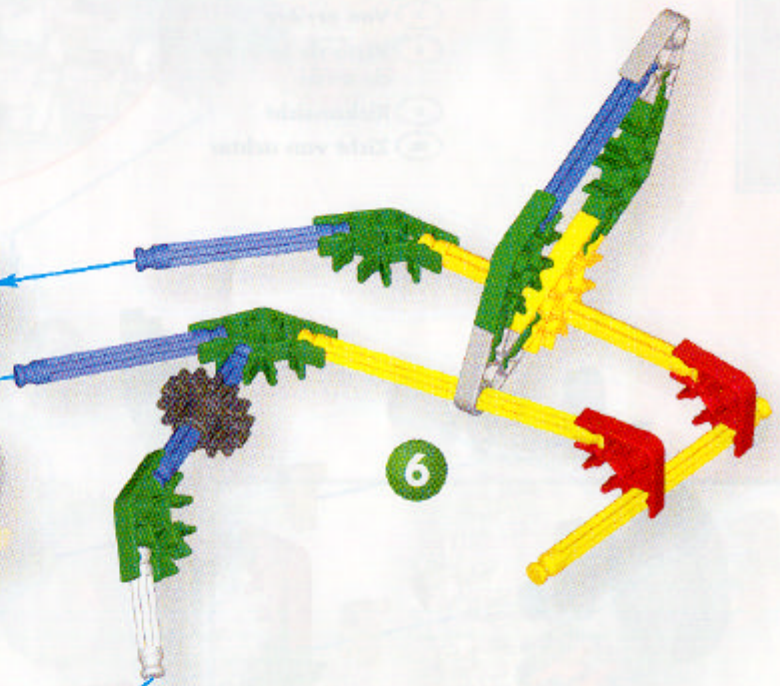
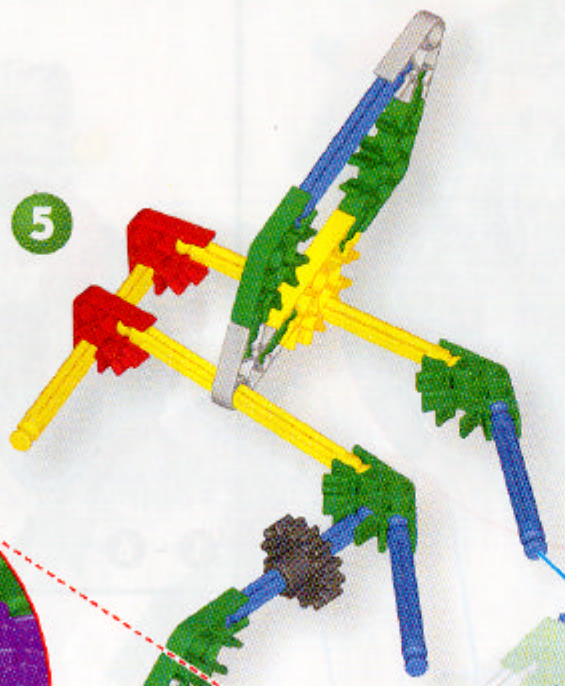

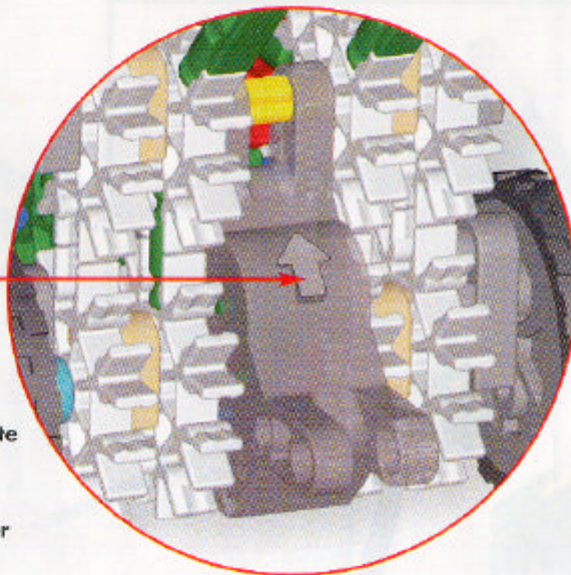

- US (G) Back view
- F (F) Vue arrière
- E (E) Vista de la parte de atrás
- D (D) Rickansicht
- NL (NL) Zicht van achter

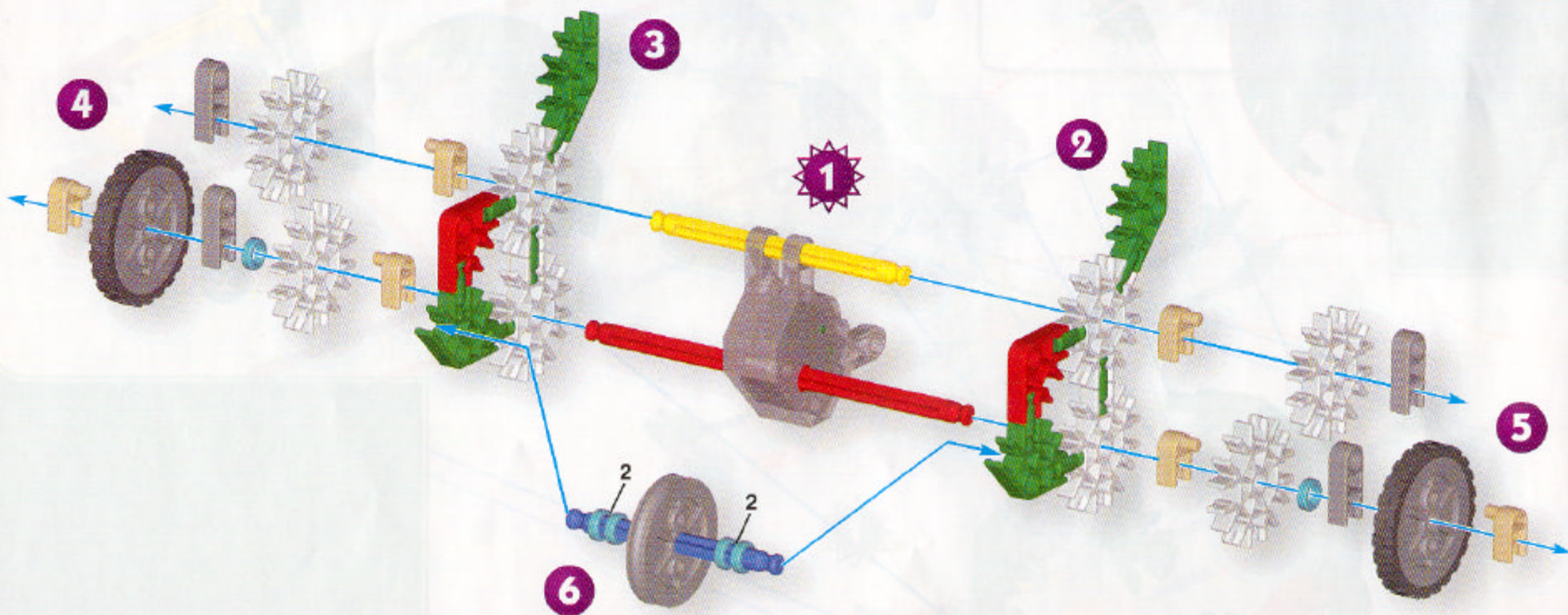
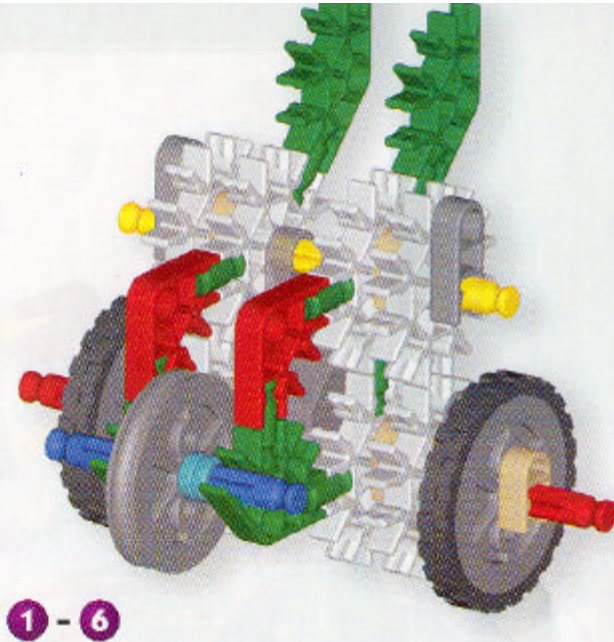

9

8

7

6

1 - 6

1 - 9

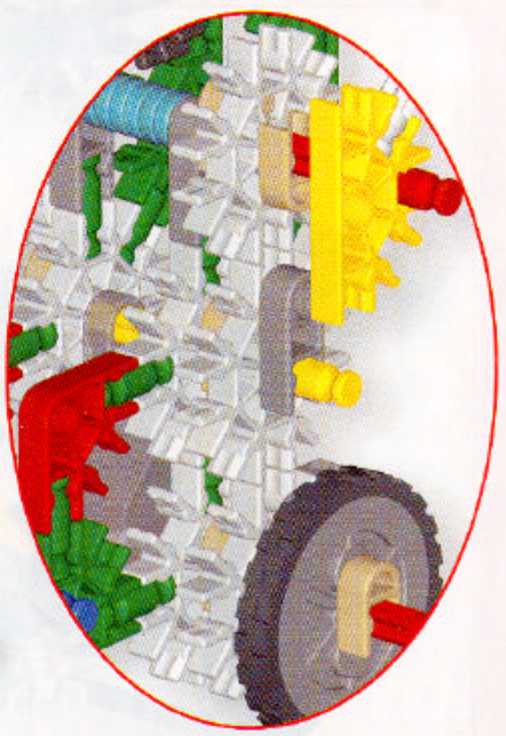
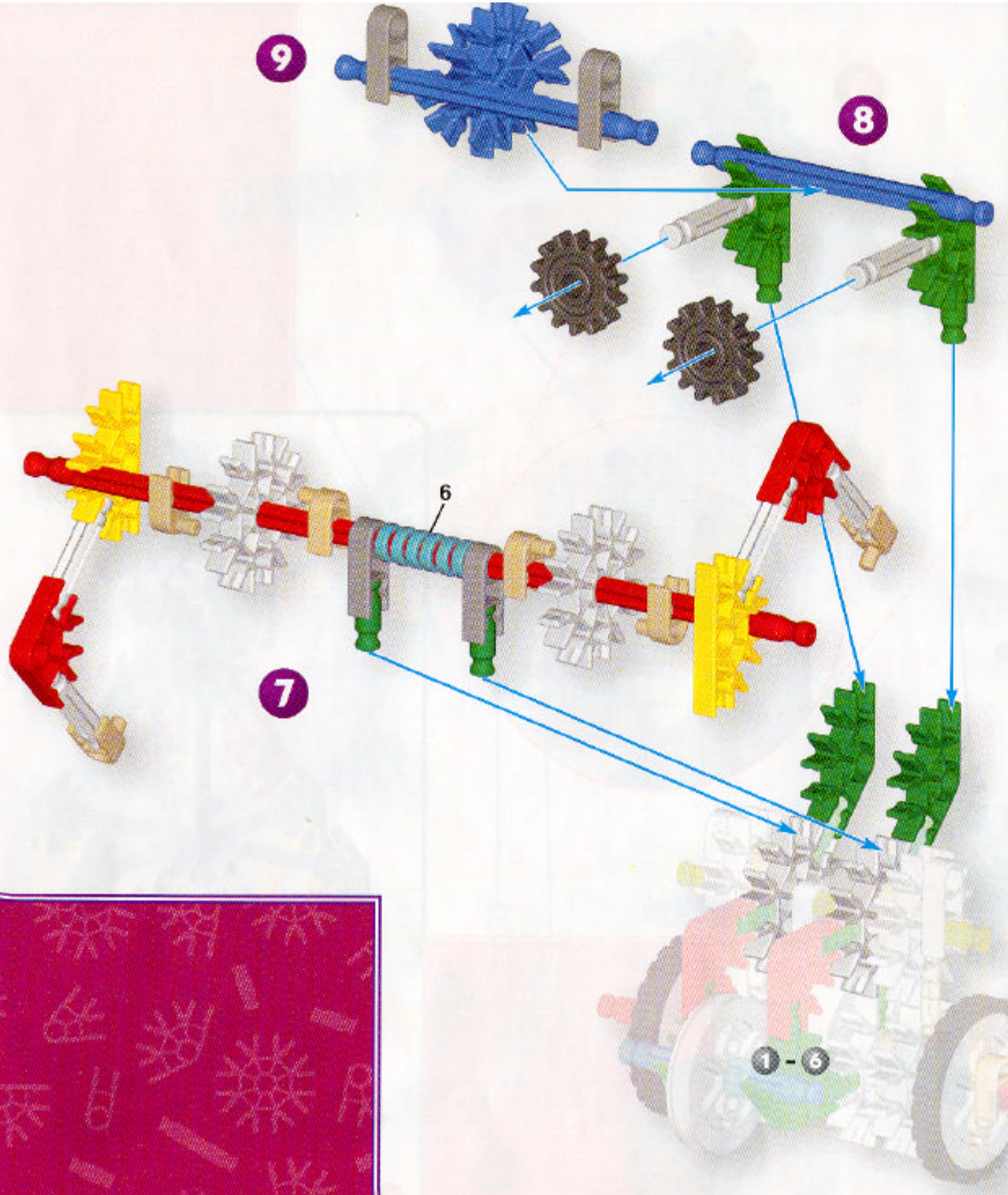



1

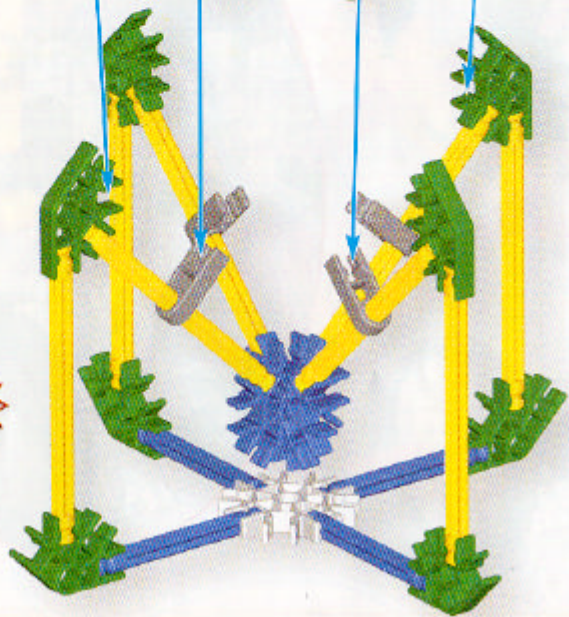

2

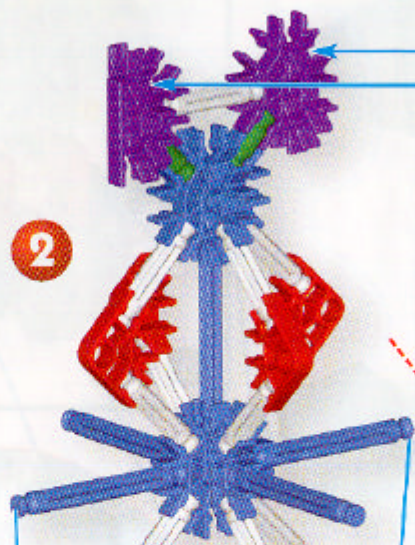

3



1 - 3



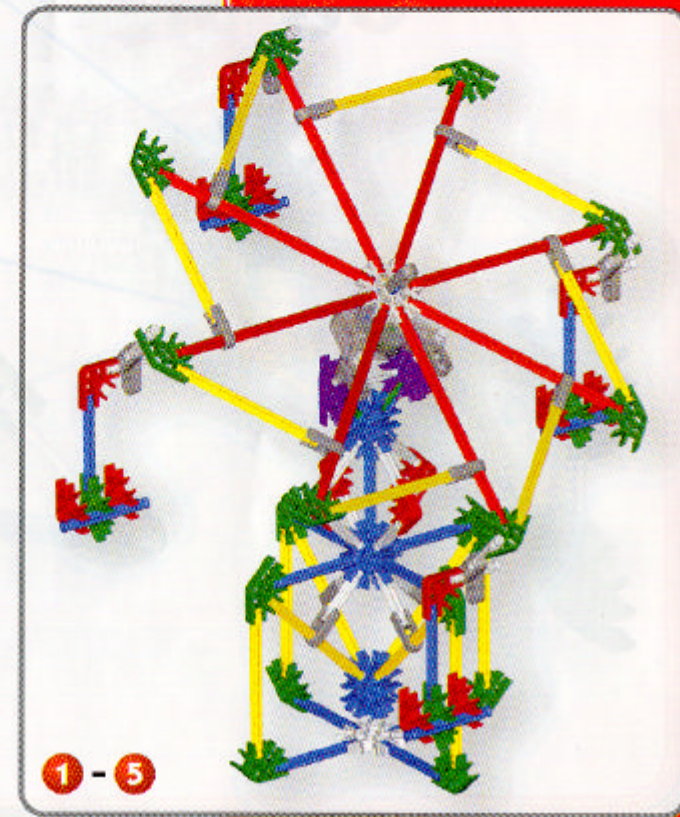
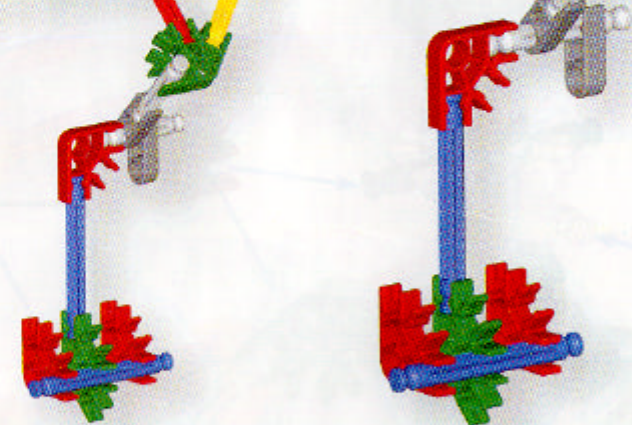
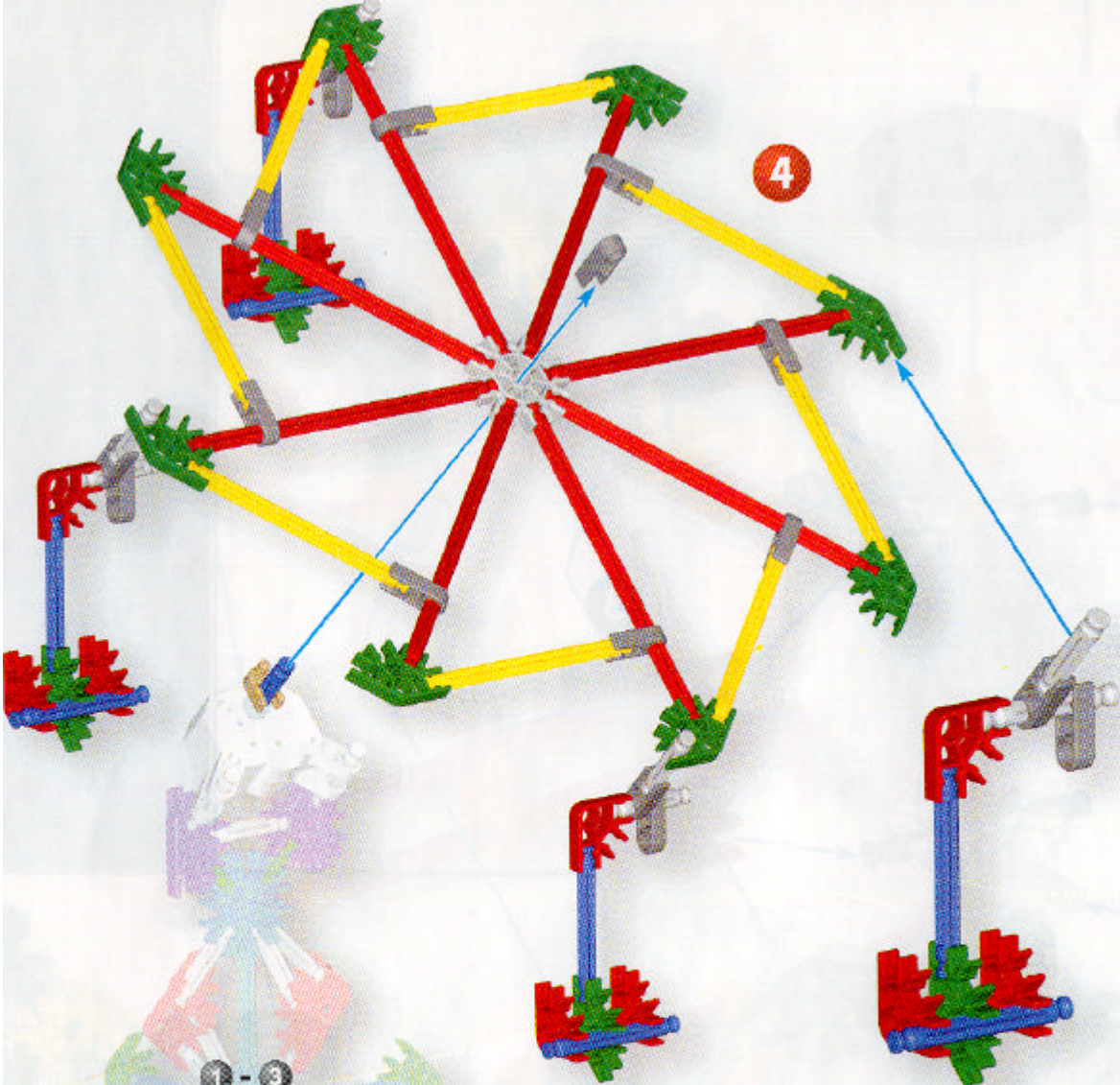

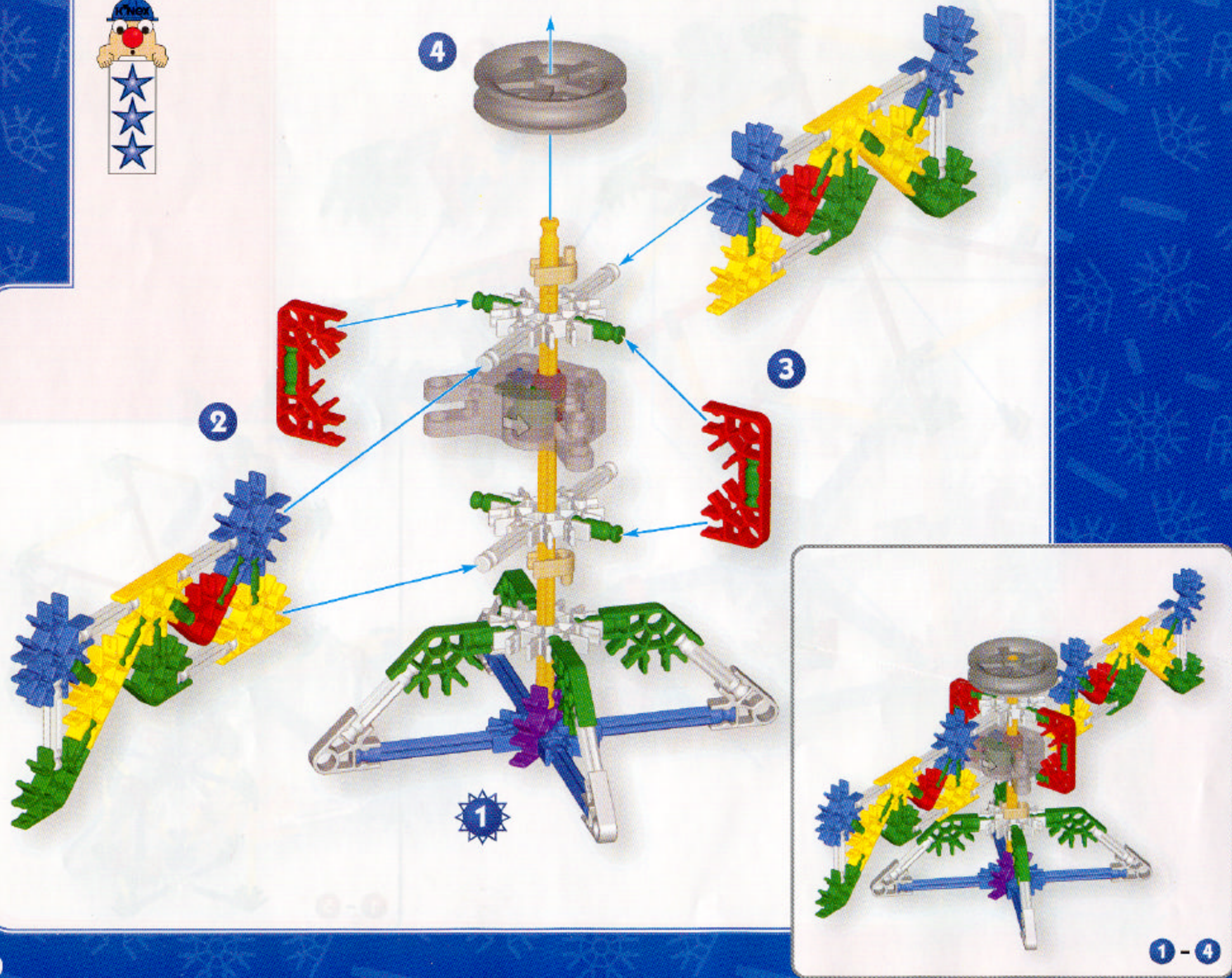

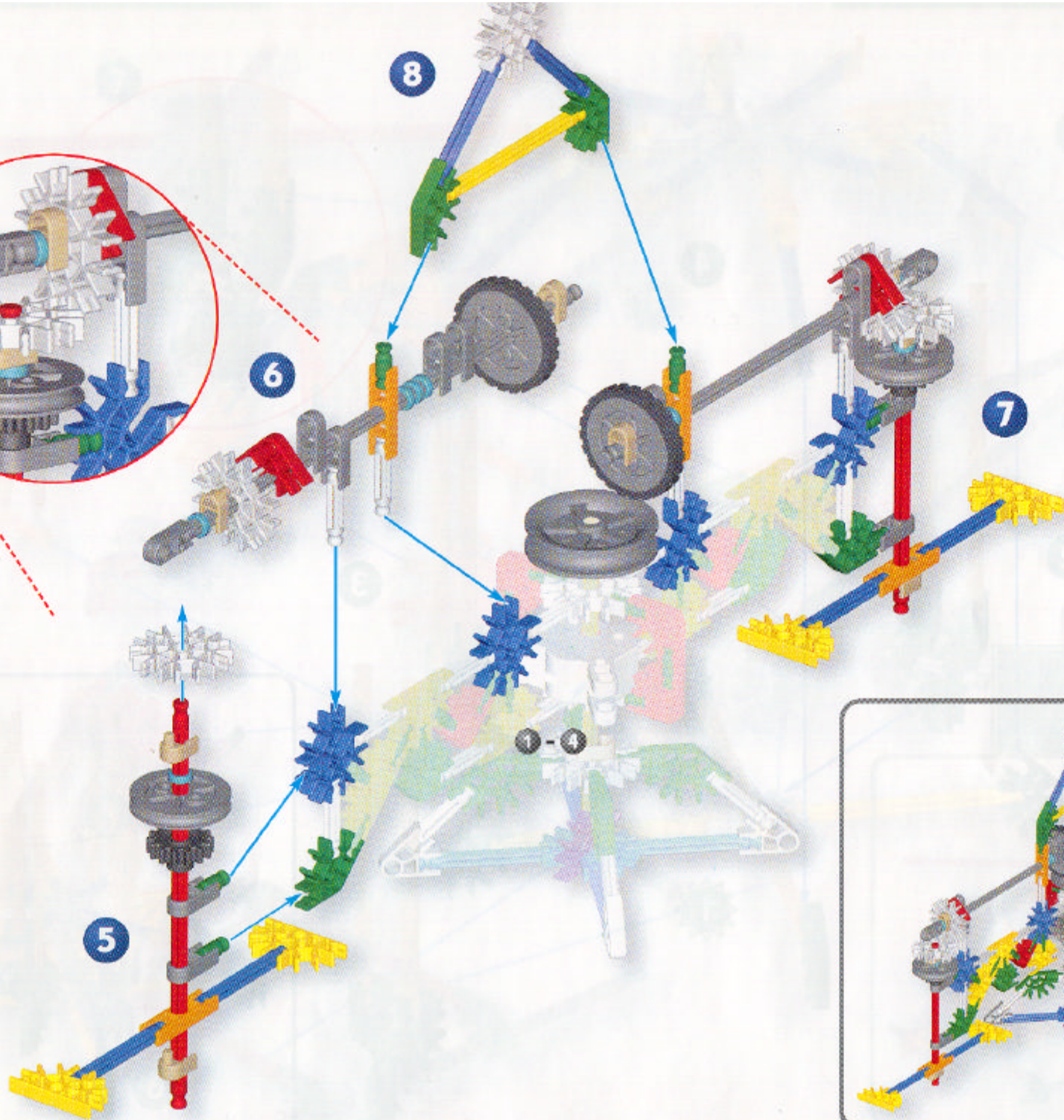
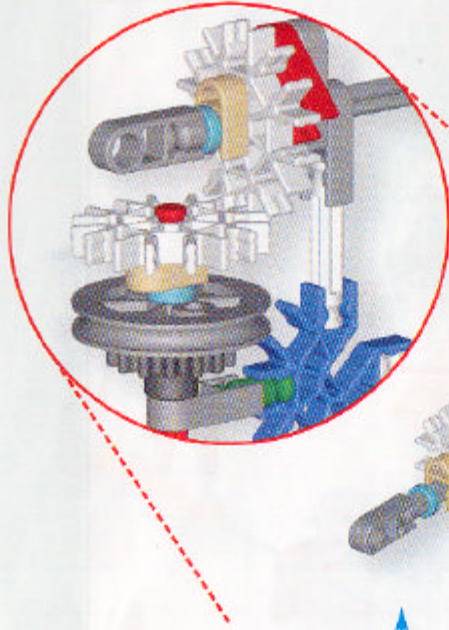

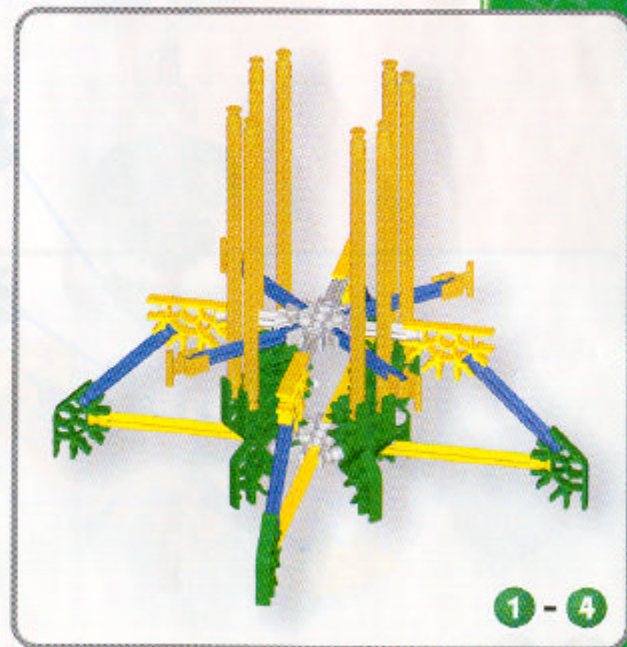
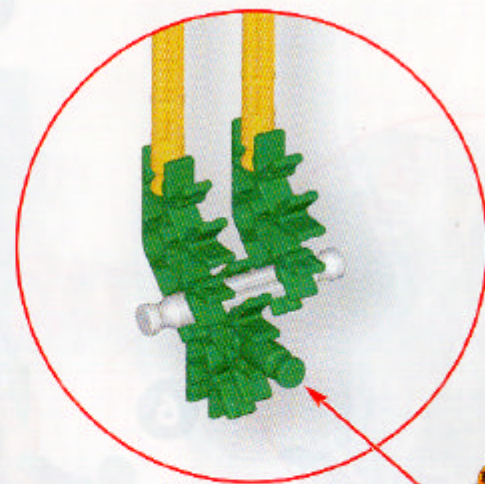
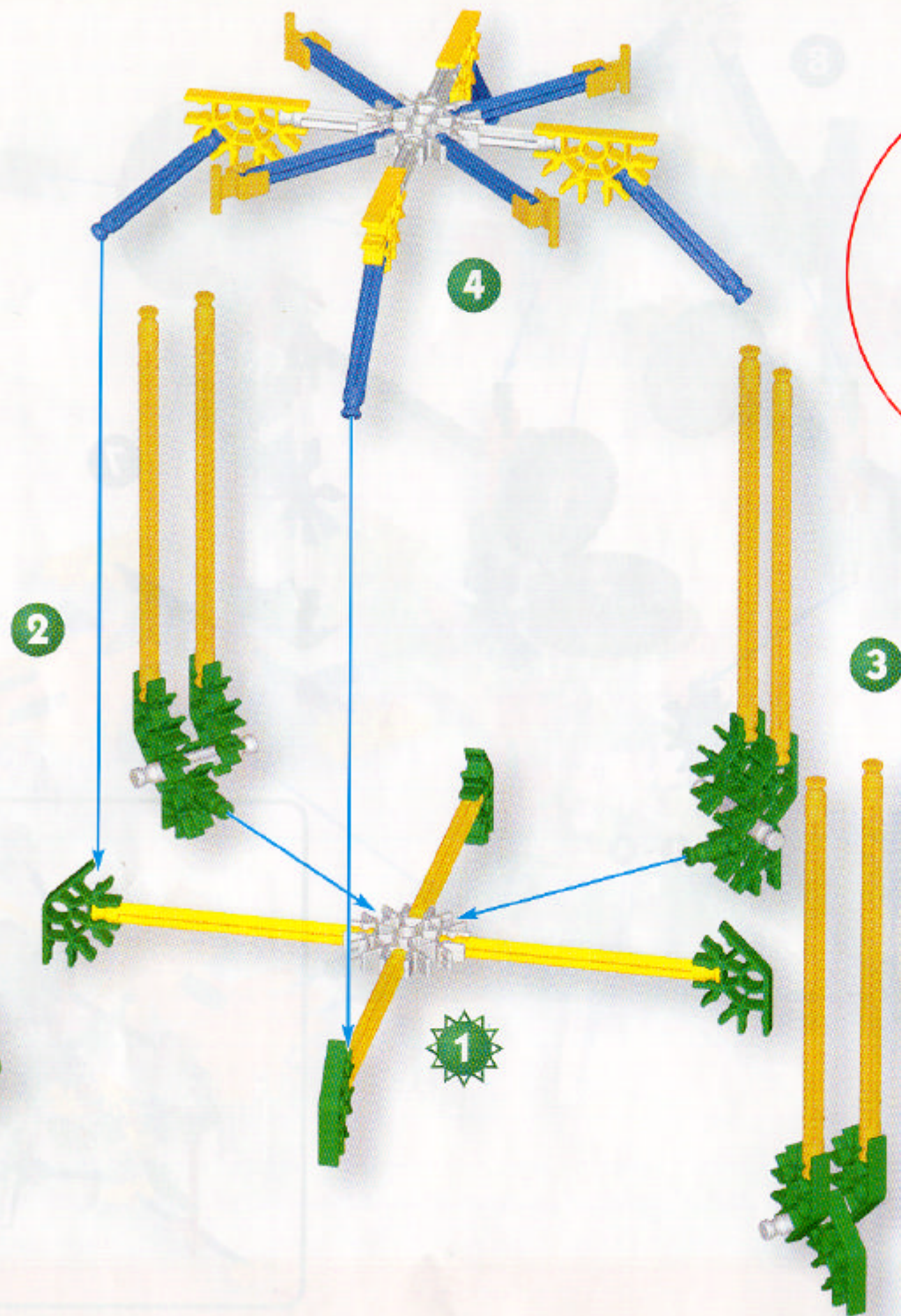

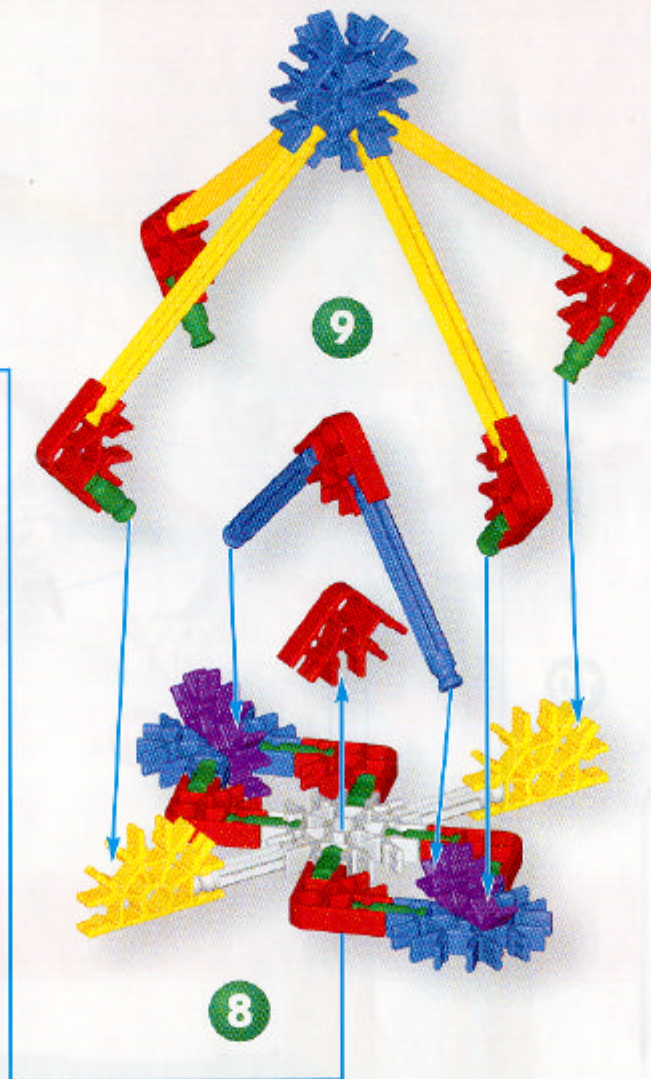
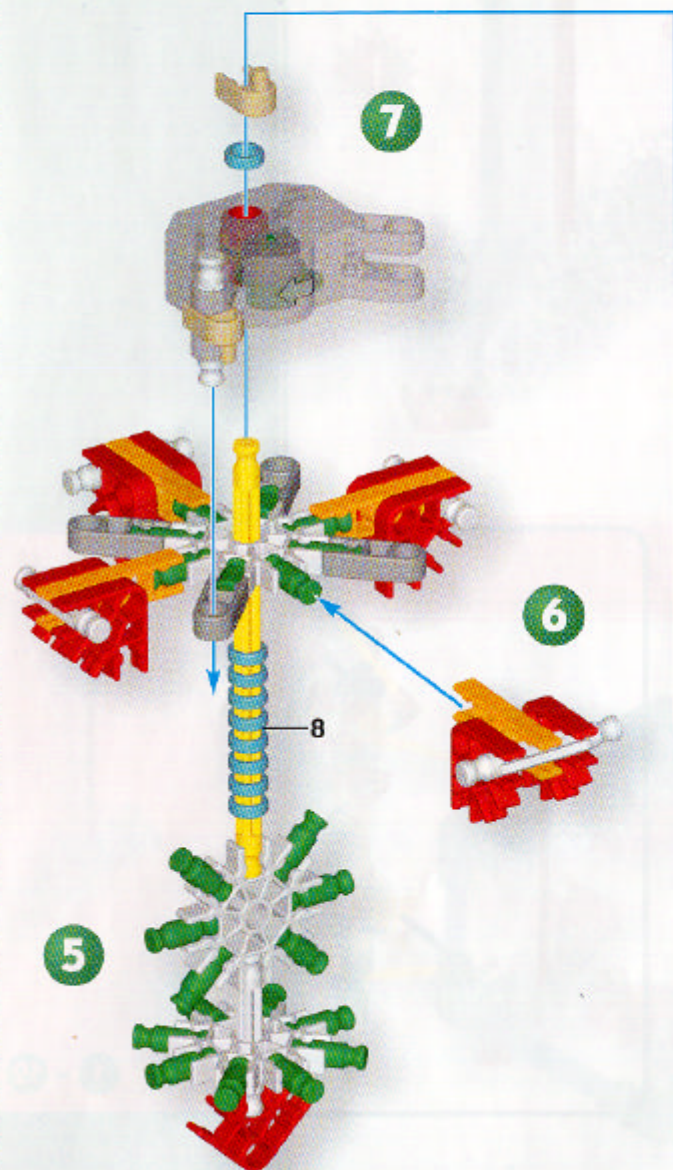

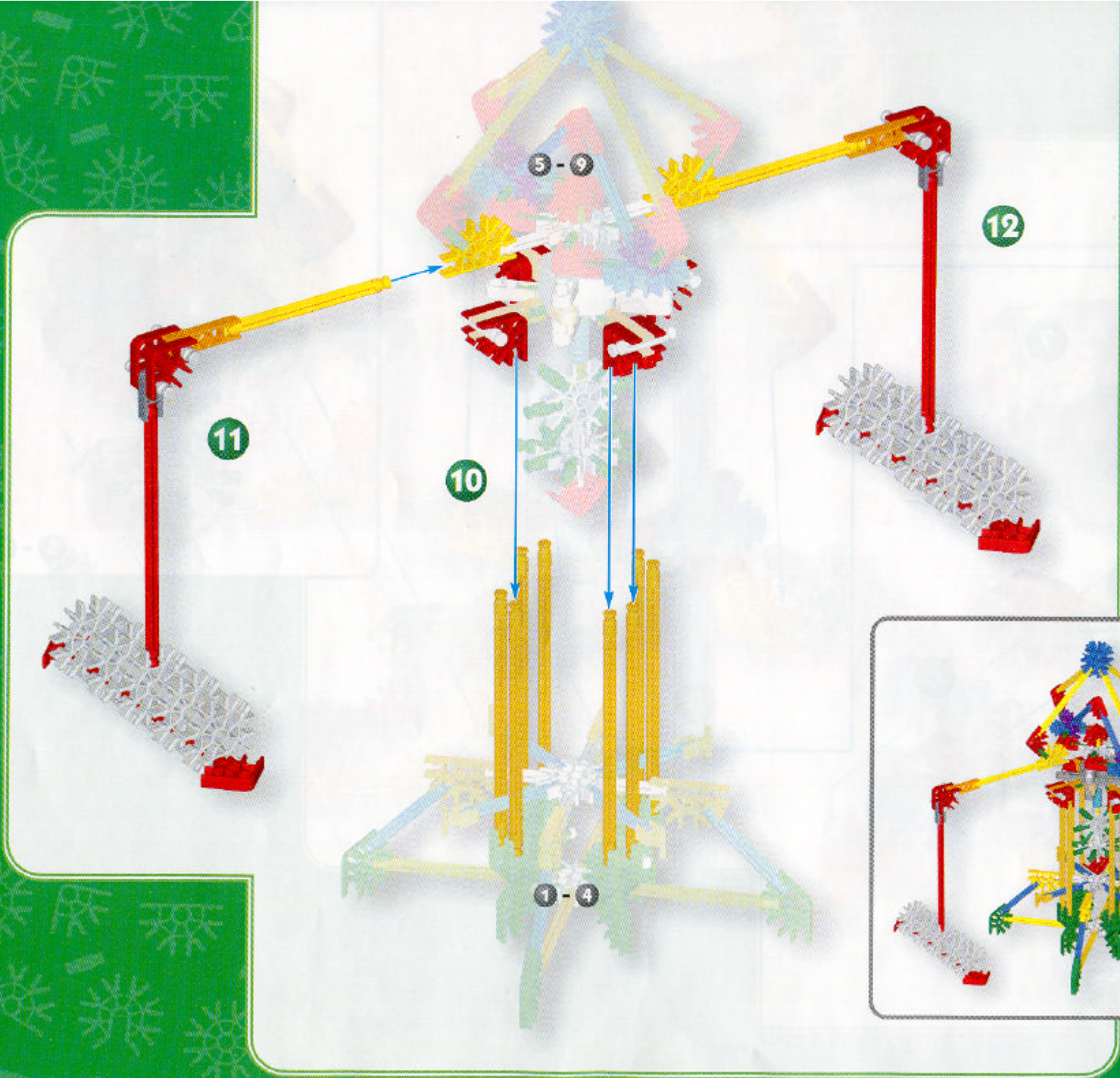

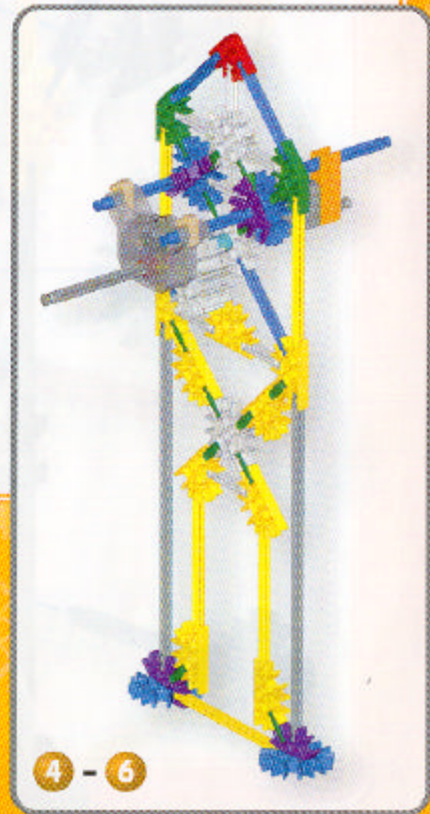
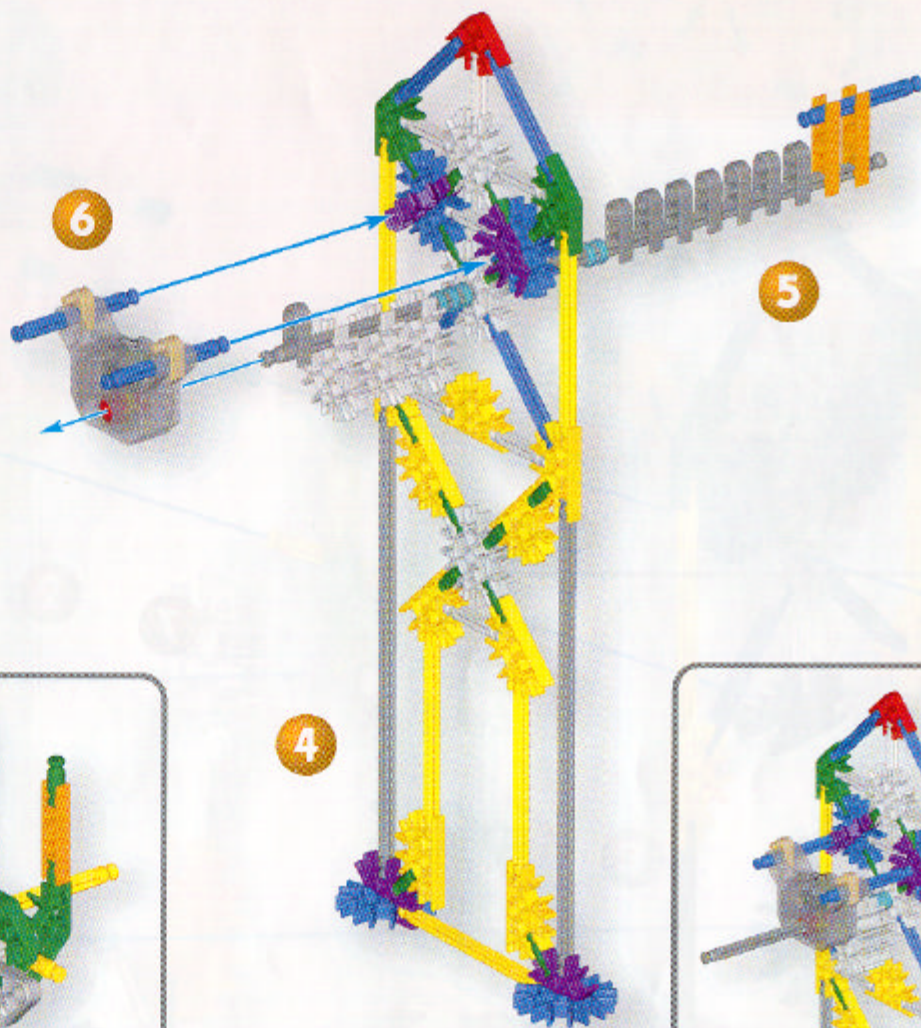
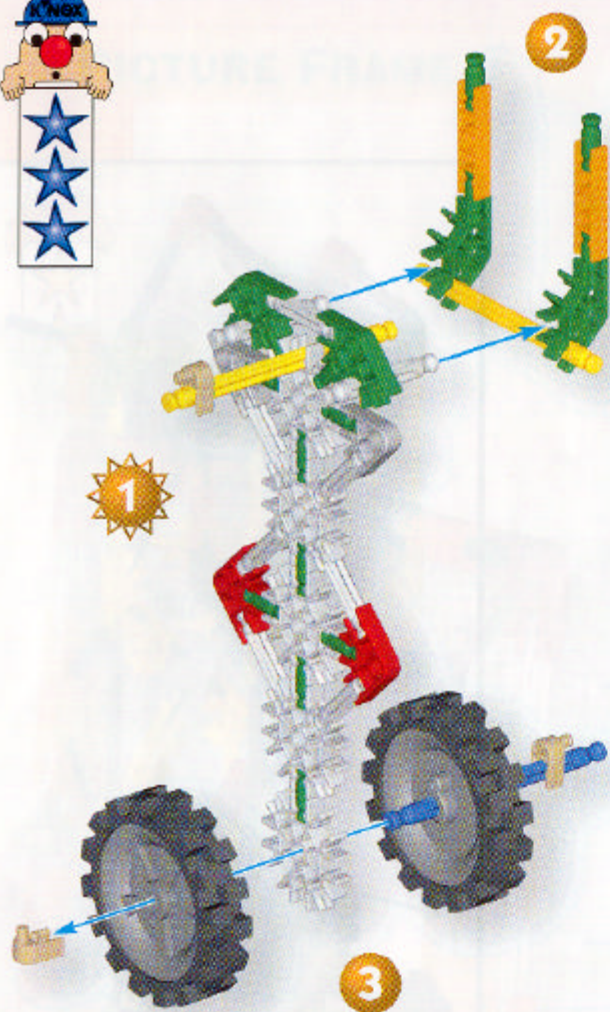

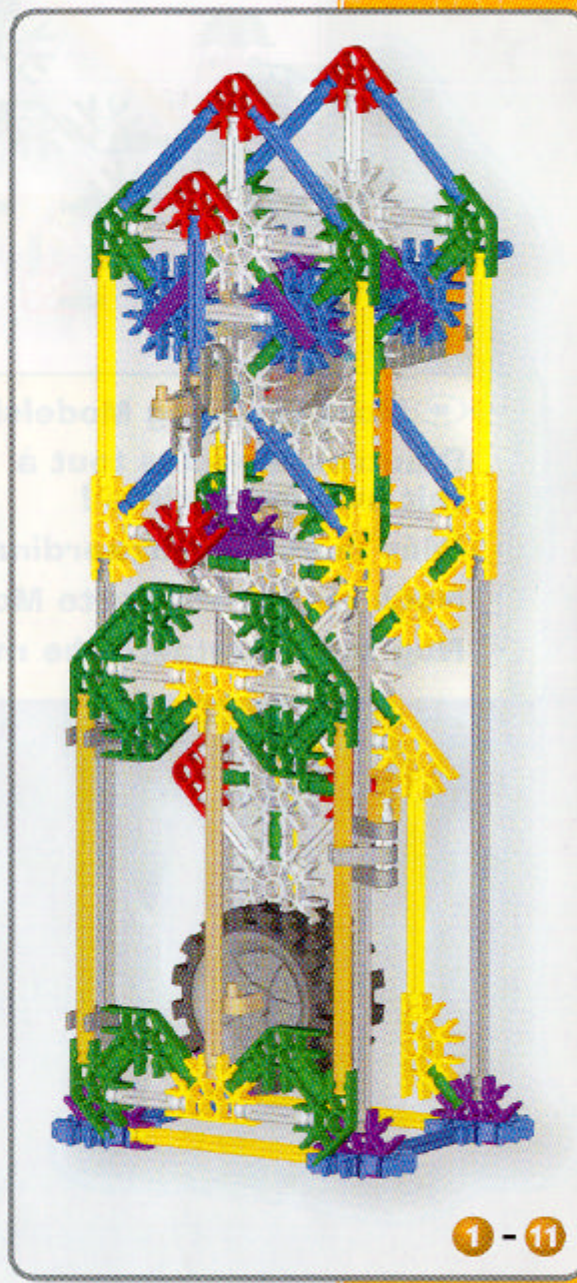
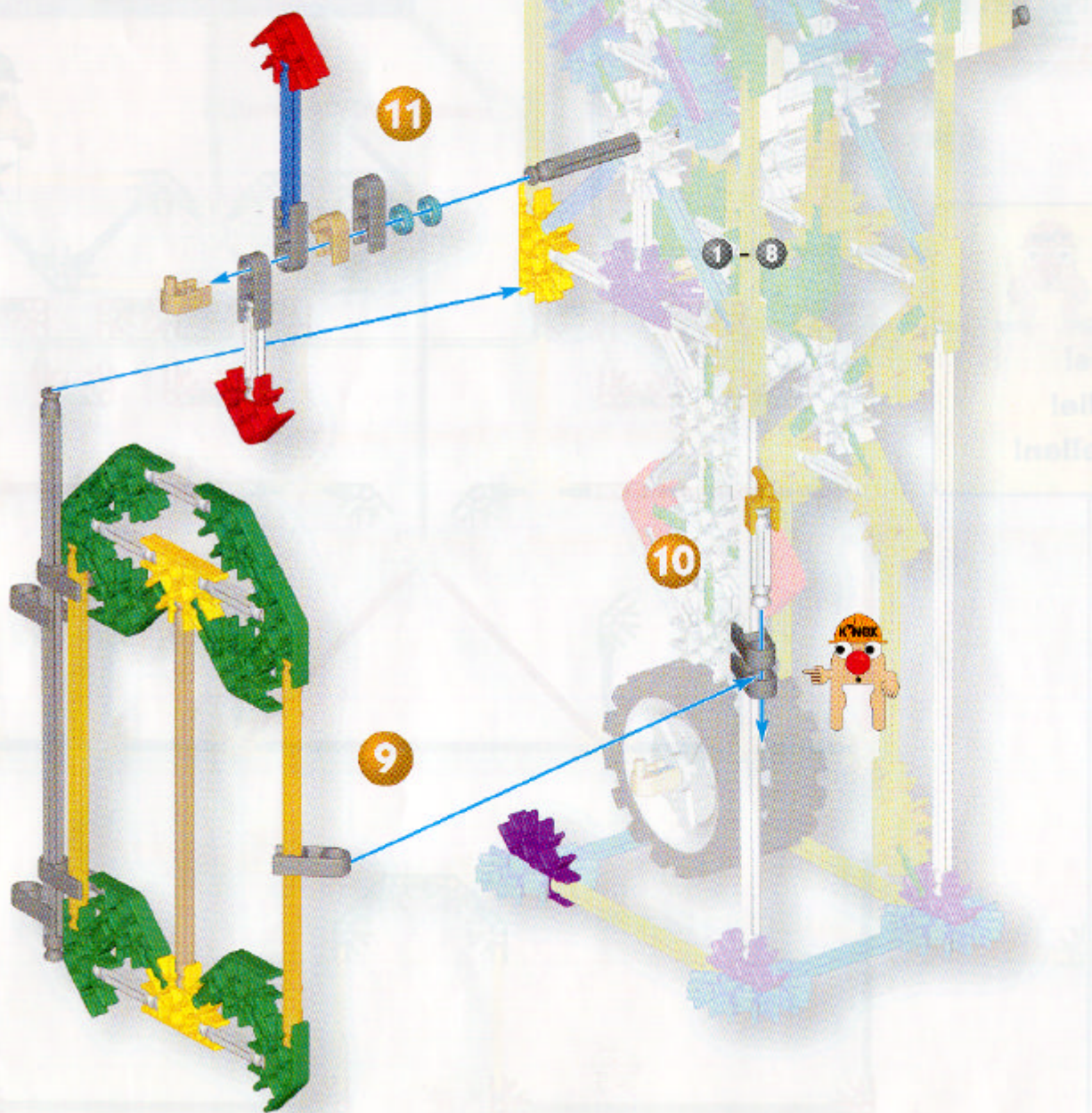

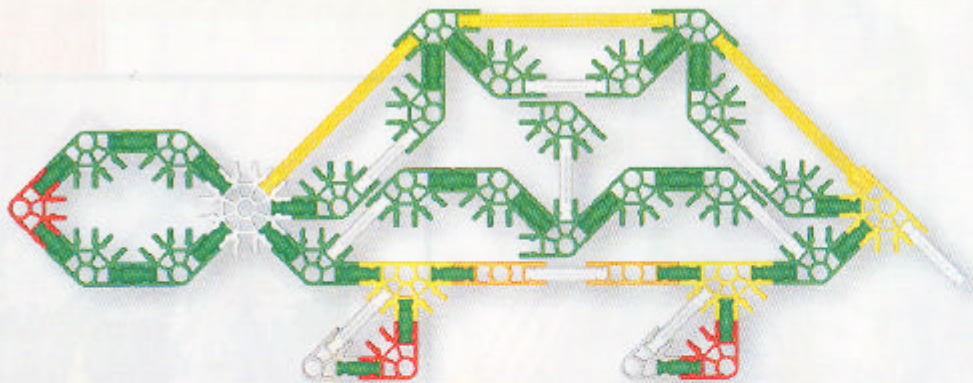

CASTLE

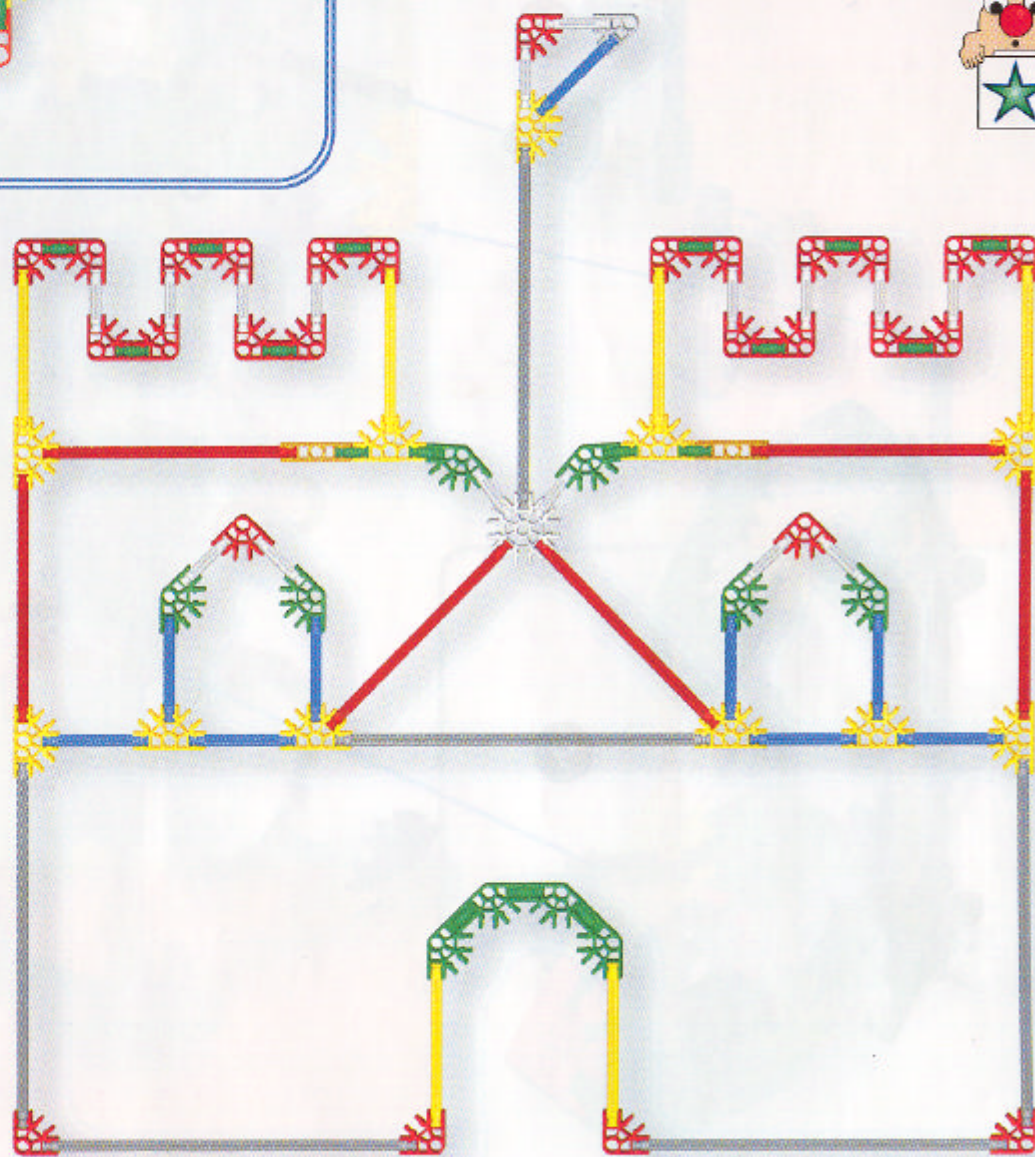

US GB **More Amazing Models!**

F **D'autres modèles tout à fait extraordinaires !**

E **¡Más modelos extraordinarios!**

D **Noch mehr raffinierte Modelle!**

NL **Nog meer fantastische modellen!**



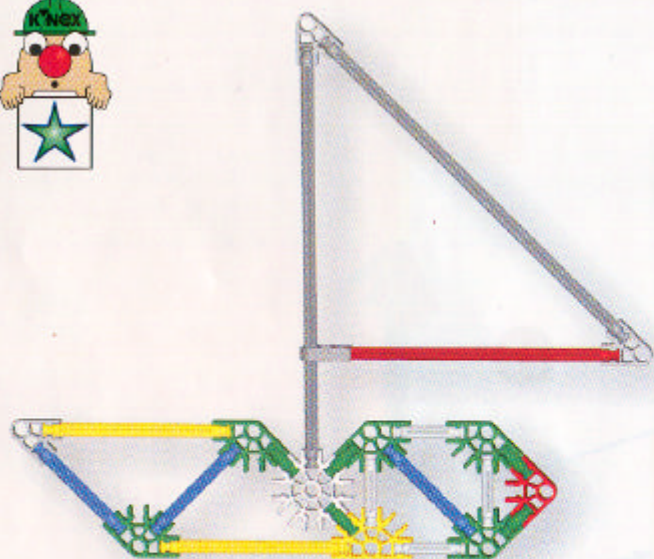

OCEAN LINER

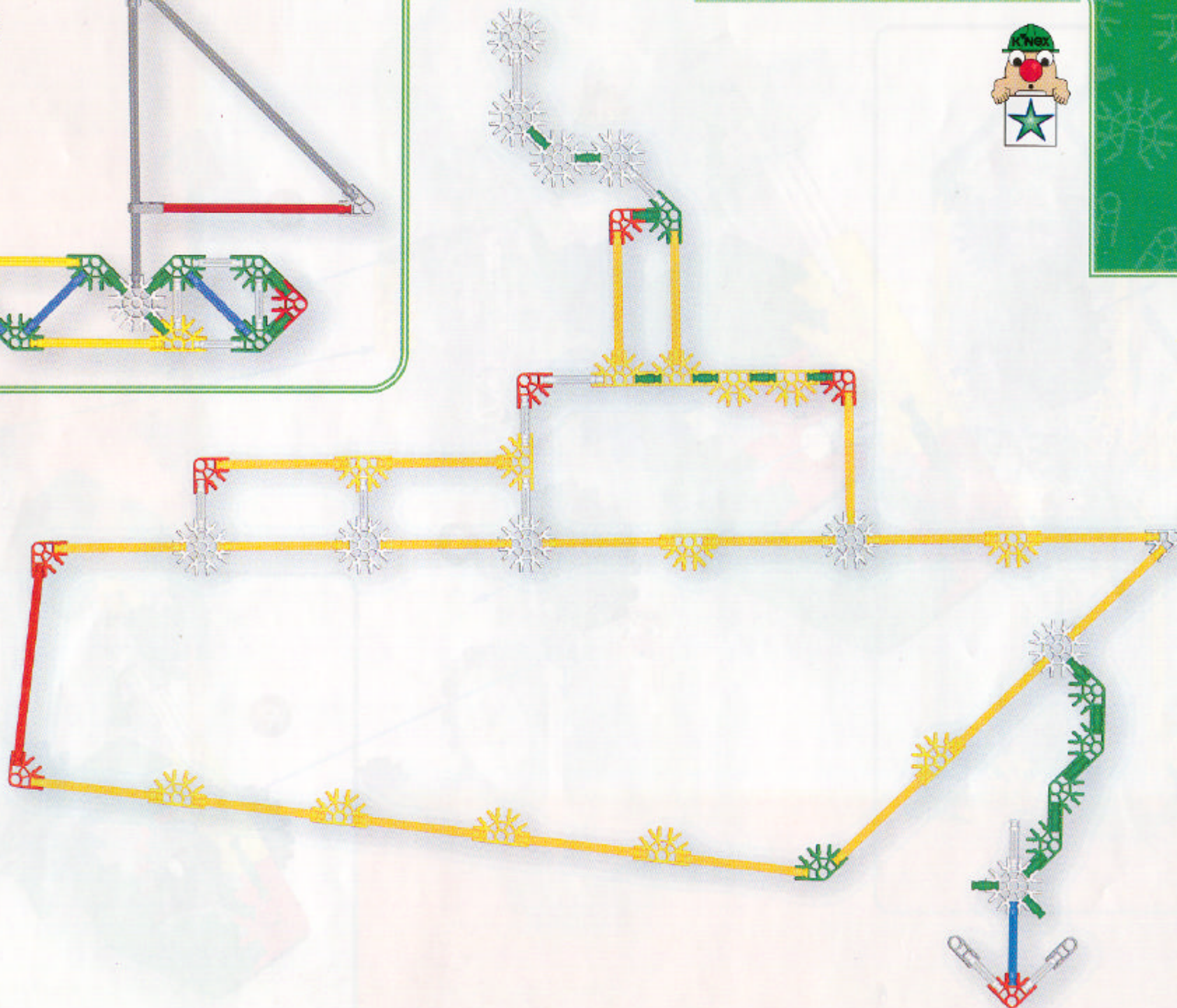

FISH

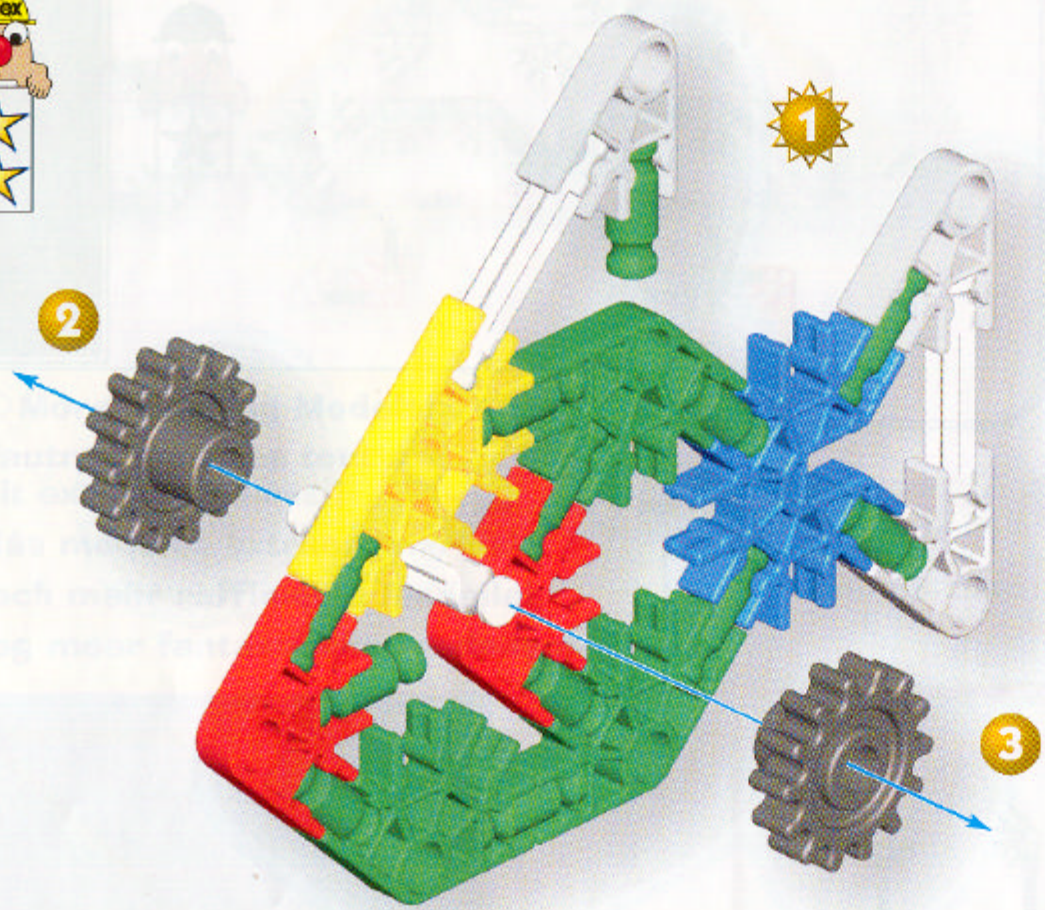

PICTURE FRAME 1



1

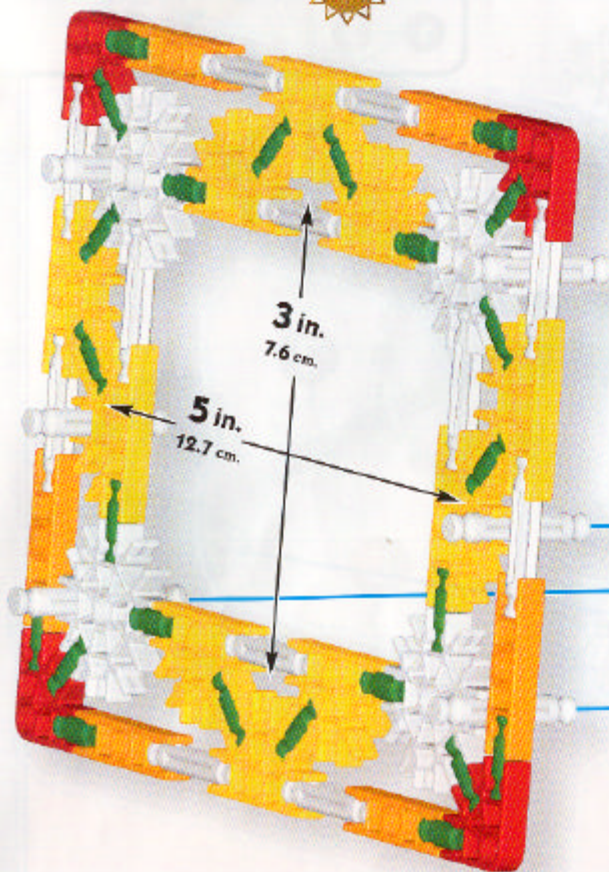

3 in.
7.6 cm.

5 in.
12.7 cm.

2

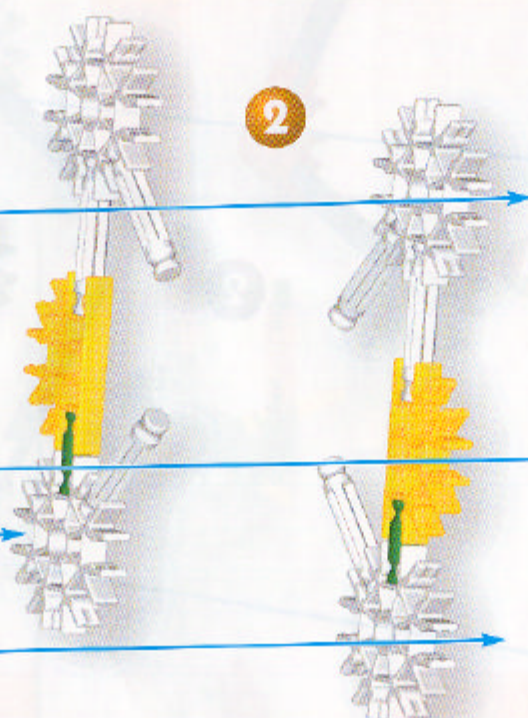

3

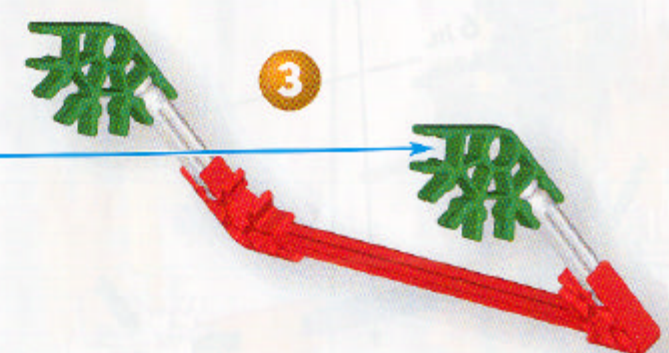



1

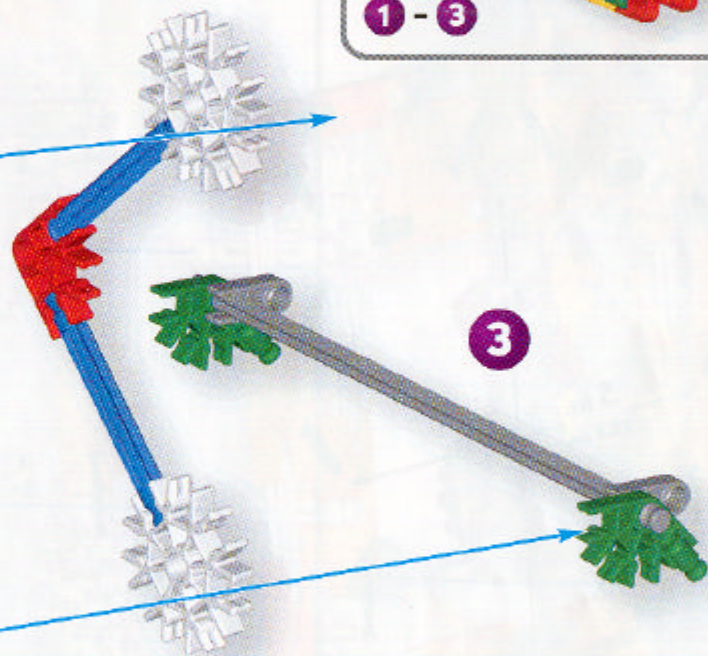
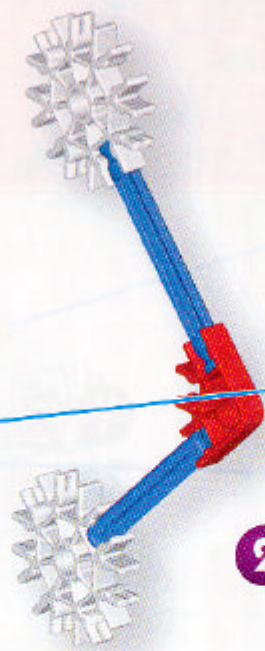
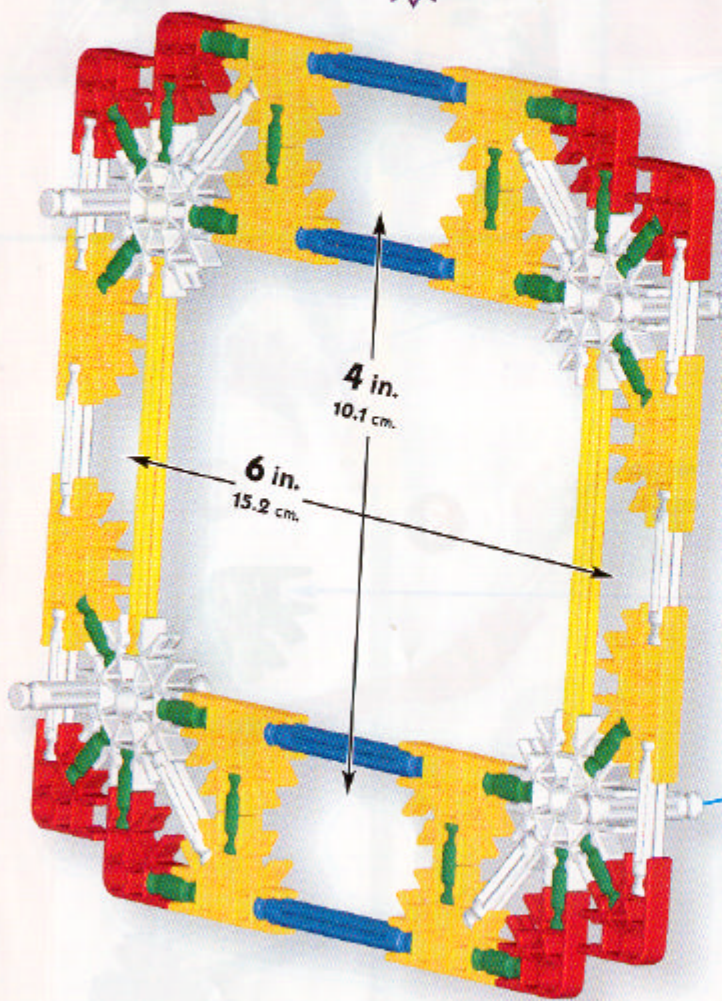



1

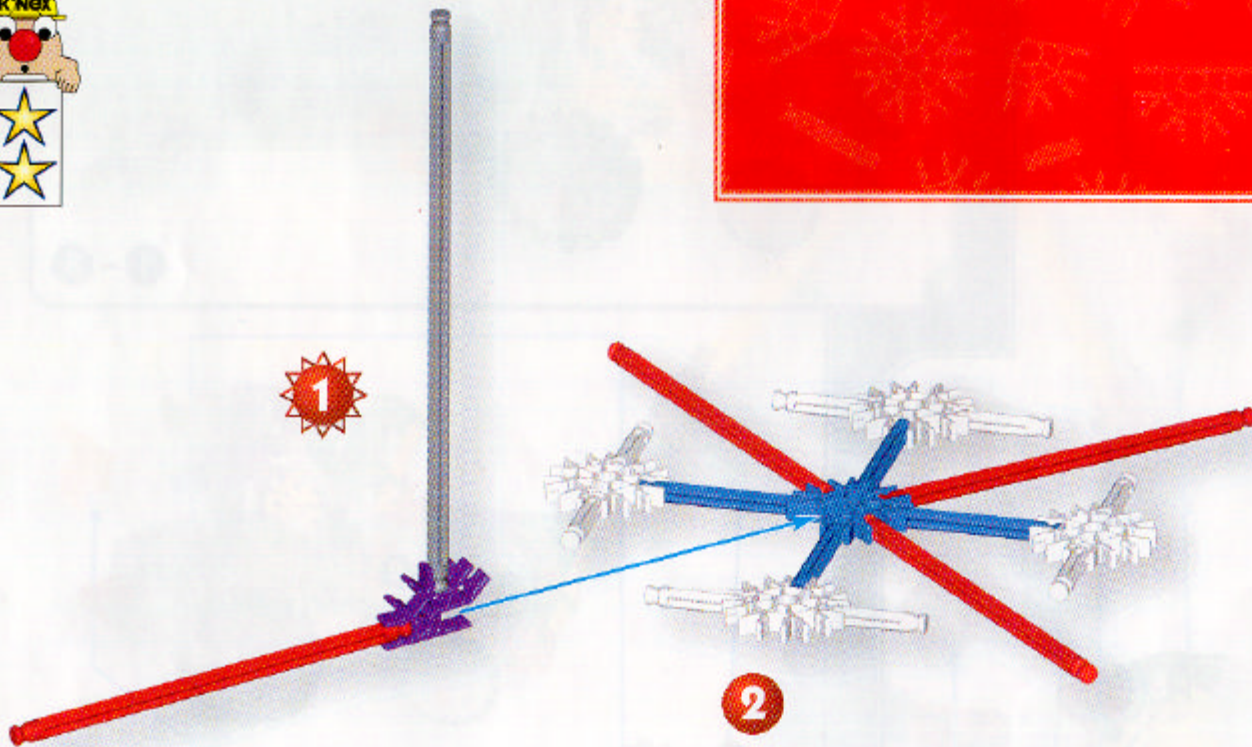

2

1 - 2

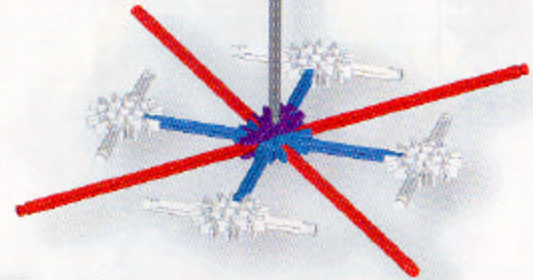

3

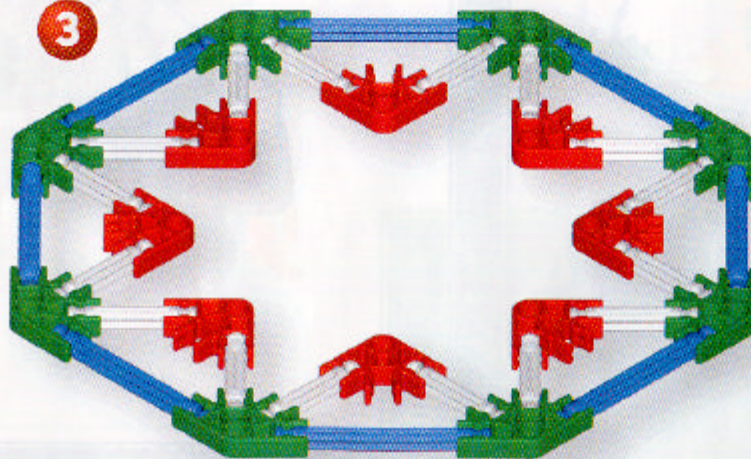

1 - 3

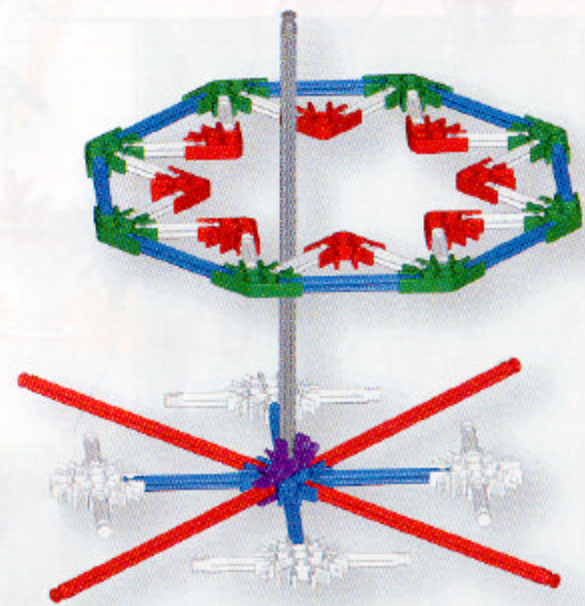

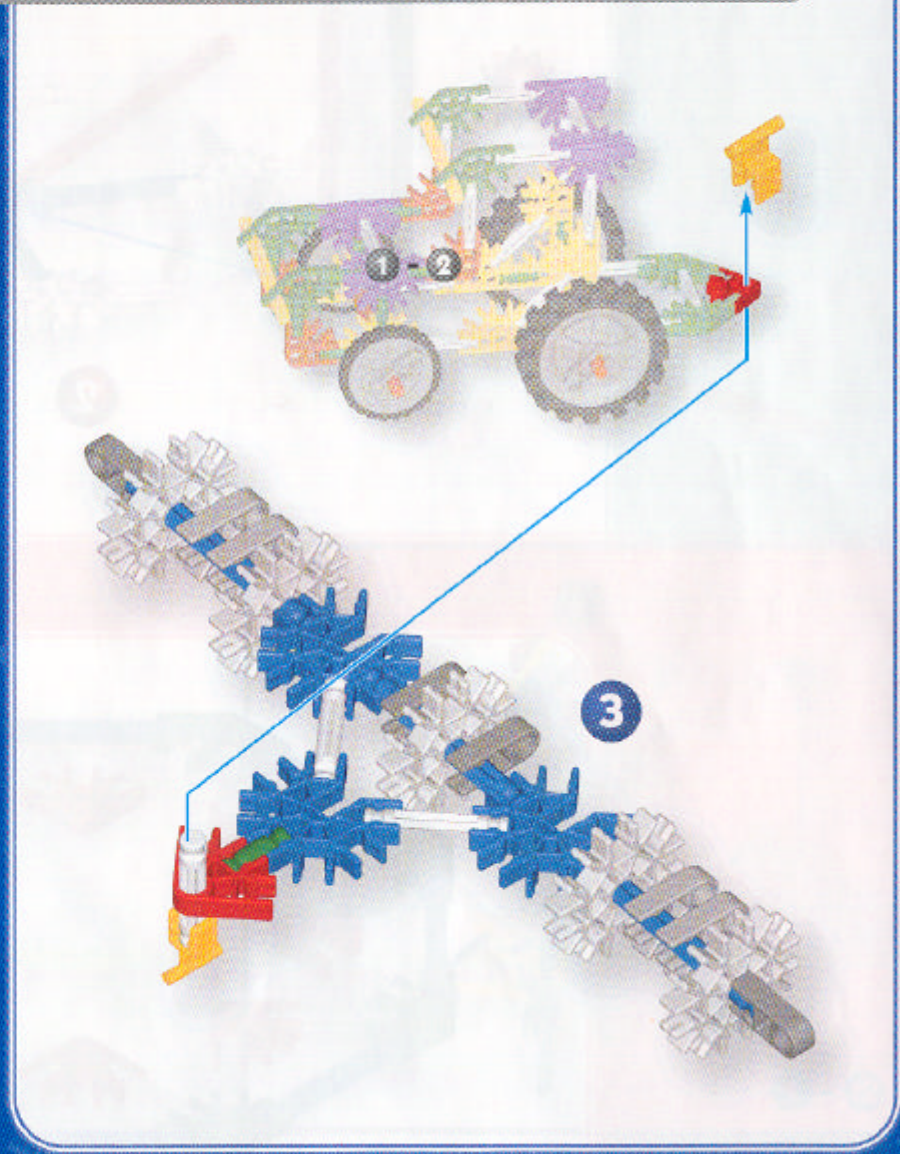
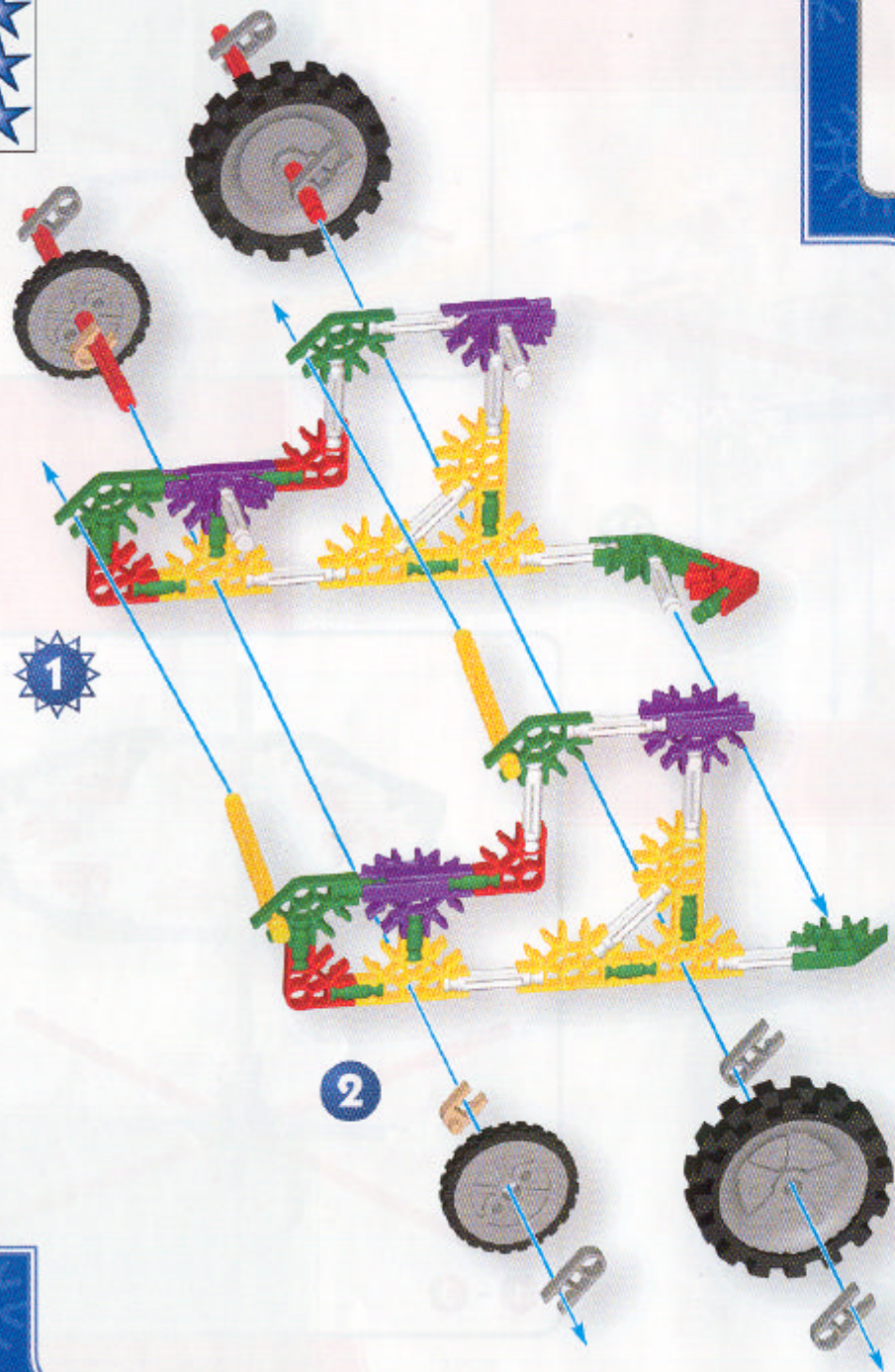

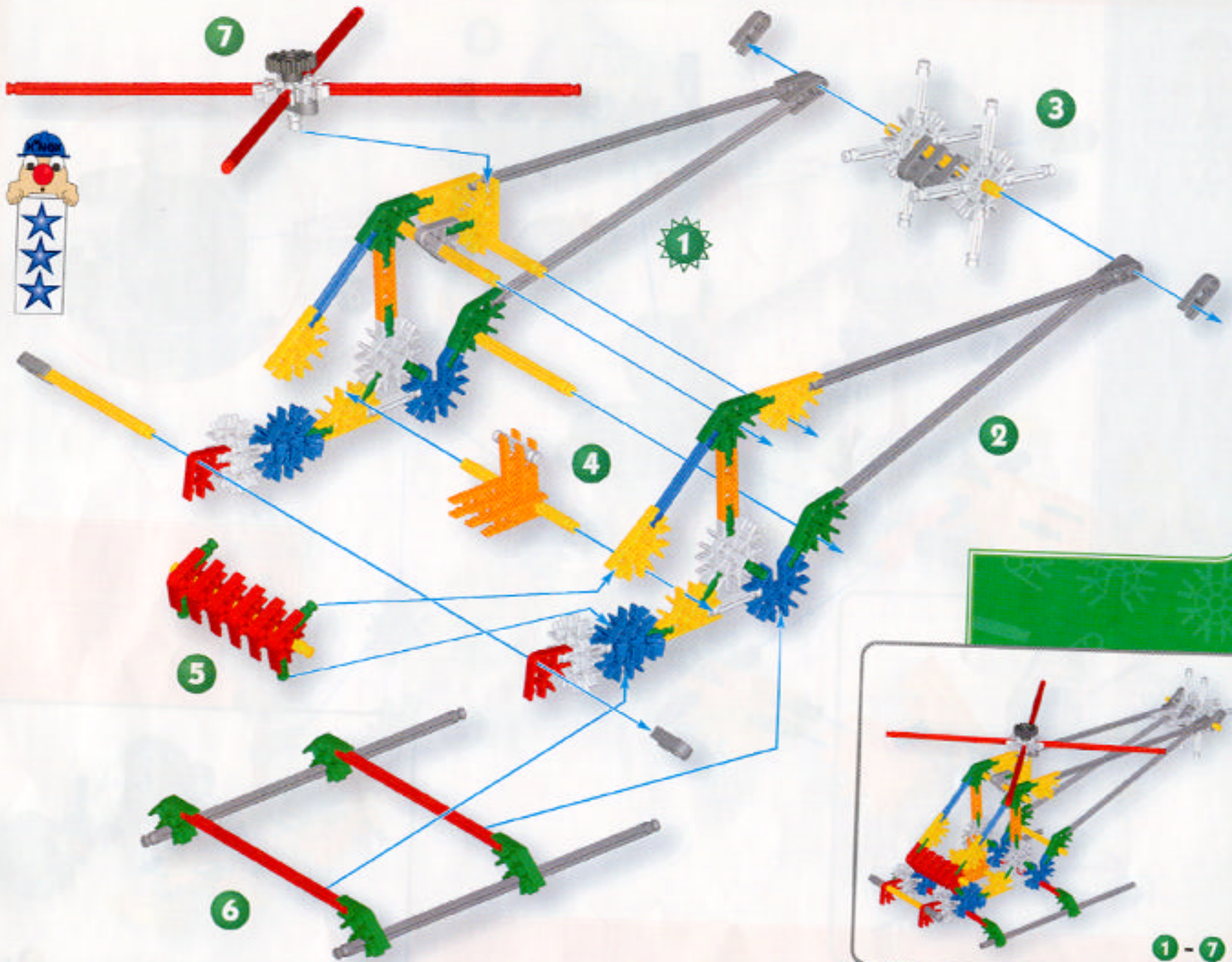

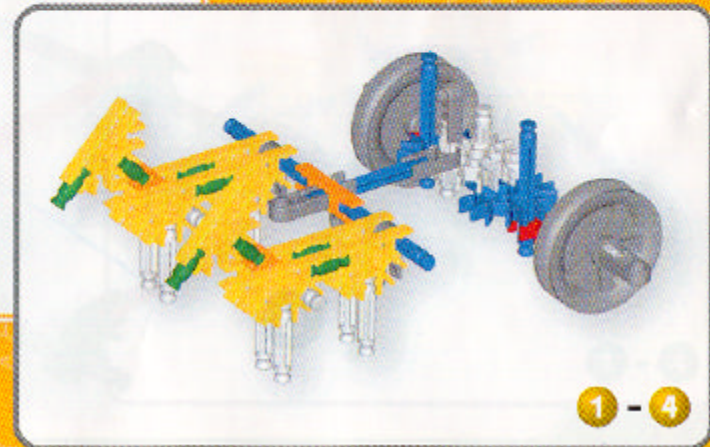
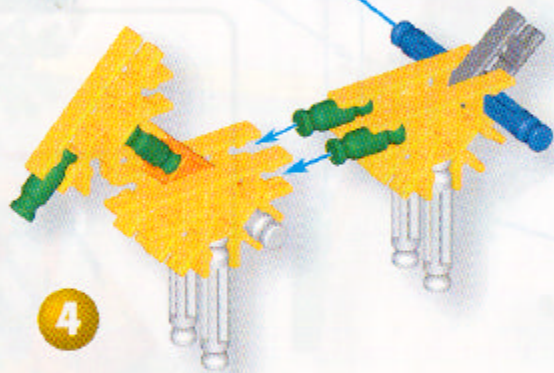
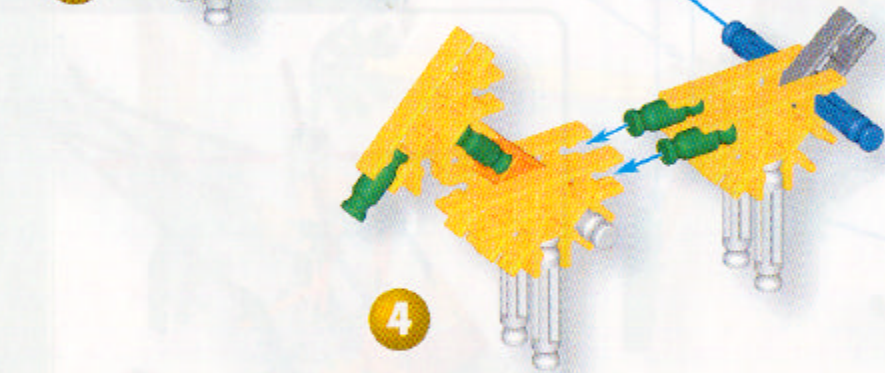
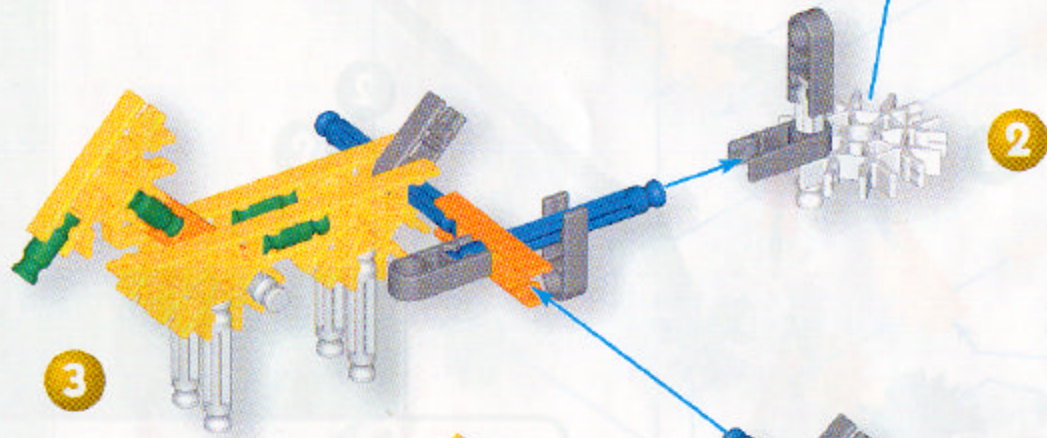
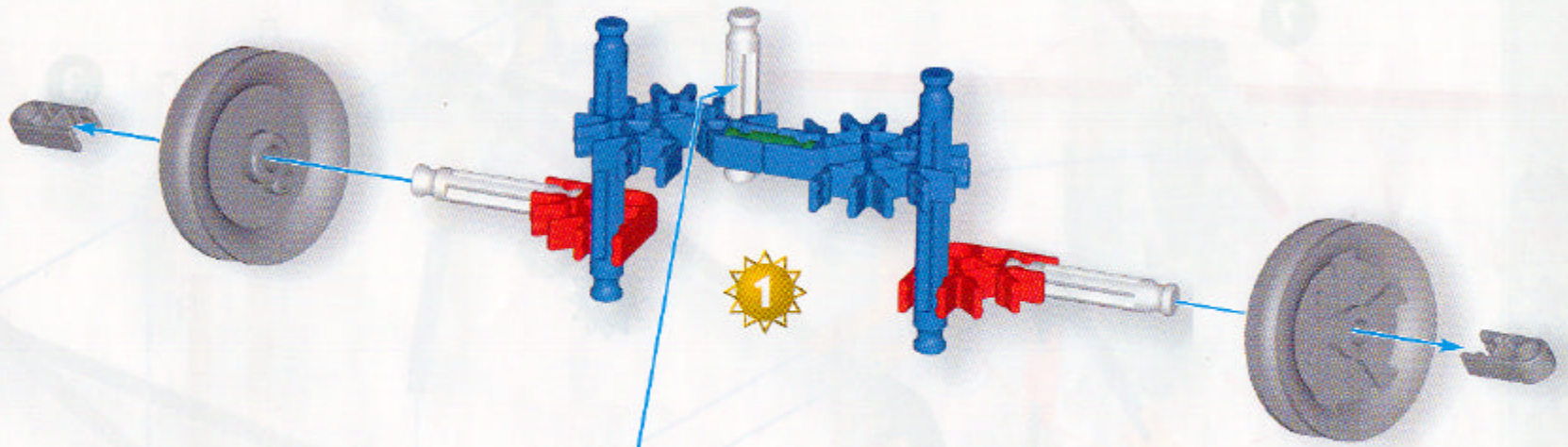

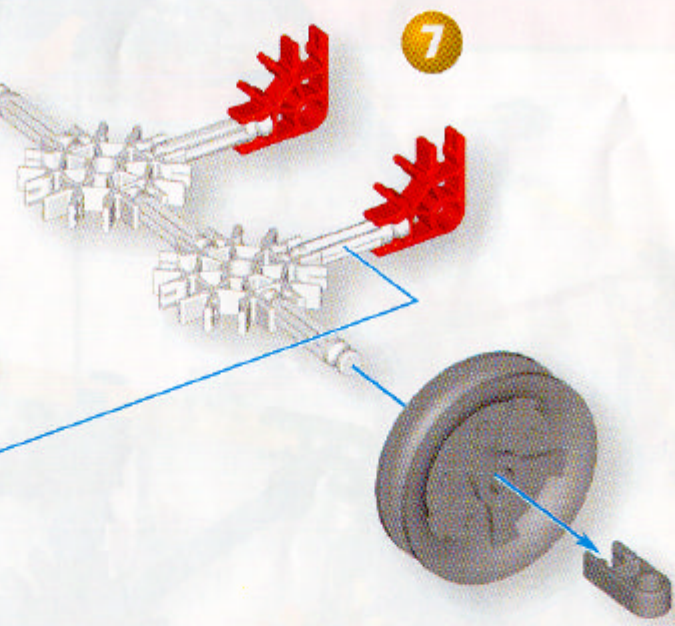
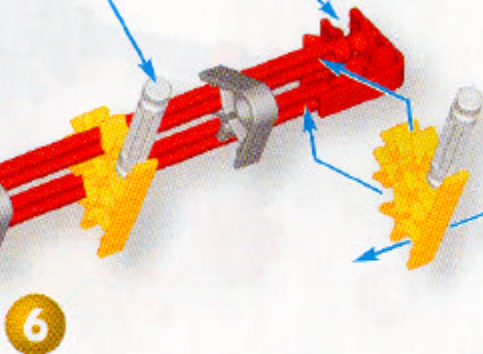
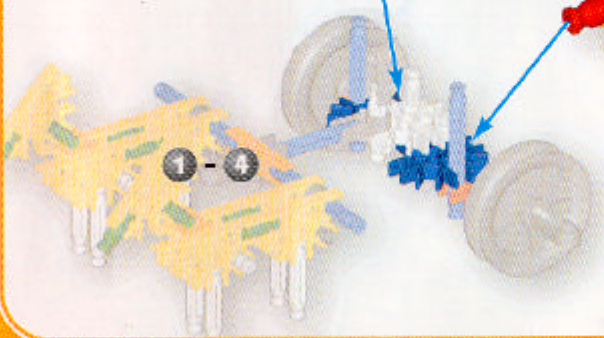
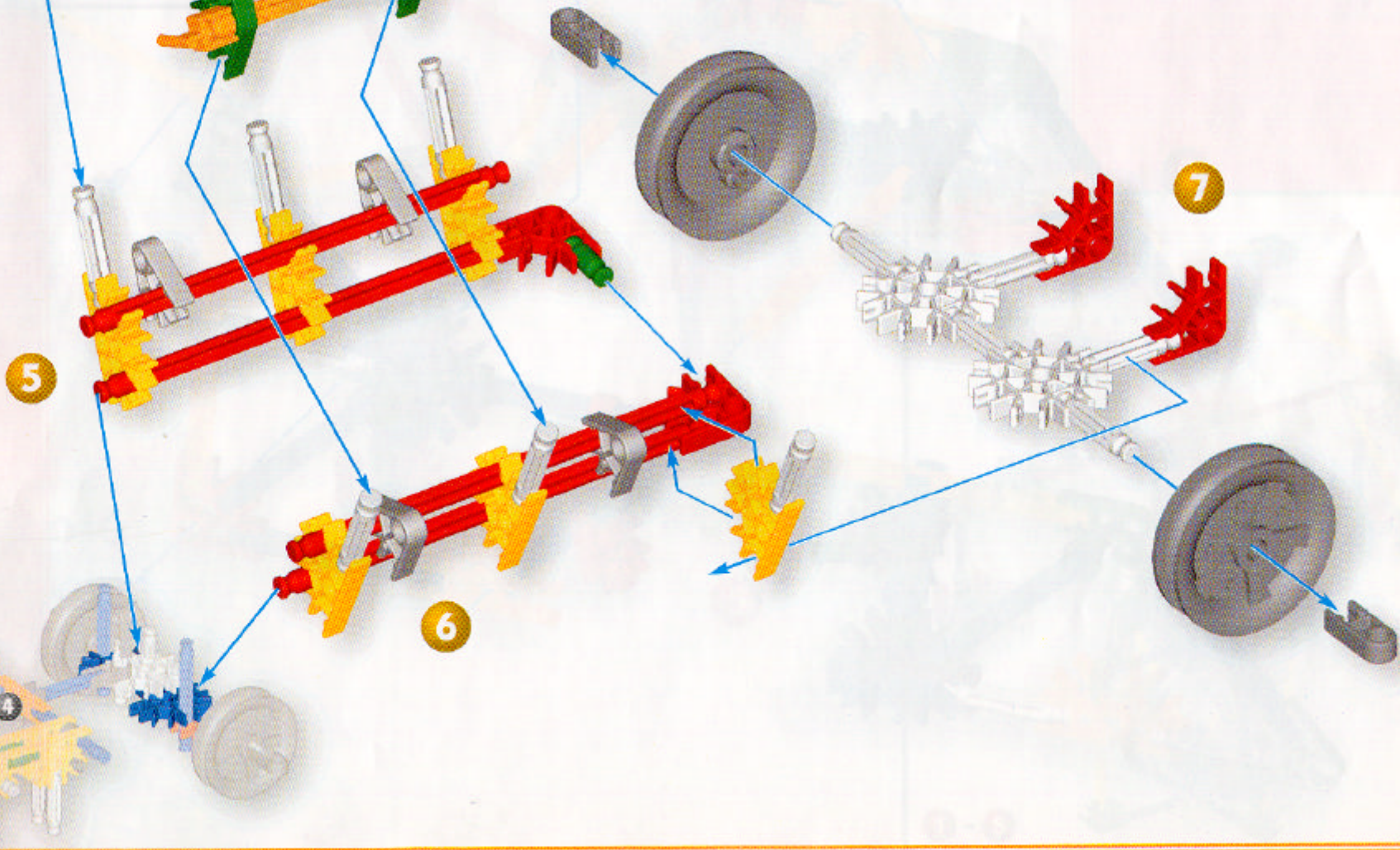
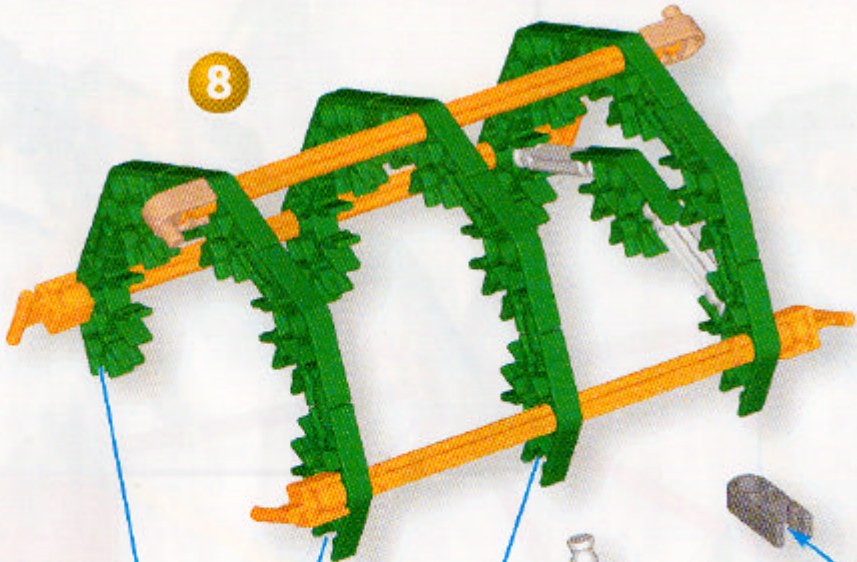

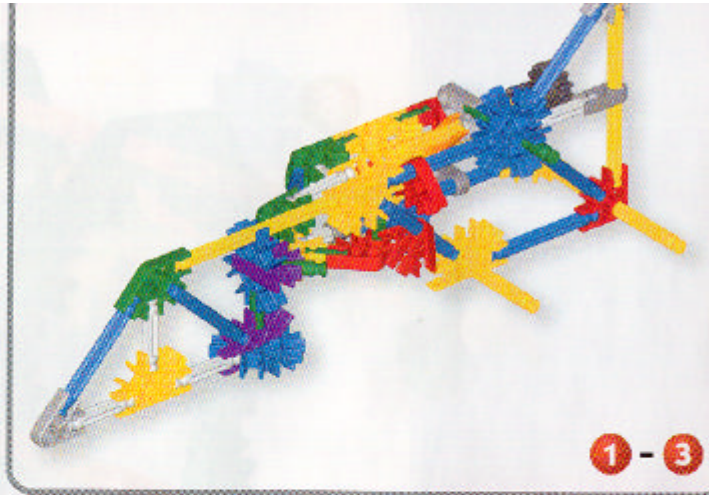
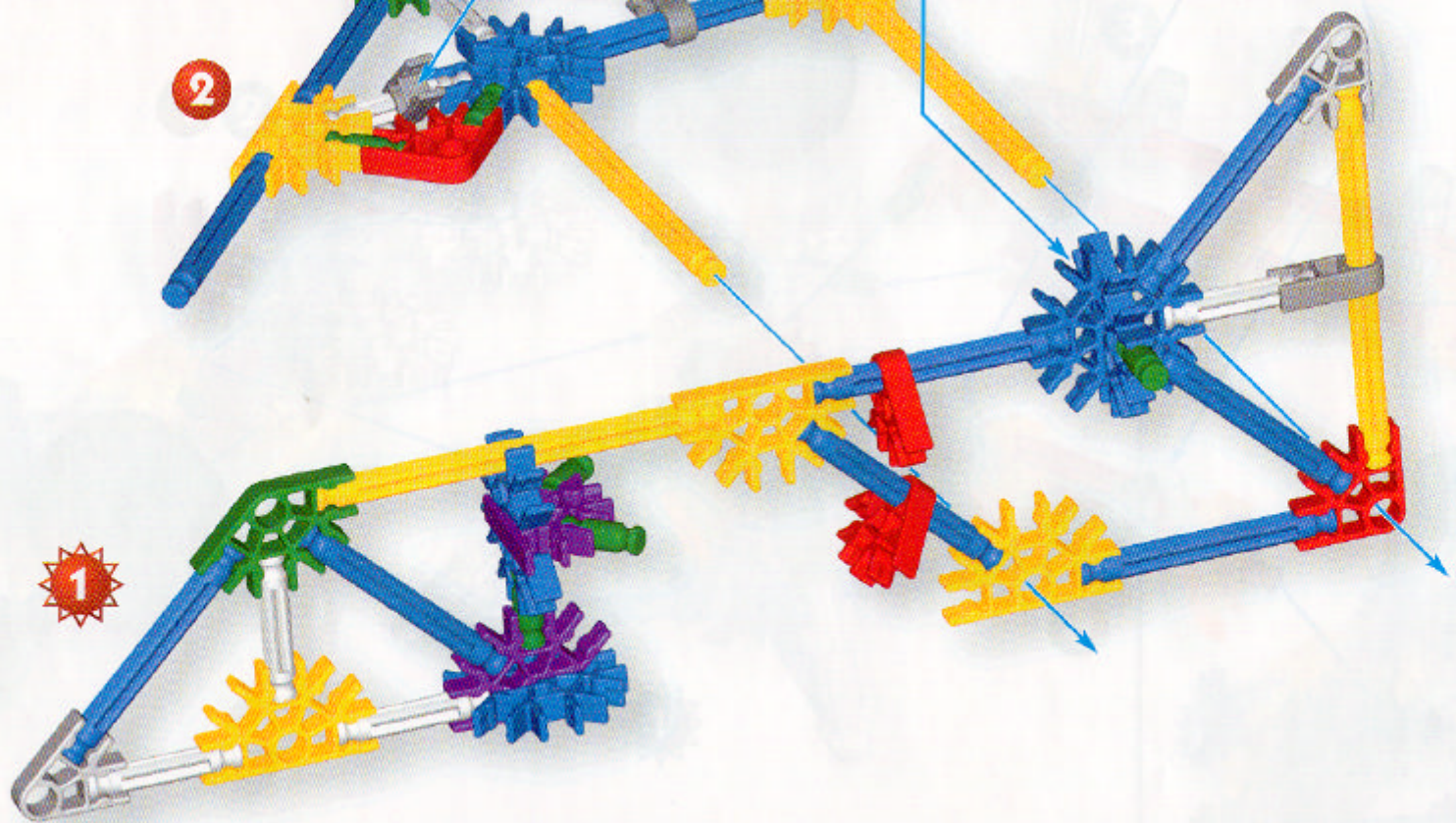

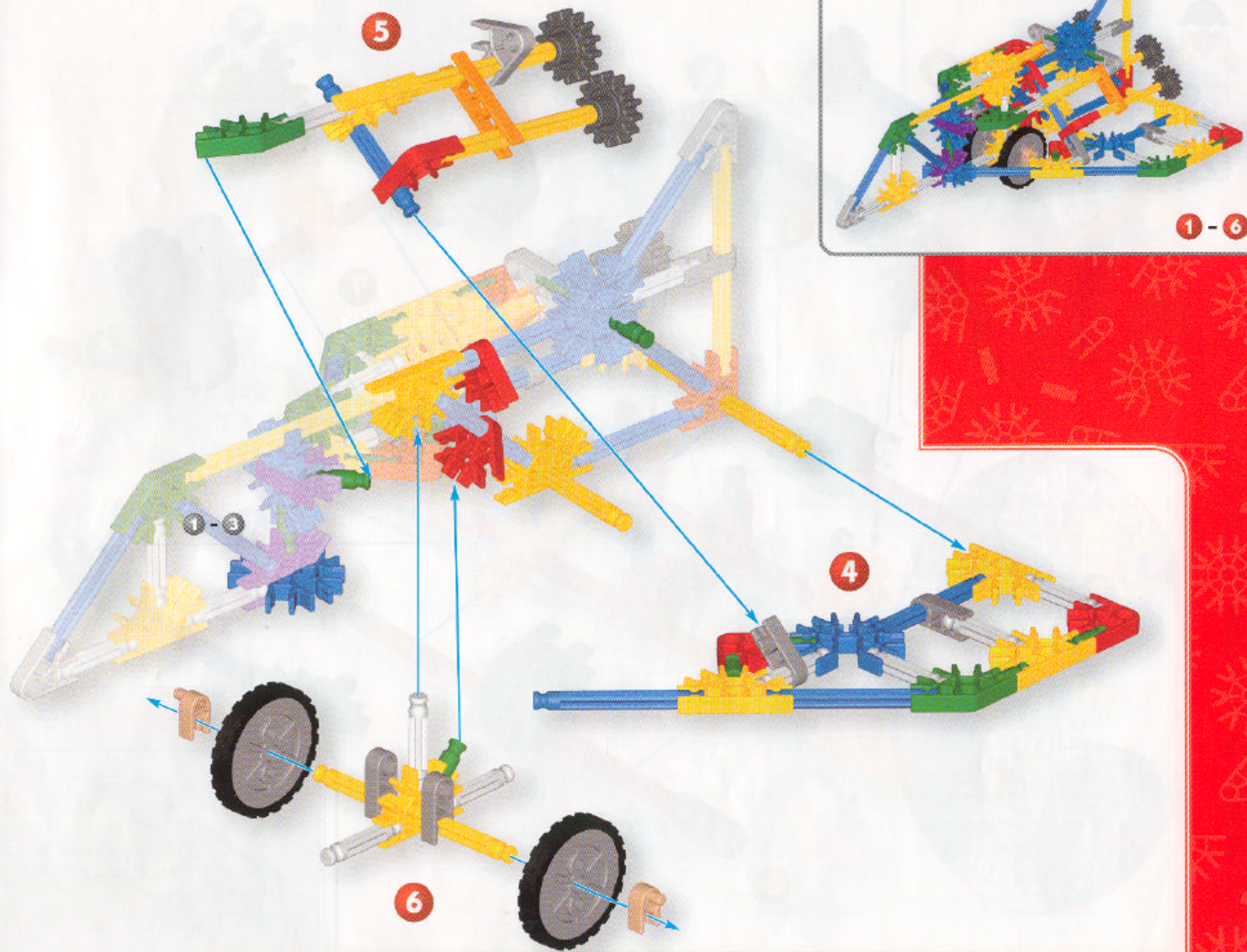

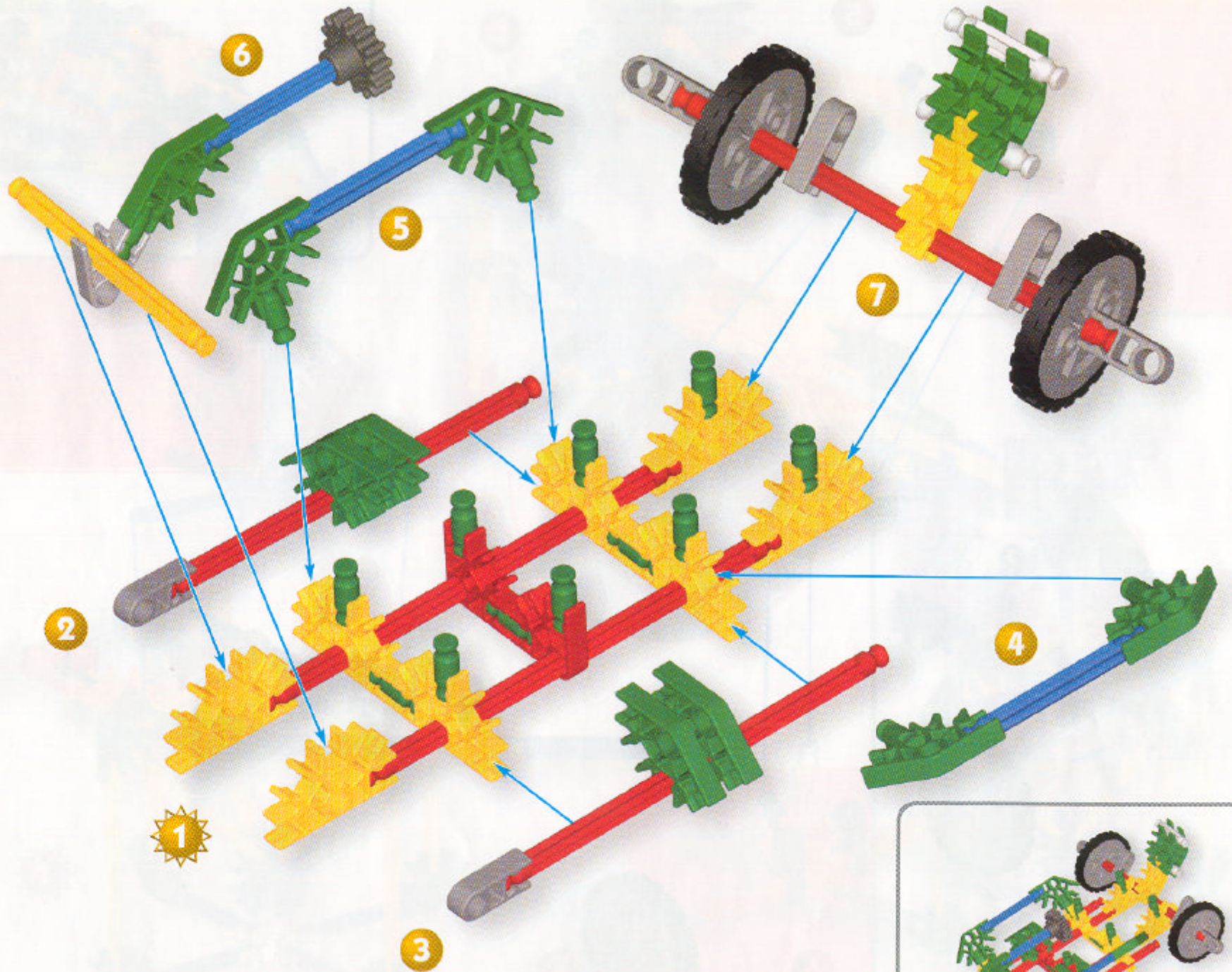

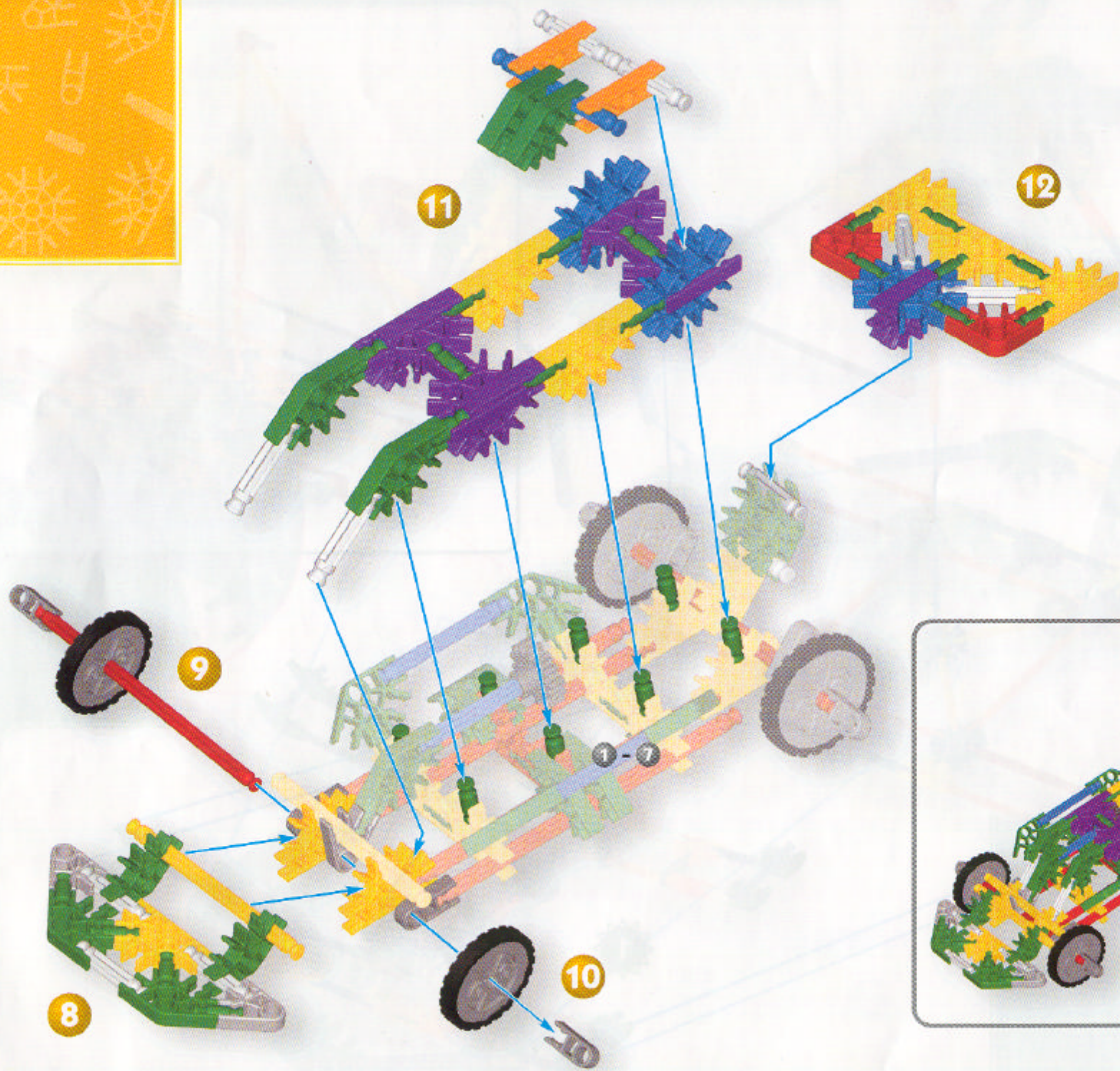

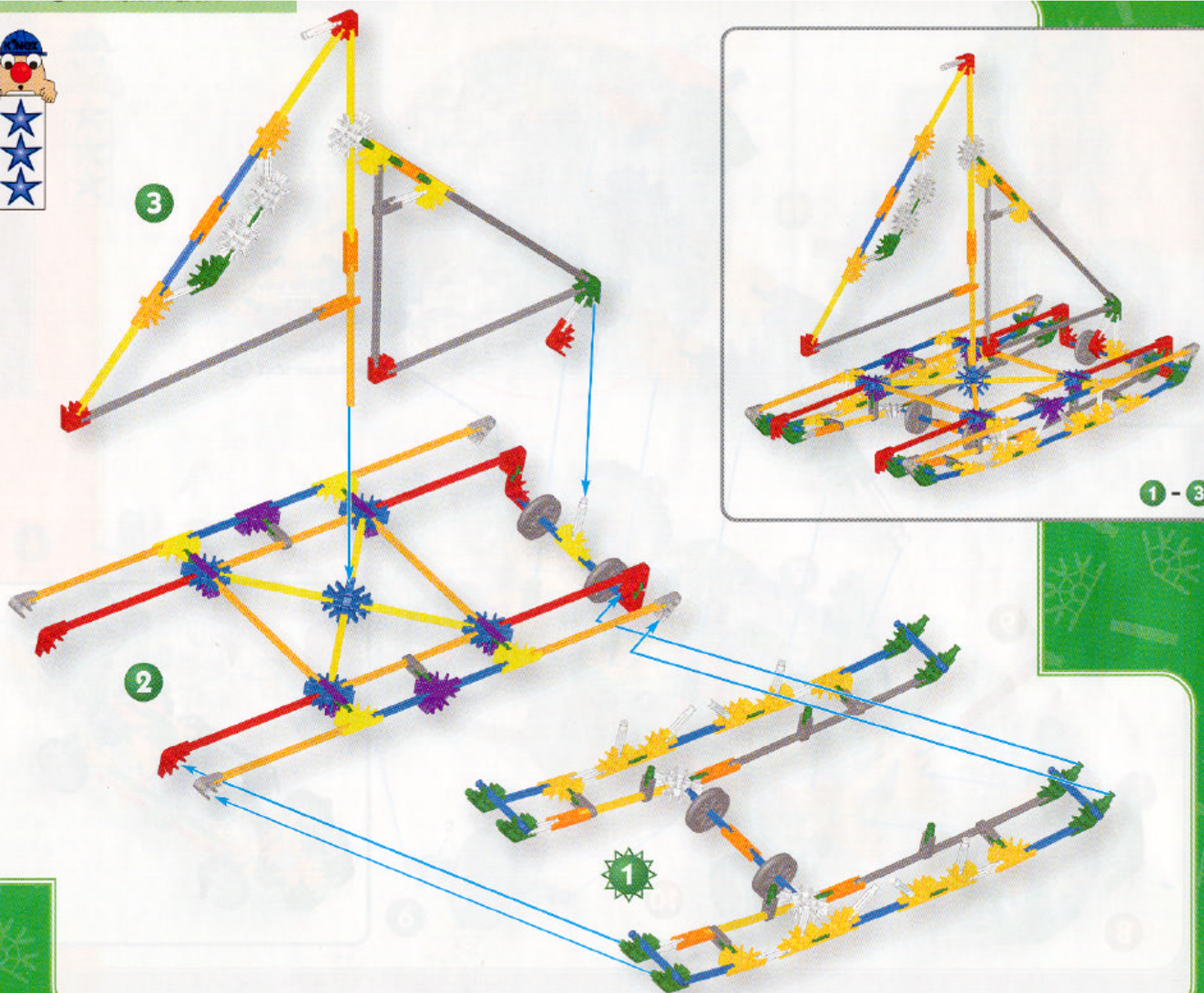

3

2

1

1 - 3

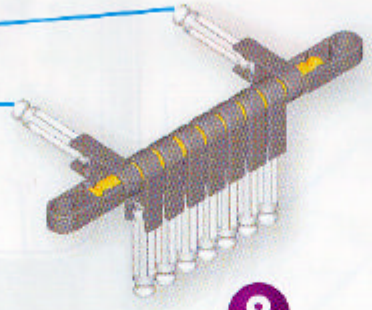
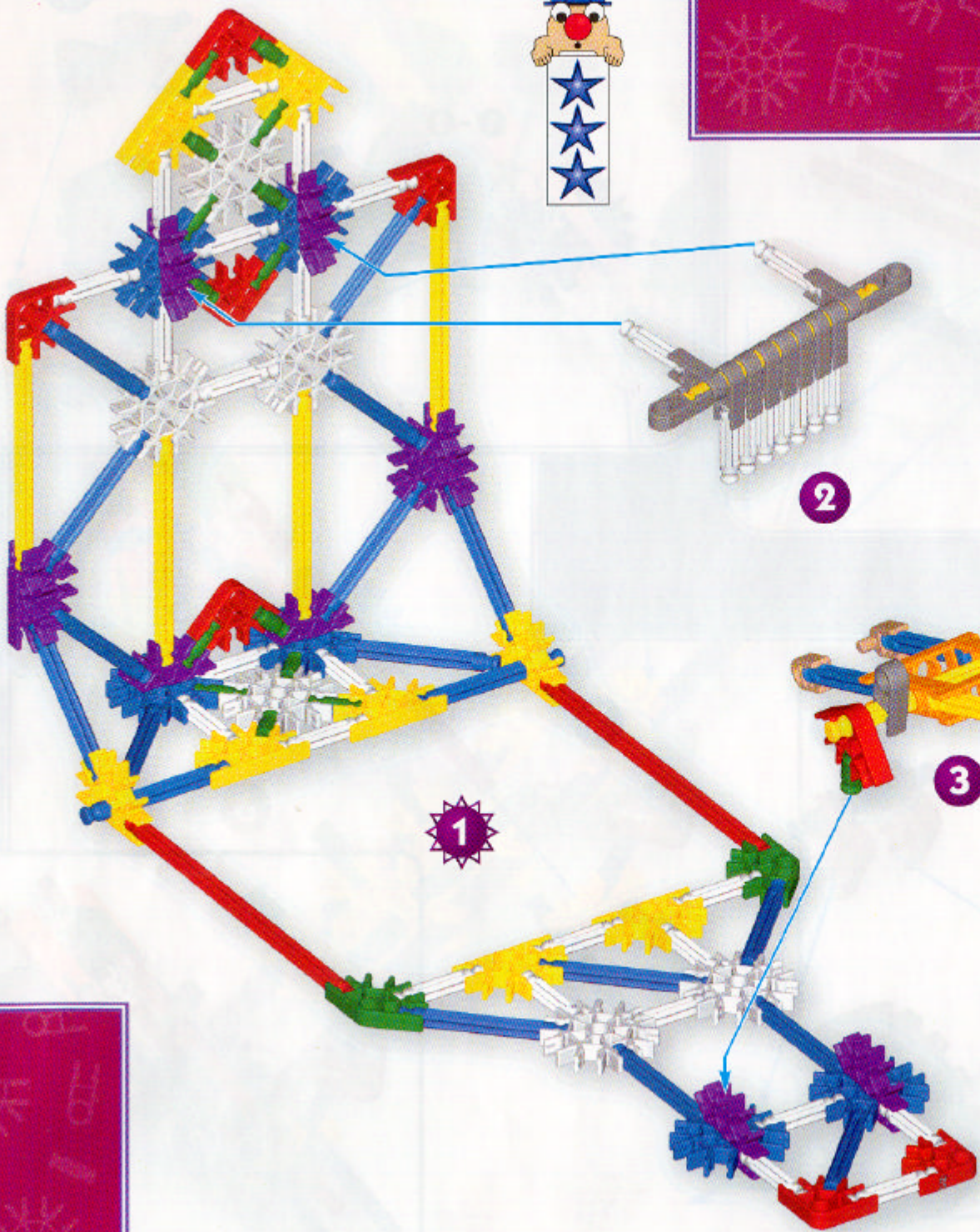

2



1 - 3

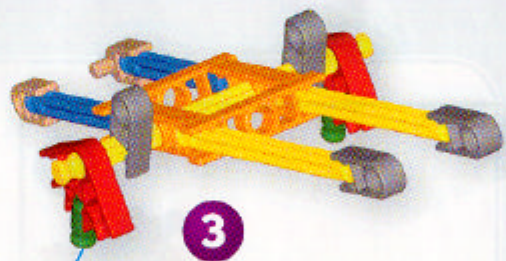

3





2

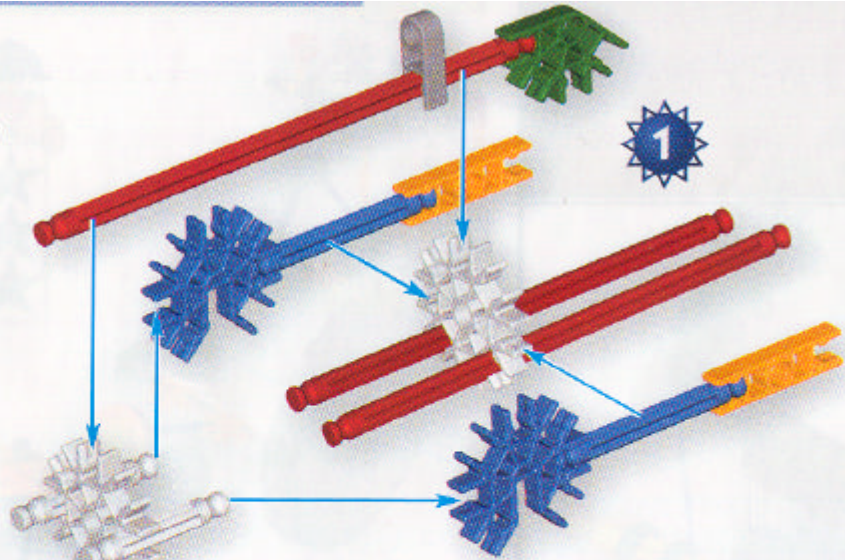

1

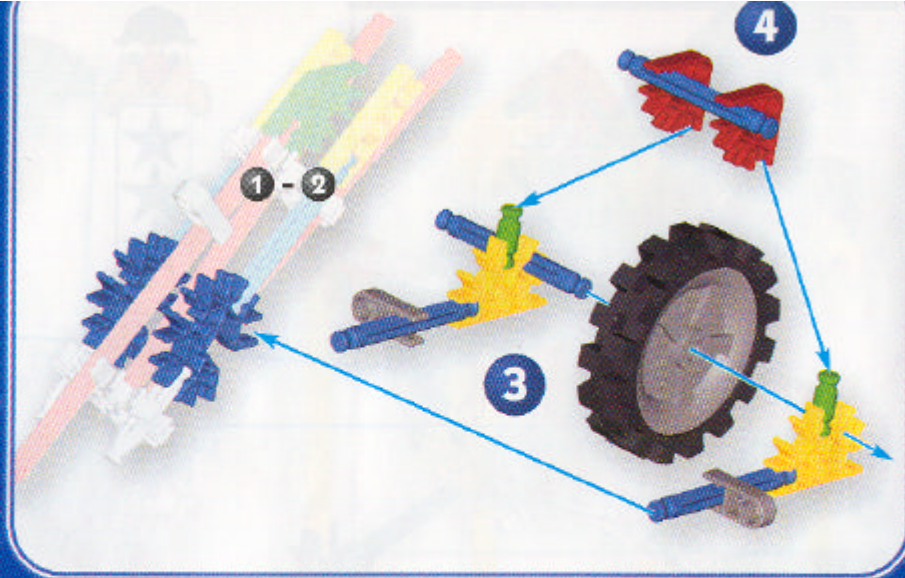

1-2

3

4

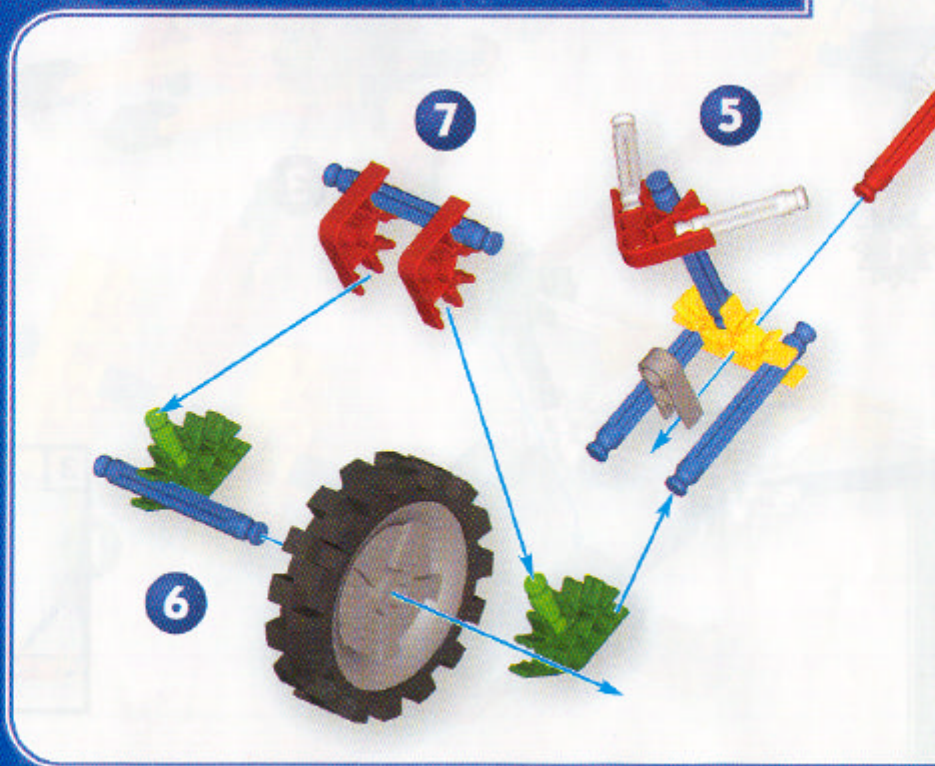

7

5

6



1-4

1-7

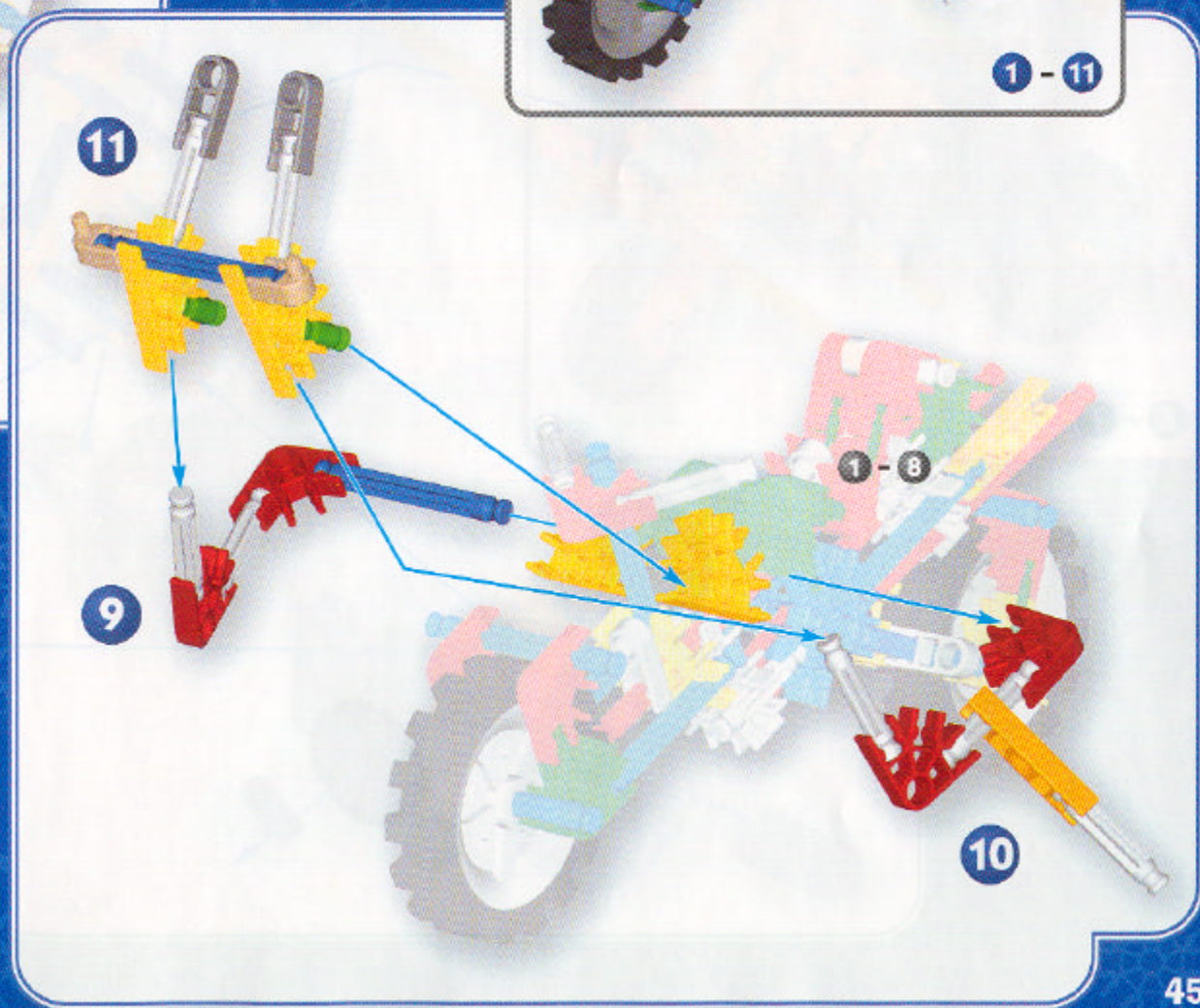



1



2

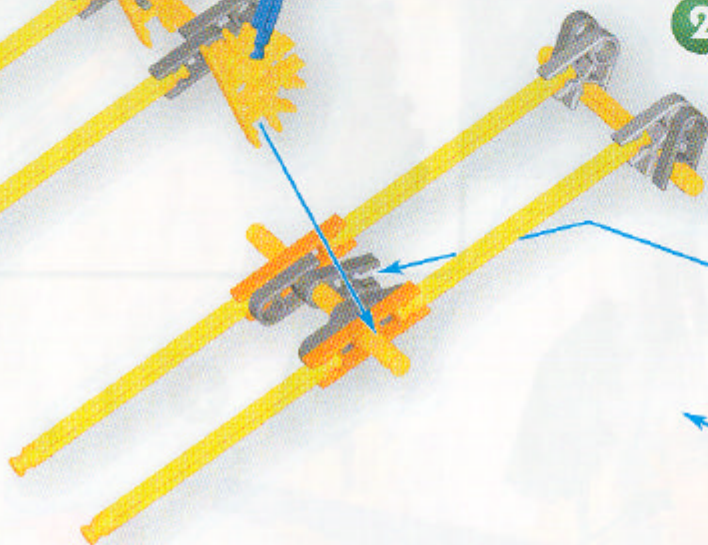

3

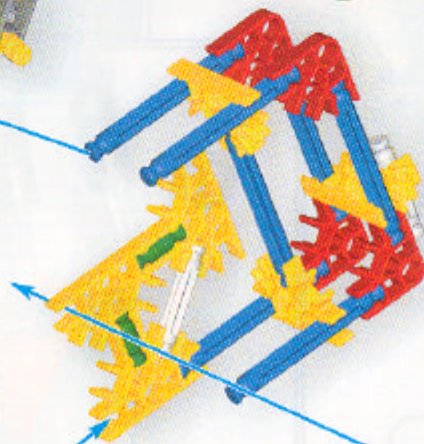

4

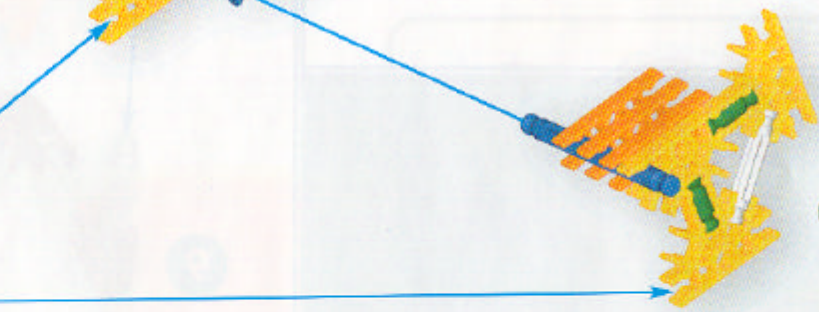

5

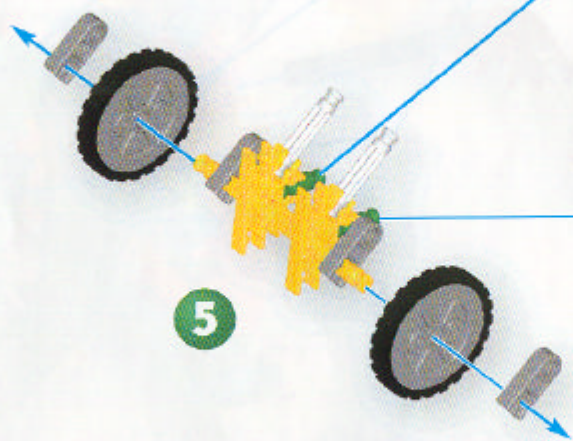

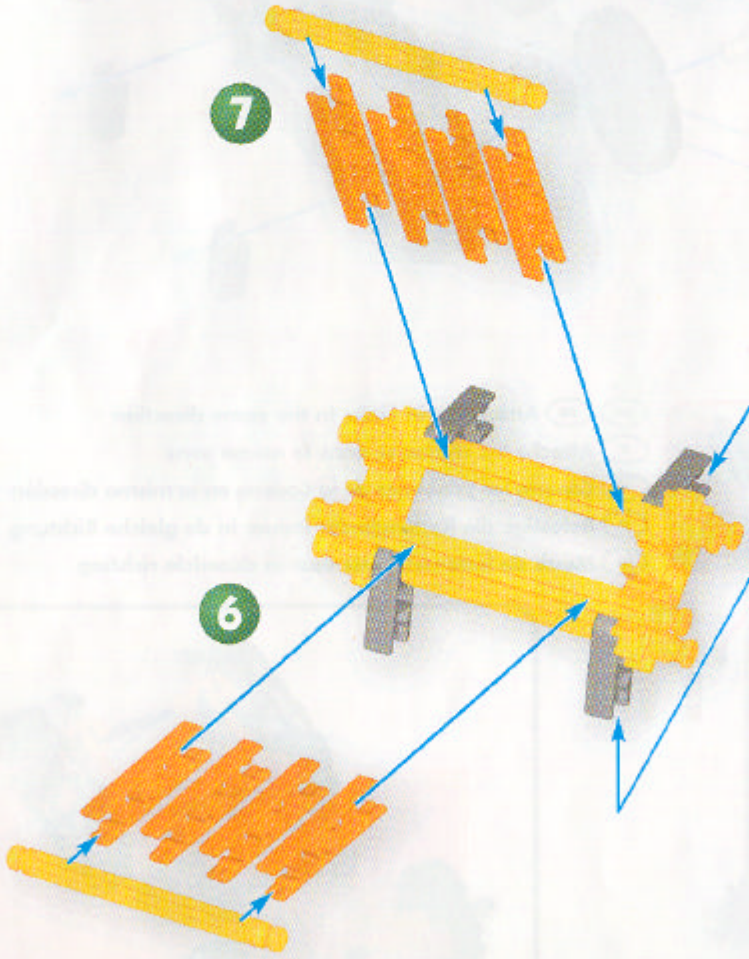
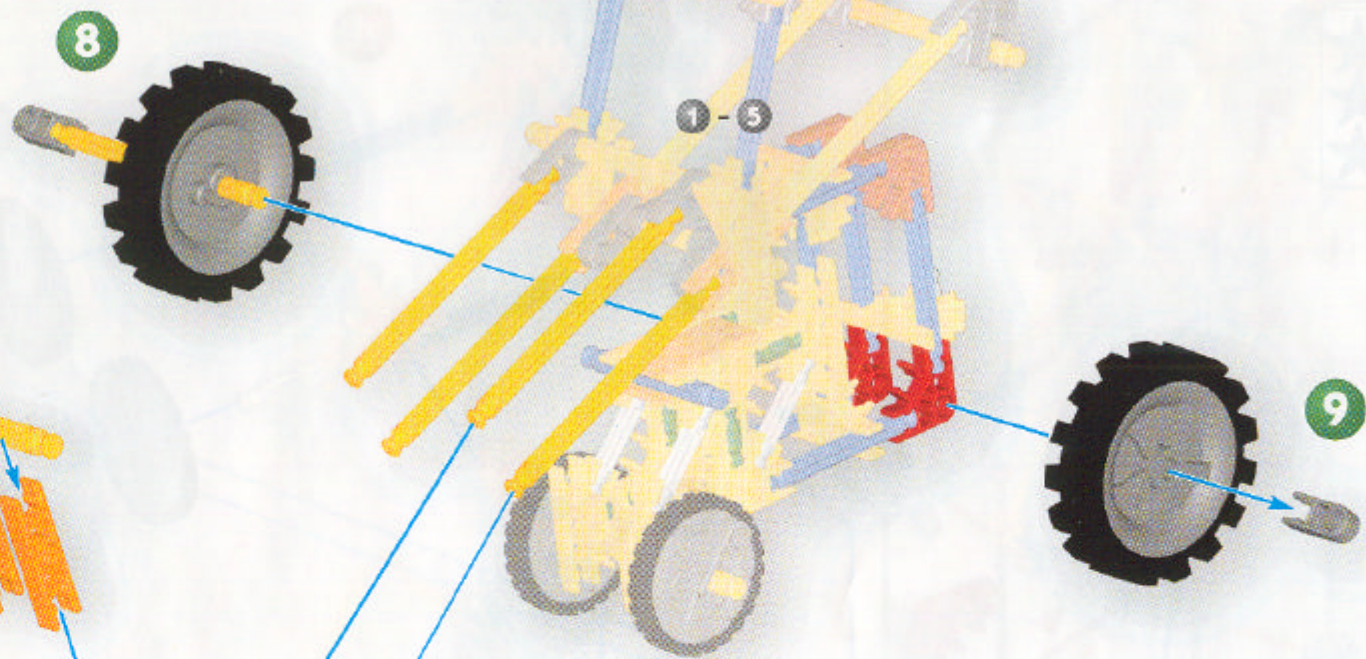

x12

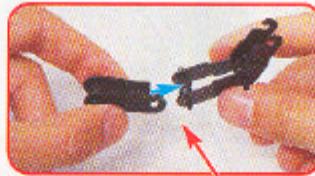
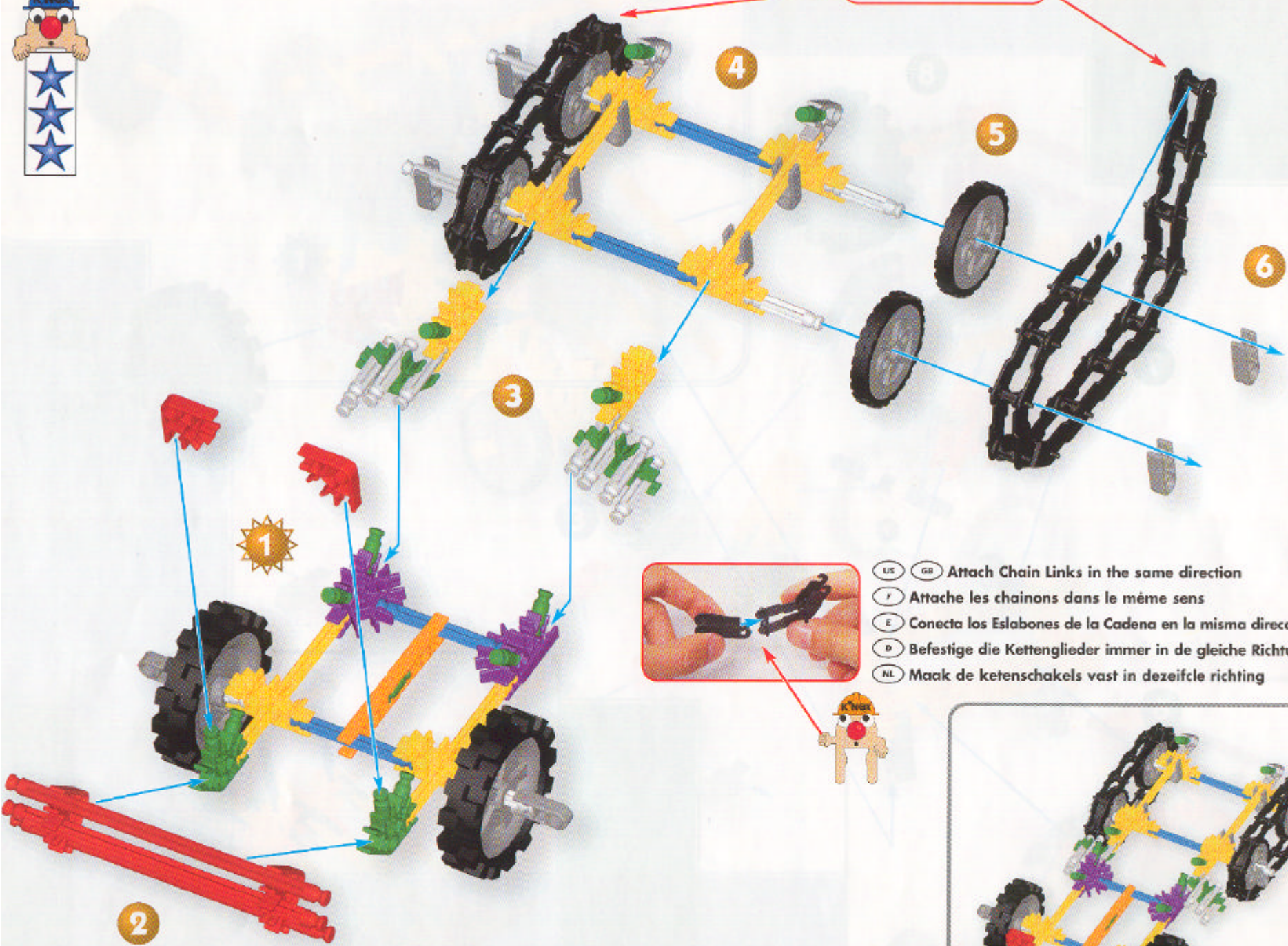

- (UK) (GR) Attach Chain Links in the same direction
- (F) Attache les chainons dans le même sens
- (E) Conecta los Eslabones de la Cadena en la misma dirección
- (D) Befestige die Kettenglieder immer in de gleiche Richtung
- (NL) Maak de ketenschakels vast in dezezelfde richting



8

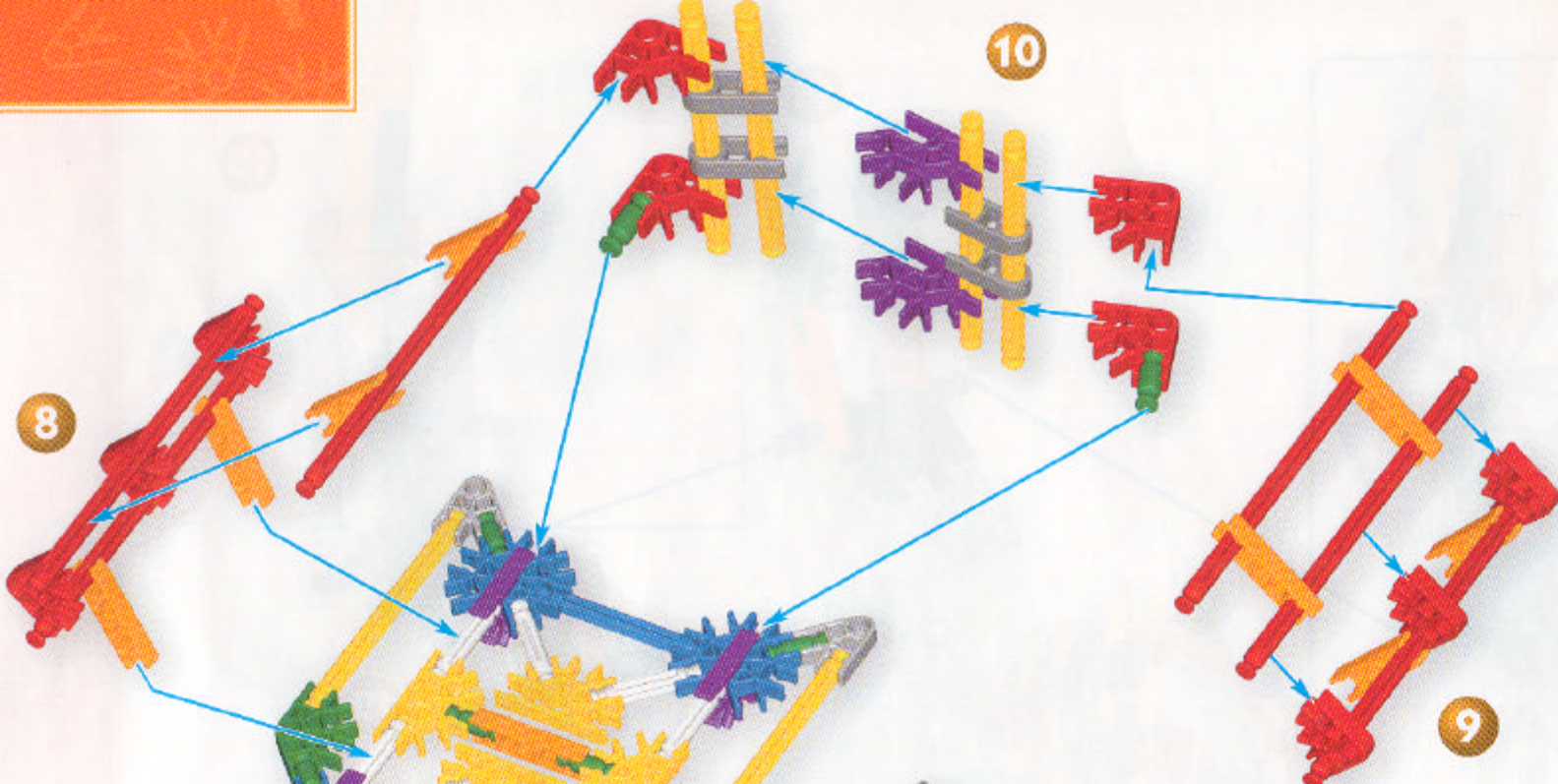

10

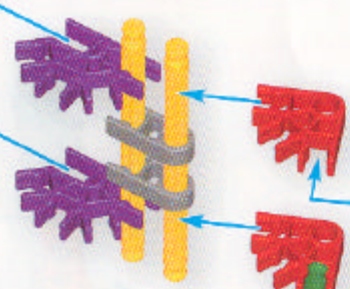

9

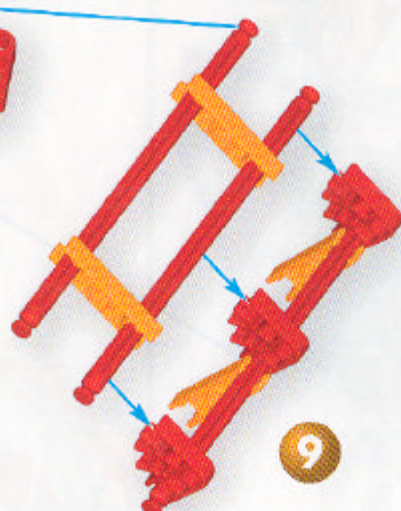

7

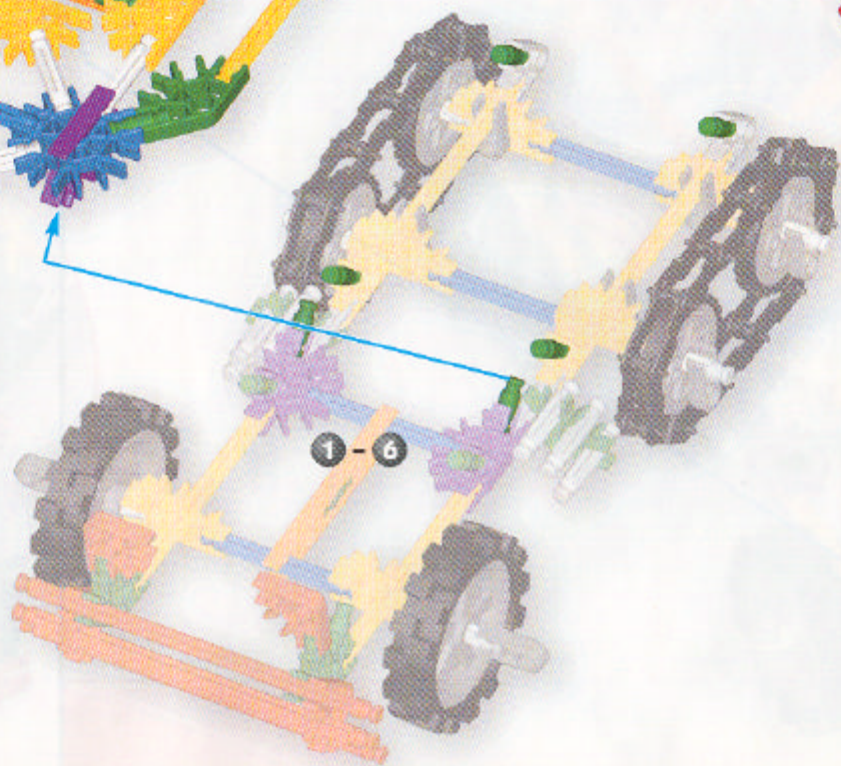

1-6



1 - 10

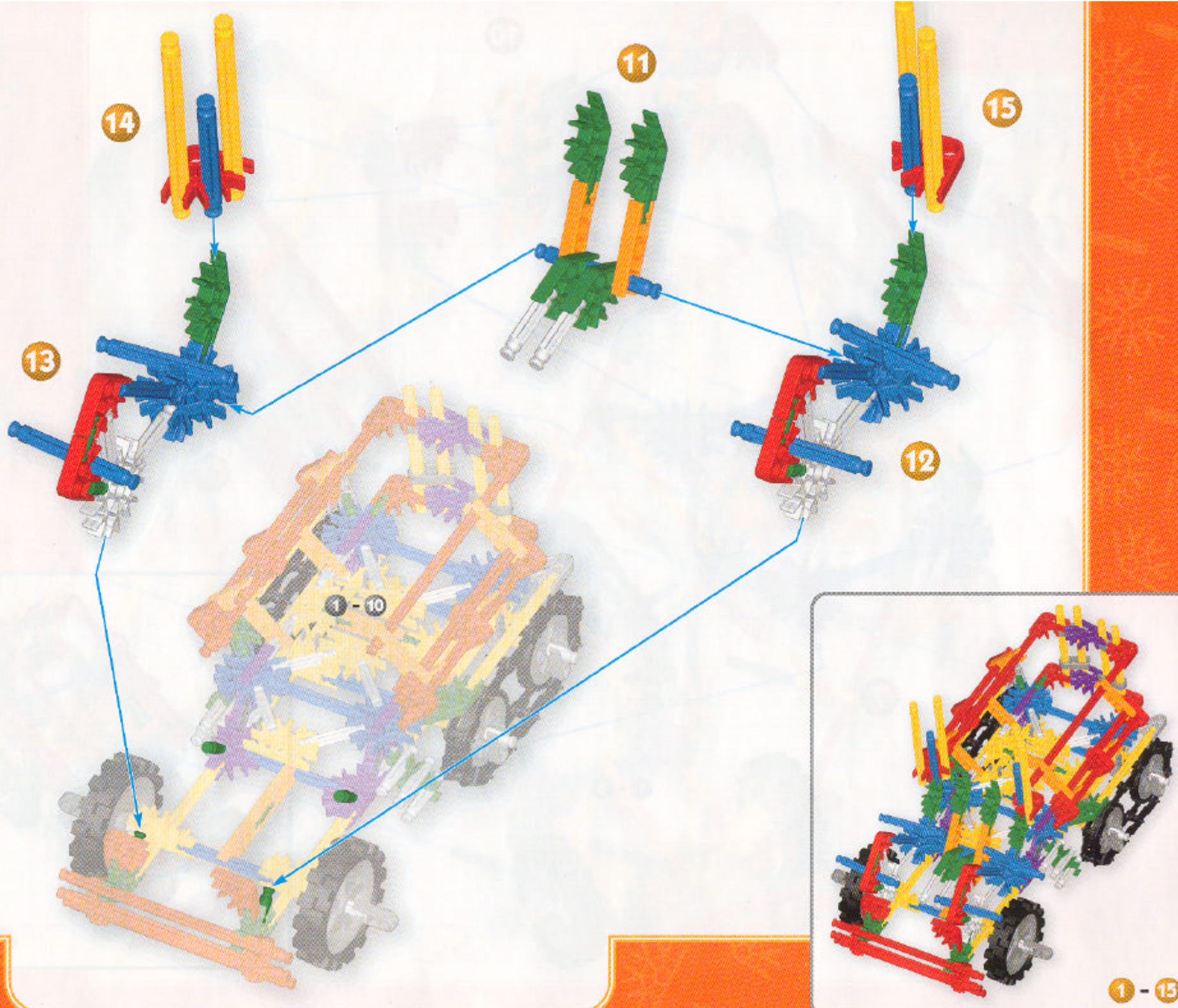

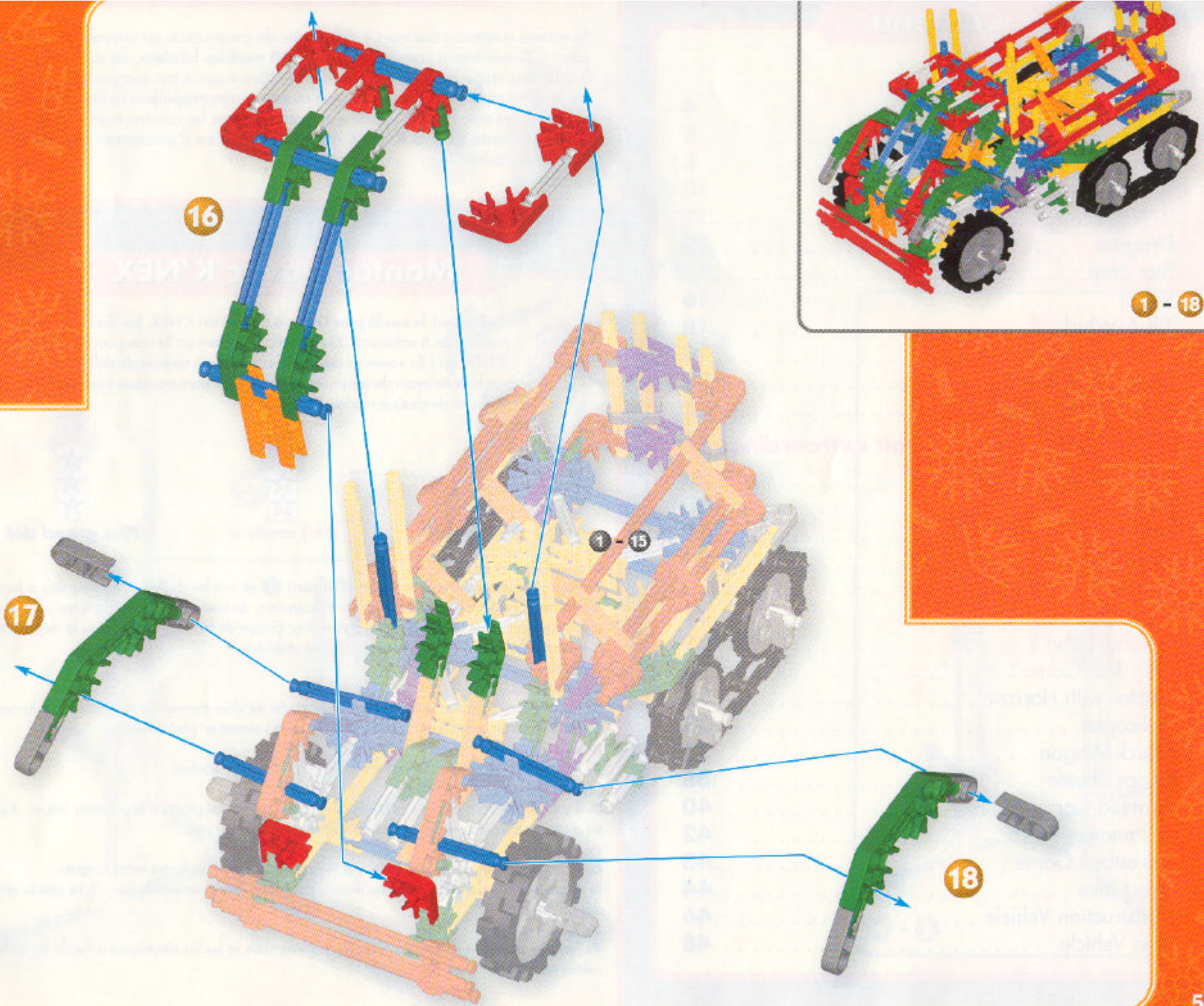

Modèles motorisés !

Sand Racer	4
Windmill	5
Wind-Up Ferris Wheel	8
Turbo Racer	10
3-Wheeler	11
Dragster	12
Star Ship	14
Robot	16
Tilt-A-Whirl	18
Eggbeater Ride	20
Space Ship Ride	22
Grandfather Clock	25

D'autres modèles tout à fait extraordinaires

Turtle	28
Castle	28
Sailboat	29
Ocean Liner	29
Fish	30
Picture Frame 1	31
Picture Frame 2	32
Ring Toss Game	33
Tractor with Harrow	34
Helicopter	35
Chuck Wagon	36
Space Shuttle	38
Formula Car	40
Catamaran	42
Basketball Game	43
Sport Bike	44
Construction Vehicle	46
Boss Vehicle	48

Tu adores construire des trucs ? Cette boîte de construction est vraiment pour toi alors ! Donne-t-en à cœur joie avec les **30** modèles fabuleux, en suivant les instructions étape par étape, ou bien laisse libre cours à ton imagination, et invente tes propres modèles ! Il y a même un moteur à rétropropulsion qui te permettra de motoriser tes créations ! Il y a de quoi satisfaire tous les constructeurs, des débutants aux K'NEXperts ! Avec le **K'NEX 425-PC TUB**, c'est d'amusement **DE TAILLE** dont nous parlons !

Montage avec K'NEX



1. Bonjour ! Je suis là pour t'aider à monter ton K'NEX. Les directives de ce livret vont t'aider à construire 30 modèles, te mettant sur la voie pour devenir un K'NEXpert ! Tu trouveras des modèles pour trois niveaux de difficulté. Cherche-moi sur la boîte avant de construire, je brandis un panneau pour t'indiquer le niveau de difficulté de chaque modèle... Regarde :



Défi amical



Défi modéré



Plus grand défi

Prépare-toi à construire

2. Pour commencer le modèle, trouve le numéro  et suis les chiffres. Chaque pièce a sa propre forme et couleur. Il suffit de regarder l'illustration, de trouver les pièces dans ton jeu qui correspondent à ce que tu vois et de les enclencher. Essaie de tenir le modèle dans le même sens que dans l'illustration. Ainsi, tes pièces seront attachées correctement.

Continuation

3. Les couleurs affaiblies indiquent que cette partie est déjà montée. Tu dois raccorder la nouvelle partie à l'endroit indiqué par les flèches. Ces pièces seront en pleine couleur.

Pièces d'écartement

4. Remontez jusqu'à ce que vous entendiez un clic. Puis, relâchez.

Pièces d'écartement

5. Il y a des endroits dans ton modèle où tu dois ajouter des pièces d'écartement bleues. Assure-toi d'utiliser la couleur exacte et de compter les pièces avec soin.

Connecteurs

6. Tu trouveras des connecteurs bleus et violets comportant des fentes extra-longues.

Ils se glissent l'un dans l'autre tel qu'illustré. Pousse les pièces ensemble jusqu'à ce que tu entendes un "clic".

Mise en garde :

7. Tenir les mains, le visage, les cheveux, les vêtements et les fils électriques à l'écart de toutes les pièces mobiles.

¡Modelos motorizados!

Sand Racer	4
Windmill	5
Wind-Up Ferris Wheel	8
Turbo Racer	10
3-Wheeler	11
Dragster	12
Star Ship	14
Robot	16
Tilt-A-Whirl	18
Eggbeater Ride	20
Space Ship Ride	22
Grandfather Clock	25

Más modelos extraordinarios

Turtle	28
Castle	28
Sailboat	29
Ocean Liner	29
Fish	30
Picture Frame 1	31
Picture Frame 2	32
Ring Toss Game	33
Tractor with Harrow	34
Helicopter	35
Chuck Wagon	36
Space Shuttle	38
Formula Car	40
Catamaran	42
Basketball Game	43
Sport Bike	44
Construction Vehicle	46
Boss Vehicle	48

¿Te gusta construir? ¡Este conjunto de construcción es especialmente para ti! Sigue, paso a paso, las instrucciones y podrás construir **30** asombrosos modelos, o usa tu imaginación para construir tus propias creaciones. ¡Hasta hay un motor a retropropulsión, para que tus creaciones tomen vida motorizada! Hay algo para cada uno, ¡desde principiantes hasta K'NEXperts! Vas a encontrar que construyendo con **K'NEX 425-PC TUB** tendrás una **GRAN** diversión.

Construcción con K'NEX



1. ¡Hola! Soy tu compañero en la construcción. Las instrucciones que ves en este libro te ayudarán a construir 30 modelos que te pondrán en camino de ser un K'NEXpert. Encontrarás modelos para tres niveles de construcción. Búscame antes de cada construcción, estaré sosteniendo un cartel que te dirá cuánto puede ser difícil.



Amigable desafío



Moderado desafío



Enorme desafío

Todo listo, comienza a construir

2. Para comenzar tu modelo, busca el **1** y sigue los números. Cada pieza tiene su propia forma y color. Simplemente mira los dibujos, busca las piezas correspondientes en tu juego y después conéctalas. Mientras construyes, trata de colocar tu modelo en la misma dirección que se muestra en las instrucciones.

Continúa

3. Los colores desteñidos muestran que esta sección ya está construida. Conecta las nuevas secciones en los lugares señalados por las flechas. Las nuevas piezas que agregues estarán en colores vivos.

Continúa

4. Da cuerda hasta escuchar un clic. Luego, suéltalo.

Espaciadores

5. Hay lugares en tu modelo donde tendrás que agregar Espaciadores azules. Cerciórate de usar el color correcto y cuéntalos con cuidado.

Conectores

6. Hay conectores azules y púrpura con ranuras largas especiales. Se enganchan deslizándose como ves en los dibujos. Conecta estas piezas empujándolas hasta que oigas "clic".

PRECAUCIÓN:

7. Mantener las manos, la cara, el cabello, la ropa y los cordones eléctricos alejados de todas las partes en movimiento.

Motorisierte Modelle!

Sand Racer	4
Windmill	5
Wind-Up Ferris Wheel	8
Turbo Racer	10
3-Wheeler	11
Dragster	12
Star Ship	14
Robot	16
Tilt-A-Whirl	18
Eggbeater Ride	20
Space Ship Ride	22
Grandfather Clock	25

Noch mehr raffinierte Modelle

Turtle	28
Castle	28
Sailboat	29
Ocean Liner	29
Fish	30
Picture Frame 1	31
Picture Frame 2	32
Ring Toss Game	33
Tractor with Harrow	34
Helicopter	35
Chuck Wagon	36
Space Shuttle	38
Formula Car	40
Catamaran	42
Basketball Game	43
Sport Bike	44
Construction Vehicle	46
Boss Vehicle	48

Wenn du gerne baust, ist dieser Bausatz ideal und genau das Richtige für dich! Dreißig tolle Modelle warten darauf, von dir gebaut zu werden. Befolge einfach die schrittweisen Anweisungen, oder lass dich von deiner Fantasie leiten und baue deine eigenen Kreationen! Und mit dem Aufziehmotor kannst du motorisierte Bewegung in deine Kreationen bringen! Hier gibt es etwas für jeden Geschmack und für jedes Niveau, vom Anfänger bis hin zu den K'NEXperts! Du wirst sehen -- mit **K'NEX 425-PC TUB** ist der Spaß am Bauen echt **MEGATOLL** -- garantiert!

Bauen mit K'NEX



1. Hallo, ich bin dein K'NEX-Bauhelfer. Die Anleitungen in diesem Heft helfen dir 30 Modelle zu bauen, damit du ein K'NEXperte werden kannst! Es gibt drei Schwierigkeitsstufen. Schau nach mir bevor du mit dem Bau eines Modells beginnst. Auf einem Schild zeige ich dir den Schwierigkeitsgrad für jedes Modell:



Einfach



Mittel



Schwieriger

Achtung - und los geht's

2. Um mit dem Bau deines Modells zu beginnen, suchst du zuerst das Teil mit der Nummer 1, dann das mit der Nummer 2 und so weiter. Jedes Teil hat eine bestimmte Form und Farbe. Schau einfach auf das Bild und suche dann die gleichen Teile in deinem Bausatz. Dann steckst du die Teile zusammen. Am besten ist es, wenn du die Teile im selben Winkel hältst, wie in der Abbildung, damit du sie an der richtigen Stelle anbringst.

Und weiter geht's

3. An den blassen Farben kannst du erkennen, welcher Teil bereits fertig ist. Das neue Teil gehört da hin, wo Pfeile hin zeigen. Dieser Teil ist in bunter Farbe.

Continúa

4. Aufziehen bis du ein Klicken hörst. Dann gibst du es frei.

Abstandsstücke

5. An bestimmten Stellen in deinem Modell musst du Abstandshalter, sogenannte Spacer, einbauen. Diese Abstandshalter sind blau. Achte darauf, dass du die richtige Farbe wählst und dass du die richtige Anzahl davon verwendest.

Verbindungsstücke

6. Blaue und purpurne Steckanschlüsse haben besonders lange Schlitzlöcher. Wie du auf der Abbildung sehen kannst, lassen sie sich ineinander schieben. Achte beim Aneinanderfügen dieser Teile darauf, dass du ein Klickgeräusch hörst. Erst dann sind die Teile fest miteinander verbunden.

Vorsicht:

7. Hände, Gesicht, Haare, Kleidung und Stromkabel von den sich bewegenden Teilen fernhalten.

Gemotorizeerde modellen!

Sand Racer	4
Windmill	5
Wind-Up Ferris Wheel	8
Turbo Racer	10
3-Wheeler	11
Dragster	12
Star Ship	14
Robot	16
Tilt-A-Whirl	18
Eggbeater Ride	20
Space Ship Ride	22
Grandfather Clock	25

Nog meer fantastische modellen

Turtle	28
Castle	28
Sailboat	29
Ocean Liner	29
Fish	30
Picture Frame 1	31
Picture Frame 2	32
Ring Toss Game	33
Tractor with Harrow	34
Helicopter	35
Chuck Wagon	36
Space Shuttle	38
Formula Car	40
Catamaran	42
Basketball Game	43
Sport Bike	44
Construction Vehicle	46
Boss Vehicle	48

Hou je van bouwen? Dit bouwgeheel is speciaal voor jou bestemd! Hier kan je kiezen tussen **30** fantastische modellen door gebruik te maken van deze geleidelijke instructies of gebruik je verbeelding om je eigen creaties te bouwen! Er is zelfs een motor met trek-actie om je creaties tot leven te brengen! Er is iets voor iedereen, van beginners tot K'NEXperts! Met de **K'NEX 425-PC TUB** heb je zeker **VEEL** bouwgenot!

Bouwen met K'NEX



1. Hoi! Ik ben je K'NEX bouwvriend. De aanwijzingen in dit boekje zullen je helpen met 30 modellen te bouwen en om je op weg te brengen om een K'NEXpert te worden! Je vindt modellen voor drie bouwpeilen. Voor je begint te bouwen, kijk even naar me uit met mijn kenteken om je aan te tonen hoe moeilijk elk model zal zijn ... kijk maar:



Niet moeilijk



Nogal moeilijk



Zeker moeilijk

Klaar - Bouwen maar

2. Om met je model te beginnen, zoek naar **1** en volg de nummers. Elk onderdeel heeft dezelfde vorm en kleur. Kijk gewoonweg naar de afbeelding, vind in je geheel de stukken die overeenstemmen met wat je ziet en druk ze in mekaar. Tracht je model in dezelfde richting te behouden als op de afbeelding zodat je de stukken op de juiste plaats zult vastmaken.

Verder ...

3. De vage kleuren duiden aan dat dit gedeelte reeds opgebouwd is. Het nieuwe deel moet aangebracht worden op de plaats waarop de peilen gericht zijn. Dit stuk zal in volle kleur aangevoeld zijn.

Continúa

4. Opwinden tot je een klik hoort. Dan loslaten.

Tussenstukken

5. In je model zijn er plaatsen waar blauwe tussenstukken moeten toegevoegd worden. Verzeker je ervan de juiste kleur te gebruiken en tel ze zorgvuldig.

Koppelstukken

6. Er zijn blauwe en purper koppelstukken met speciale lange gleuven. Ze schuiven in mekaar zoals je kunt zien op de afbeeldingen. Duw deze onderdelen in mekaar tot je een "klik" hoort.

OPGEPAST:

7. Hou handen, gezicht, haar, kleding en elektriciteits snoeren verwijderd van alle draaiende onderdelen.

Models can be built one at a time.
K'NEX is a registered trademark of K'NEX Industries, Inc.

Manufactured under U.S. Patents: 5,061,219; 5,137,486; 5,199,919;
5,238,438; 5,346,420; 5,350,331; 5,368,514; 5,491,769; 5,493,707;
5,497,559; 5,518,435; D383,509; D388,475; D389,903; D391,843;
D391,921; D399,555.

Other U.S. and foreign patents pending.
Conforms to the Requirements of ASTM Standard Consumer
Safety Specification on Toy Safety, F963-96a.



Imprimé aux USA

Le produit et les couleurs peuvent varier.
La plupart des modèles peuvent être construits un à la fois.
K'NEX est une marque déposée de K'NEX Industries, Inc.

Fabriqué sous brevets américains 5,061,219; 5,137,486;
5,199,919; 5,238,438; 5,346,420; 5,350,331; 5,368,514;
5,491,769; 5,493,707; 5,497,559; 5,518,435; D383,509;
D388,475; D389,903; D391,843; D391,921; D399,555.

Autres brevets américains et étrangers en instance.
Conforme aux spécifications de sécurité du consommateur
sur la sécurité des jouets de la norme ASTM F963-96a.



US 1-800-KID-KNEX US/Canada only (English only)

GB 00800-22427276 UK/Ireland only

F E D NL 001-215-996-4823



**US Consumer Services
K'NEX Industries, Inc.
P.O. Box 700
Hatfield, PA 19440-0700**



**GB K'NEX
Newport Consumer Services
Hasbro UK Ltd., Caswell Way
Newport, Gwent NP9 0YH**



www.knex.com



email@knex.com



© 2003 K'NEX Industries, Inc.
P.O. Box 700
Hatfield, PA 19440-0700

93179-V1-12/02