

K'NEX

Works with Other Brands!

400

Ils fonctionnent avec les autres marques!



WARNING:
CHOKING HAZARD - Small parts.
Not for children under 3 years.

AVERTISSEMENT:
DANGER D'ÉTOUFFEMENT - Pièces de petite taille.
Ne pas donner aux enfants de moins de 3 ans.

©2010 K'NEX Limited Partnership Group
P.O. Box 700, Hatfield, PA 19440-0700
115024-V4-04/10

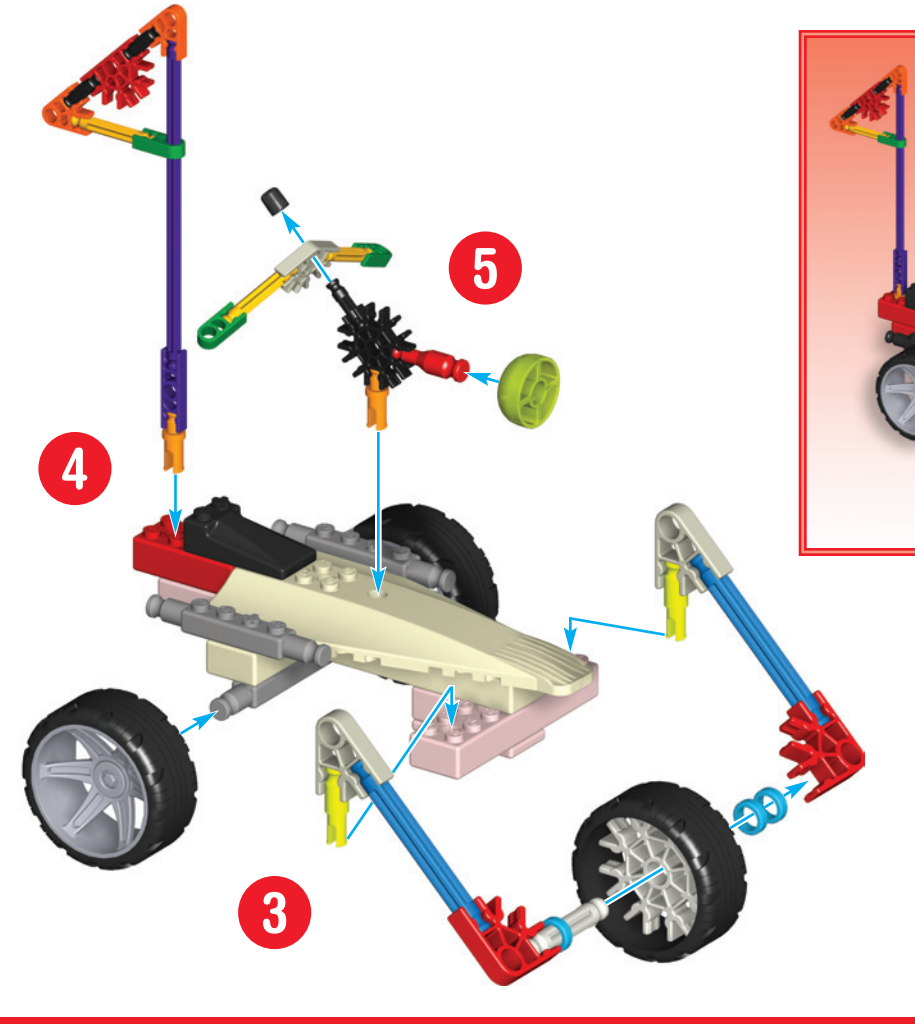
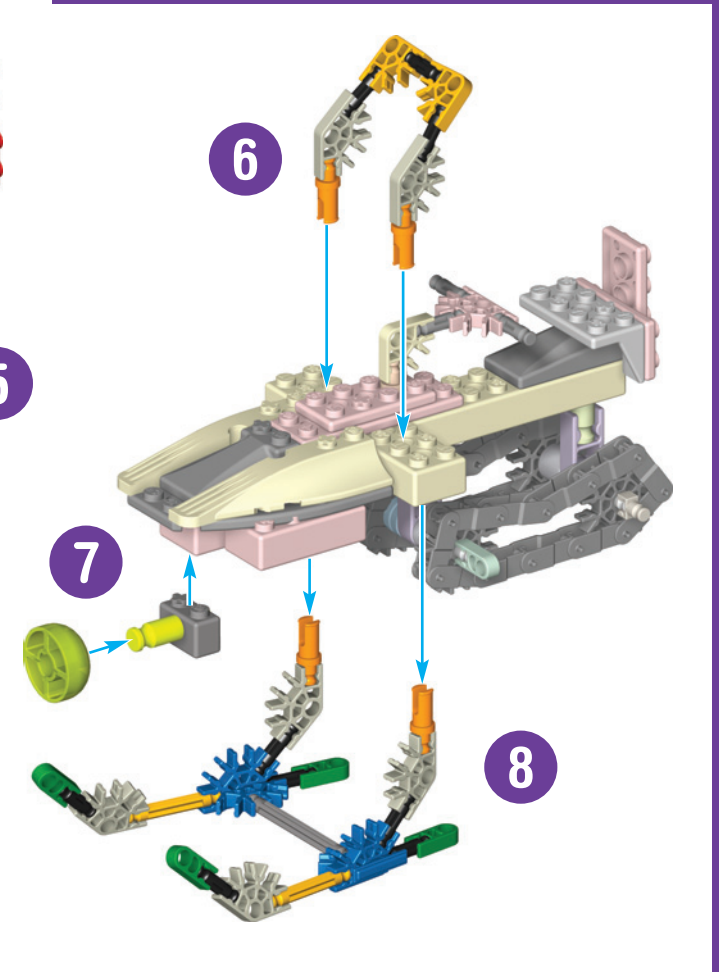
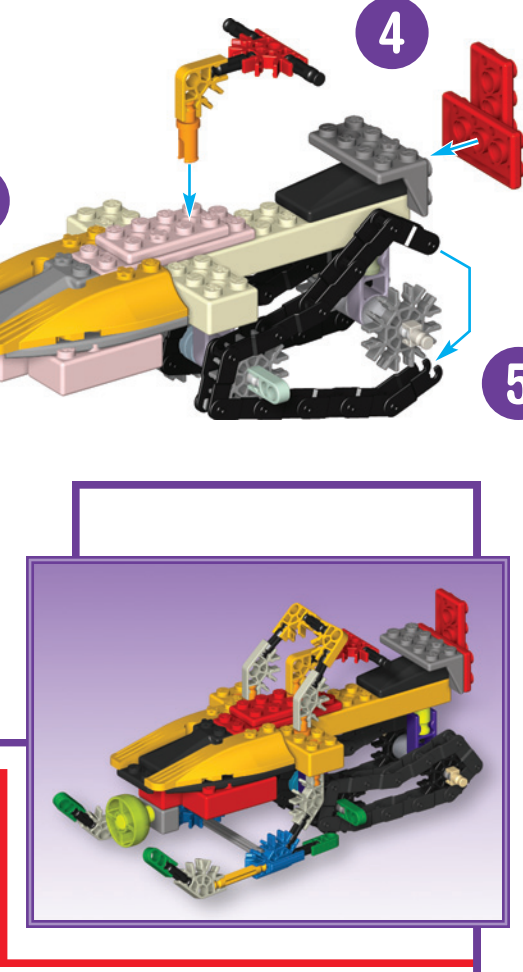
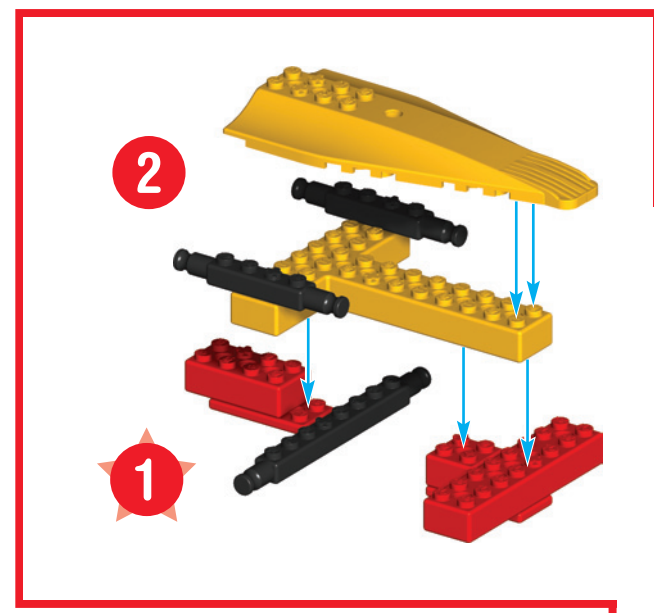
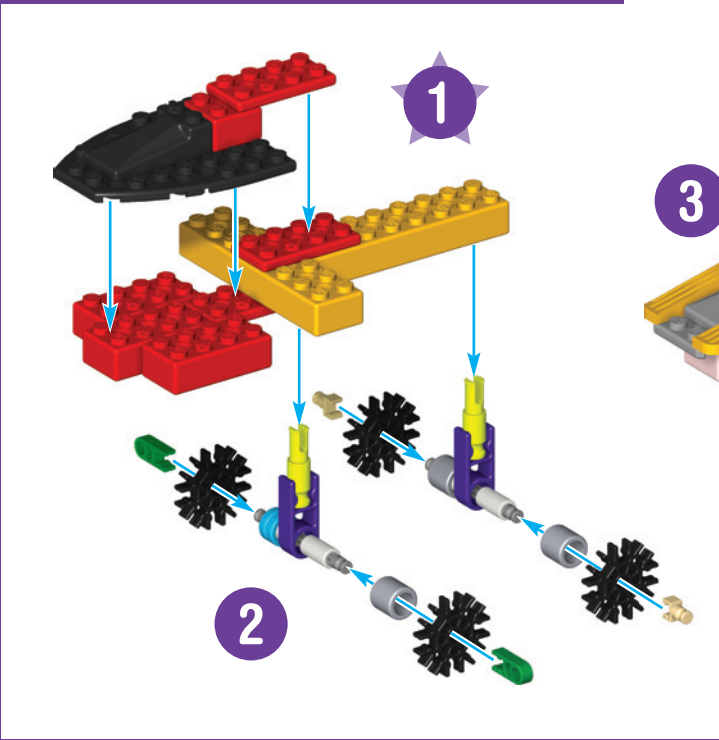
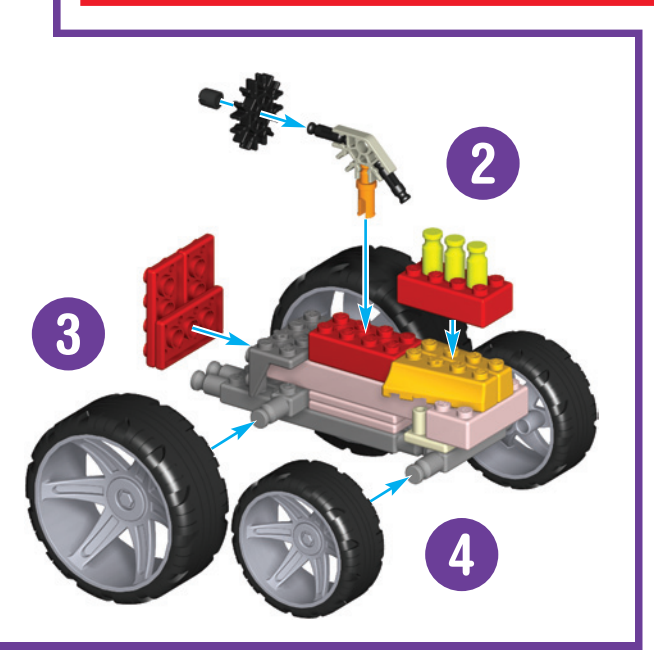
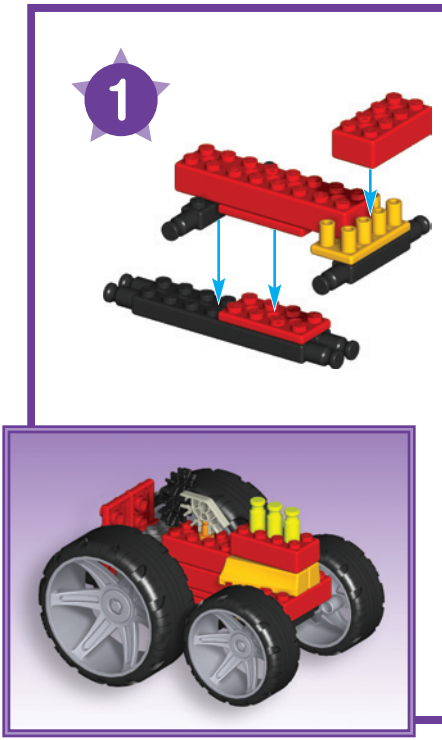
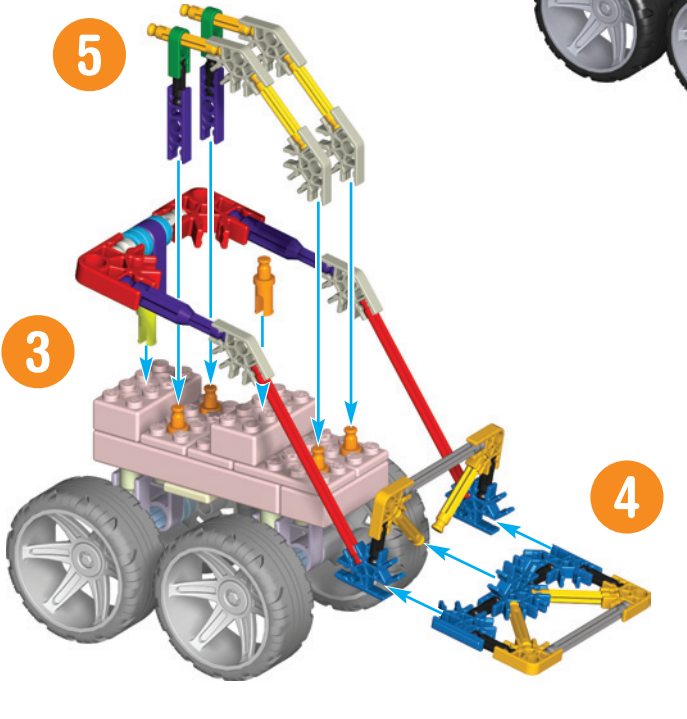
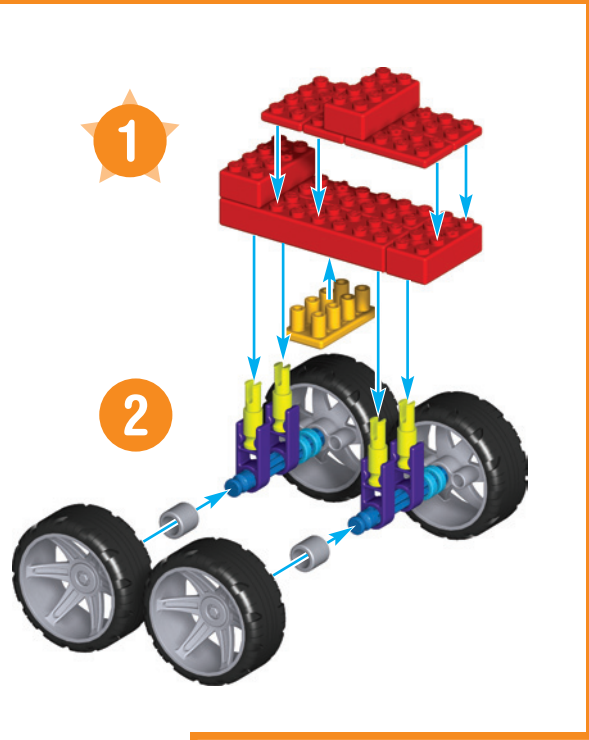

1-800-KID-KNEX (USA/États-Unis/Canada) • email@knex.com • knex.com
For Customer Service outside the USA, CAN, GBR please contact local distributor.
Distributor information can be found at: <http://www.knex.com/contact/international.php>
Product & colors may vary. K'NEX is a registered trademark of K'NEX Limited Partnership Group.
Le Service clients hors d'USA et CAN, s'il vous plaît contacter le distributeur local. L'information de distributeur peut être trouvée à <http://www.knex.com/contact/international.php>. Produits et couleurs peuvent varier. K'NEX est une marque déposée de K'NEX Limited Partnership Group.



K'NEX
Genuine K'NEX Bricks

- Identifies Genuine K'NEX Bricks.
- Identifie que ce sont d'authentiques briques K'NEX.
- Identifica los ladrillos genuinos de K'NEX.
- Identifiziert echte K'NEX-Bausteine.
- Identifica i veri blocchi K'NEX.
- Identifica que são cubos genuinos da K'NEX.
- Identificeert K'NEX bakstenen voor.



Visit www.knex.com/instructions and enter code 15024 to find instructions for these toy ideas.

Visite www.knex.com/instructions et entre le code 15024 pour trouver des instructions pour ces idées de jouet.

