

12036/48336



250+

PIECE / PIEZA

VALUE TUB

6-12 BUILDING SET
SYSTÈME DE CONSTRUCTION

Get more, See more, Do more!
Obtiens plus, Vois plus, Fais plus !



WARNING:

CHOKING HAZARD - Small parts.
Not for children under 3 years.



AVERTISSEMENT:

DANGER D'ÉTOUFFEMENT - Pièces de petite taille.
Ne pas donner aux enfants de moins de 3ans.

**IDEAS FOR
20 MODELS!**
DES IDÉES POUR 20 MODÈLES !

Contents

Welcome	2	Bunny	20
About the Set	2	Cake	21
Building with K'NEX	3	Jet	22
Models To Build		Rescue Axe	23
Mini Kart	4	Swing Ride	24
Mini Jet	4	Owl	25
Golf Cart	5	Beetle	26
Copter	6	Chinese Junk Boat	27
Race Car	7	Stunt Plane	28
Space Cruiser	8	Dragster	29
Super Bot	10	What's Included	30
Lawn Mower	11	ⓕ French Language	30
Clawing Lobster	12	ⓔ Spanish Language	31
Licking Lizard	17	ⓓ German Language	31
		Ⓝ Dutch Language	31



Welcome!

The fun is about to begin!

I designed the K'NEX building system for kids like you – kids who want to build in a whole new way. Using our snap-together Rods, Connectors and color-coded instructions, you can build the models we've designed – or you can use your imagination and build cool models of your own! That's what K'NEX is all about – getting an idea and making it happen. Just like I did when I invented K'NEX!

Joel Glickman
Inventor of K'NEX

CAUTION: Keep hair, fingers, face, and clothing away from all moving parts.

About the Set

Do you love to build? This building set is especially for you! Try your creative skills out with the amazing models shown in this book. Use the step-by-step instructions and ideas or use your imagination to build creations of your own! There's something for everyone, from beginners through K'NEXperts!

Building with K'NEX

Hi! I'm your K'NEX building buddy. You'll find models for three levels of building. Look for me before each build, holding up a sign to show you how difficult each model will be... check this out:



Friendly Challenge



Moderate Challenge

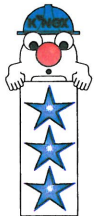

Greater Challenge

Ready, Set, Build

To begin your model, find the **1** and follow the numbers. Each piece has its own shape and color. Just look at the picture, find the pieces in

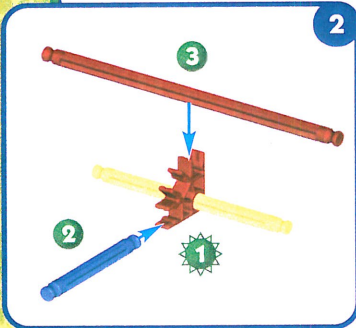

your set that match what you see, and snap them together. Try to hold your model in the same direction as in the picture so you'll attach your pieces to the right place.

Movin' On

The faded colors tell you this section is already built. You'll want to connect the new section to the place where the arrows are pointing. This piece will be in full color.

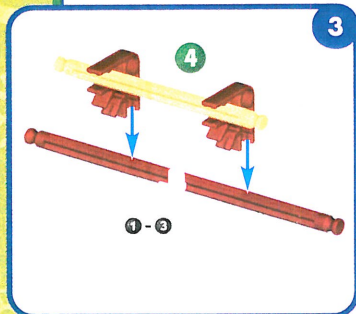

Spacers

There are places in your model where you need to add blue and silver Spacers. Be sure to count them carefully.

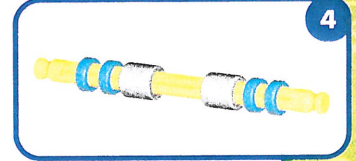

Connectors

It's very important to position blue and purple Connectors in a specific direction. Pay close attention to the instructions, and position these Connectors horizontally or vertically exactly as they are shown. Push together tightly until you hear a "click".

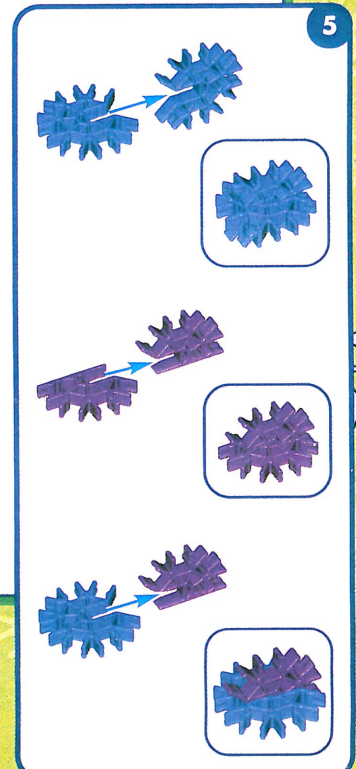



Mini Kart

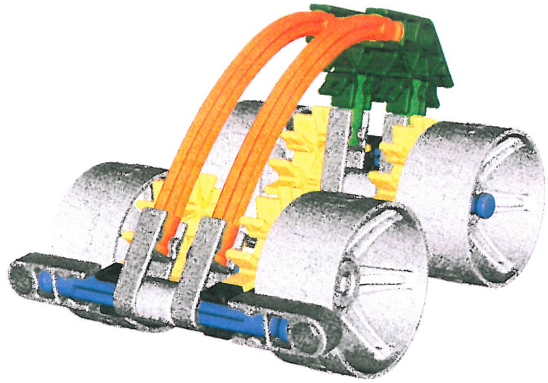

Mini Jet

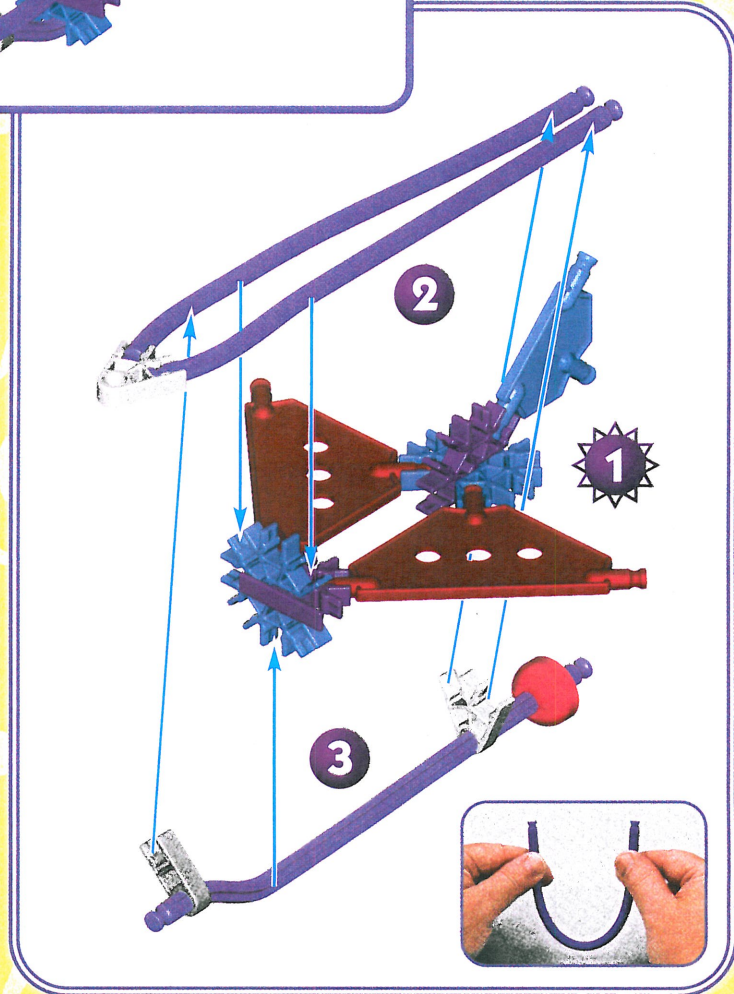
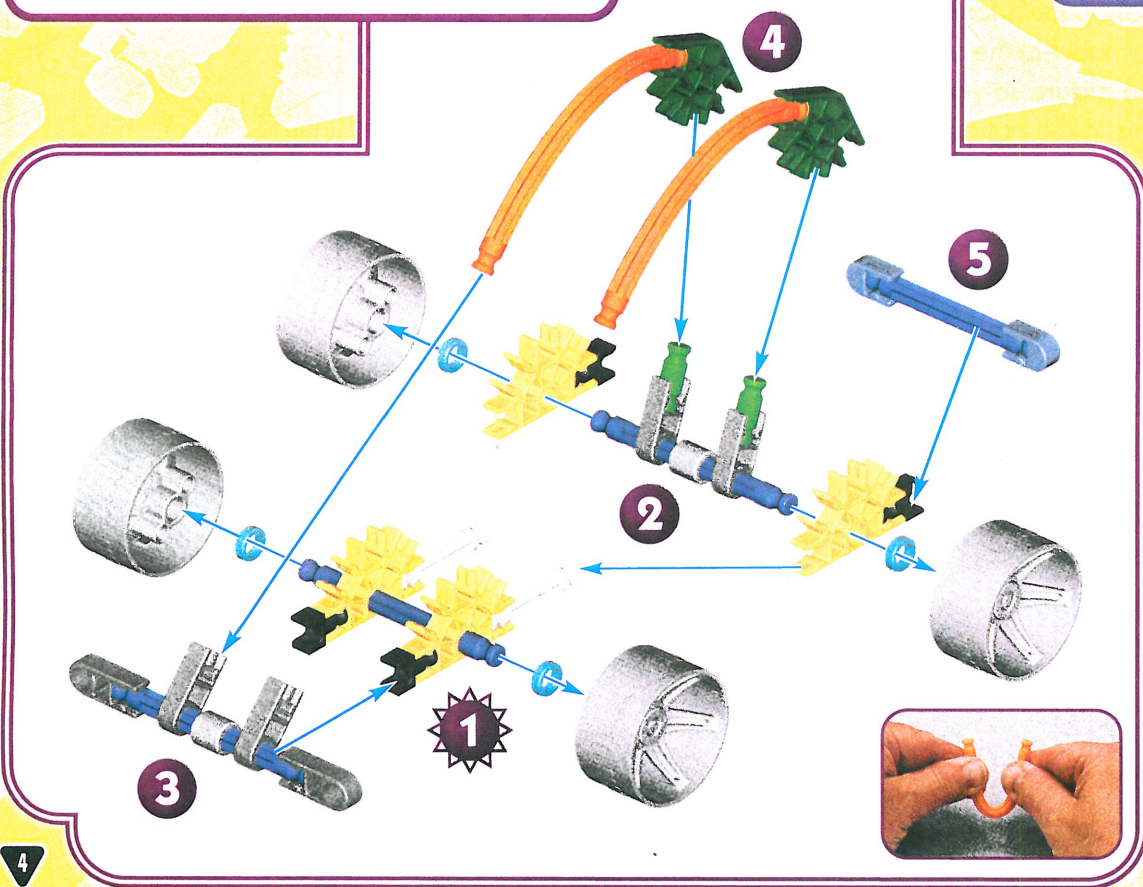
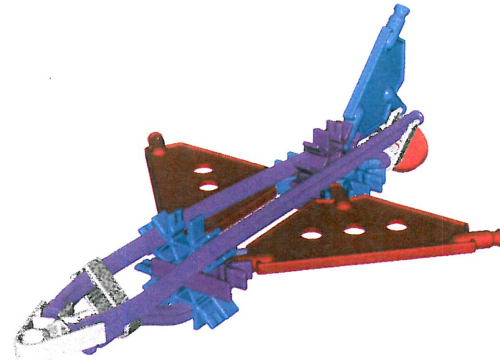



Golf Cart

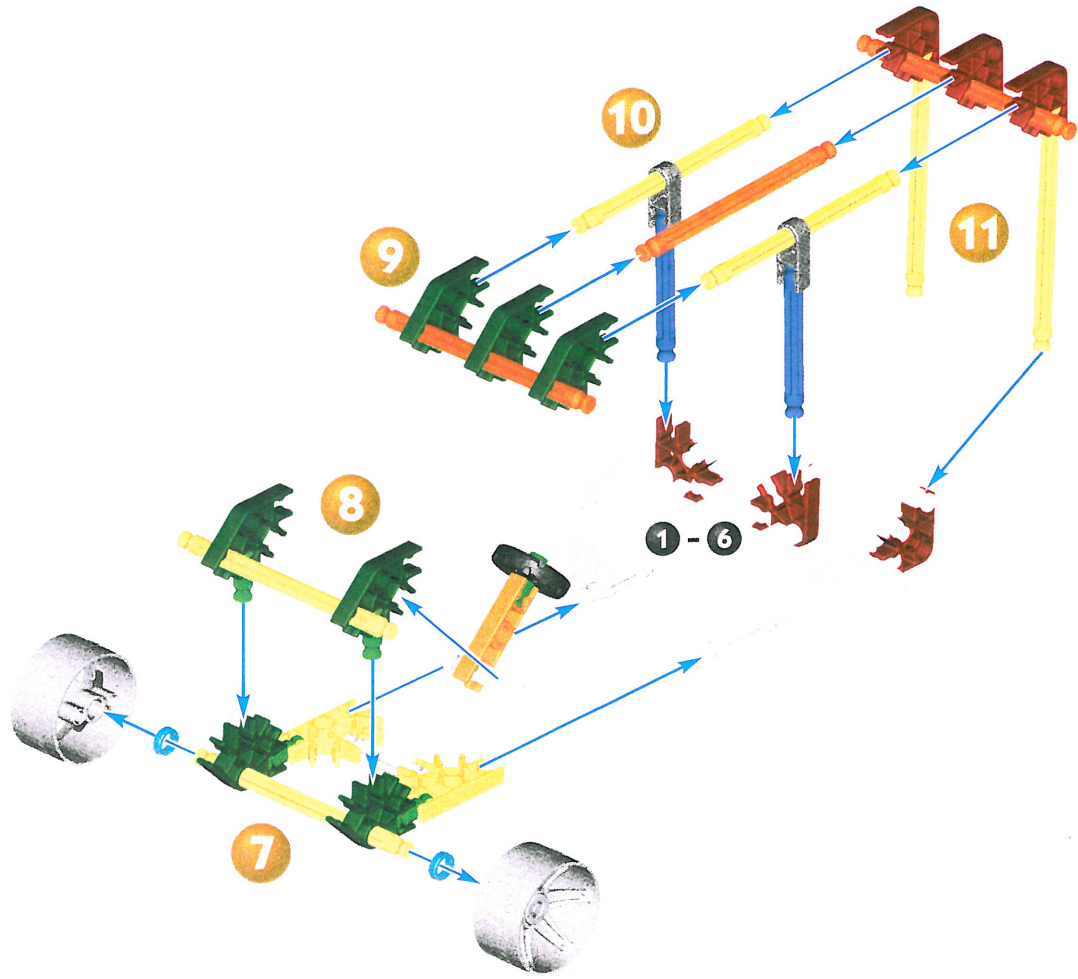
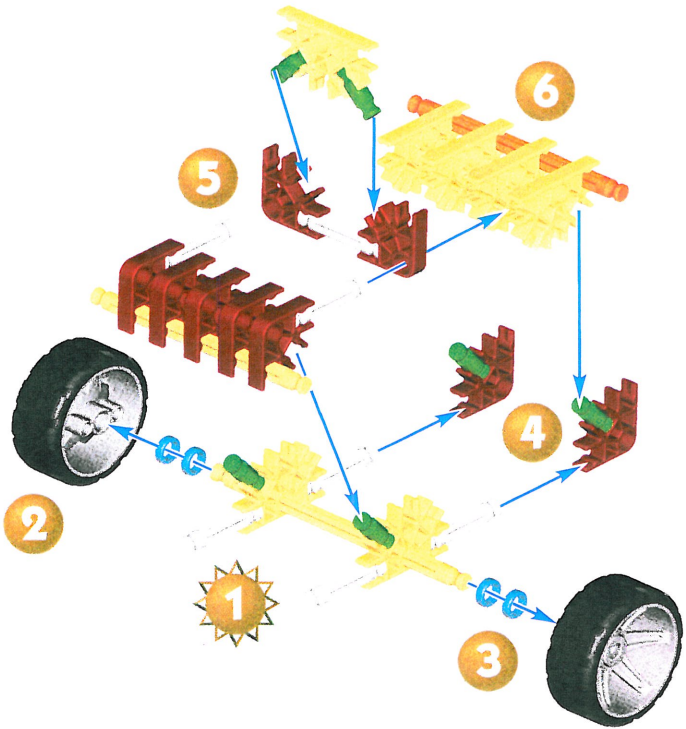
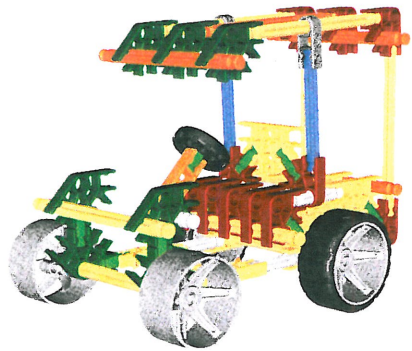



Copter

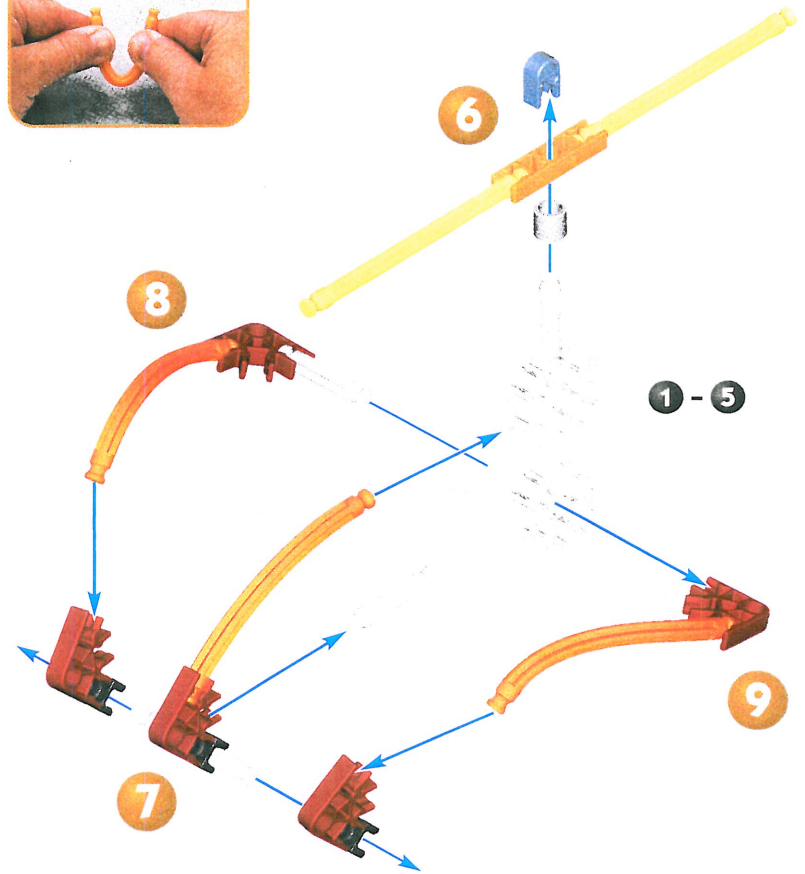
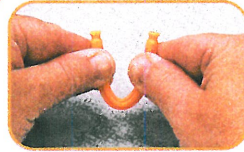
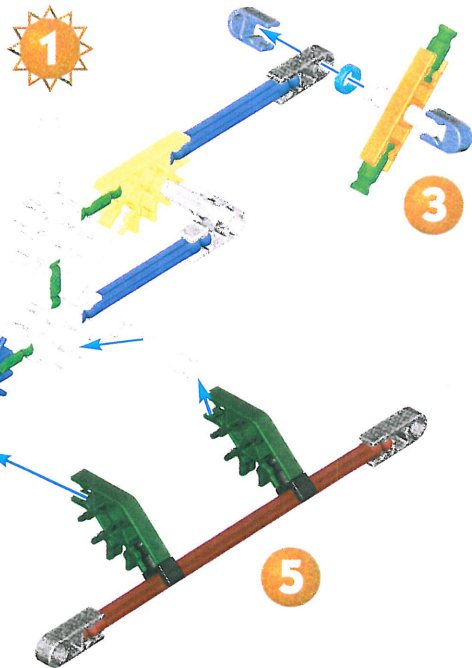
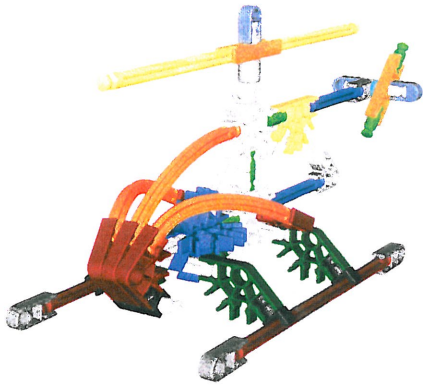



Race Car

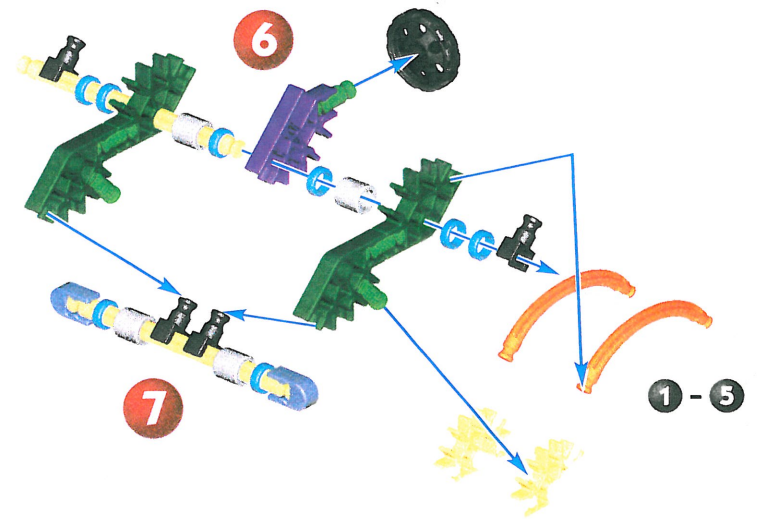
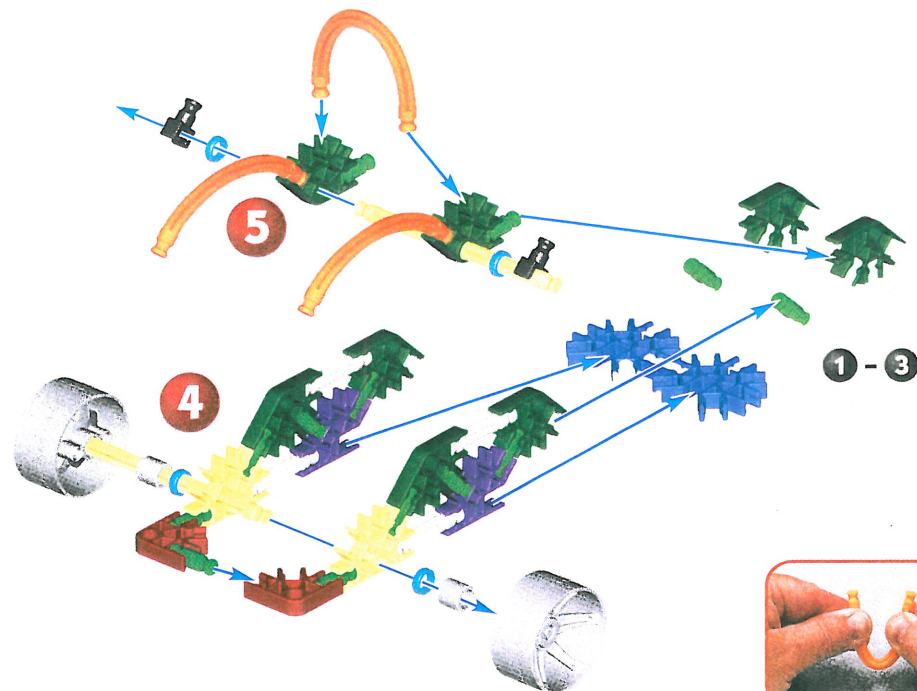
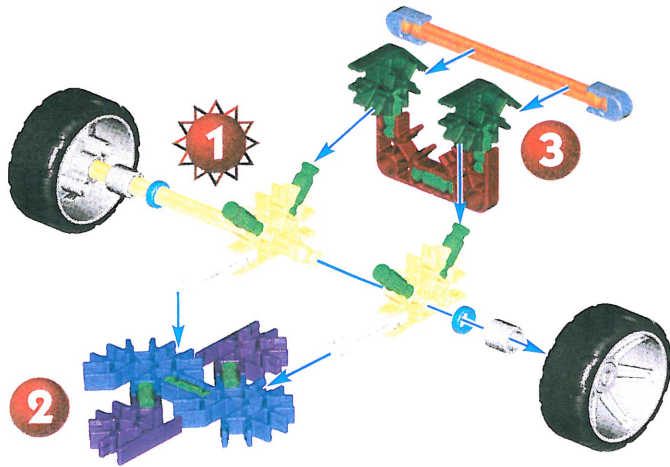
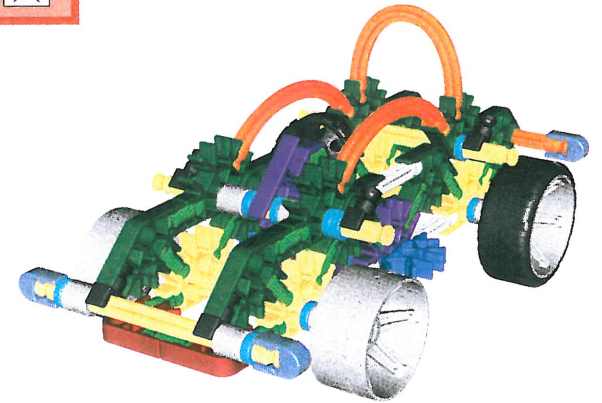



Space Cruiser

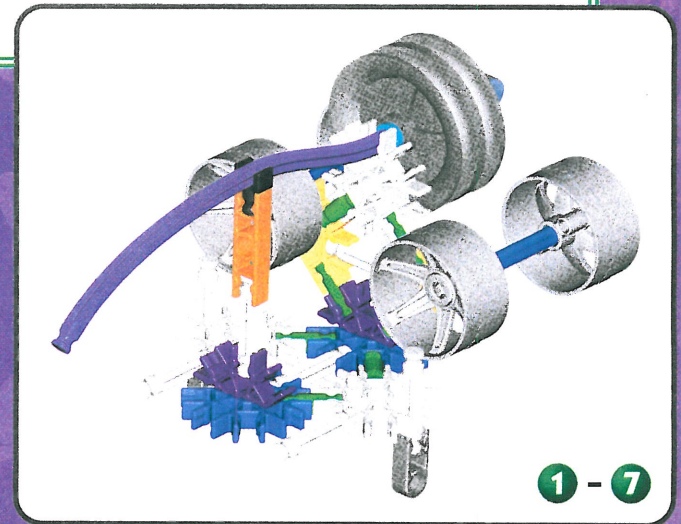
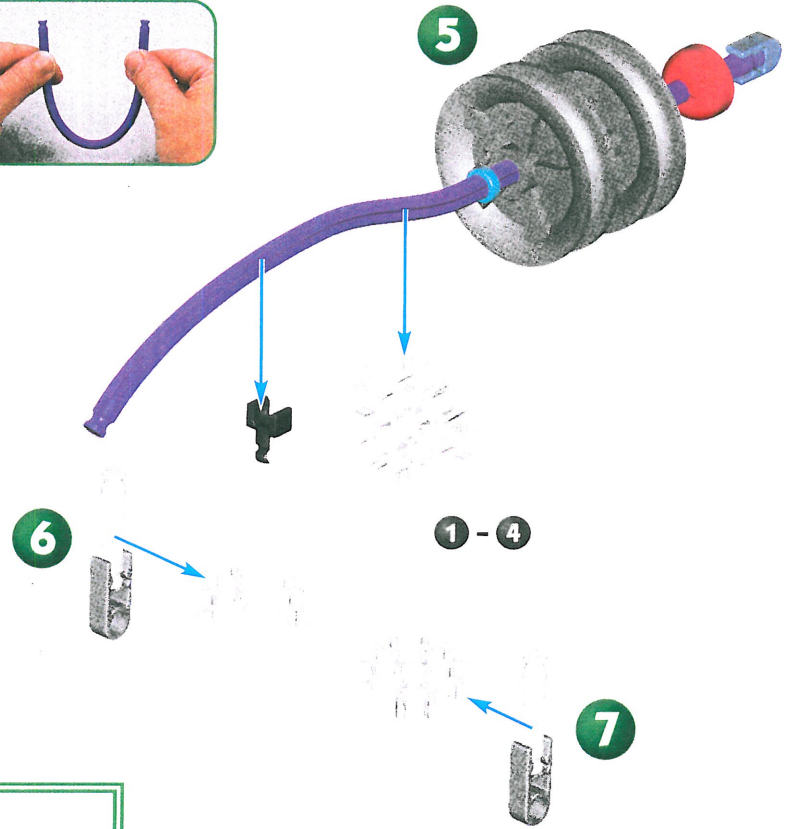
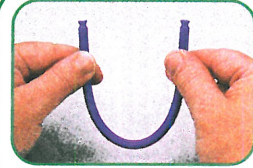
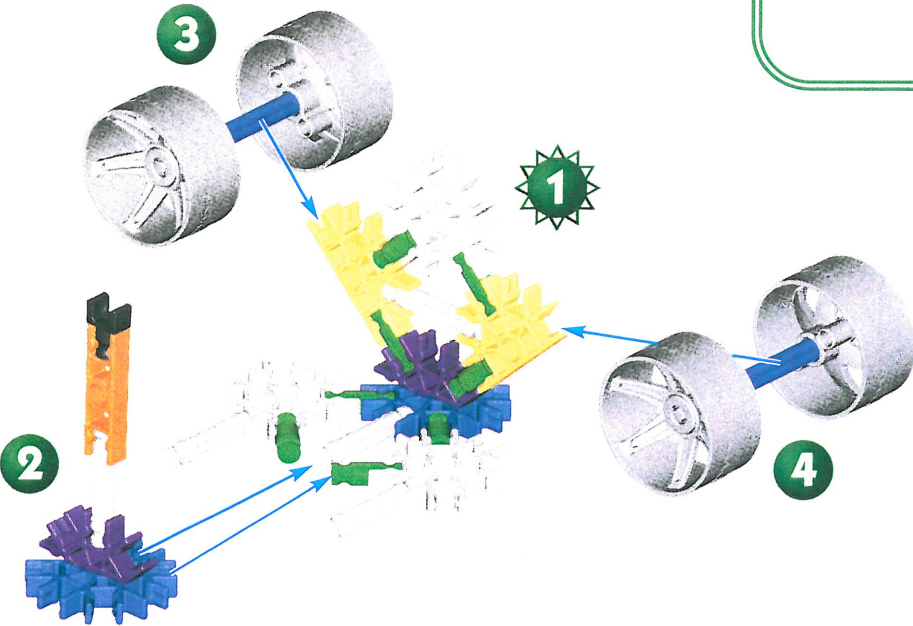
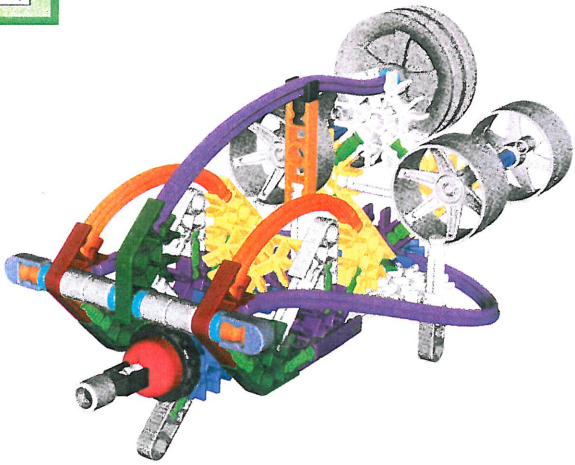

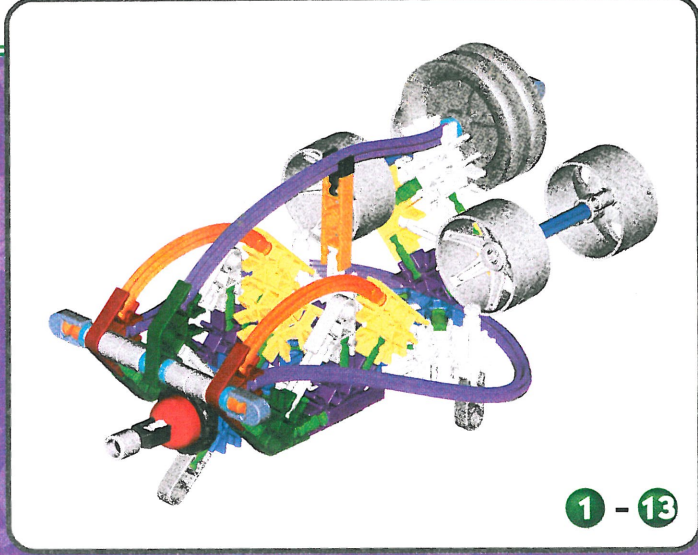
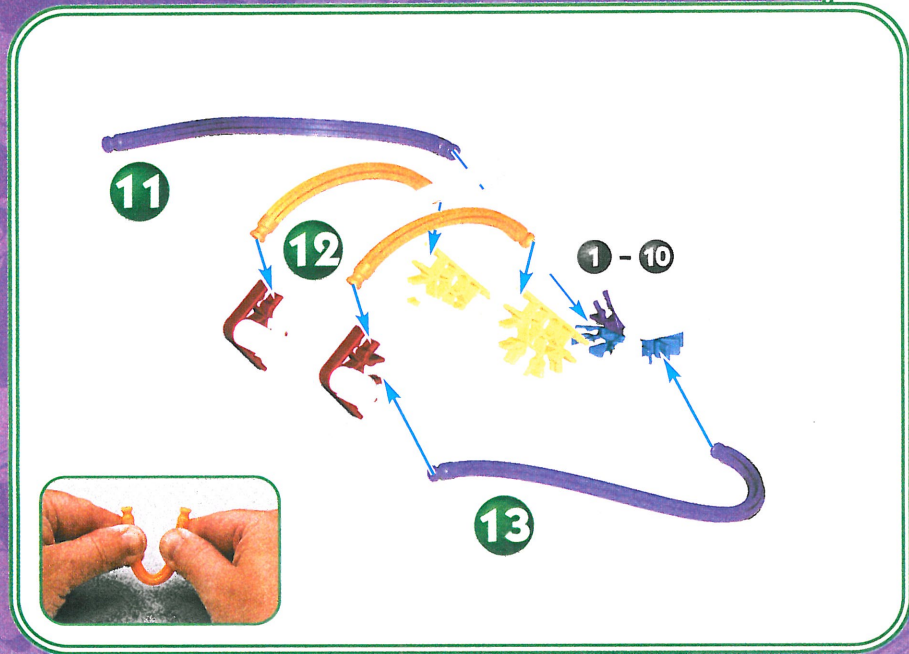
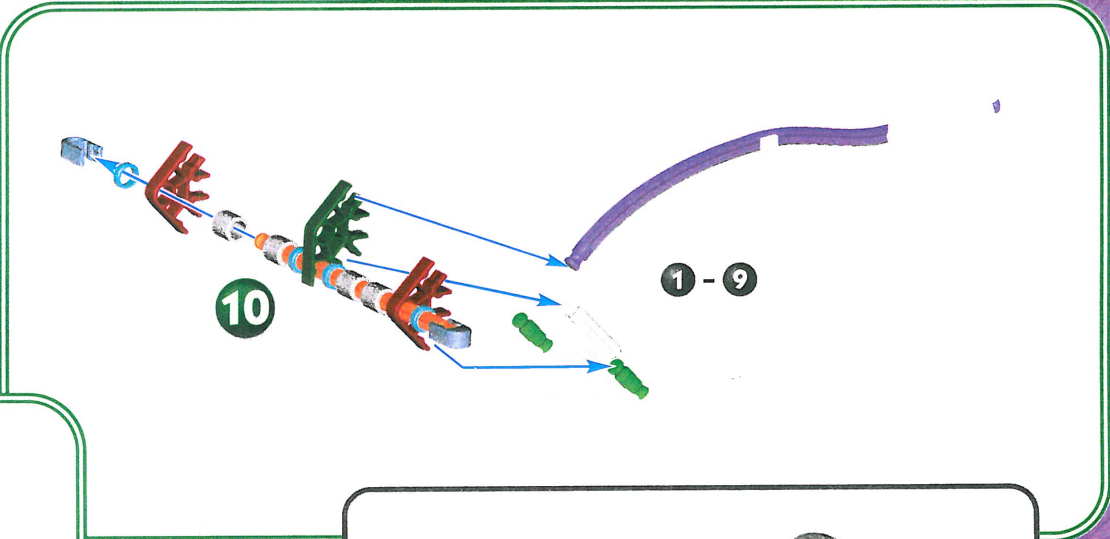
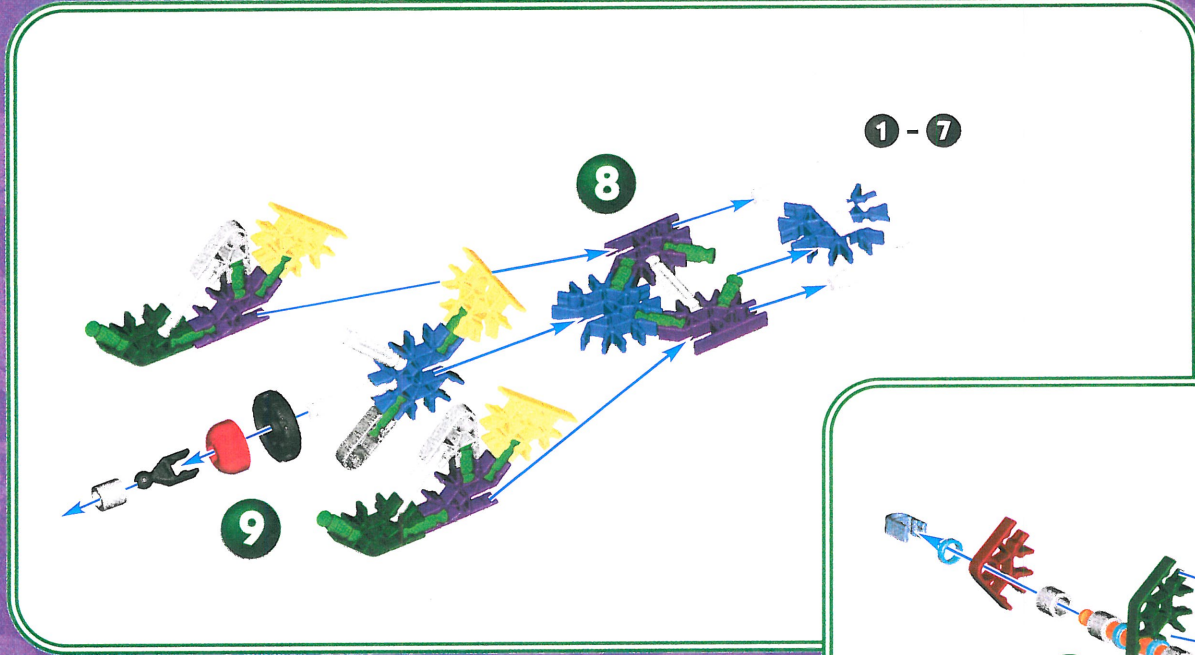



Super Bot

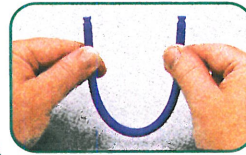
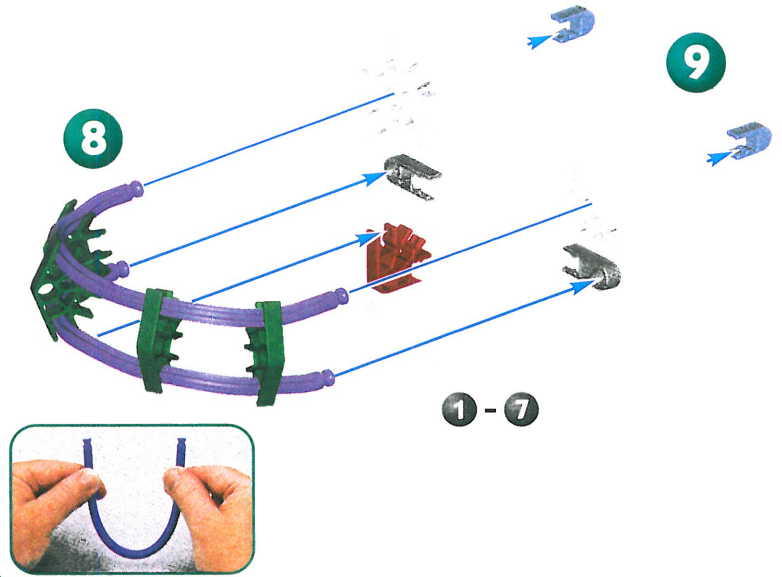
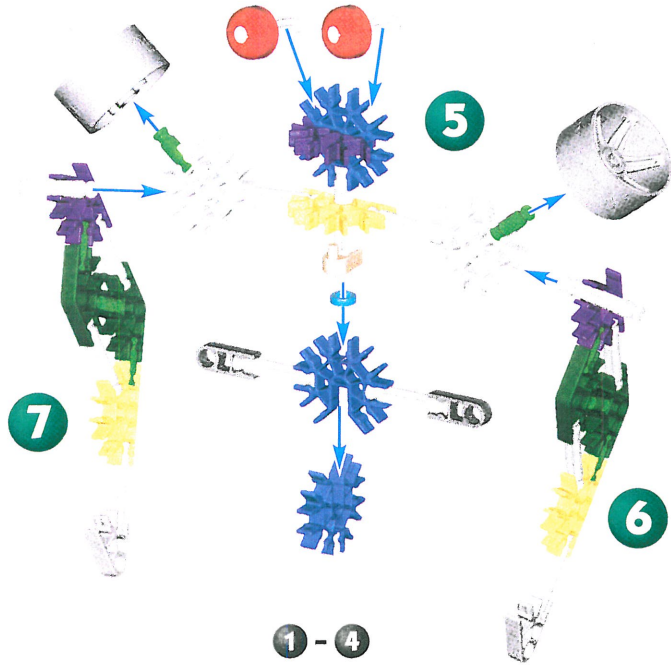
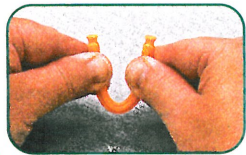
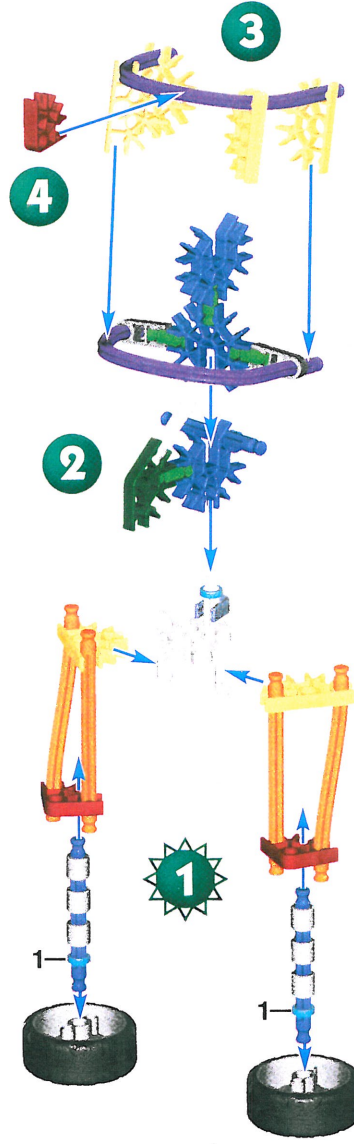
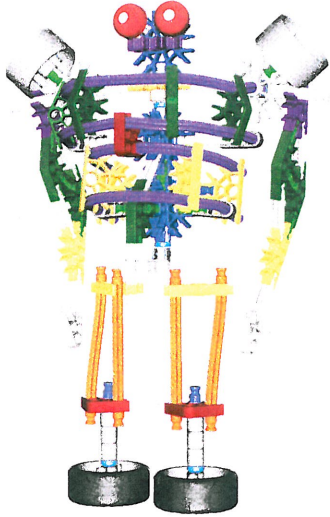



Lawn Mower

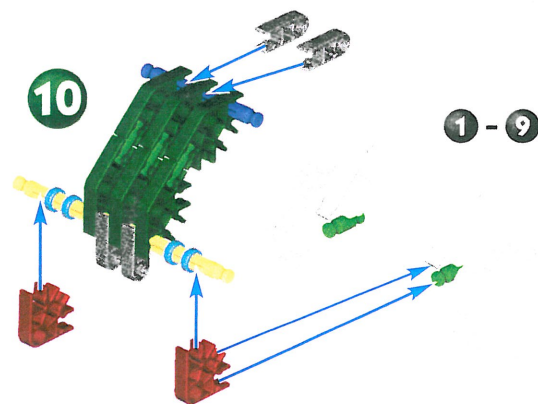
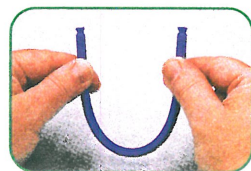
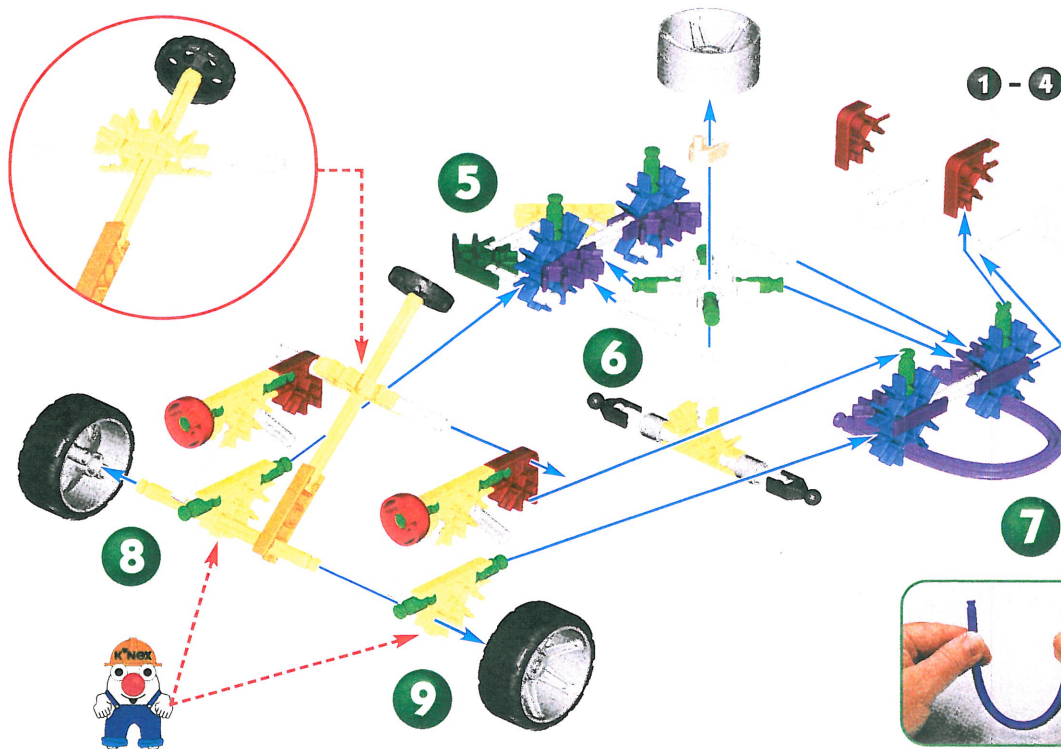
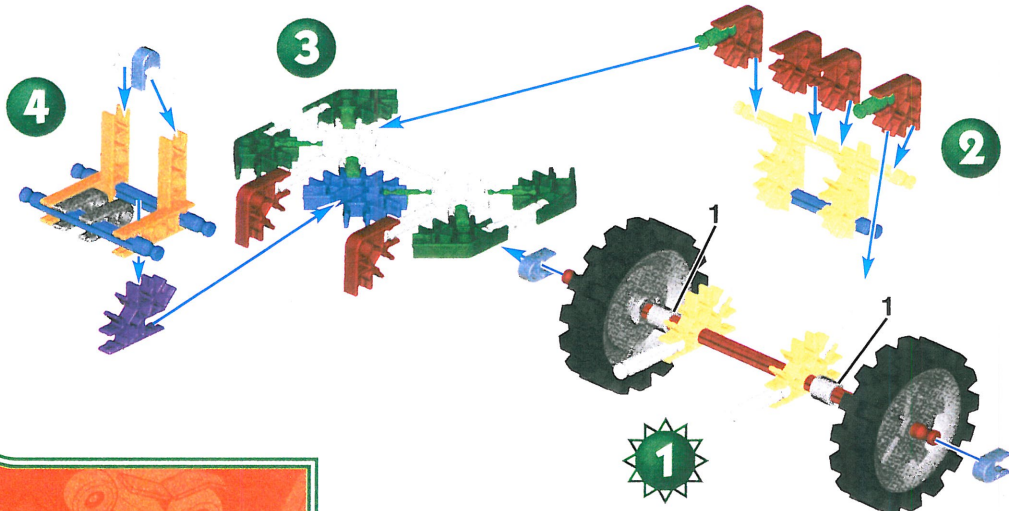
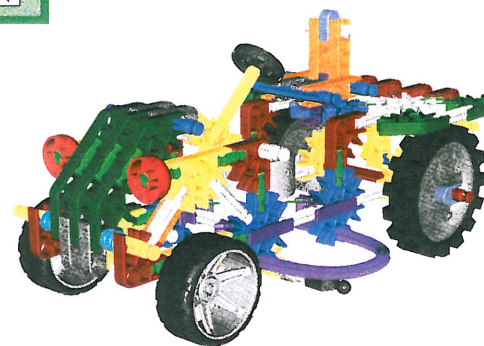



Clawing Lobster

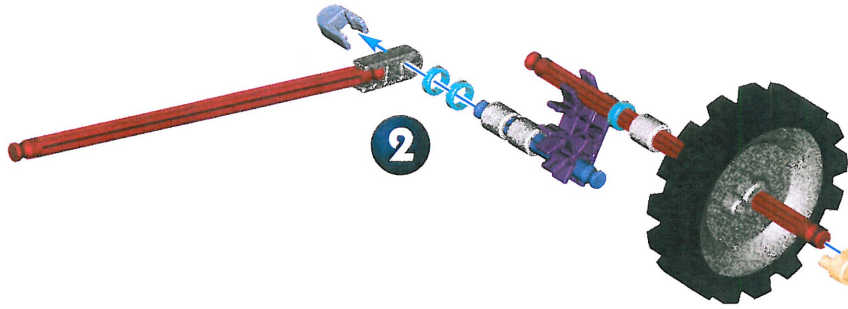
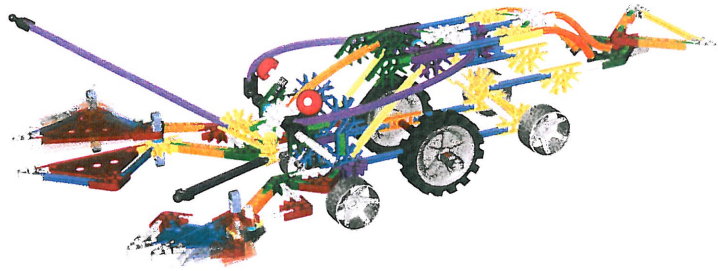

2

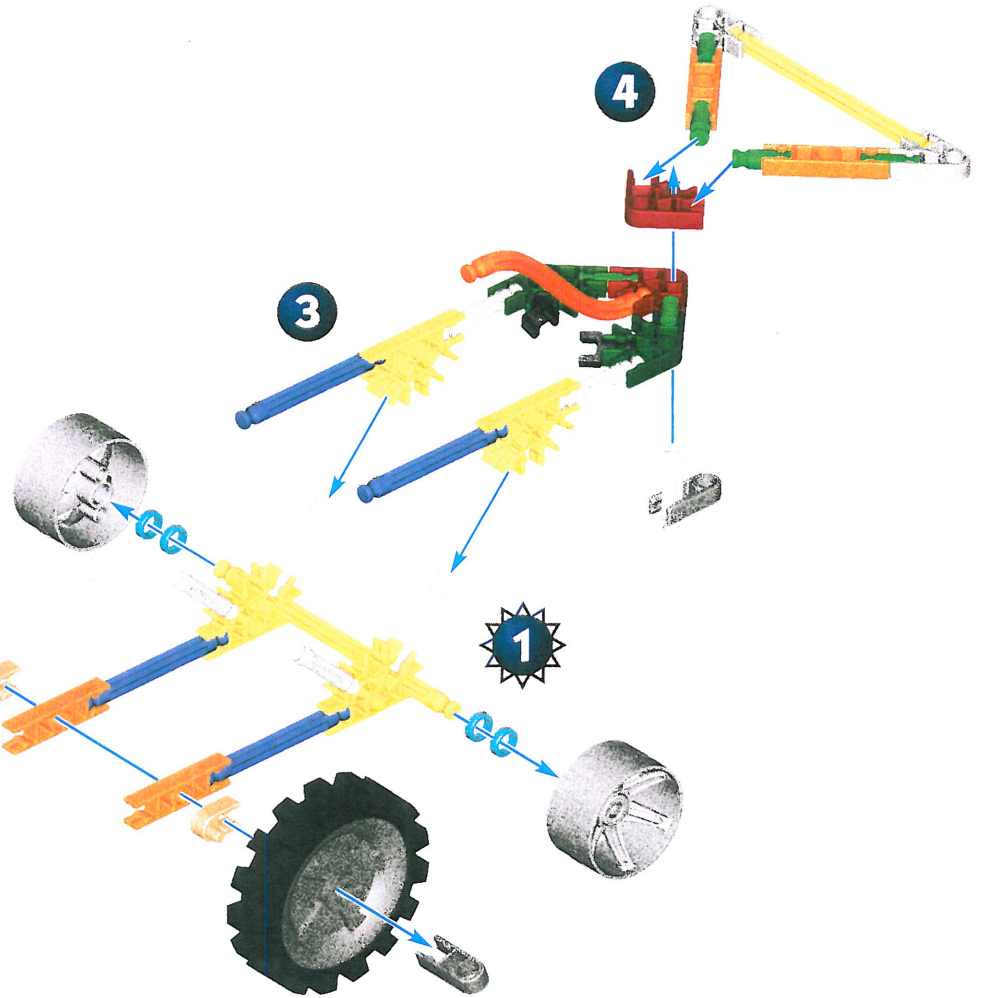

3

4

1

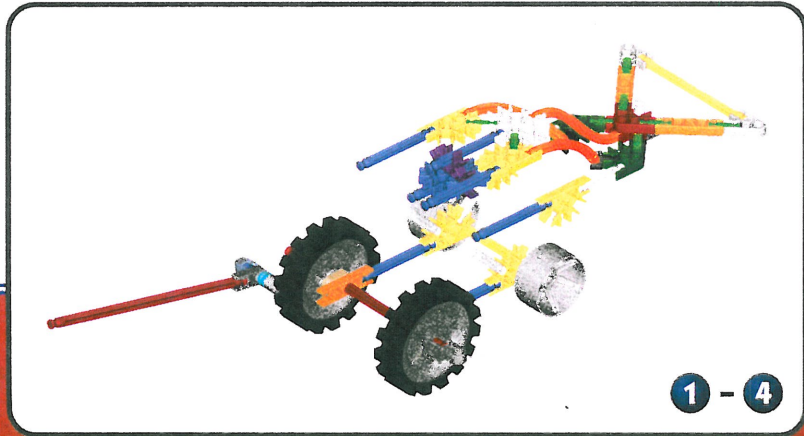

1 - 4

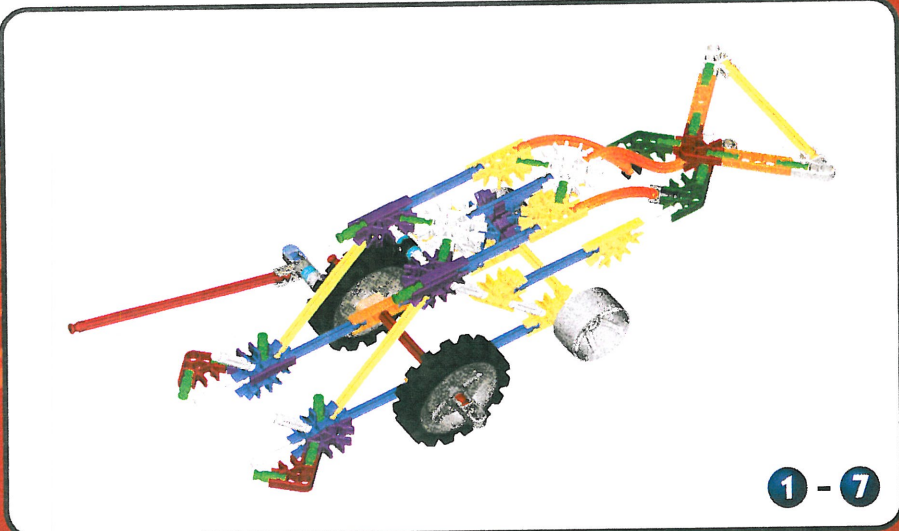
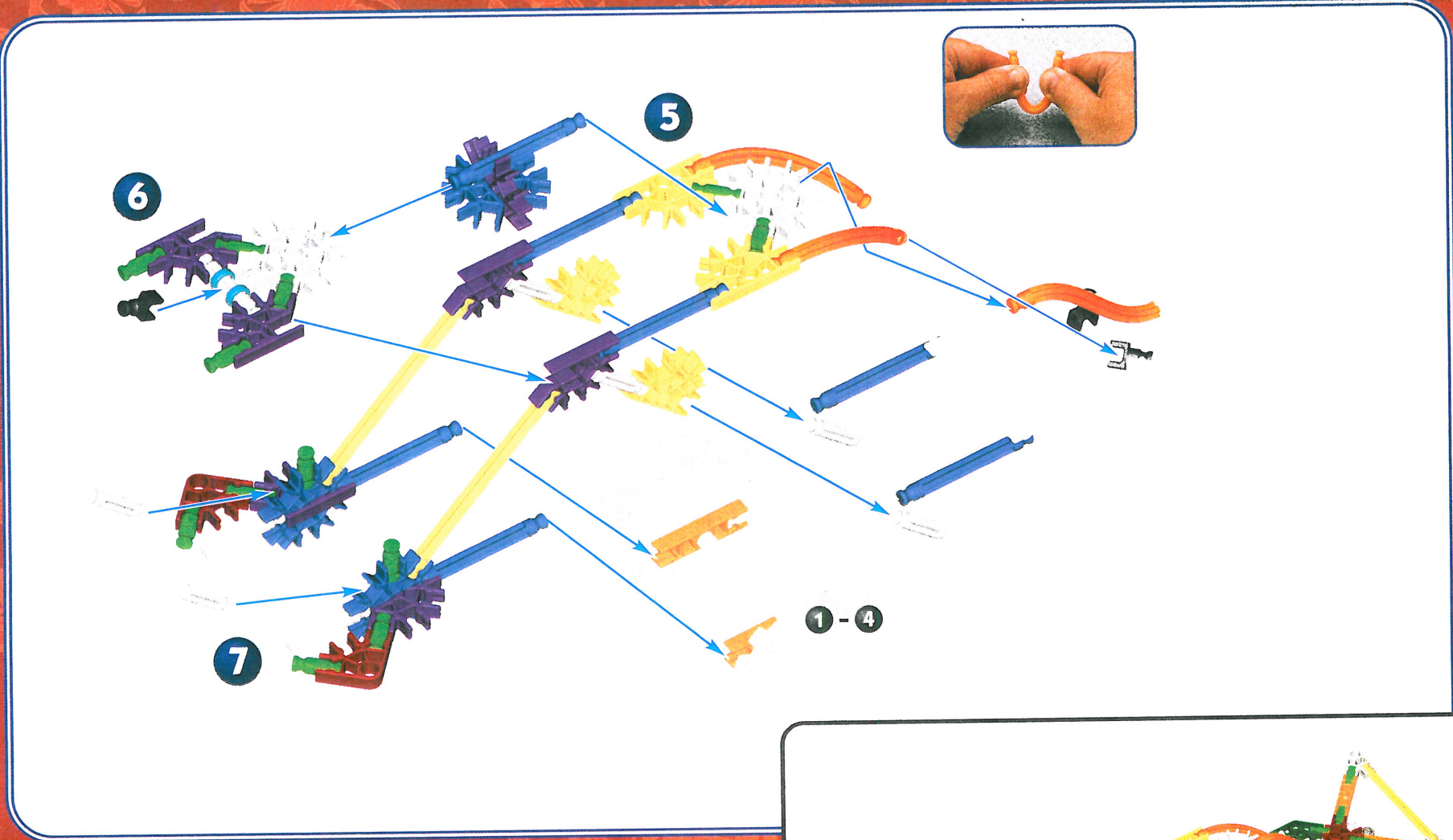

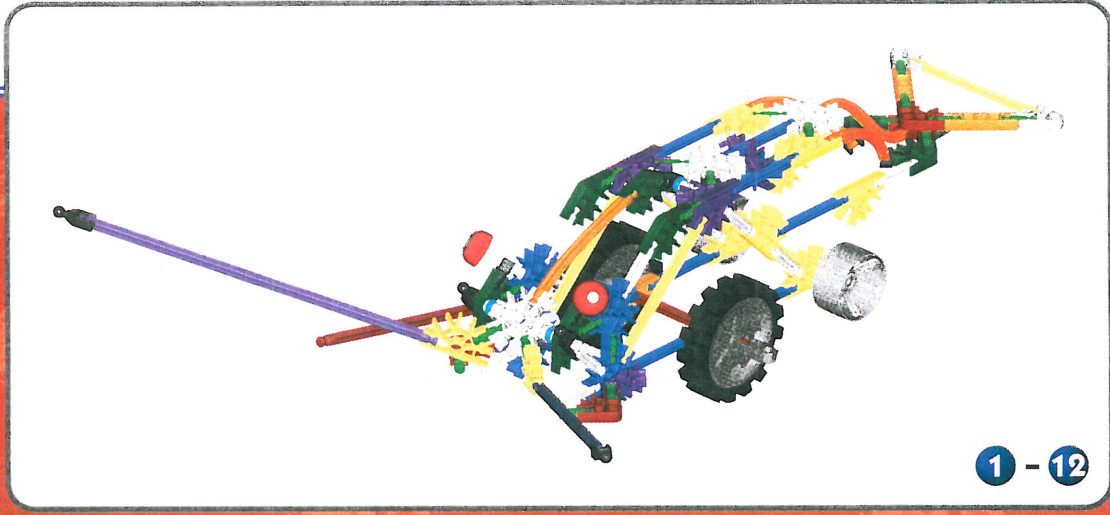
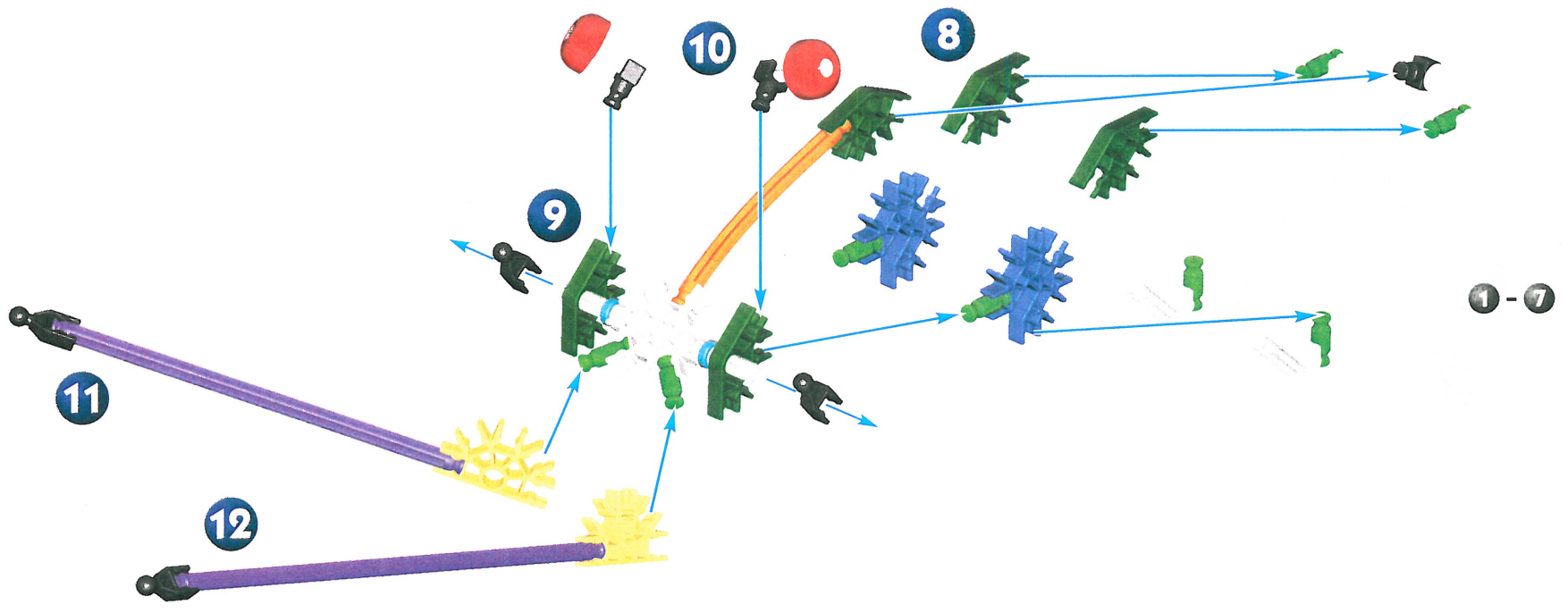

1 - 12

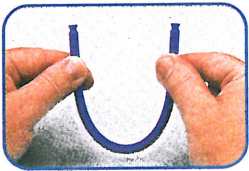

15

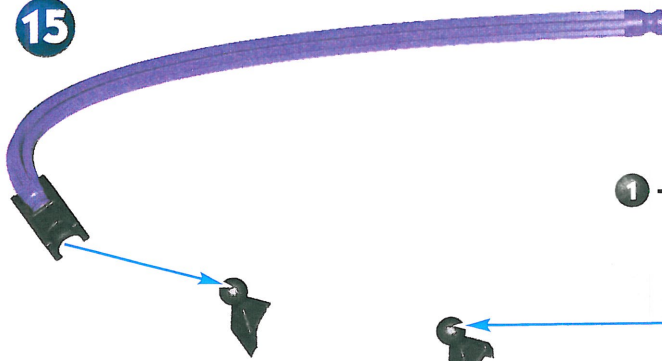

1 - 12

14

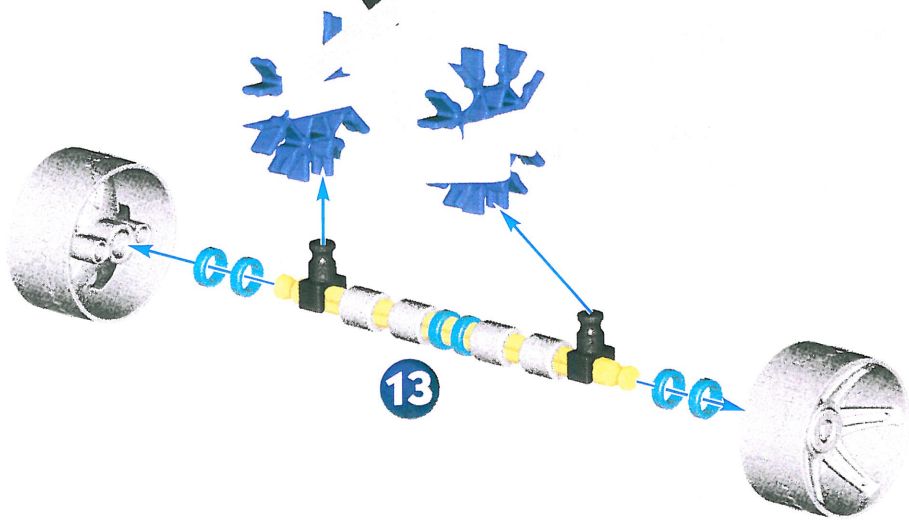
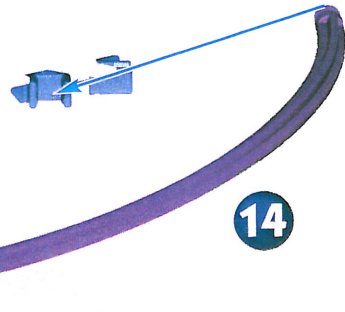

13

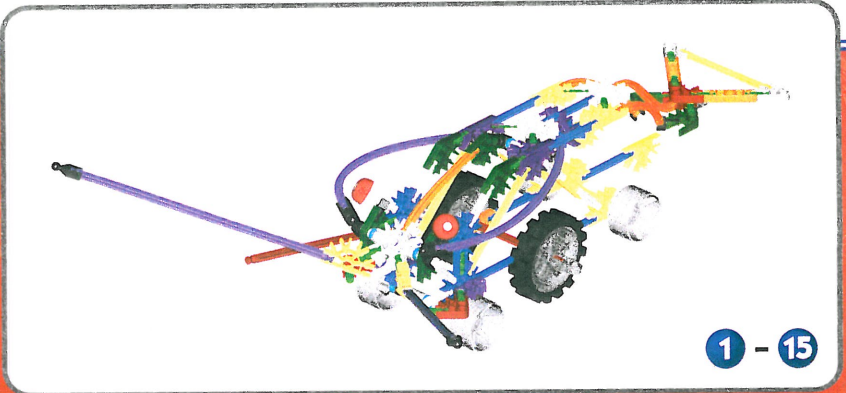

1 - 15

Licking Lizard

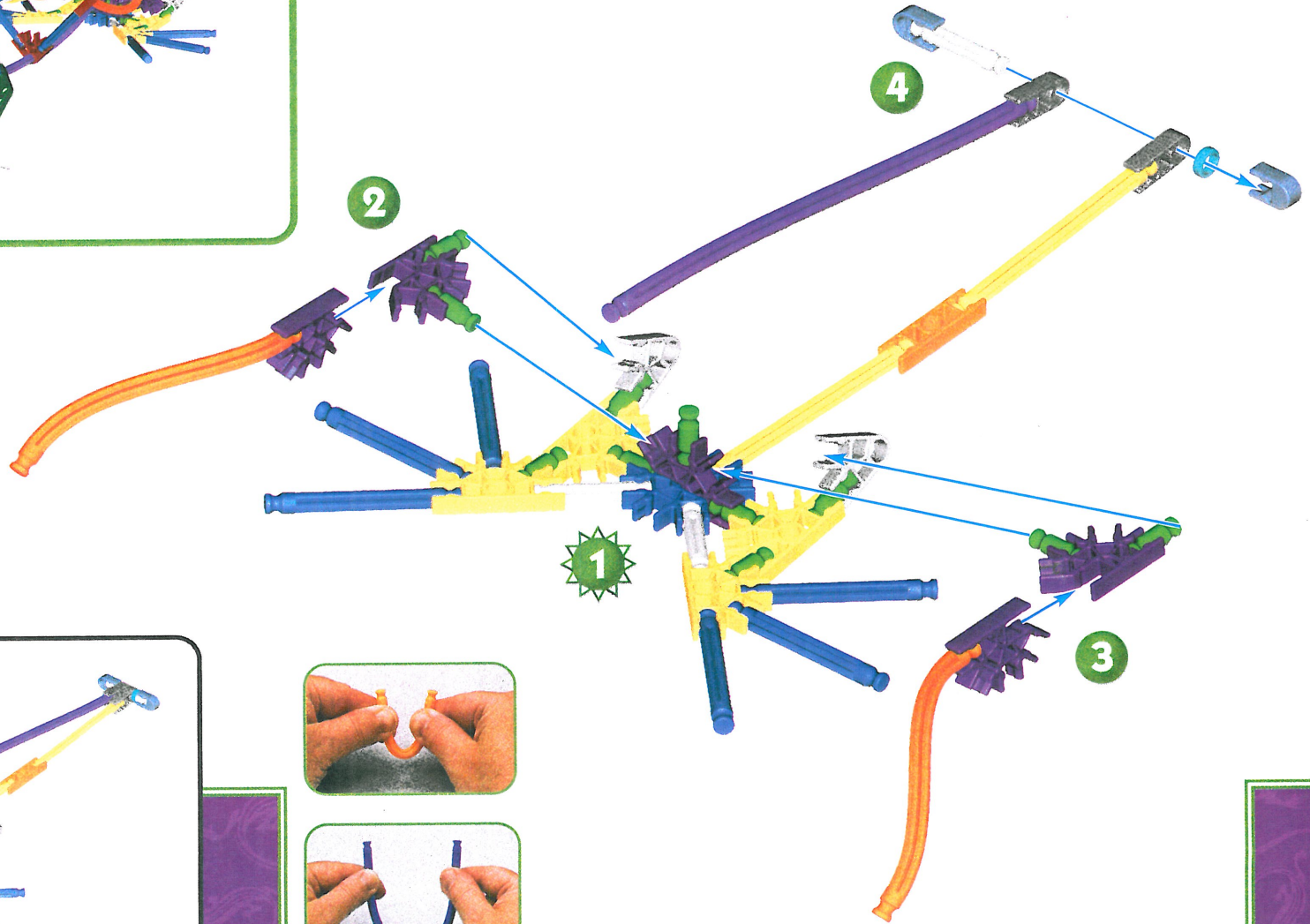

1 - 4

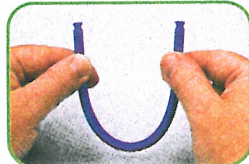
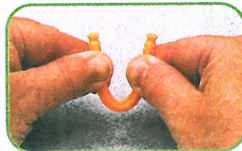

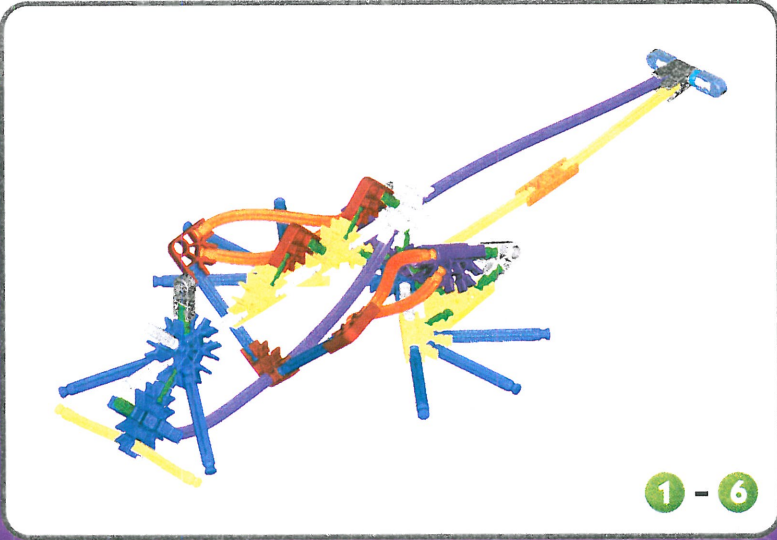
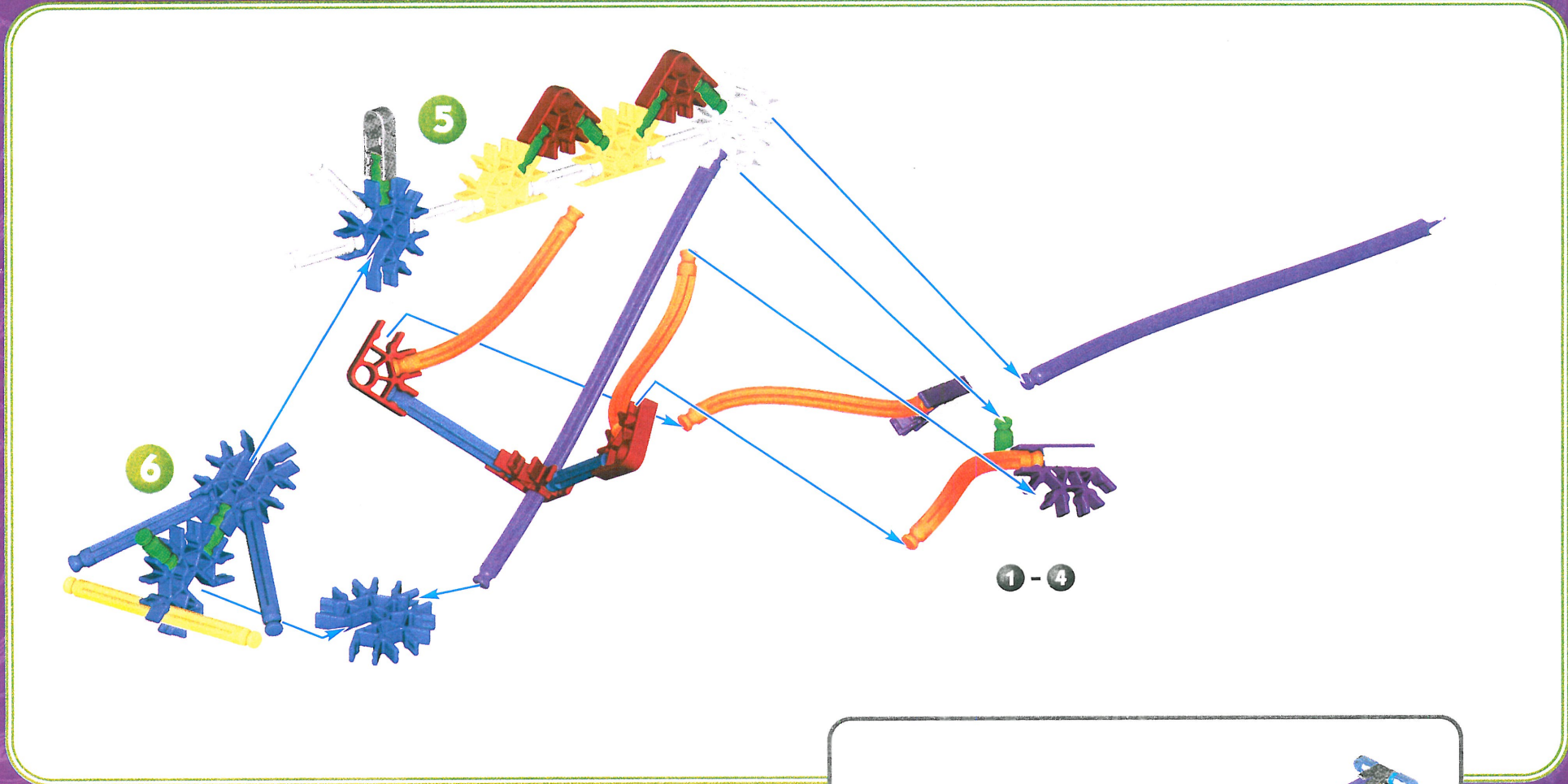



9

10

8

7

1 - 6

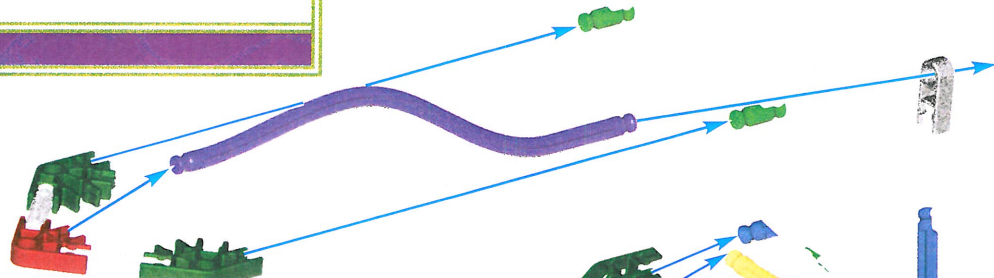

1 - 10

11

13

12



1 - 13

US GB **Other Building Ideas**

Want more building ideas? Try your creative building with these awesome models!

F **D'autres suggestions de construction**

Tu veux d'autres suggestions ? Fais appel à ta créativité en construisant ces modèles vraiment époustouflants !

E **Otras ideas para la construcción**

¿Quieres más ideas sobre la construcción? ¡Trata tu capacidad creativa con estos modelos asombrosos!

D **Weitere Bauiden**

Hast du immer noch nicht genug? Du willst noch mehr? Dann lass deiner Kreativität die Zügel schießen und baue diese ultimativen Modelle!

NL **Andere bouwideën**

Andere opbouwideën? Pas je eigen creatieve bouwideën toe met deze geweldige modellen!



Bunny

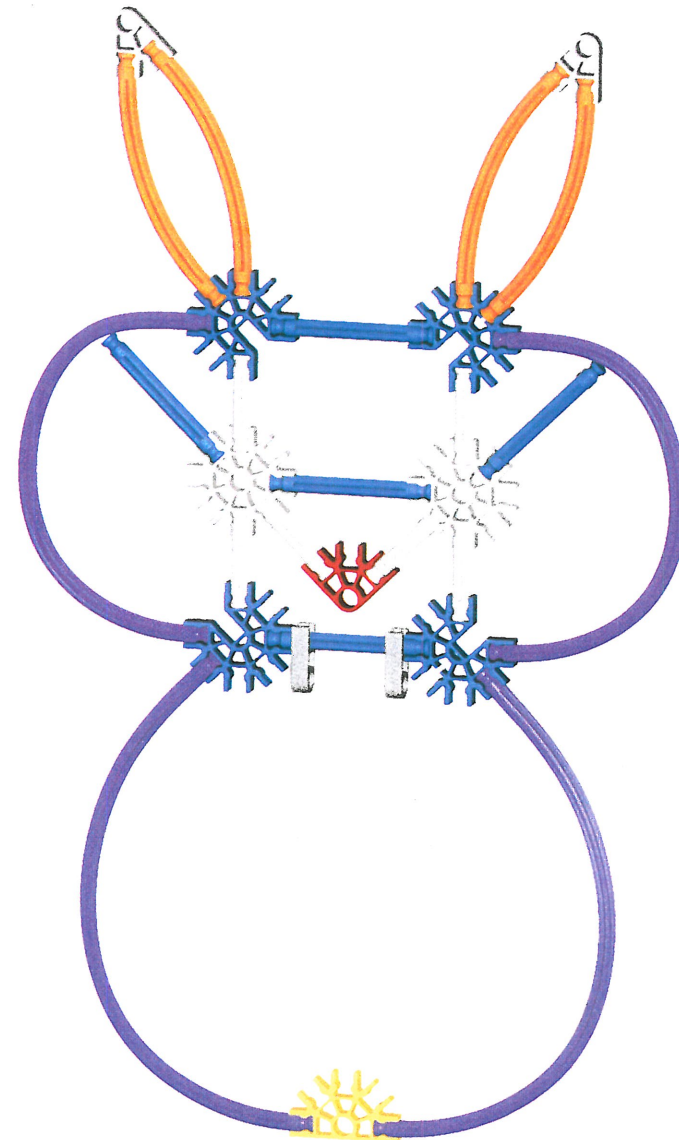



Cake

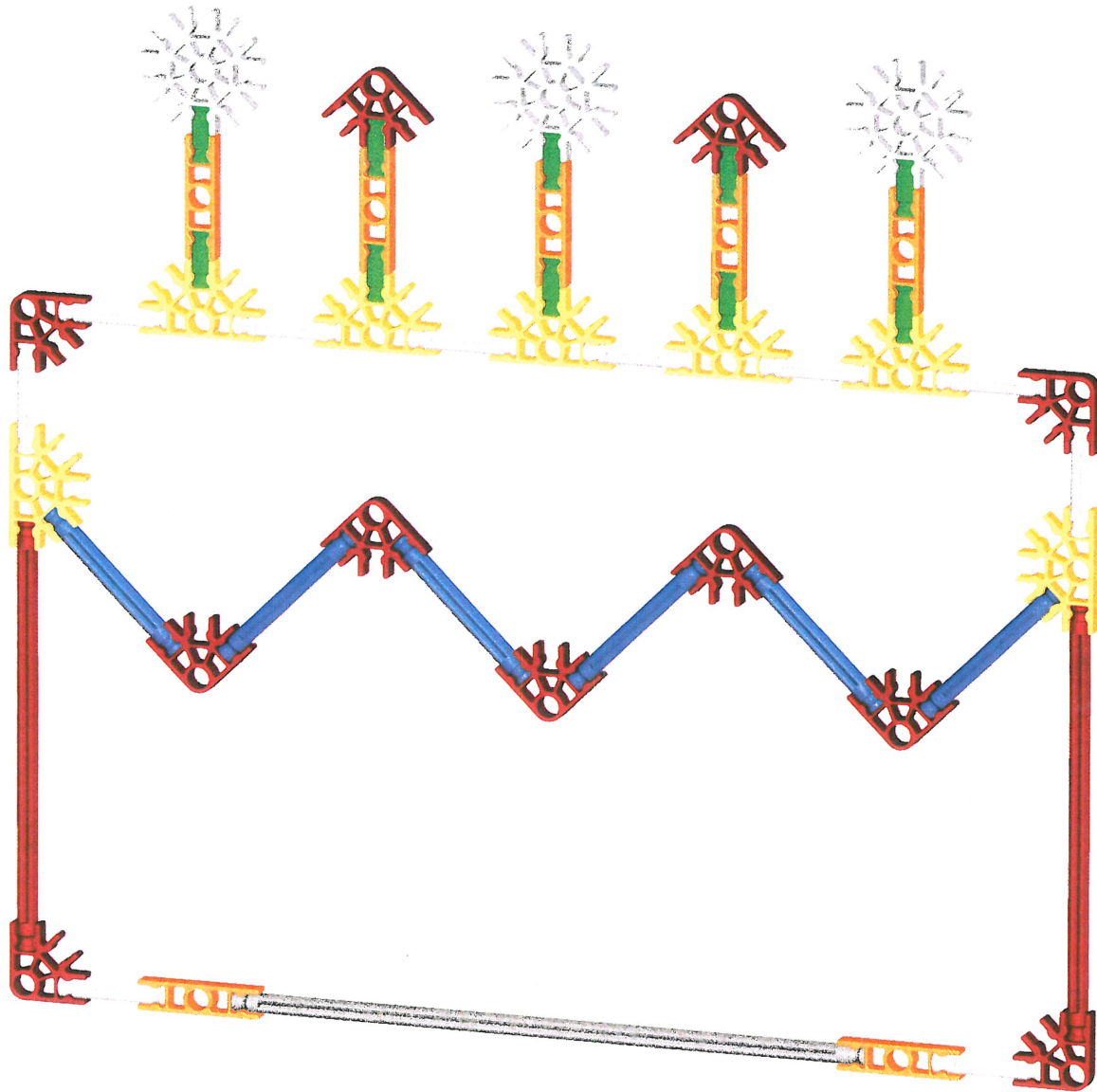



Jet

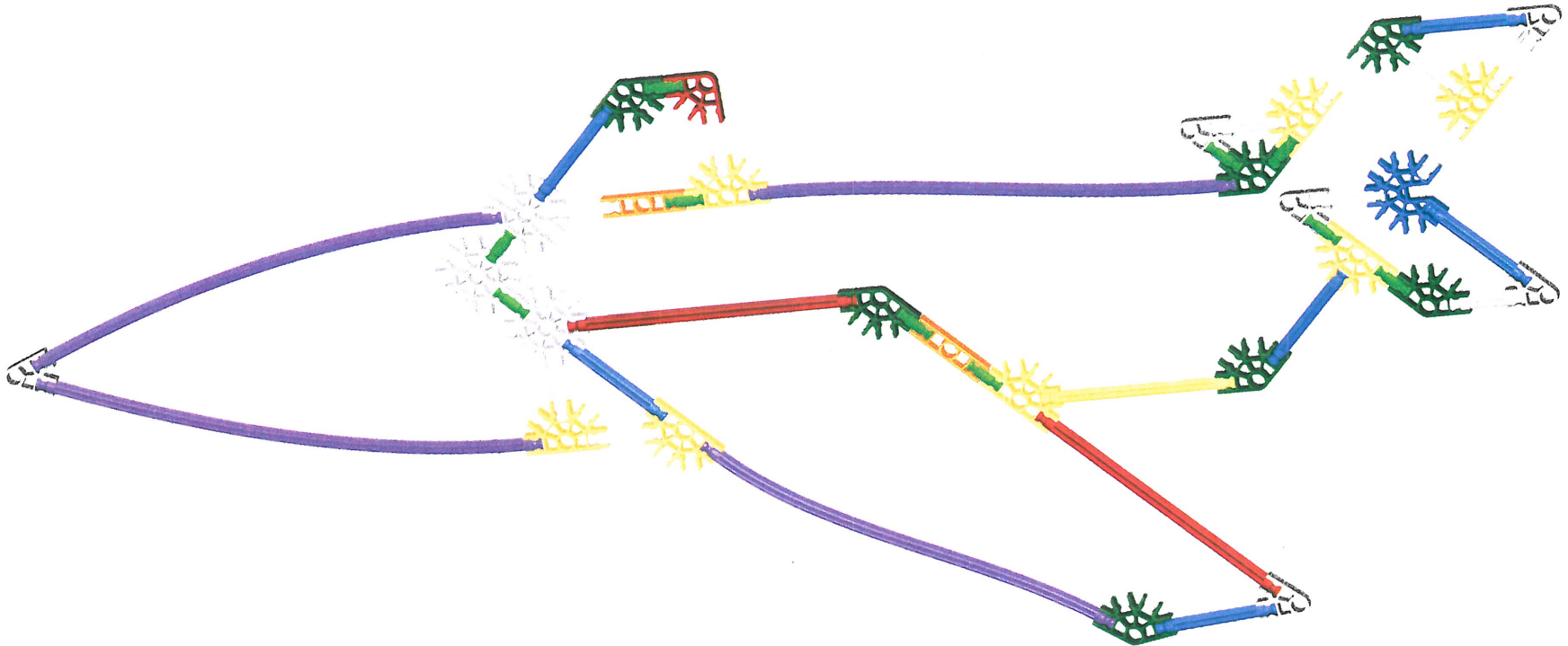



Rescue Axe

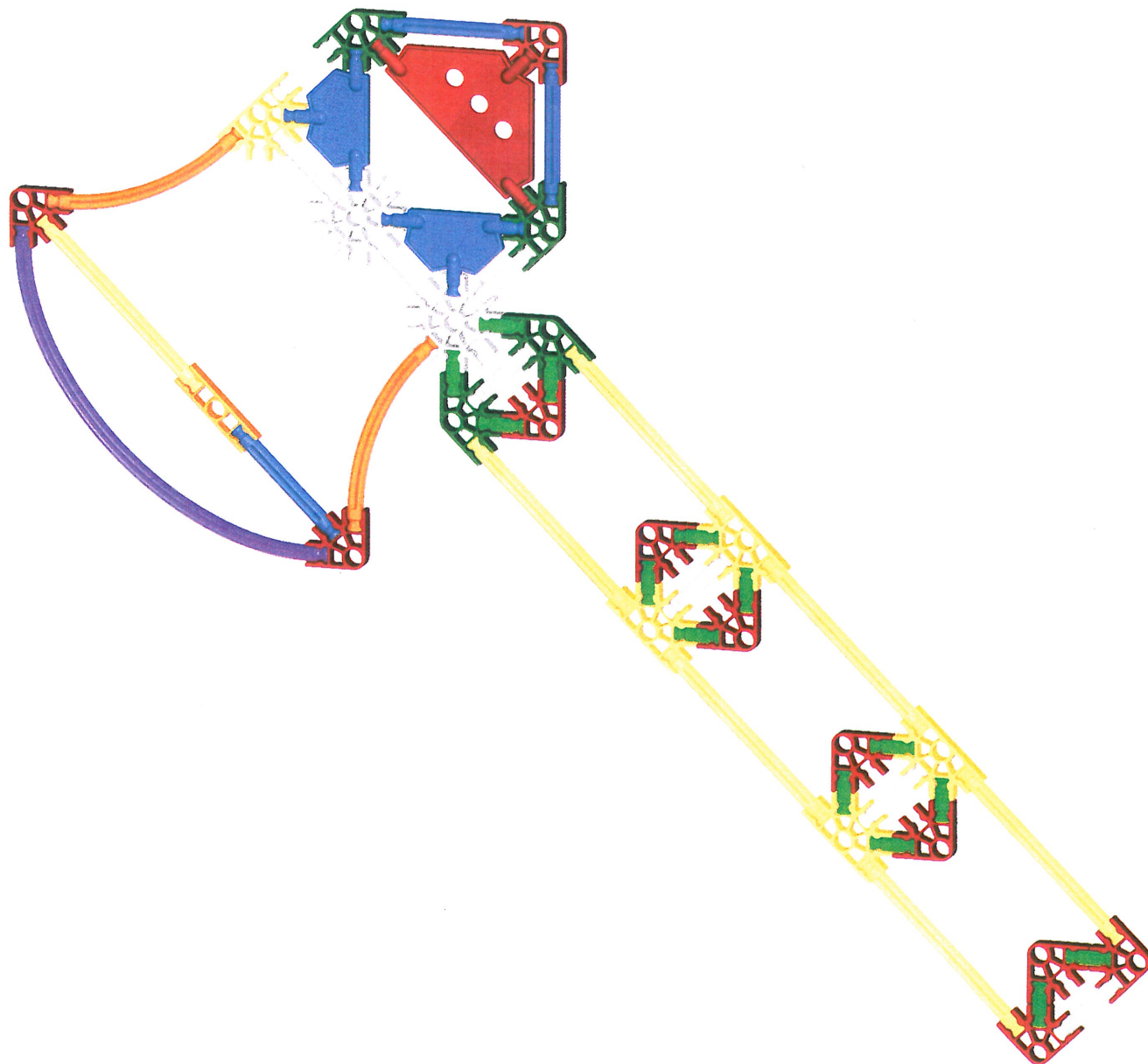



Swing Ride





Owl

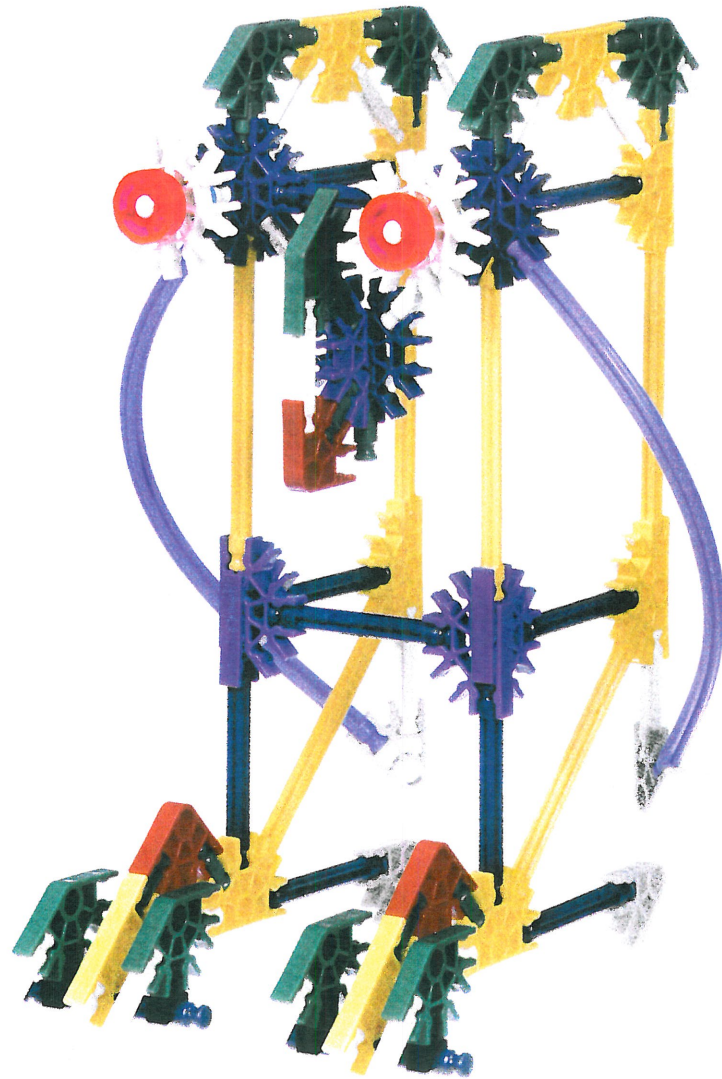



Beetle

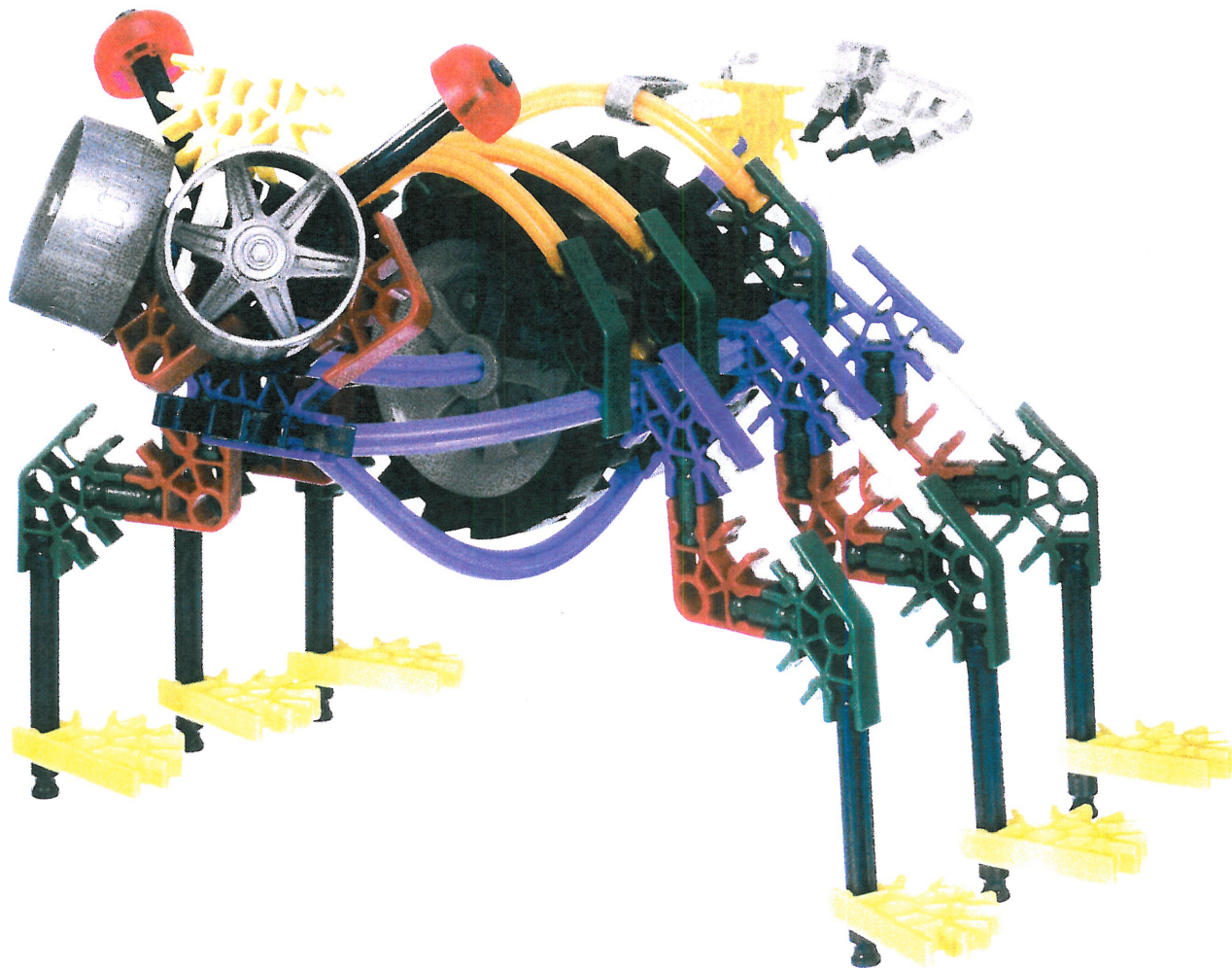



Chinese Junk Boat

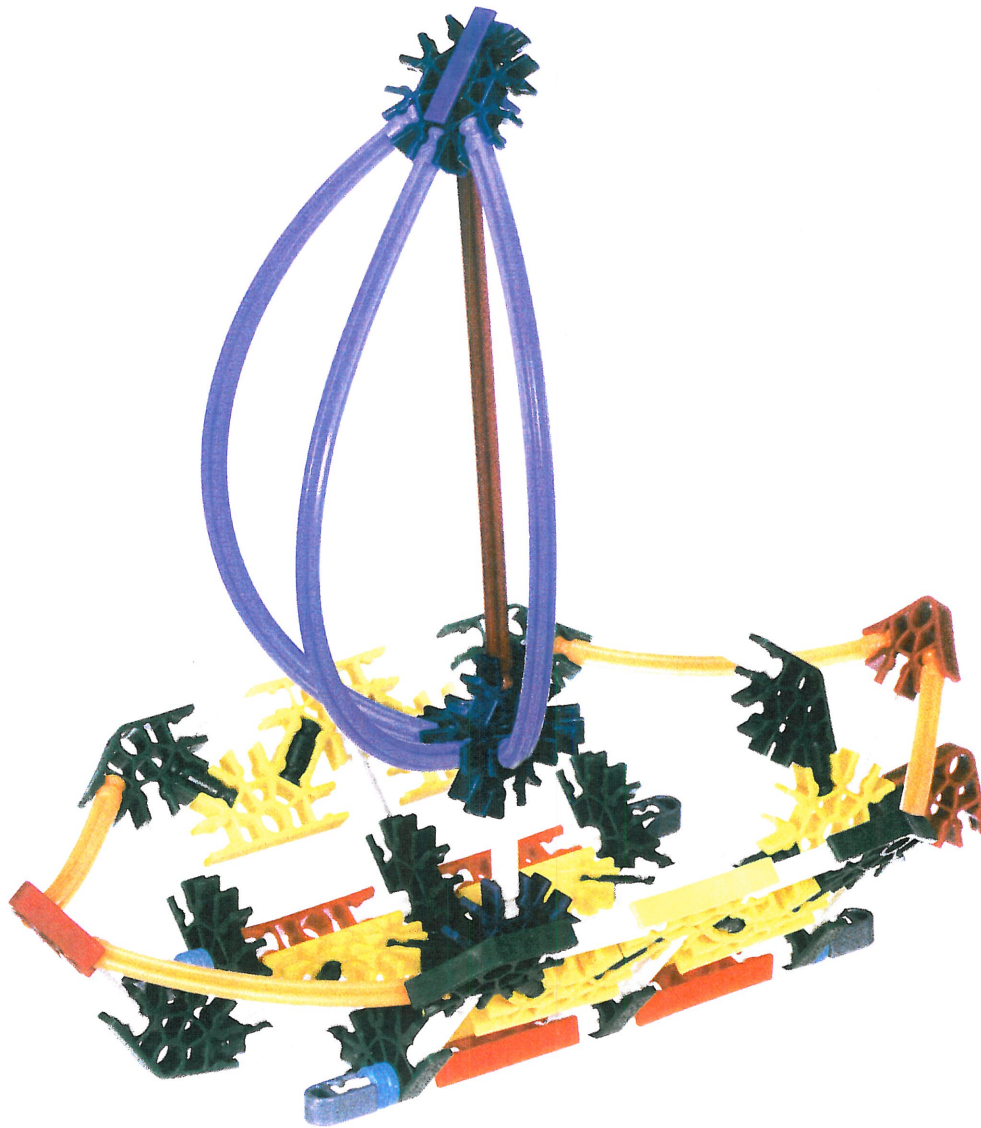

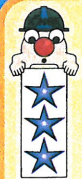

Stunt Plane





Dragster



What's Included

Be sure to compare the parts in your Fun Tub with the parts listed below. If anything is missing, check out the back cover of this instructions booklet for how to contact us. We're here to help!

- | | | | |
|----|--|---|--|
| 9 | | 4 | |
| 28 | | 4 | |
| 5 | | 2 | |
| 2 | | 1 | |
| 7 | | 4 | |
| 6 | | 2 | |
| 9 | | 2 | |
| 6 | | 2 | |
| 14 | | 2 | |
| 14 | | 2 | |
| 14 | | 4 | |
| 10 | | 2 | |
| 7 | | 2 | |
| 6 | | 4 | |
| 28 | | 2 | |
| 32 | | | |
| 14 | | | |
| 6 | | | |
| 8 | | | |
| 4 | | | |
| 6 | | | |



Bonjour!

F Le plaisir va commencer! J'ai conçu le système de construction K'NEX pour des enfants comme toi—des enfants qui veulent construire d'une façon tout à fait différente.

À l'aide de nostiges qui s'enclenchent, de connecteurs et d'instructions à code de couleur, tu peux construire et monter les modèles que nous avons conçus—ou bien, tu peux utiliser ton imagination et construire de fabuleux modèles de ta création personnelle! C'est ce que représente K'NEX se former une idée et la réaliser. Je l'ai fait moi-même quand j'ai inventé K'NEX!

*Joel Glickman
Inventeur de K'NEX*

À propos de la série

Tu adores construire des trucs ? Cette boîte de construction est vraiment pour toi alors ! Les fabuleux modèles présentés dans cette brochure feront appel à tes talents créatifs. Suis les instructions étape par étape, ou bien laisse libre cours à ton imagination, et invente d'autres modèles ! Il y a de quoi satisfaire tous les constructeurs, des débutants aux K'NEXperts!

Attention: Garde les cheveux, les doigts, la figure et les vêtements à l'écart de toutes les pièces mobiles.

Montage avec K'NEX

1. Bonjour! Je suis là pour t'aider à monter ton K'NEX. Trouveras des modèles pour trois niveaux de difficulté.

Cherche-moi sur la boîte avant de construire, je brandis un panneau pour t'indiquer le niveau de difficulté de chaque modèle...Regarde :



Défi amical



Défi modéré



Plus grand défi

Prépare-toi à construire

2. Pour commencer le modèle, trouve le numéro et suis les chiffres. Chaque pièce a sa propre forme et couleur. Il suffit de regarder l'illustration, de trouver les pièces dans ton jeu qui correspondent à ce que tu vois et de les enclencher. Essaie de tenir le modèle dans le même sens que dans l'illustration. Ainsi, tes pièces seront attachées correctement.

Continuation

3. Les couleurs affaiblies indiquent que cette partie est déjà montée. Tu dois raccorder la nouvelle partie à l'endroit indiqué par les flèches. Ces pièces seront en pleine couleur.

Pièces d'écartement

4. Il y a des endroits dans ton modèle où tu dois ajouter des pièces d'écartement bleues et argentées. Assure-toi d'utiliser la couleur exacte et de compter les pièces avec soin.

Connecteurs

5. Tu trouveras des connecteurs bleus et violets comportant des fentes extra-longues. Ils se glissent l'un dans l'autre tel qu'illustré. Pousse les pièces ensemble jusqu'à ce que tu entendes un "clac".

Le plaisir ne s'arrête pas si tu as perdu une pièce. Tu peux acquérir des pièces de remplacement pour le jeu K'NEX en appelant -800-KID-KNEX (Etat-Unis et Canada seulement) entre 8.30 et 17 heures (heure de l'est des Etats-Unis), de lundi à vendredi.

E Acerca del conjunto

¿Te gusta construir? ¡Este conjunto de construcción es especialmente para ti! Trata tu capacidad creativa para la construcción con los asombrosos modelos que se muestran en este libro. Sigue paso a paso las instrucciones o usa tu imaginación para construir tus propias creaciones. Hay algo para cada uno, ¡desde principiantes hasta K'NEXperts!

Construcción con K'NEX

1. ¡Hola! Soy tu compañero en la construcción. Encontrarás modelos para tres niveles de construcción. Búscame antes de cada construcción, estaré sosteniendo un cartel que te dirá cuánto puede ser difícil.



Moderado desafío



Enorme desafío

Amigable desafío

Todo listo, comienza a construir

2. Para comenzar tu modelo, busca el 1 y sigue los números. Cada pieza tiene su propia forma y color. Simplemente mira los dibujos, busca las piezas correspondientes en tu juego y después conéctalas. Mientras construyes, trata de colocar tu modelo en la misma dirección que se muestra en las instrucciones.

Continúa

3. Los colores desteñidos muestran que esta sección ya está construida. Conecta las nuevas secciones en los lugares señalados por las flechas. Las nuevas piezas que agregues estarán en colores vivos.

Espaciadores

4. Hay lugares en tu modelo donde tendrás que agregar Espaciadores azules y plateados. Cerciórate de usar el color correcto y cuéntalos con cuidado.

Conectores

5. Hay conectores azules y púrpura con ranuras largas especiales. Se enganchan deslizándose como ves en los dibujos. Conecta estas piezas empujándolas hasta que oigas "clic".

Precaución: Mantén el cabello, los dedos, la cara y la ropa alejada de las piezas móviles.

D Informationen zum Bausatz

Wenn du gerne baust, ist dieser Bausatz ideal und genau das Richtige für dich! Lass deiner Kreativität beim Bauen der tollen Modelle, die du in diesem Buch siehst, freien Lauf. Befolge einfach die schrittweisen Anweisungen, oder lass dich von deiner Fantasie leiten und baue deine eigenen Kreationen! Hier gibt es etwas für jeden Geschmack und für jedes Niveau, vom Anfänger bis hin zu den K'NEXperts!

Bauen mit K'NEX

1. Hallo, ich bin dein K'NEX-Bauhelfer. Es gibt drei Schwierigkeitsstufen. Schau nach mir bevor du mit dem Bau eines Modells beginnst. Auf einem Schild zeige ich dir den Schwierigkeitsgrad für jedes Modell:



einfach



mittel



schwieriger

Achtung - und los geht's

2. Um mit dem Bau deines Modells zu beginnen, suchst du zuerst das Teil mit der Nummer 1, dann das mit der Nummer 2 und so weiter. Jedes Teil hat eine bestimmte Form und Farbe. Schau einfach auf das Bild und suche dann die gleichen Teile in deinem Bausatz. Dann steckst du die Teile zusammen. Am besten ist es, wenn du die Teile im selben Winkel hältst, wie in der Abbildung, damit du sie an der richtigen Stelle anbringst.

Und weiter geht's

3. An den blassen Farben kannst du erkennen, welcher Teil bereits fertig ist. Das neue Teil gehört da hin, wo Pfeile hin zeigen. Dieser Teil ist in bunter Farbe.

Abstandsstücke

4. An bestimmten Stellen in deinem Modell musst du Abstandshalter, sogenannte Spacer, einbauen. Diese Abstandshalter sind blau und silberfarben. Achte darauf, dass du die richtige Farbe wählst und dass du die richtige Anzahl davon verwendest.

Verbindungsstücke

5. Blaue und purpurn Steckanschlüsse haben besonders lange Schlitze. Wie du auf der Abbildung sehen kannst, lassen sie sich ineinander schieben. Achte beim Aneinanderfügen dieser Teile darauf, dass du ein Klickgeräusch hörst. Erst dann sind die Teile fest miteinander verbunden.

Vorsicht: Haare, Finger, Gesicht und Kleidungsstücke nicht mit beweglichen Teilen in Berührung kommen lassen.

NL Aangaande het geheel

Hou je van bouwen? Dit bouwgeheel is speciaal voor jou bestemd! Werk je creativiteit uit met de fantastische modellen die afgebeeld staan in dit boek. Gebruik de geleidelijke instructies, of gebruik je verbeelding om je eigen creaties te bouwen! Er is iets voor iedereen, van beginners tot K'NEXperts!

Bouwen met K'NEX

1. Ho! Ik ben je K'NEX bouwvriend. Je vindt modellen voor drie bouwpeilen. Voor je begint te bouwen, kijk even naar me uit met mijn kenteken om je aan te tonen hoe moeilijk elk model zal zijn ... kijk maar:



Niet moeilijk



Nogal moeilijk



Zeker moeilijk

Klaar - Bouwen maar

2. Om met je model te beginnen, zoek naar 1 en volg de nummers. Elk onderdeel heeft dezelfde vorm en kleur. Kijk gewoonweg naar de afbeelding, vind in je geheel de stukken die overeenstemmen met wat je ziet en druk ze in mekaar. Tracht je model in dezelfde richting te behouden als op de afbeelding zodat je de stukken op de juiste plaats zult vastmaken.

Verder ...

3. De vage kleuren duiden aan dat dit gedeelte reeds opgebouwd is. Het nieuwe deel moet aangebracht worden op de plaats waarop de peilen gericht zijn. Dit stuk zal in volle kleur aangetoond zijn.

Afstandsstukken

4. In je model zijn er plaatsen waar blauwe en zilveren tussenstukken moeten toegevoegd worden. Verzeker je ervan de juiste kleur te gebruiken en tel ze zorgvuldig.

Koppelstukken

5. Er zijn blauwe en purper koppelstukken met speciale lange gleuven. Ze schuiven in mekaar zoals je kunt zien op de afbeeldingen. Duw deze onderdelen in mekaar tot je een "klik" hoort.

Opgepast: Hou het haar, de vingers, het gezicht en kledij verwijderd van alle bewegende onderdelen.

250+

PIECE / PIEZA

VALUE TUB

Product and colors may vary.
Models can be built one at a time.
K'NEX is a registered trademark of K'NEX Industries, Inc.
Printed in China

Manufactured under U.S. Patents 5,061,219; 5,137,486; 5,199,919;
5,238,438; 5,346,420; 5,350,331; 5,368,514; 5,421,762; 5,423,707;
5,427,559; 5,518,435; D388,509; D388,475; D389,203; D391,843;
D391,921; D392,555; D403,722; 5,913,706; 6,089,941.

Other U.S. and foreign patents pending. Conforms to the
Requirements of ASTM Standard Consumer Safety
Specification on Toy Safety, F963-96a.

Le produit et les couleurs peuvent varier.
La plupart des modèles peuvent être construits un à la fois.
K'NEX est une marque déposée de K'NEX Industries, Inc.
Imprimerie aux China

Fabriqué sous brevets américains 5,061,219; 5,137,486;
5,199,919; 5,238,438; 5,346,420; 5,350,331; 5,368,514;
5,421,762; 5,423,707; 5,427,559; 5,518,435; D388,509;
D388,475; D389,203; D391,843; D391,921; D392,555;
D403,722; 5,913,706; 6,089,941.

Autres brevets américains et étrangers en instance.
Conforme aux spécifications de sécurité du
consommateur sur la sécurité des jouets de la norme
ASTM F963-96a.



©2004 K'NEX Industries, Inc.
P.O. Box 700
Hatfield, PA 19440-0700



US 1-800-KID-KNEX US/Canada only (English only)

GB 00800-22427276 UK/Ireland only

F E D NL 001-215-996-4823



US Consumer Services
K'NEX Industries, Inc.
P.O. Box 700
Hatfield, PA 19440-0700



GB K'NEX
Newport Consumer Services
Hasbro UK Ltd., Caswell Way
Newport, Gwent NP9 0YH

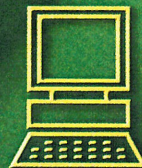

www.knex.com

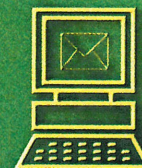

email@knex.com

93186-V2-05/04