

K'NEX

# CEMENT TRUCK

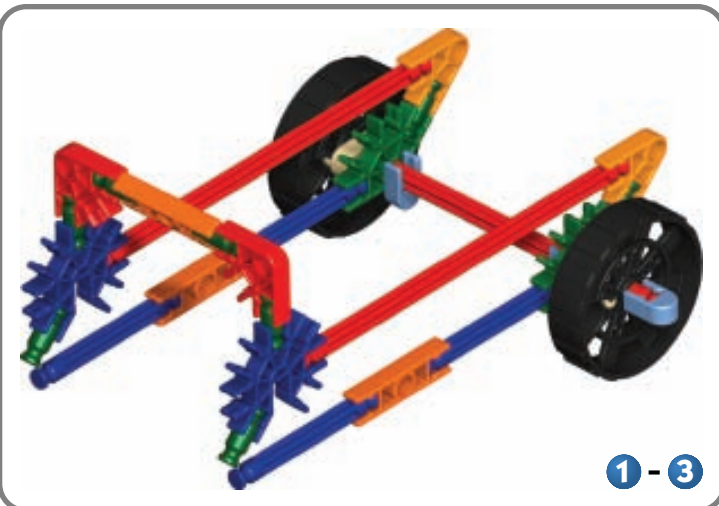

GEAR ACTION™



1 - 3

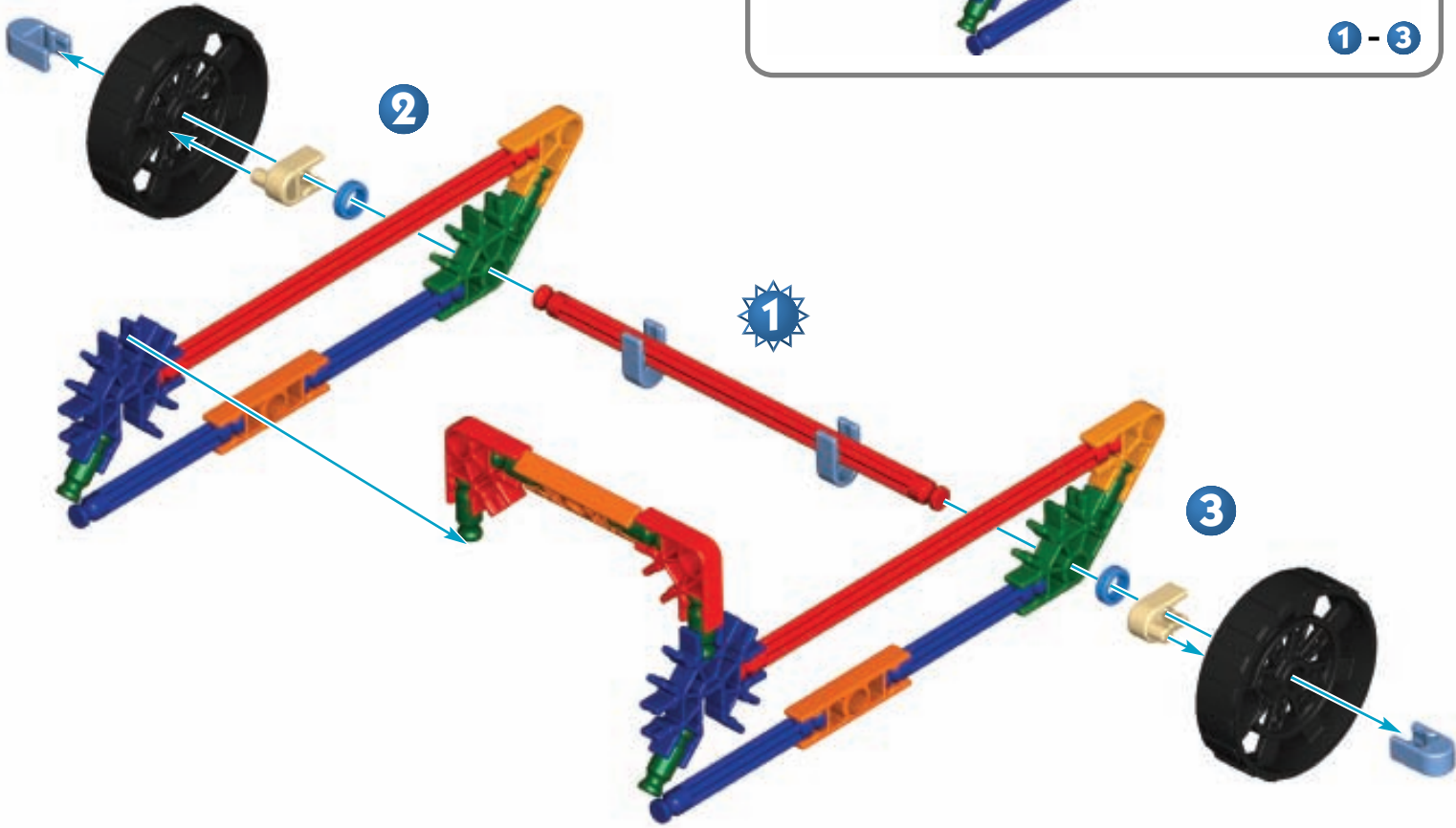

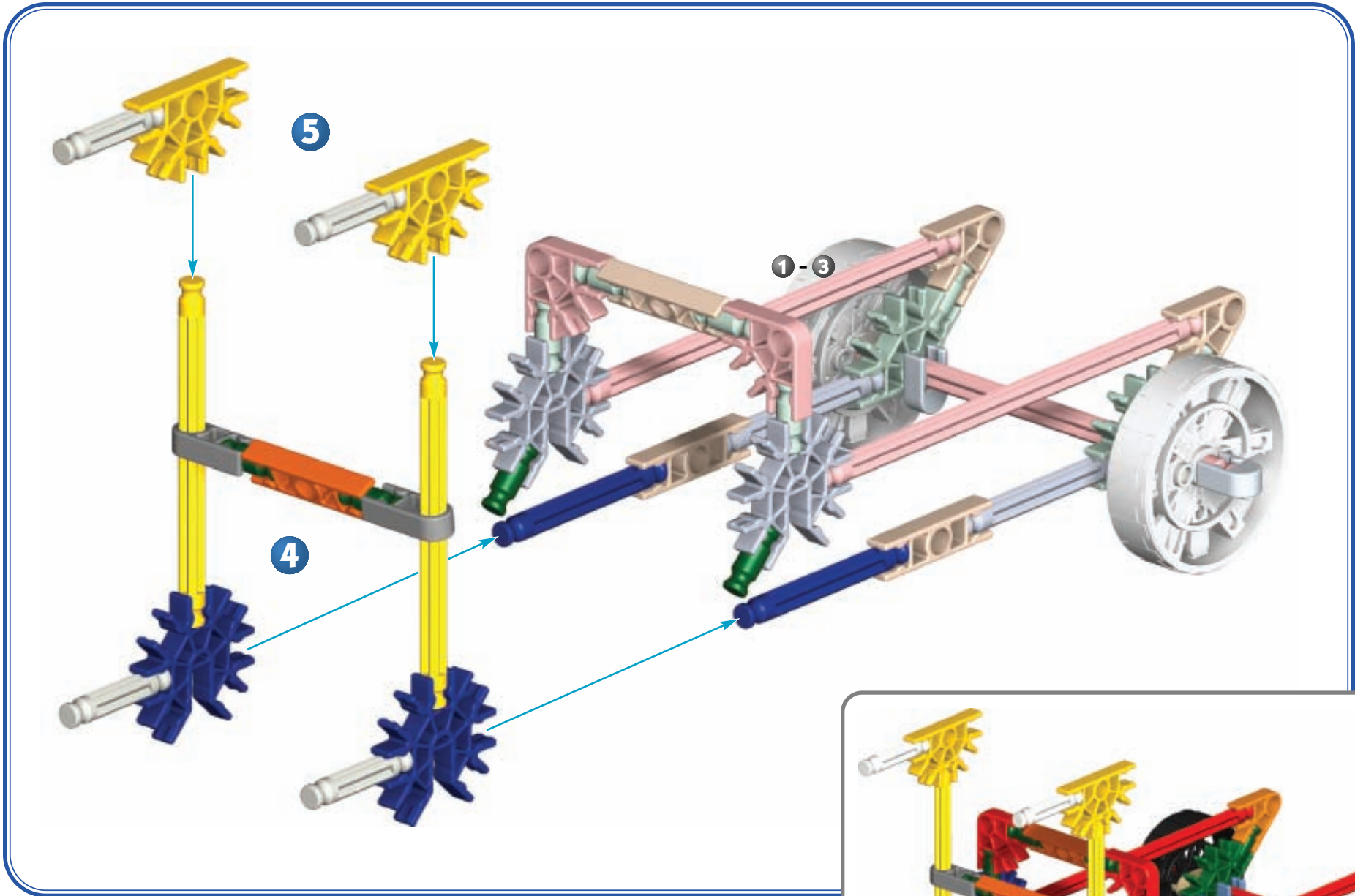

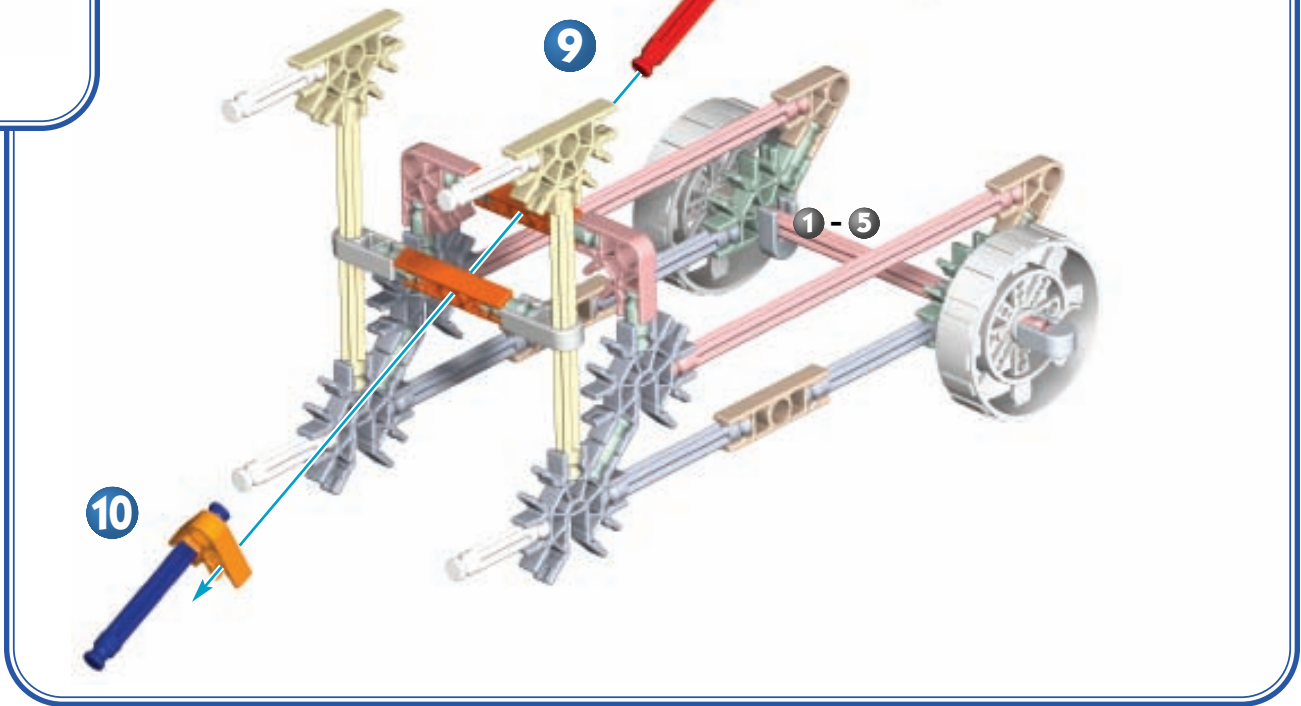
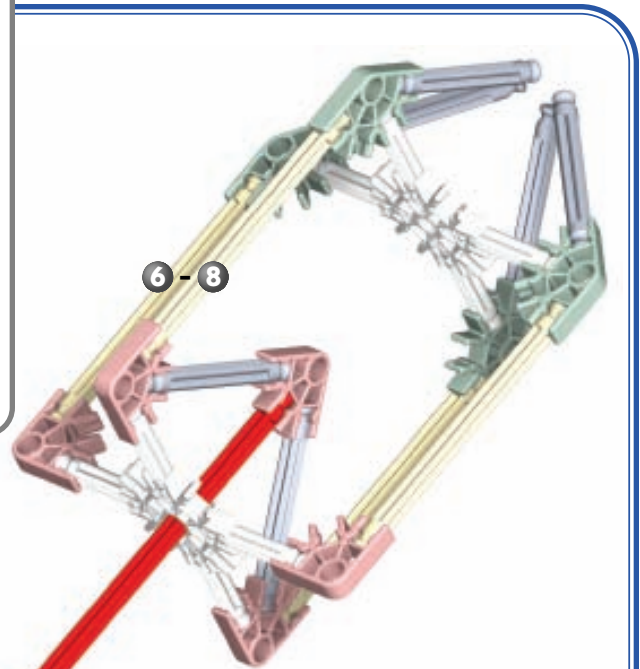
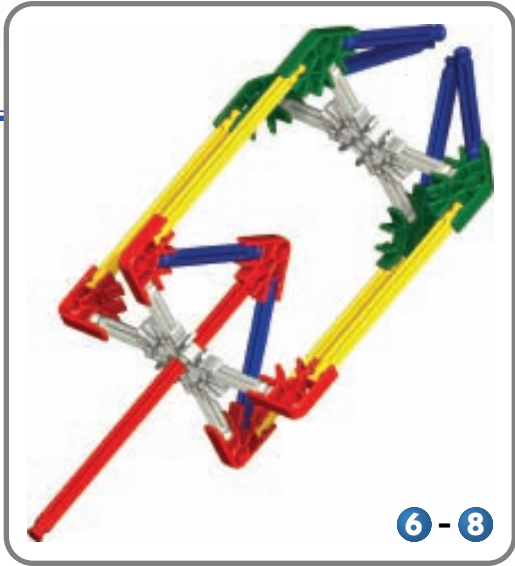
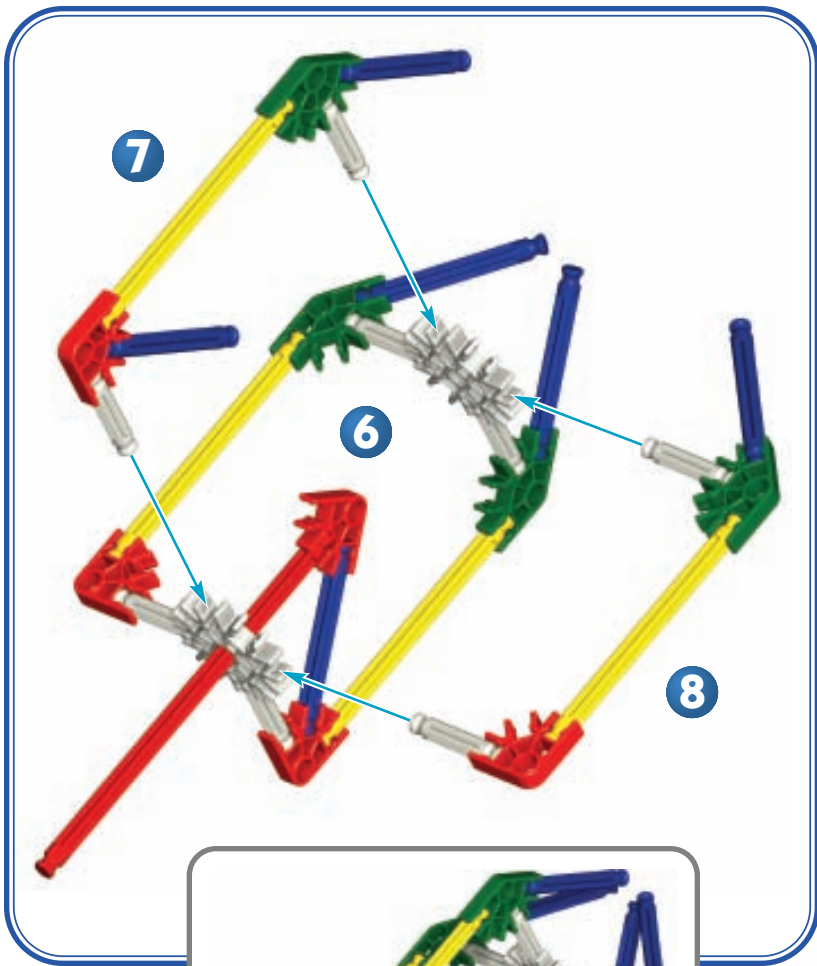

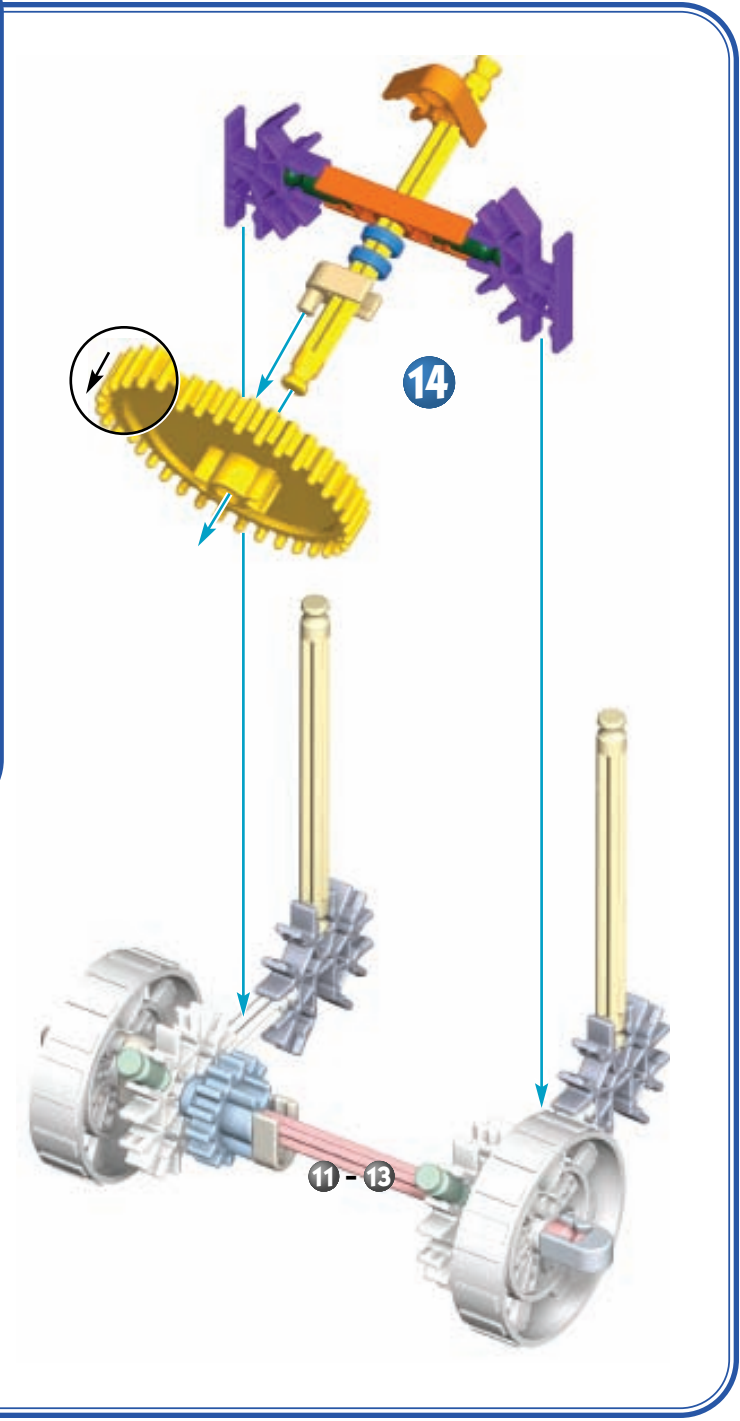
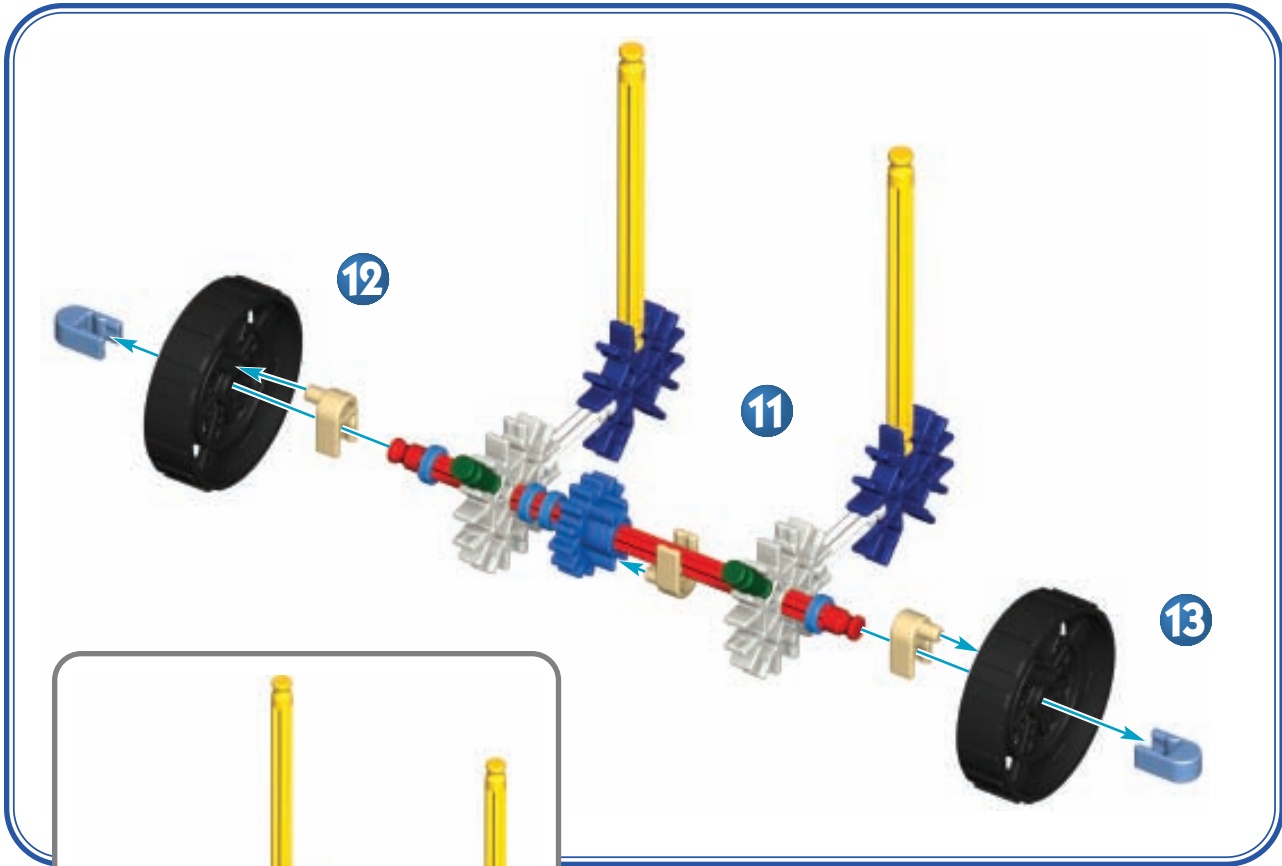

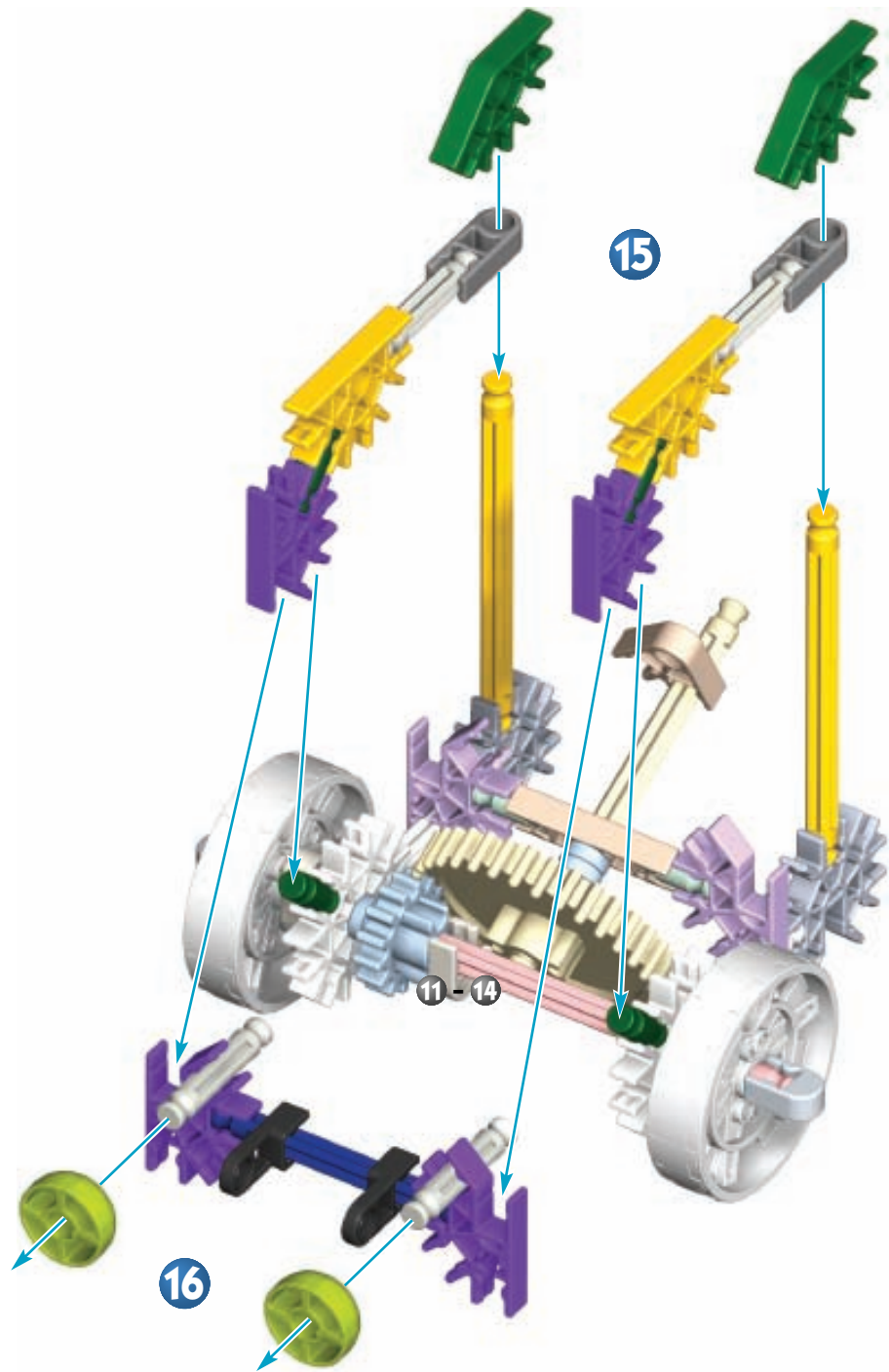

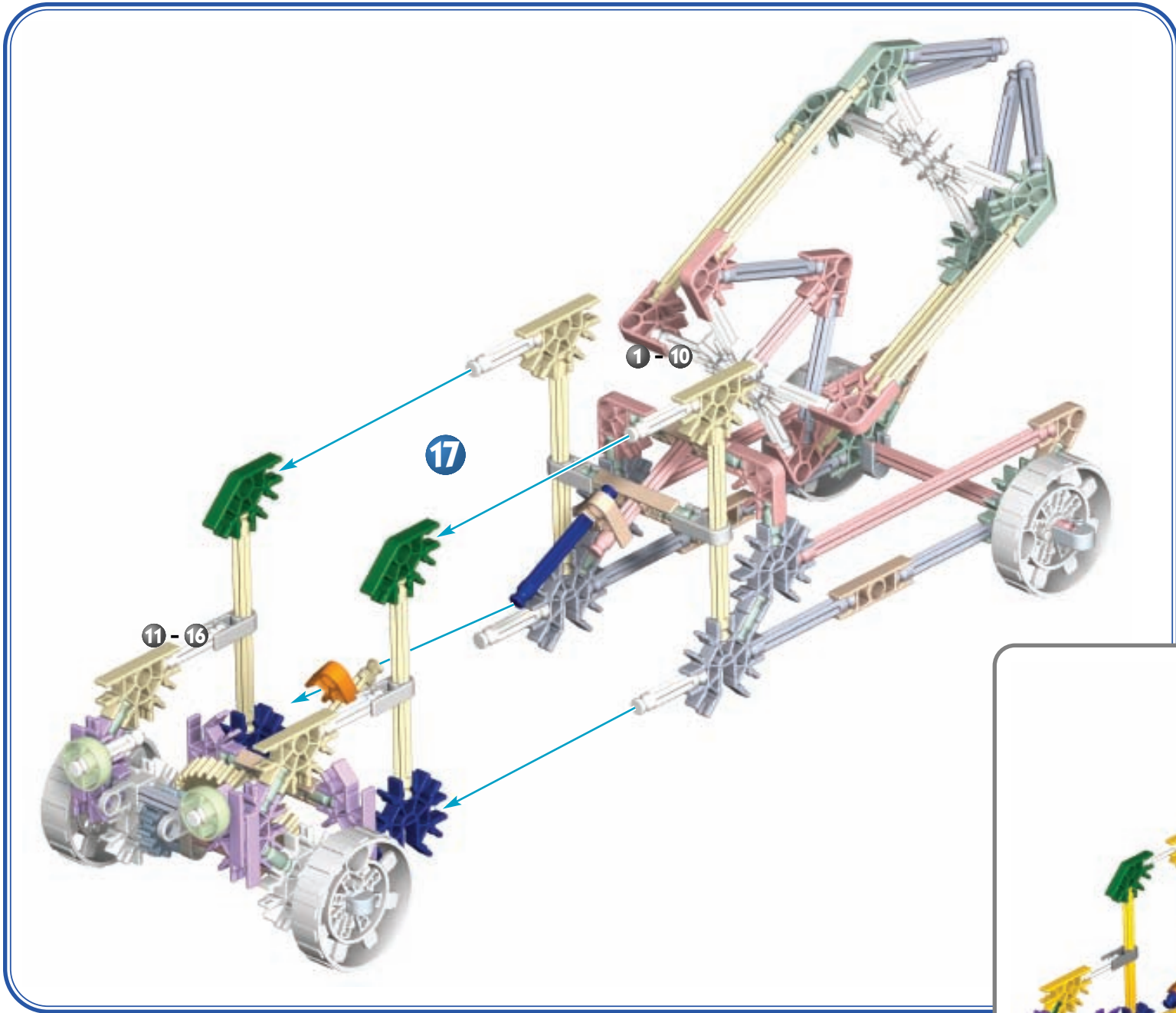



# CYCLE GAS STATION



**GEAR ACTION™**

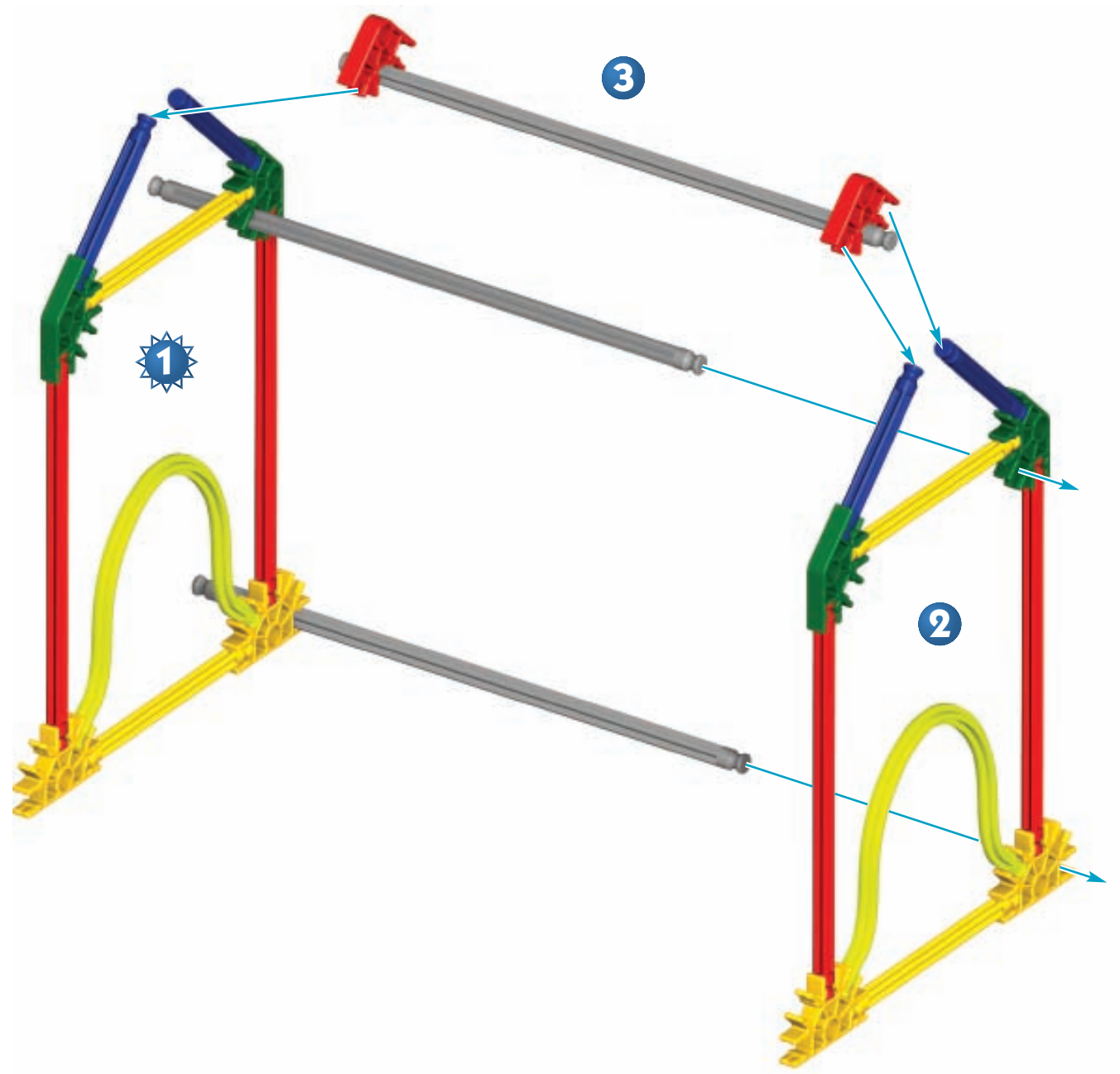

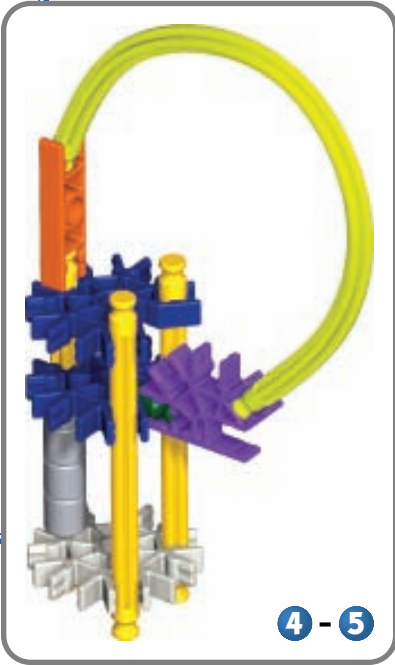
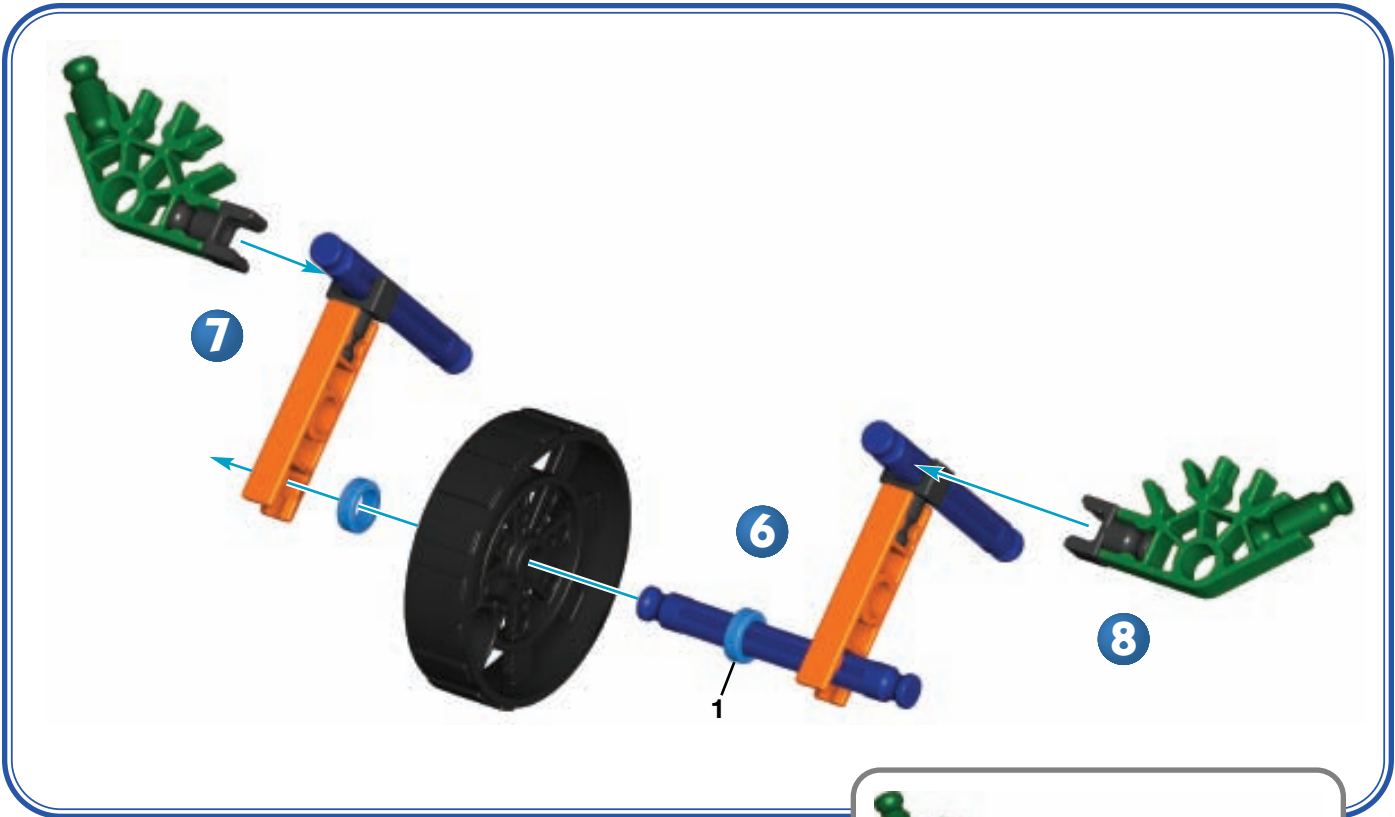
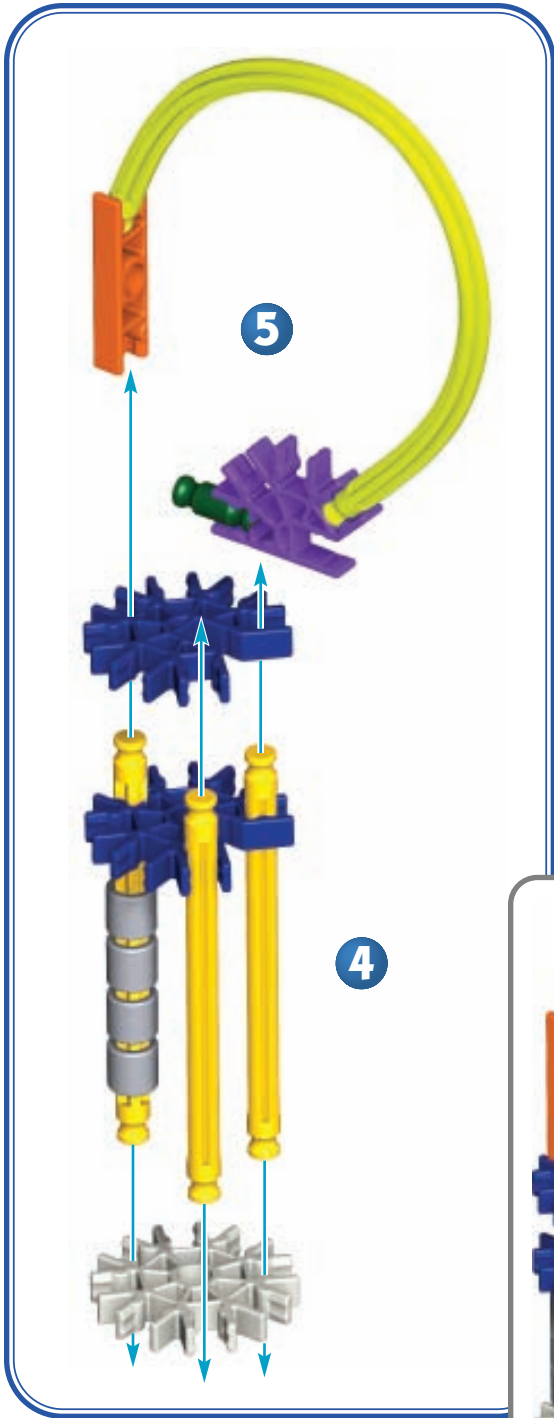



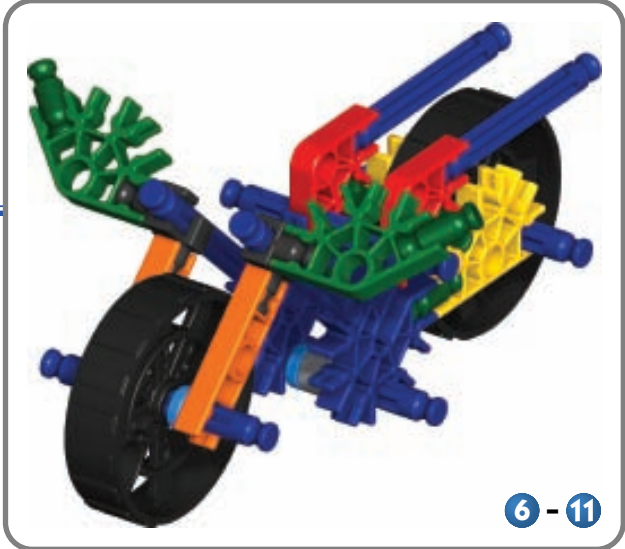
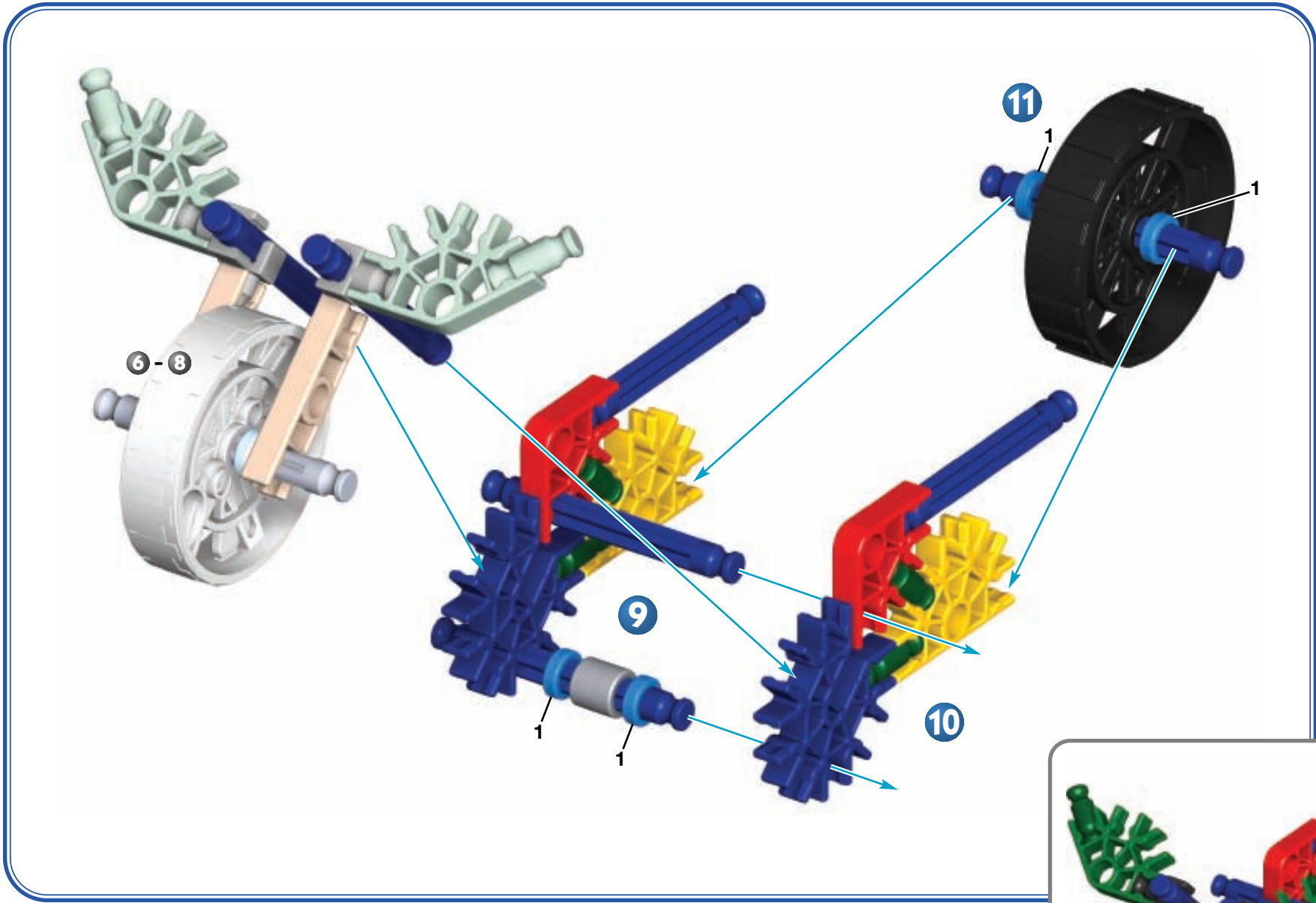

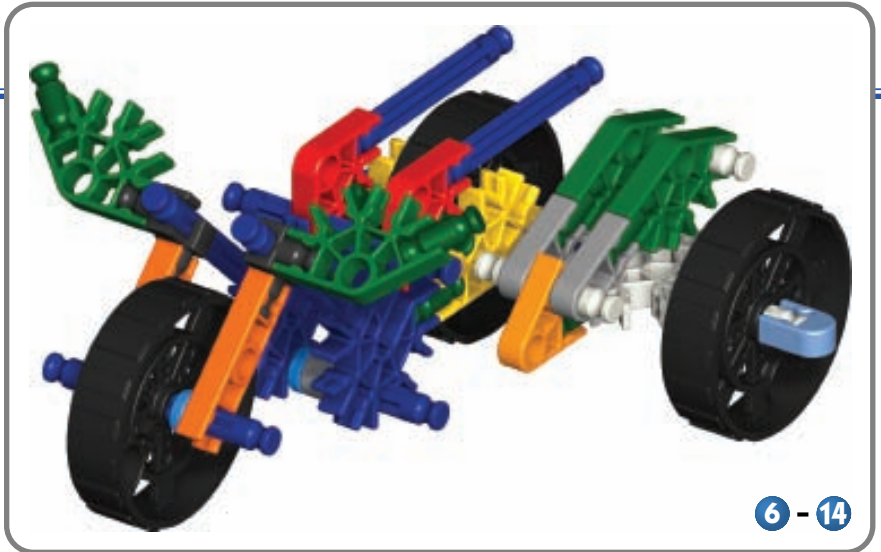
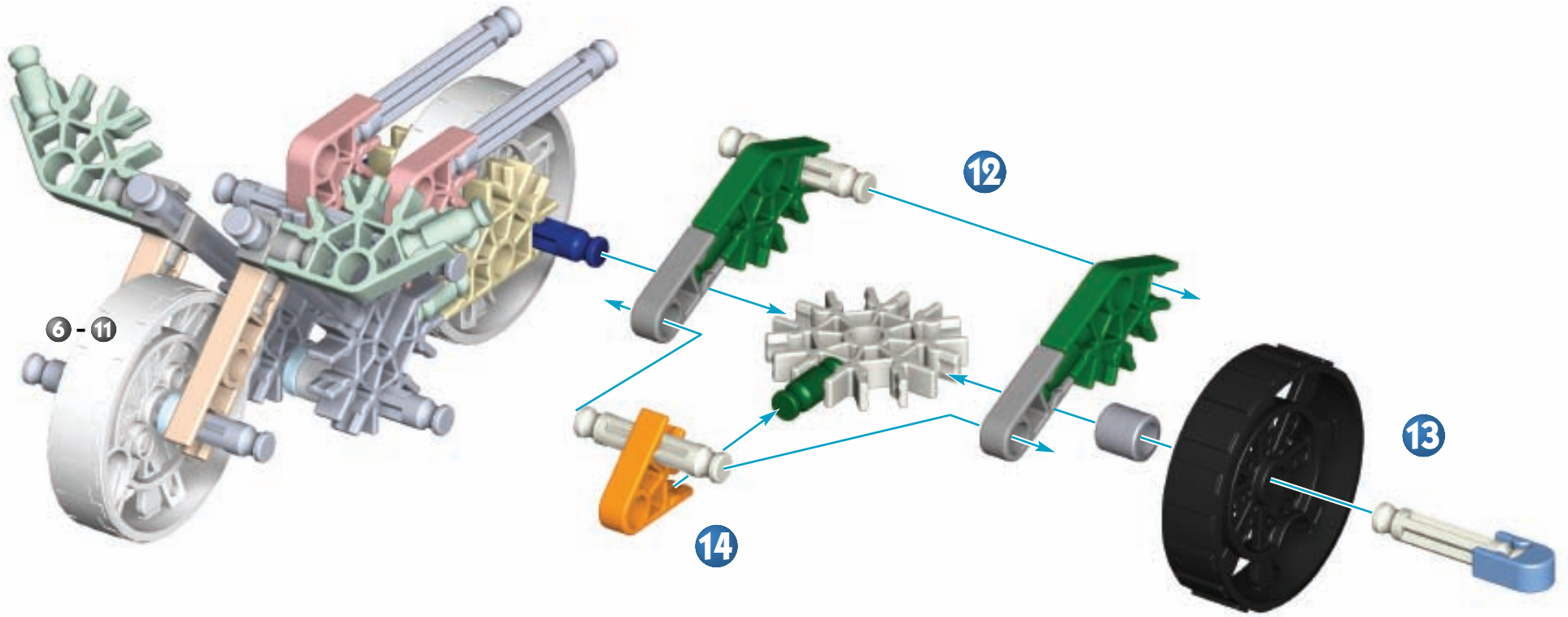



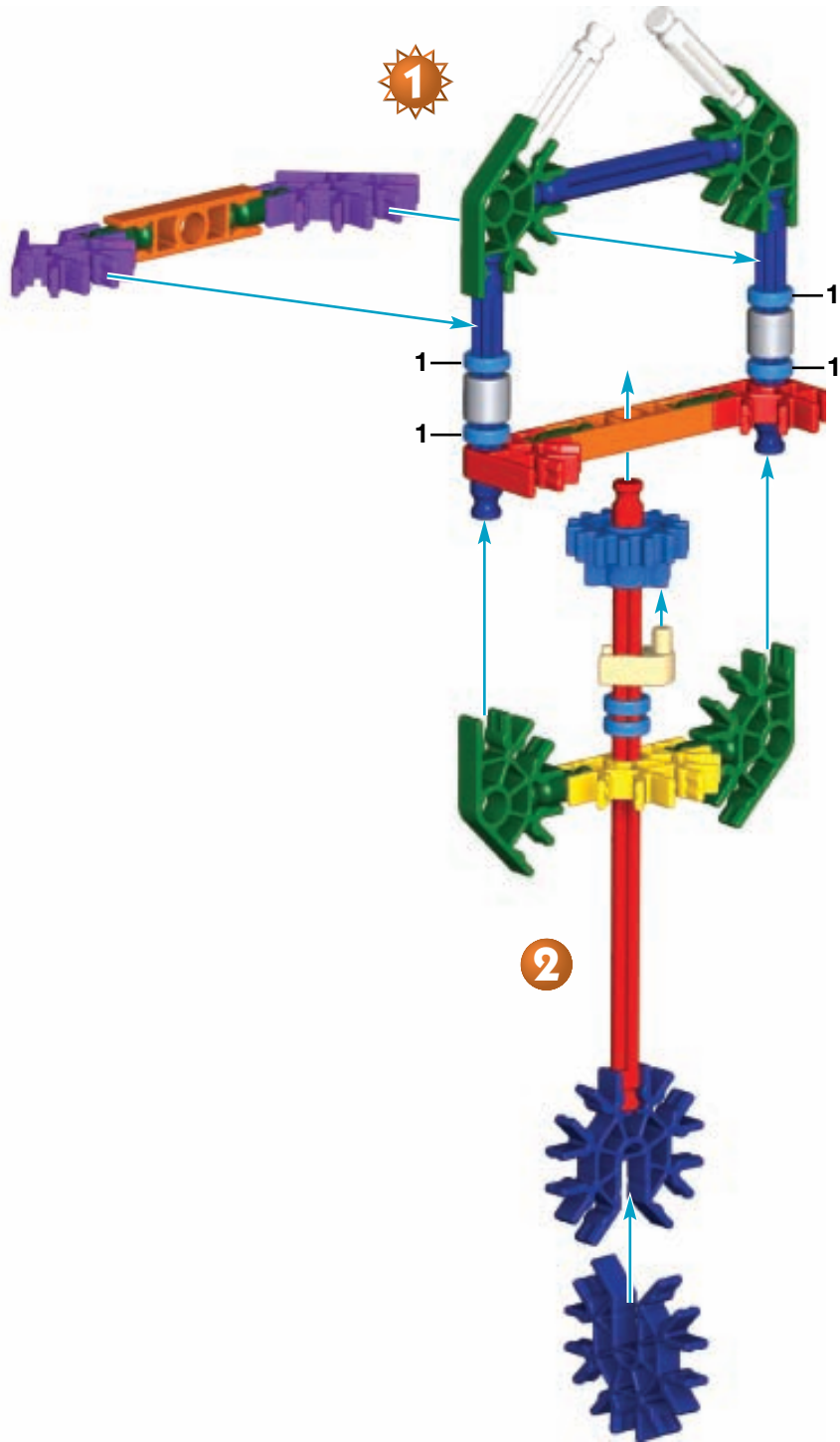

**x2**

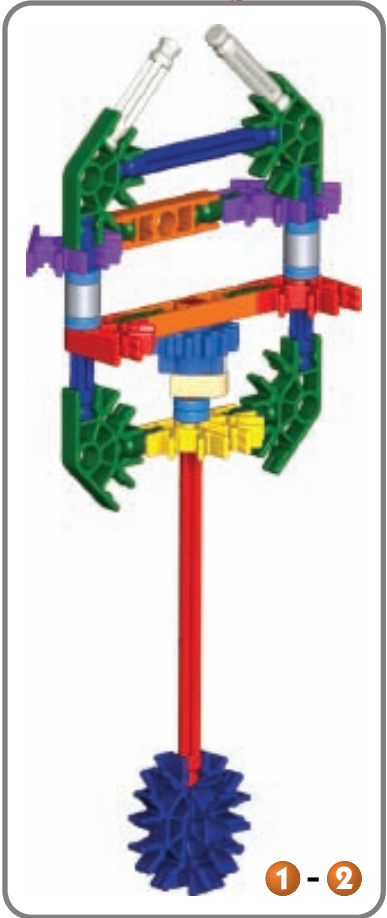

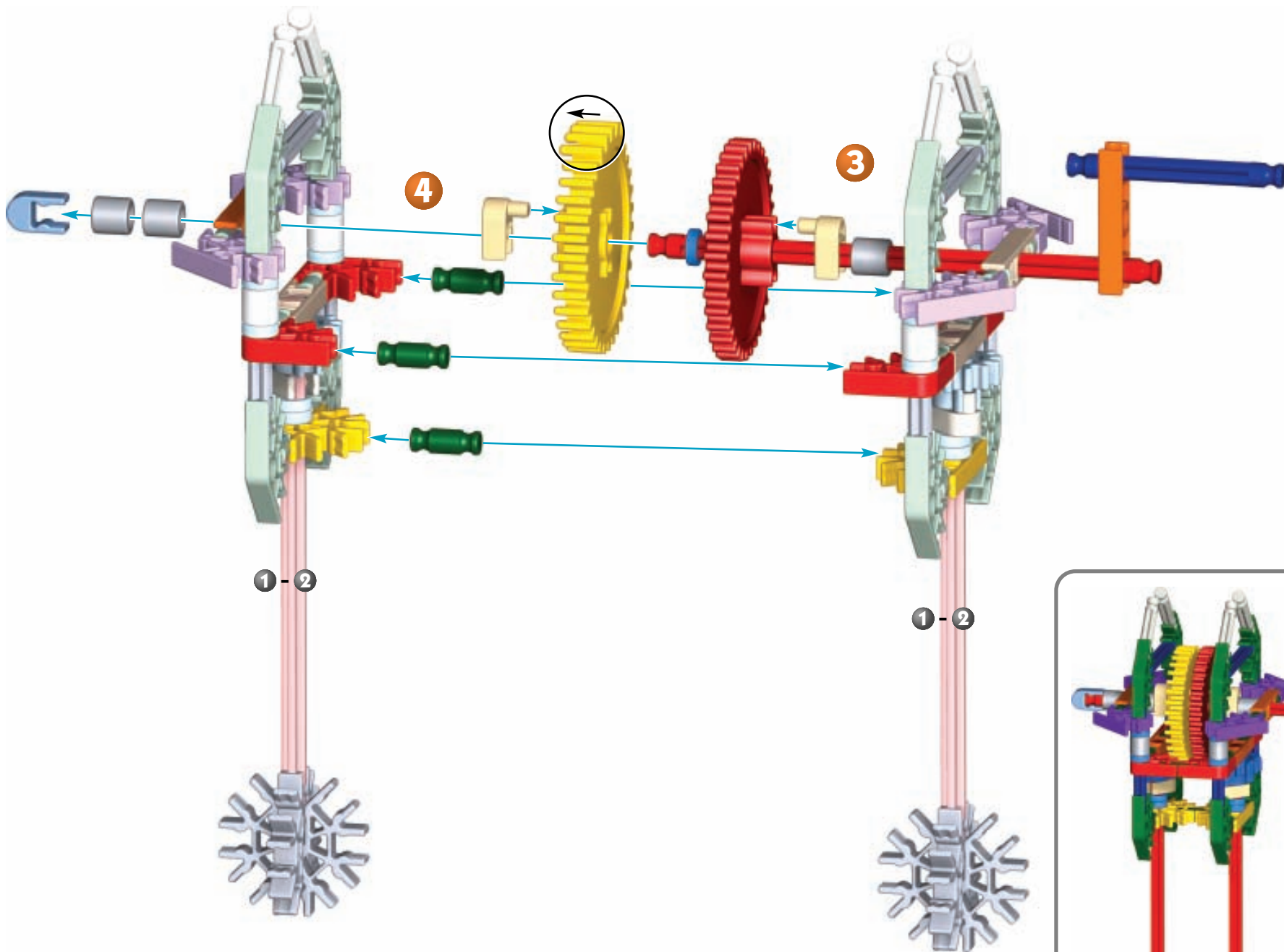

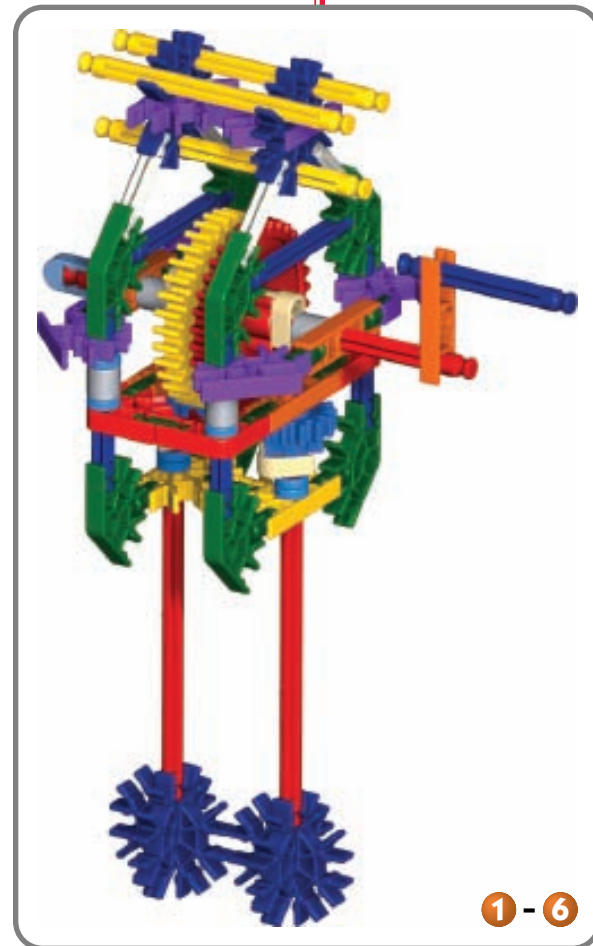
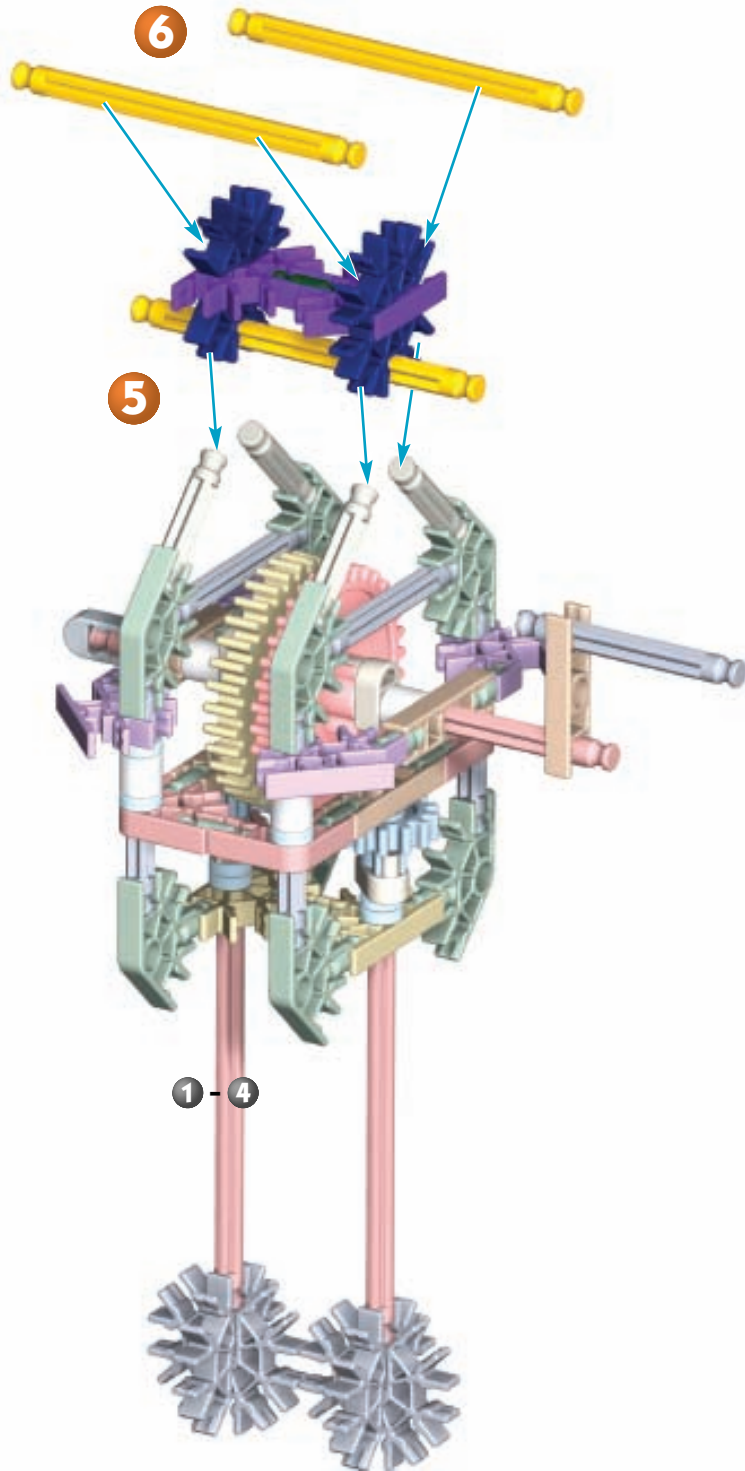

K'NEX

# FLYING MACHINE

GEAR ACTION™

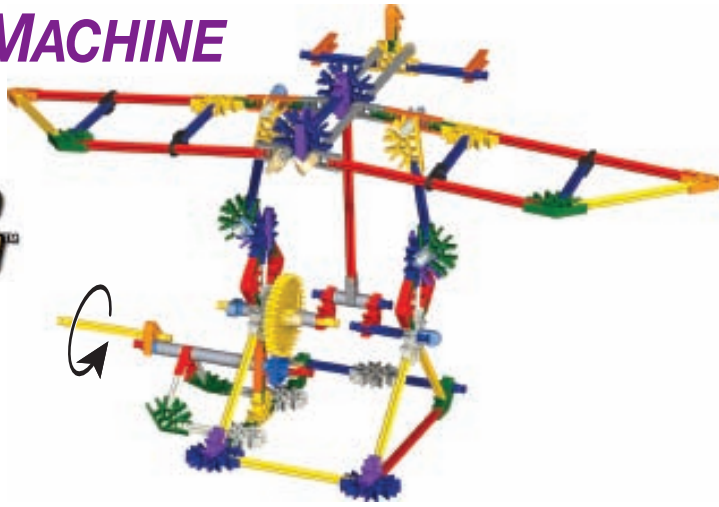

1 - 2

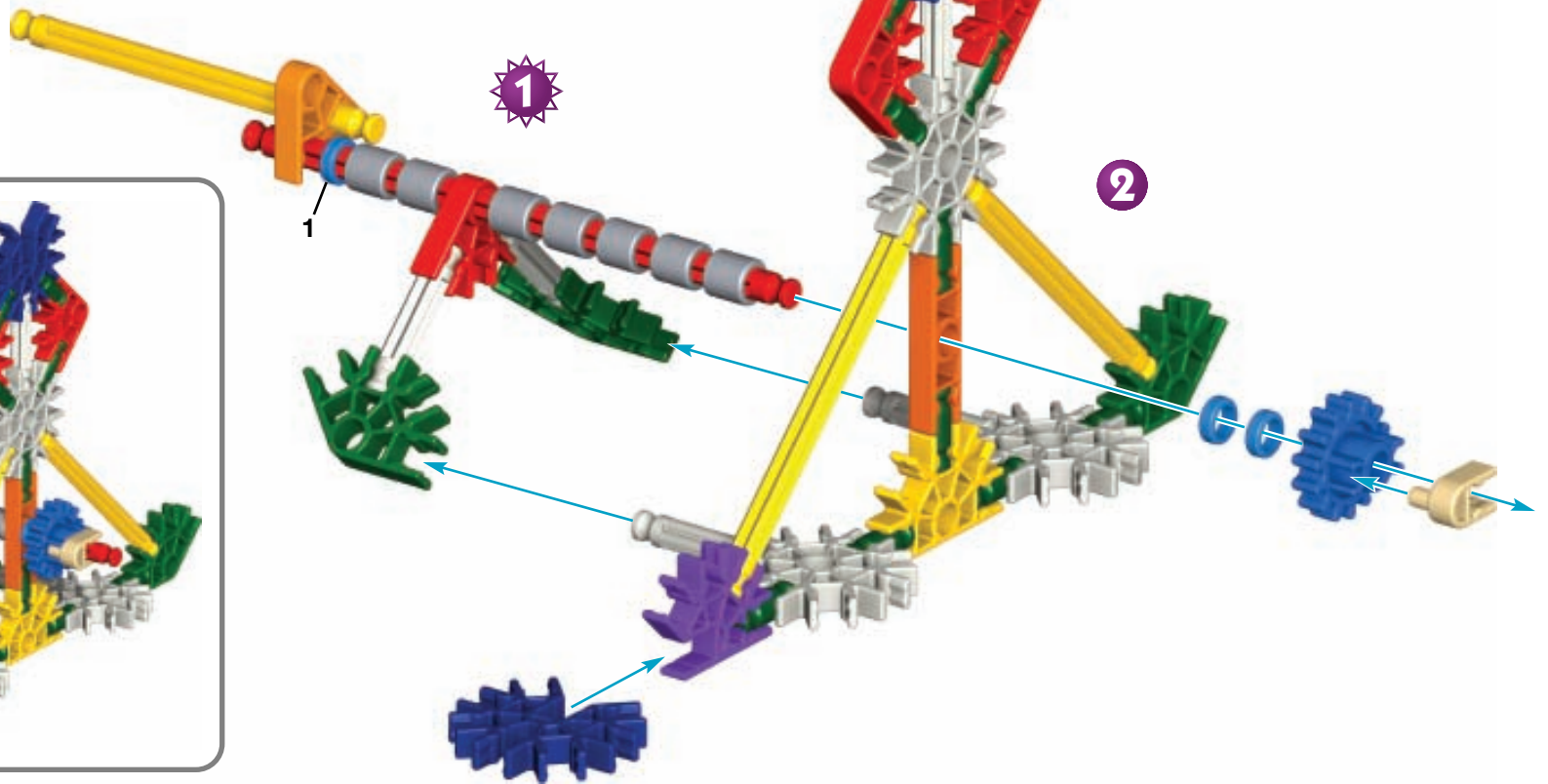

1 FLYING MACHINE

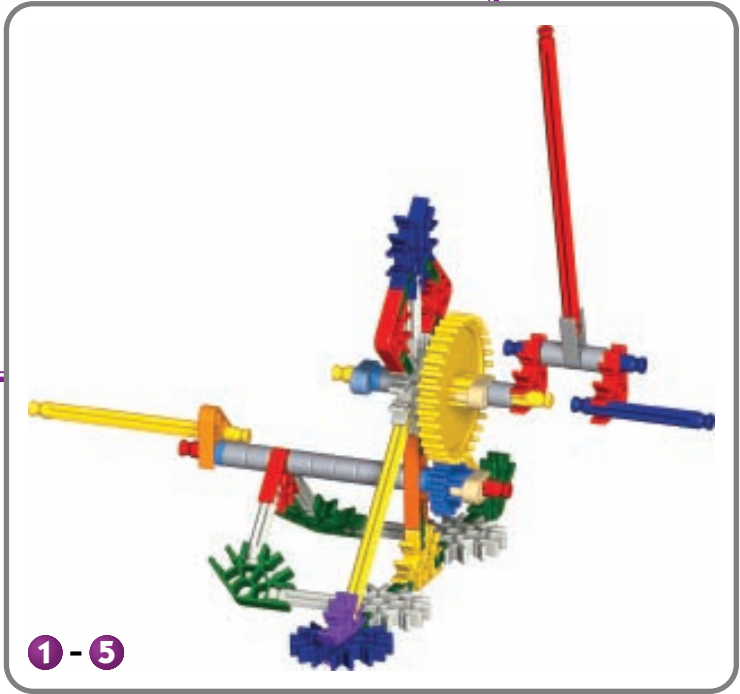
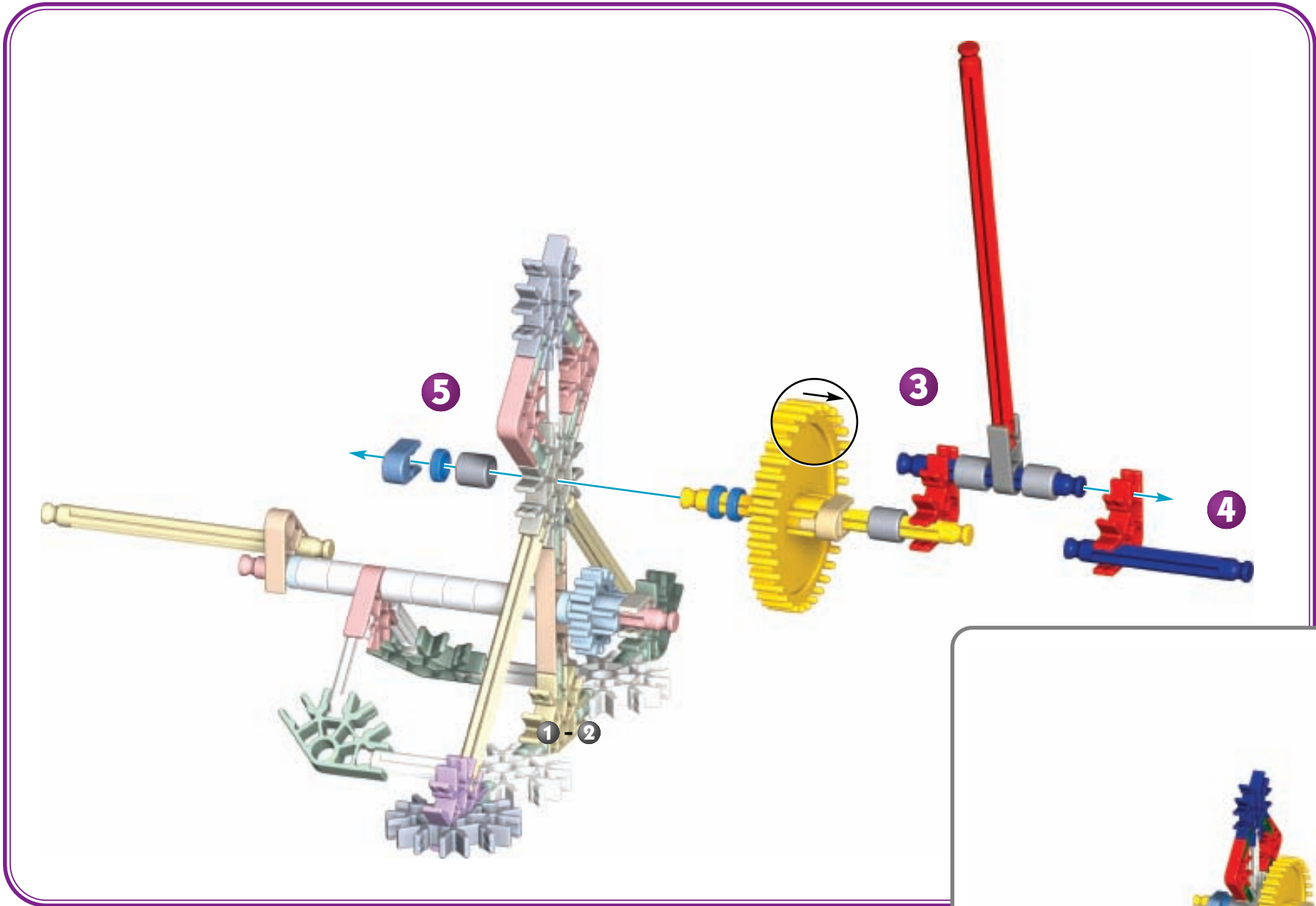





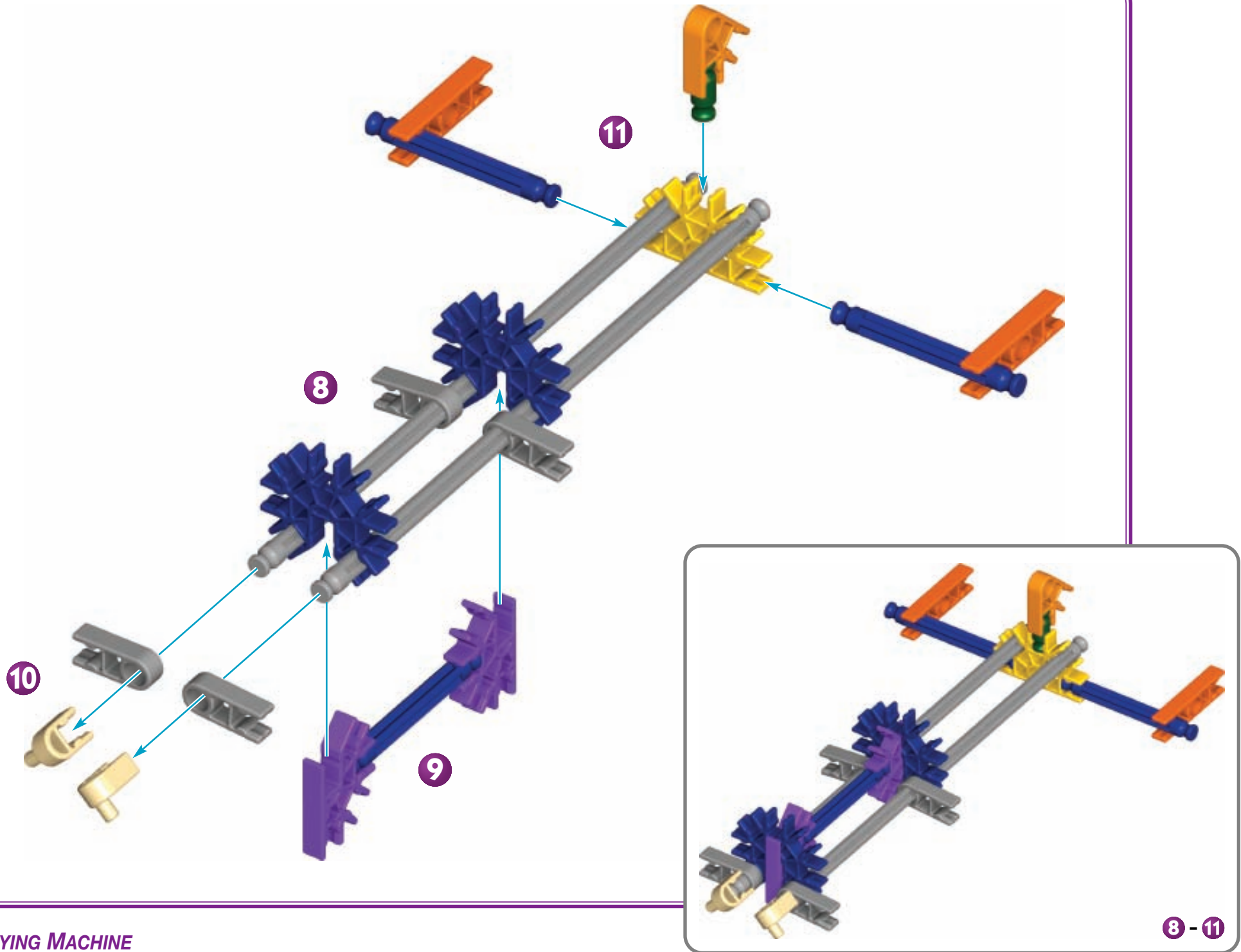

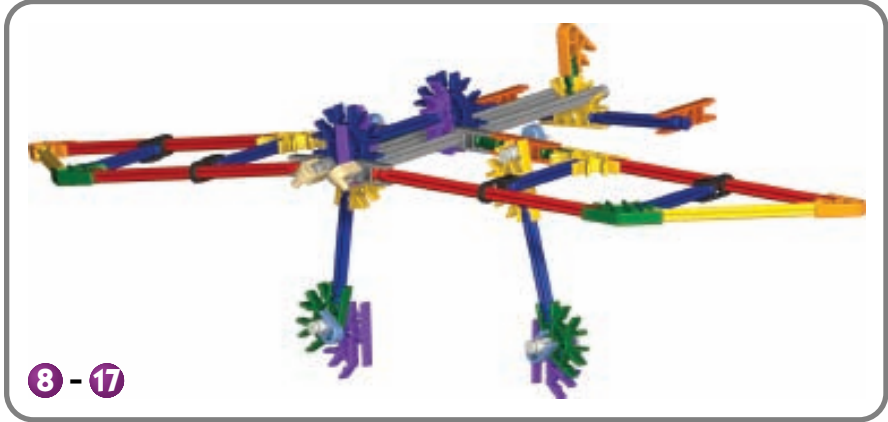
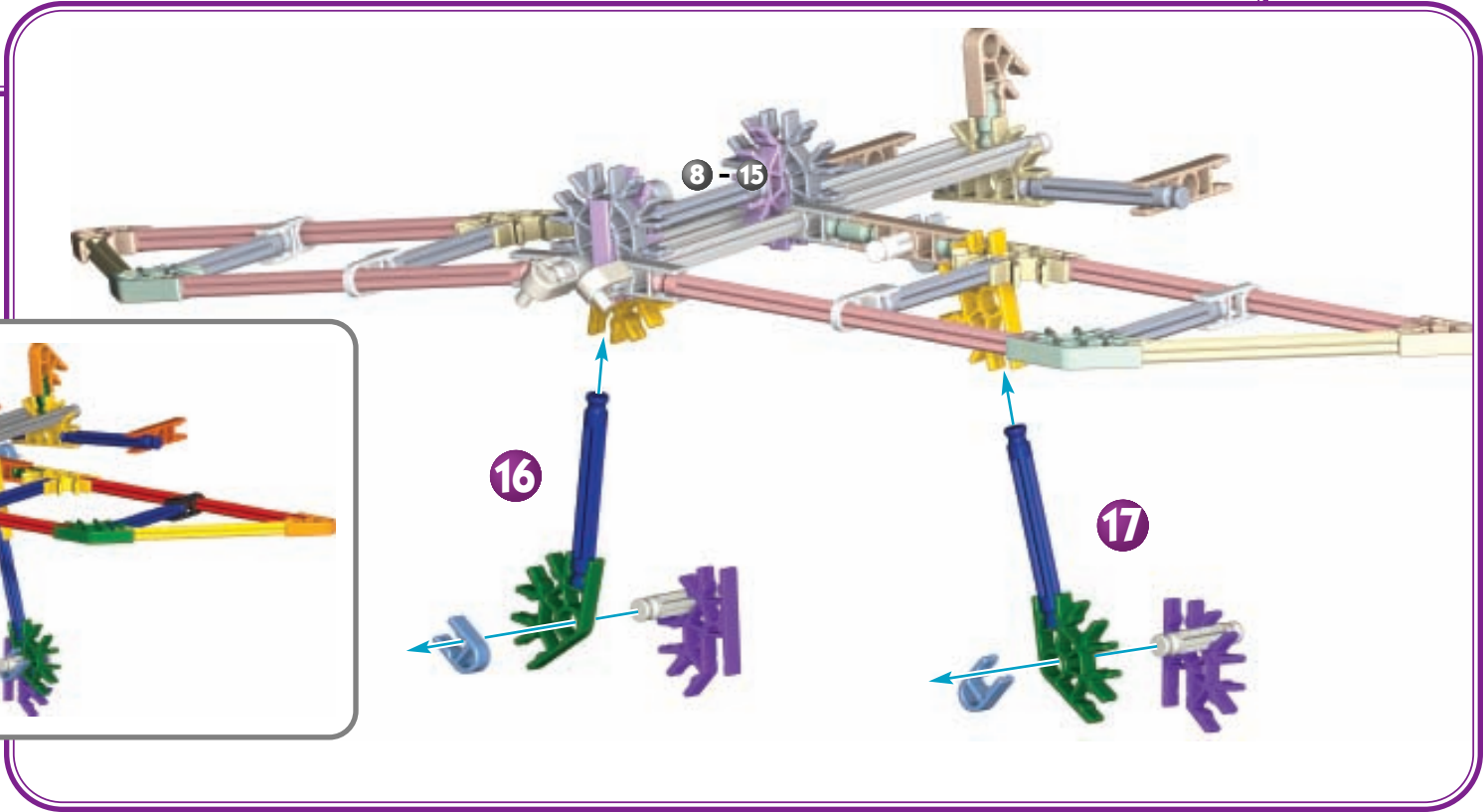
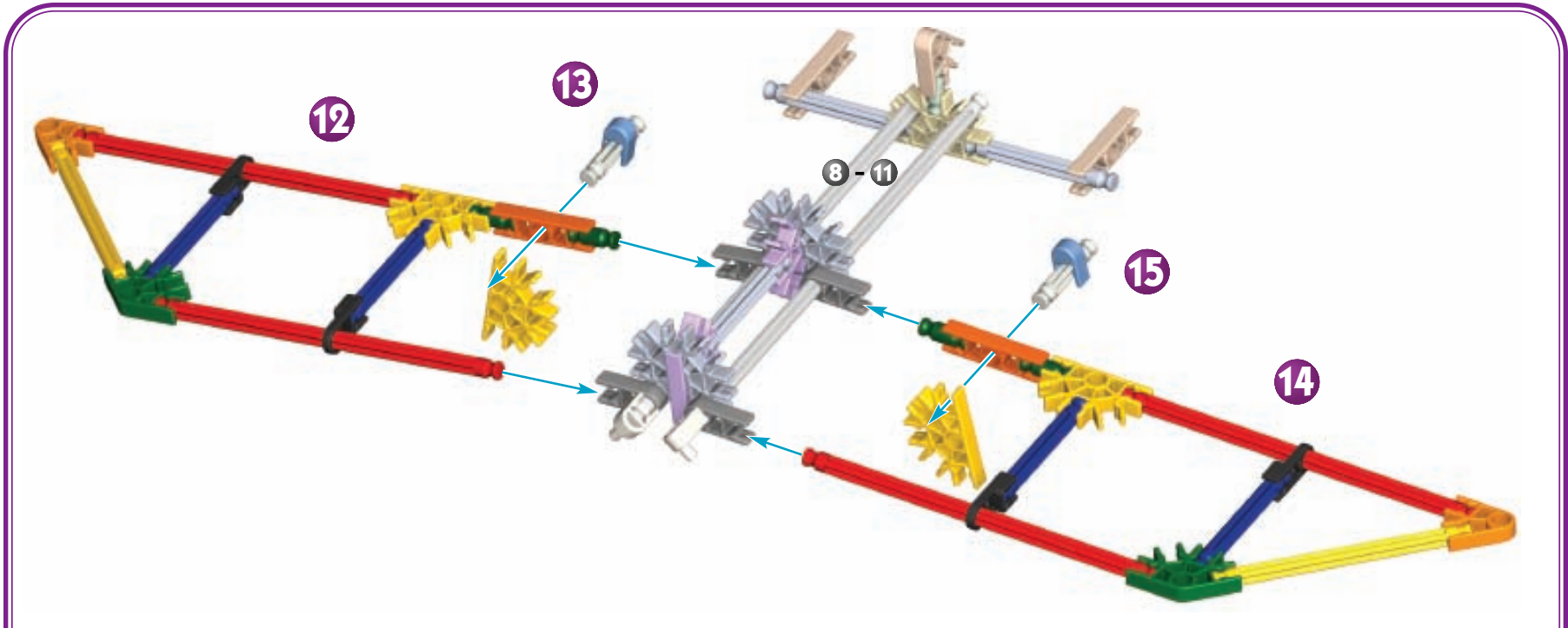

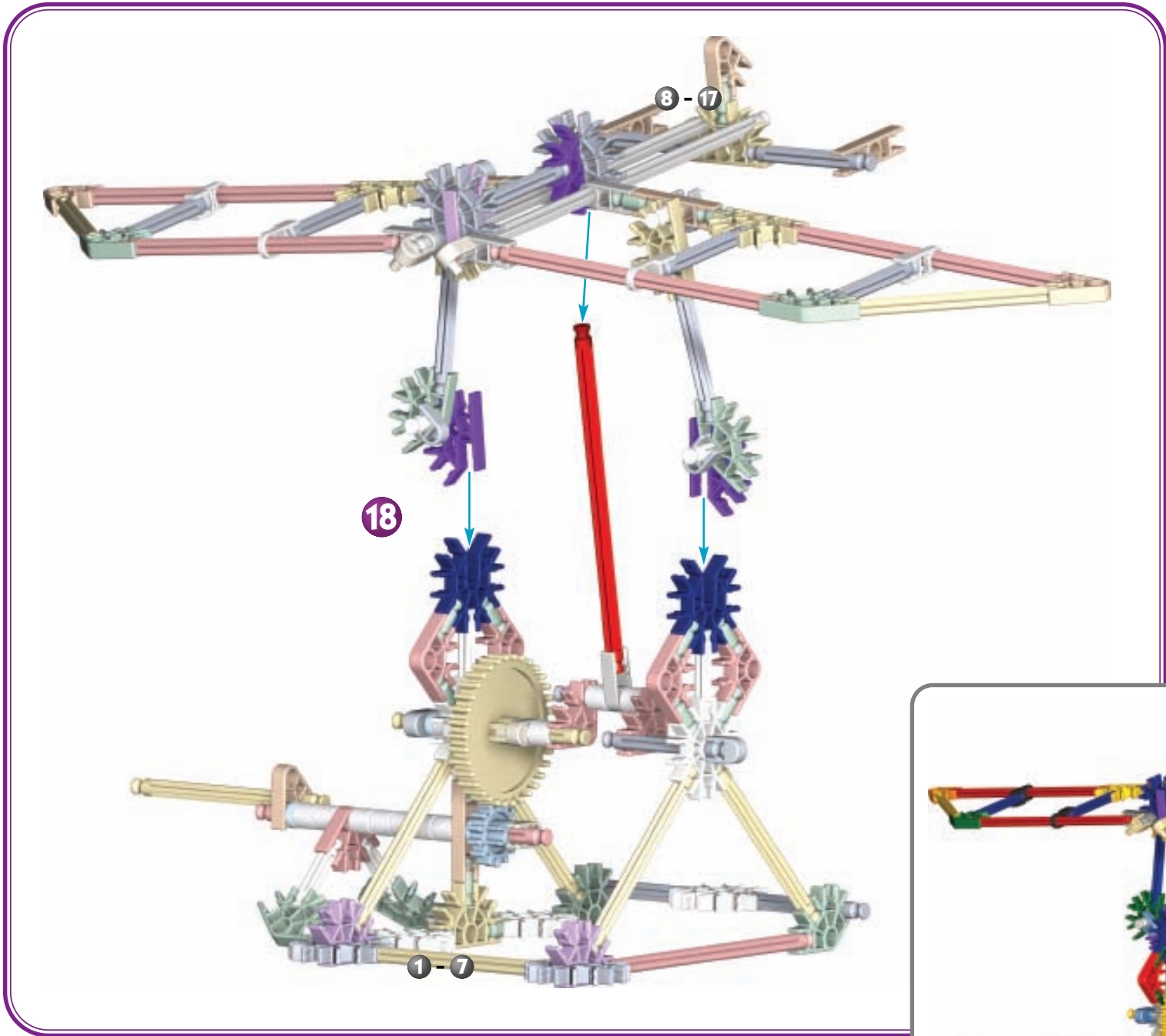

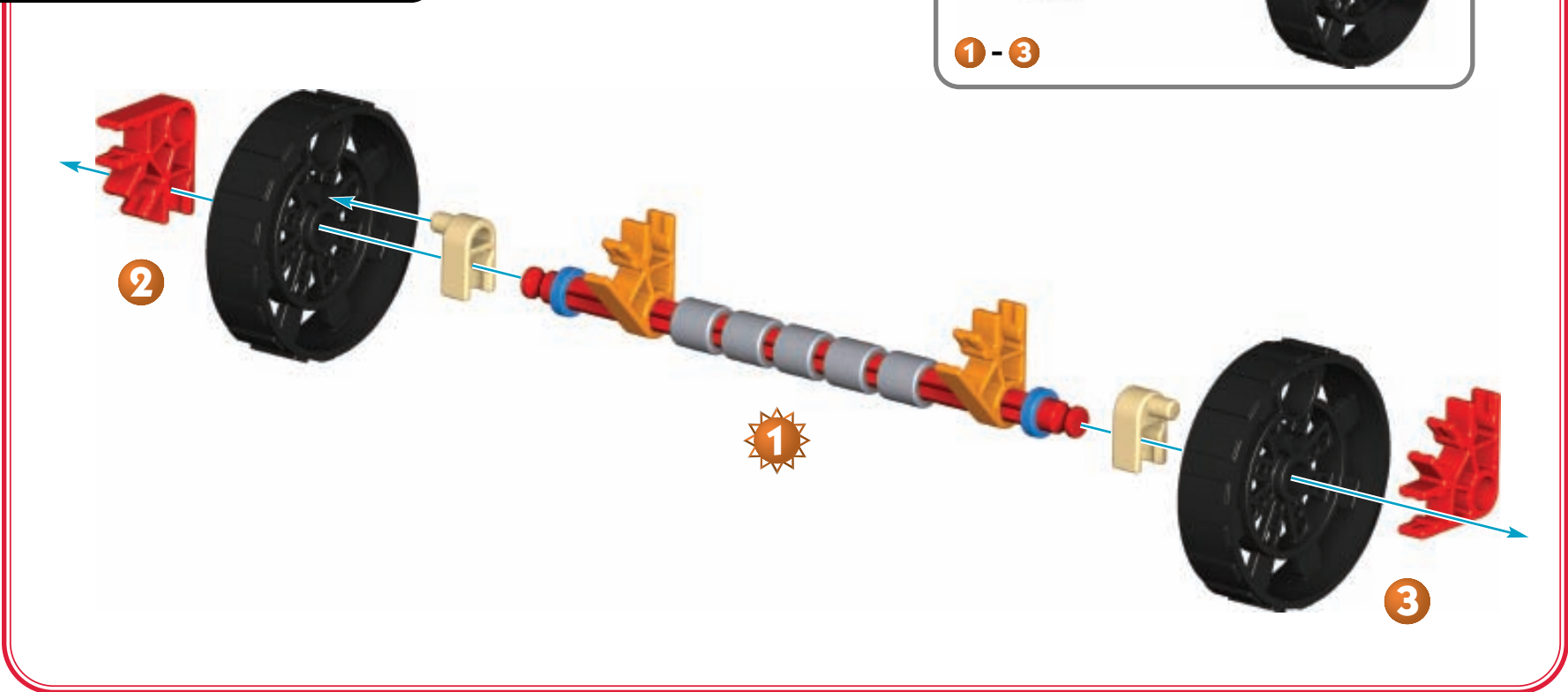
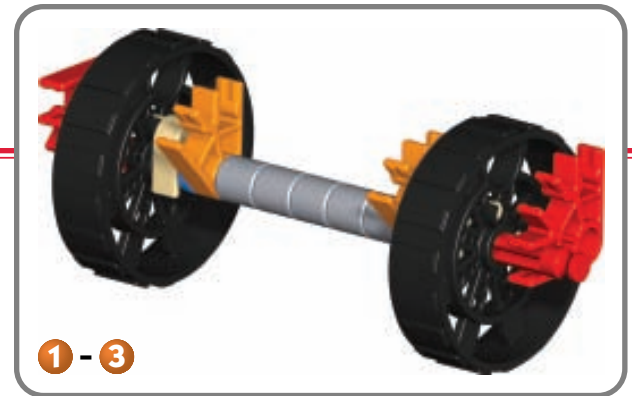

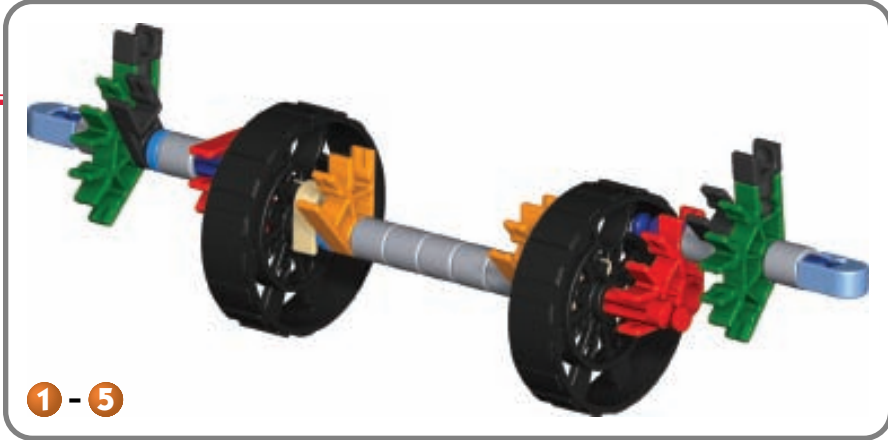
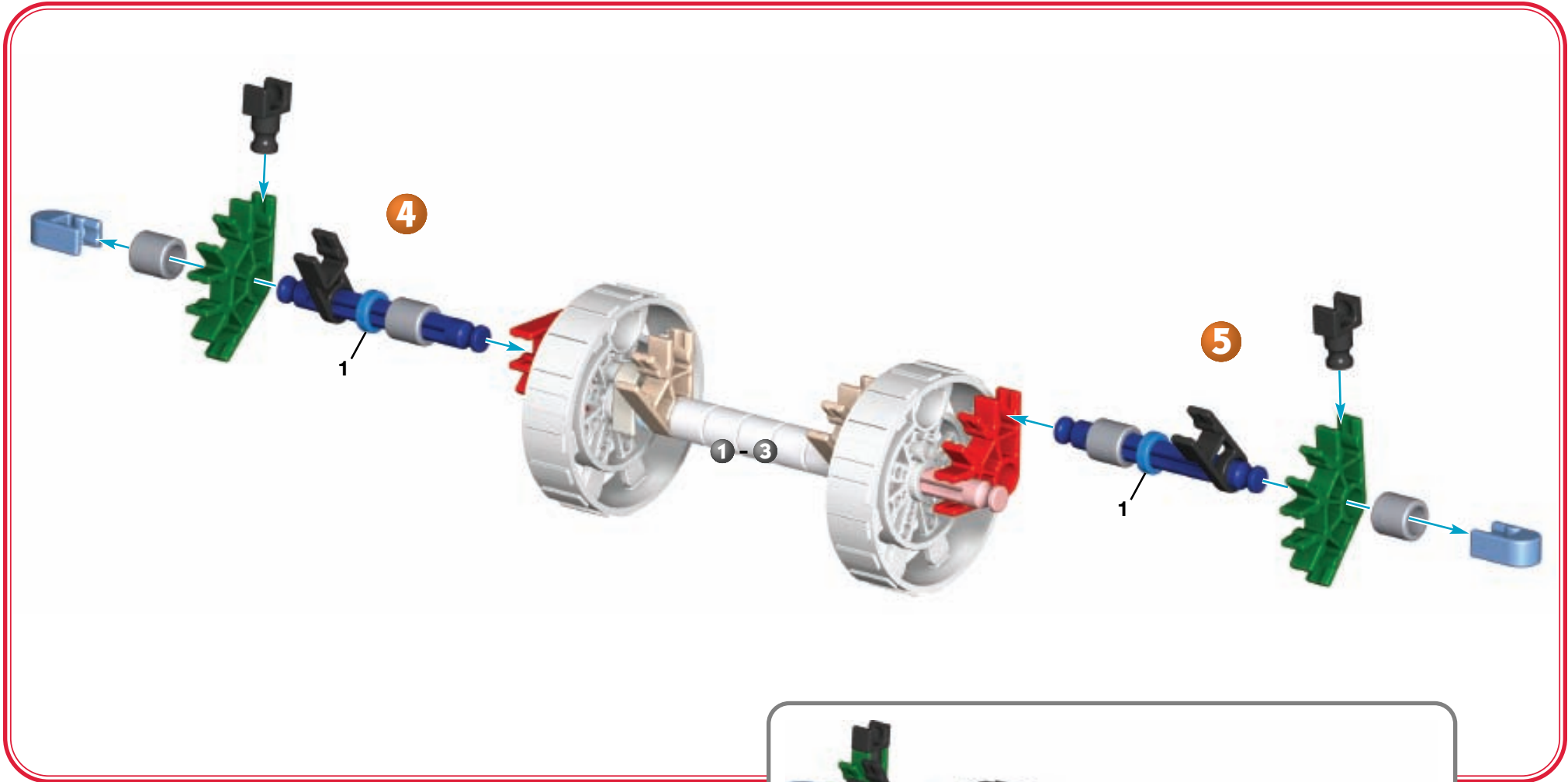

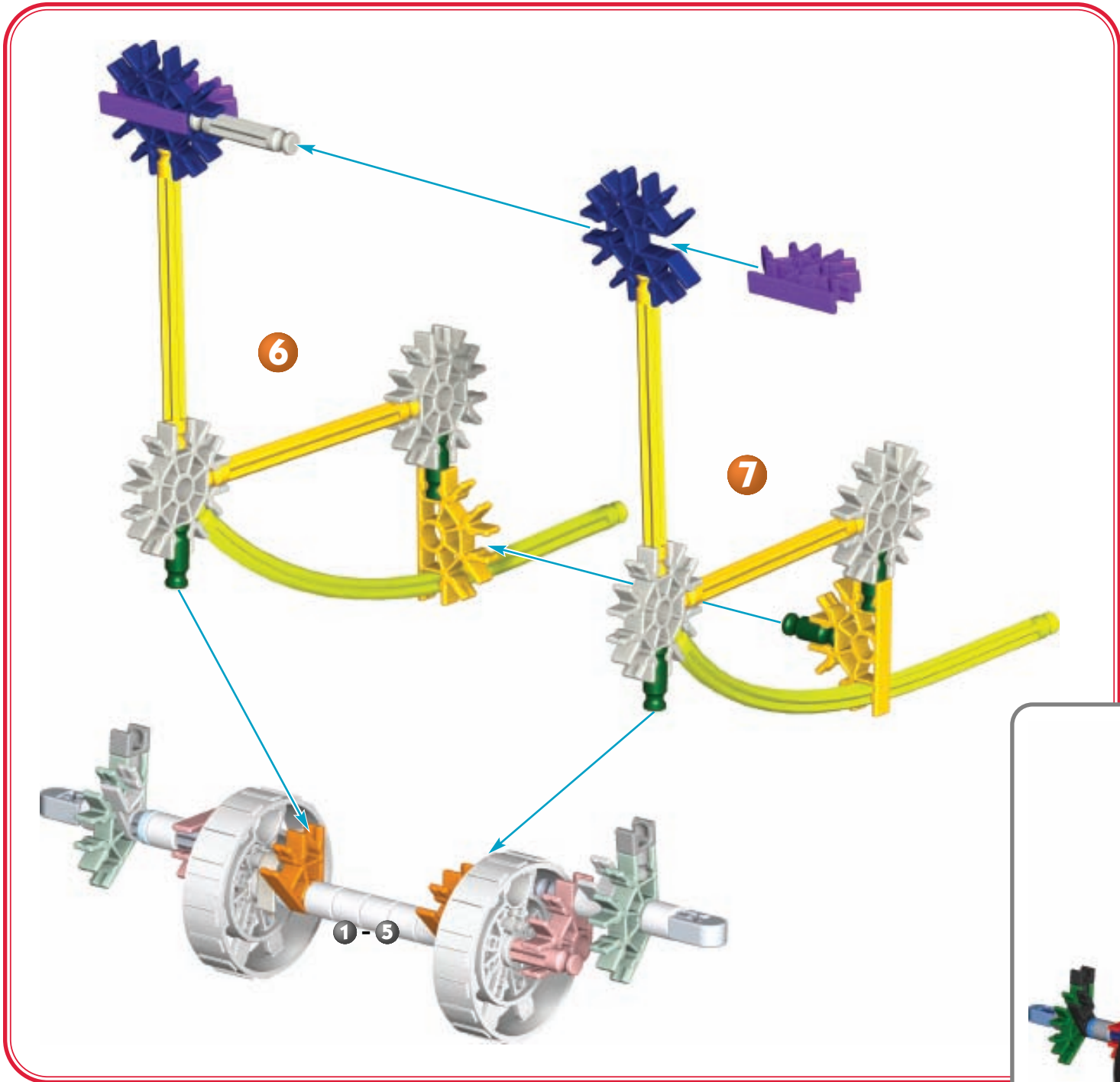

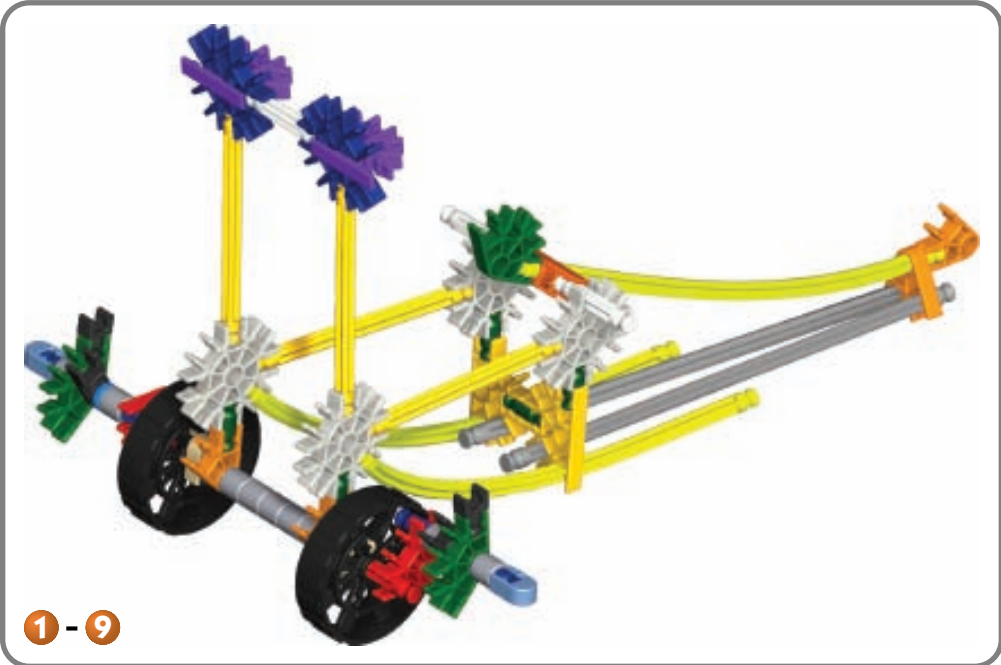
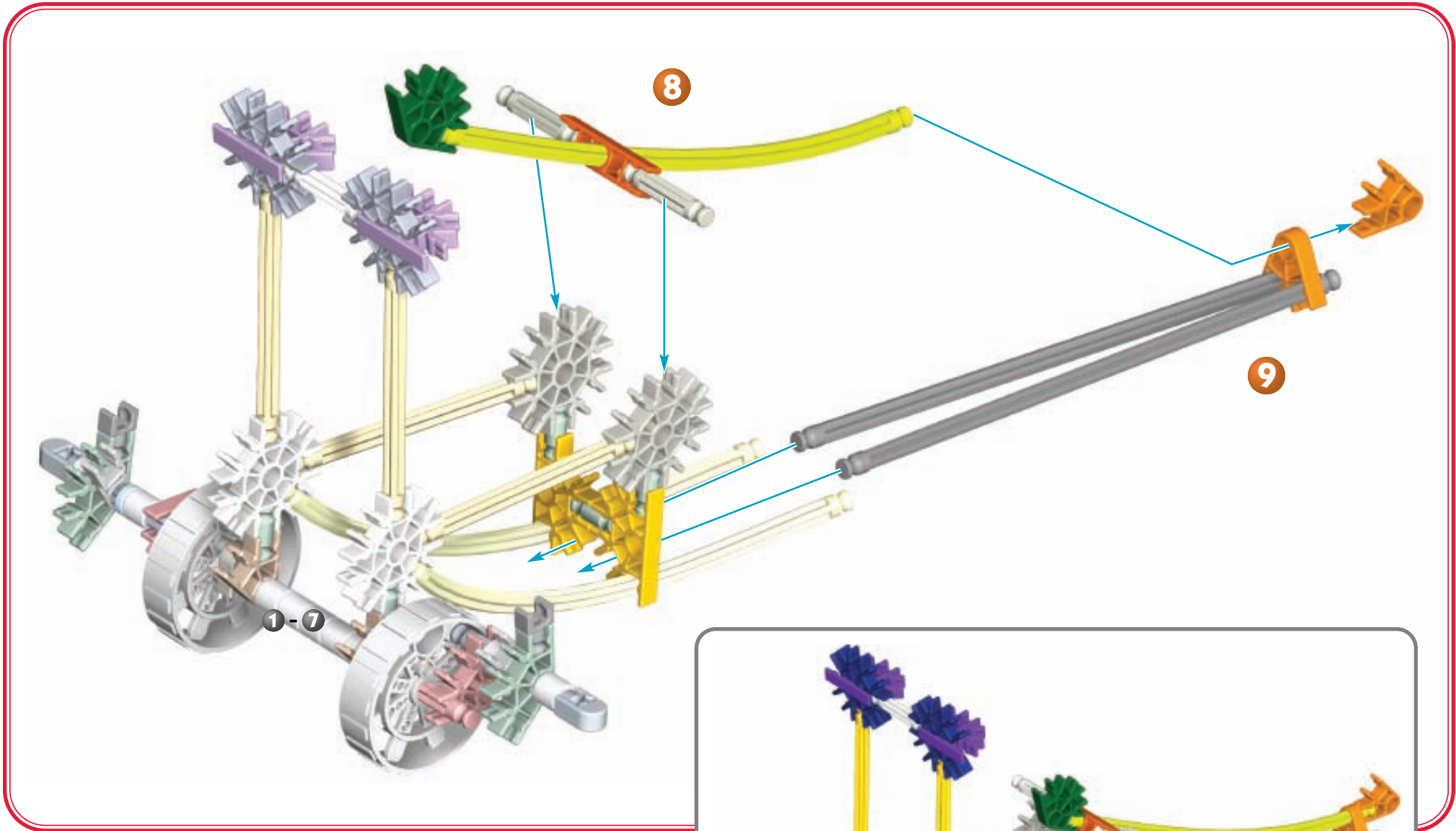



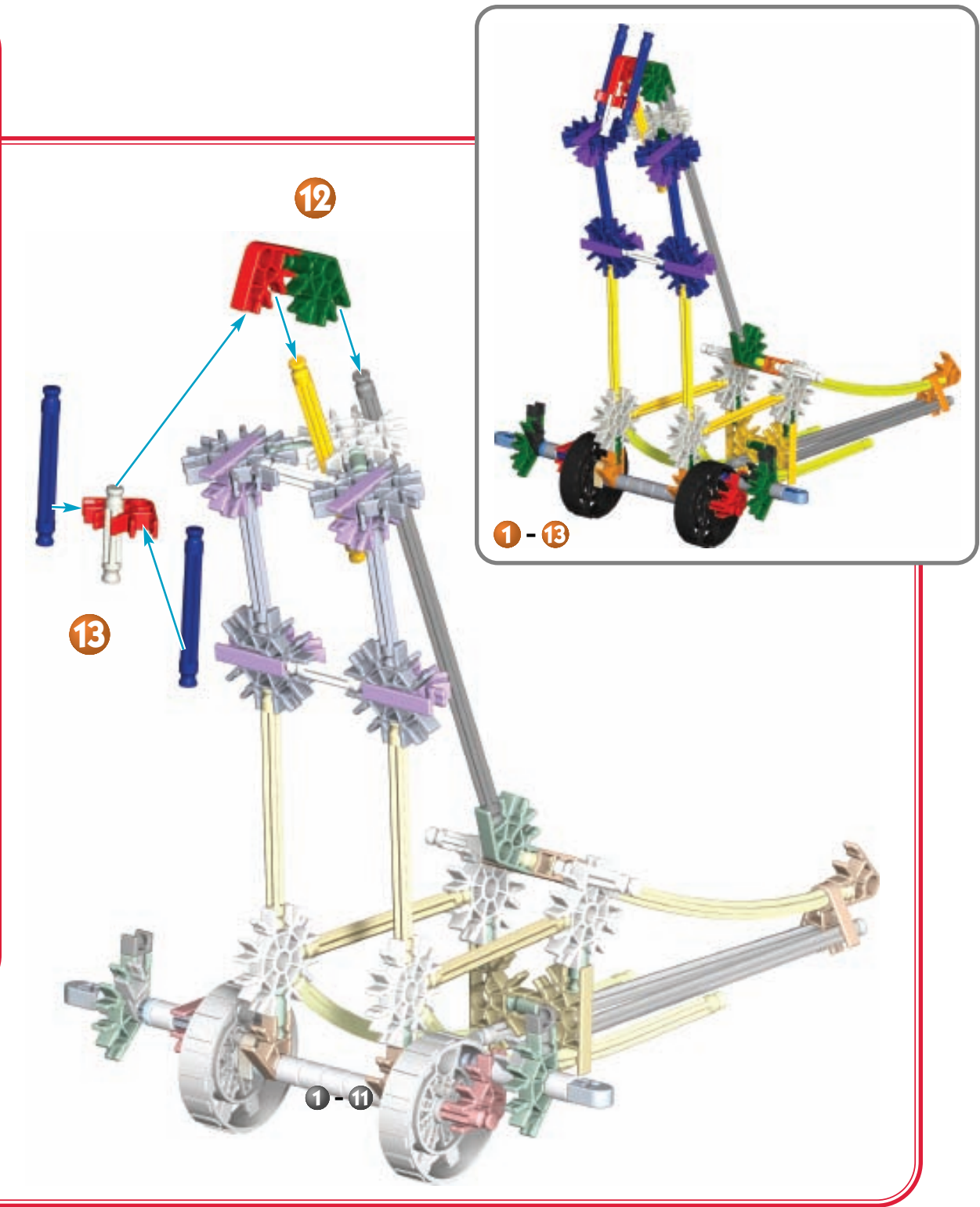
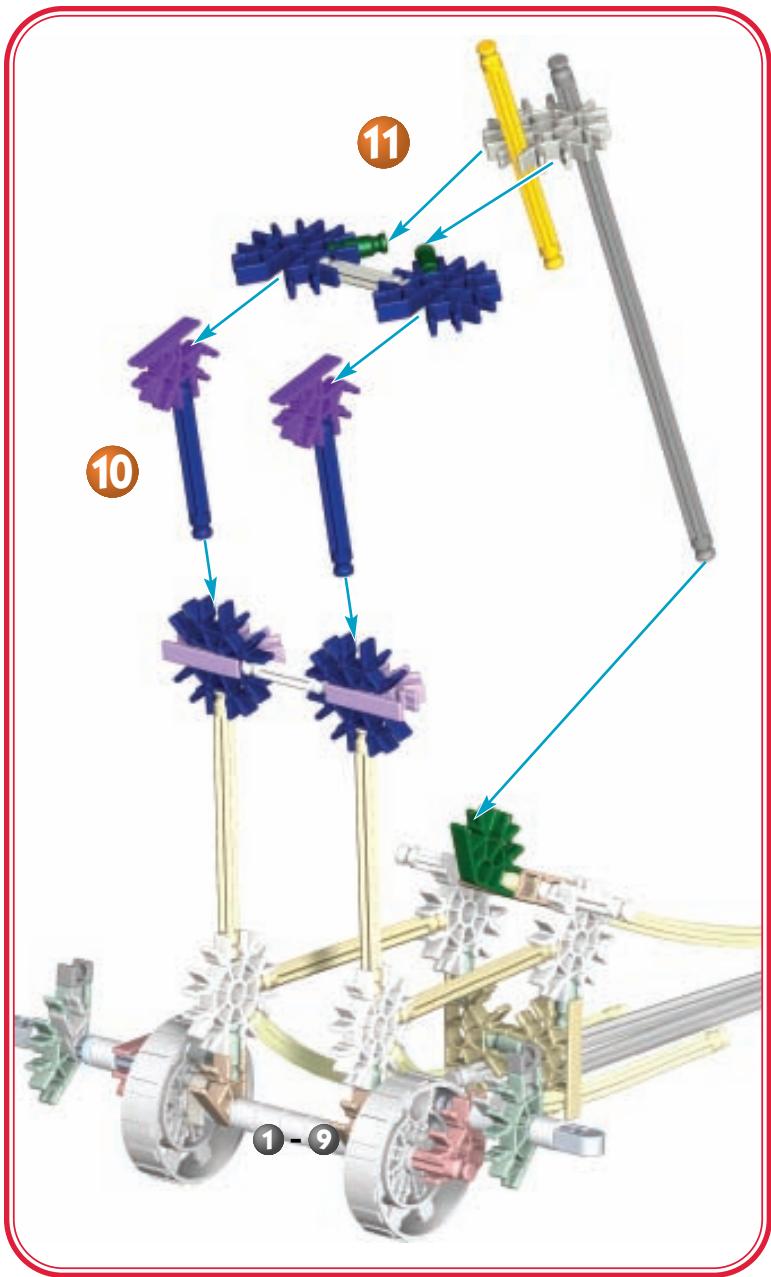

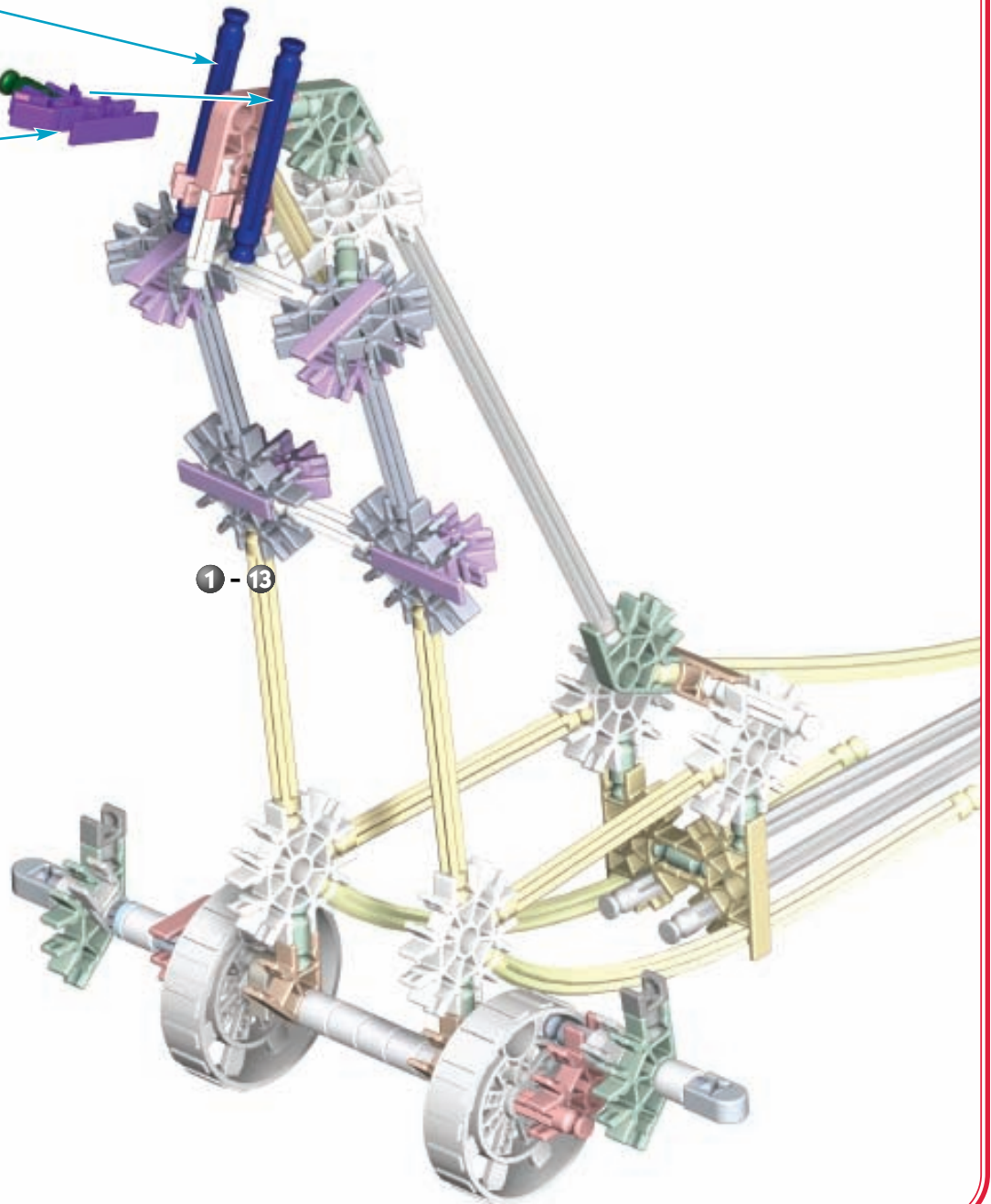
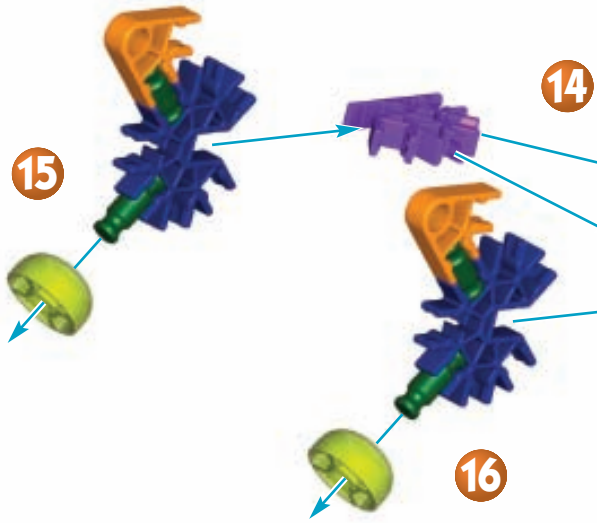

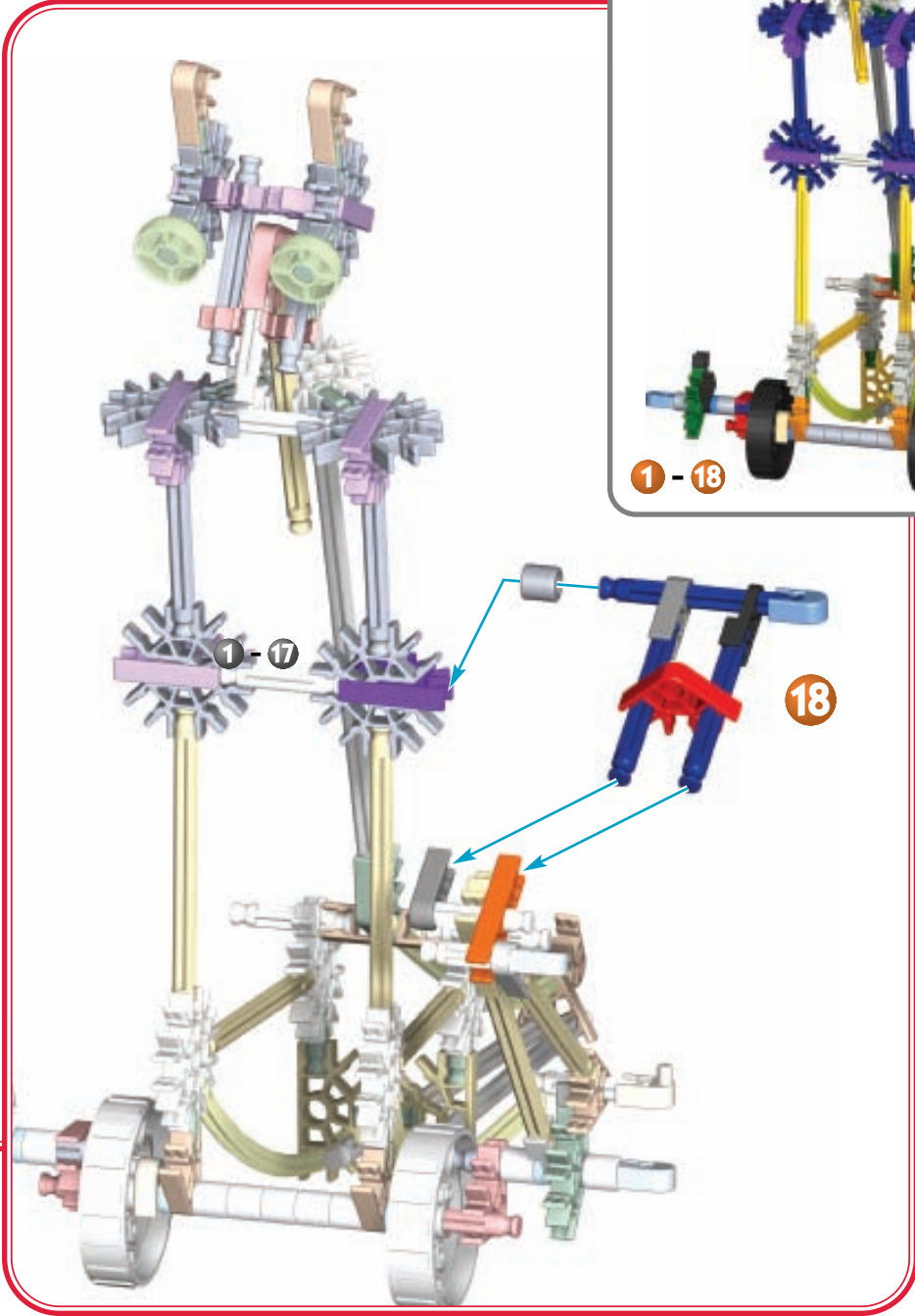
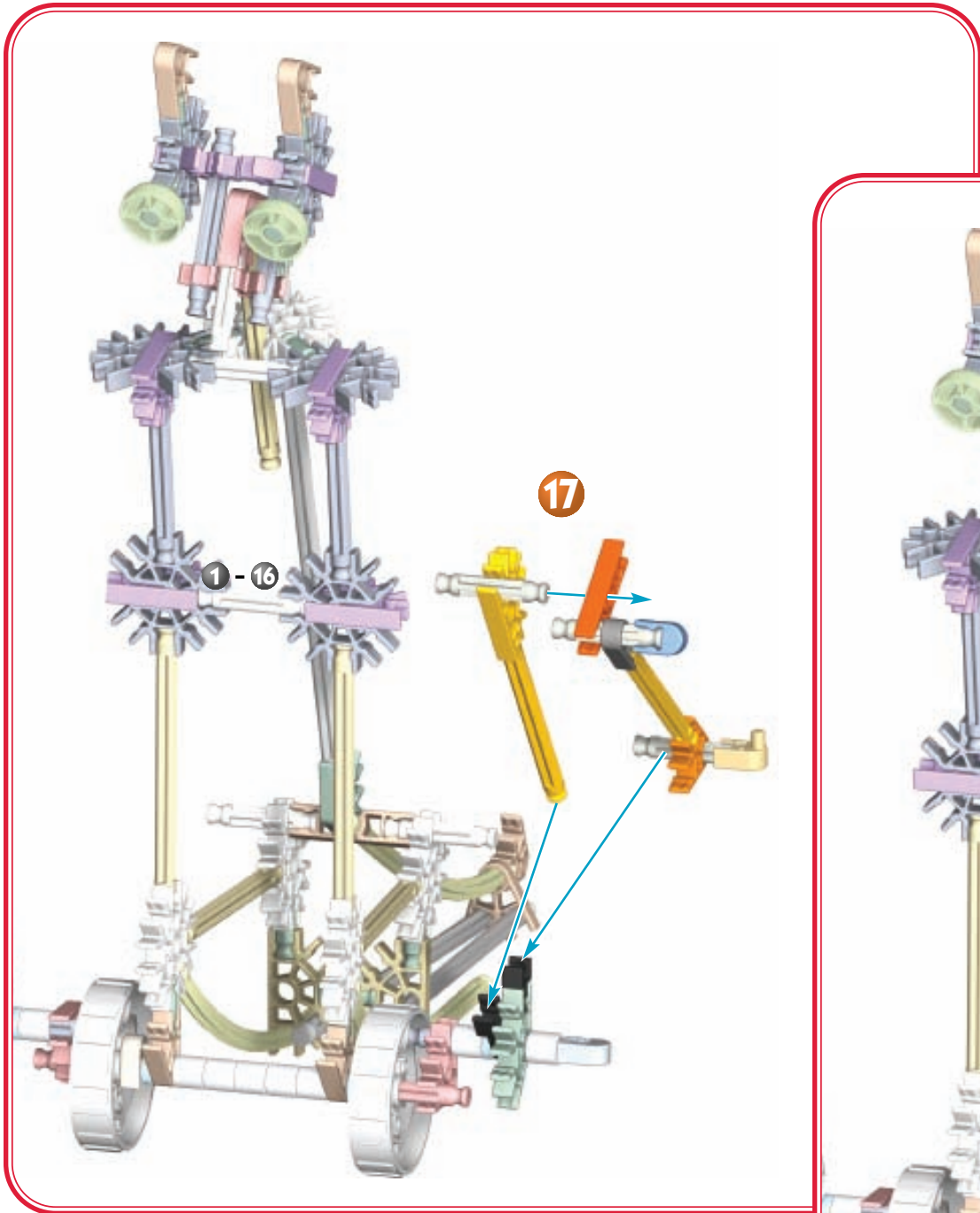

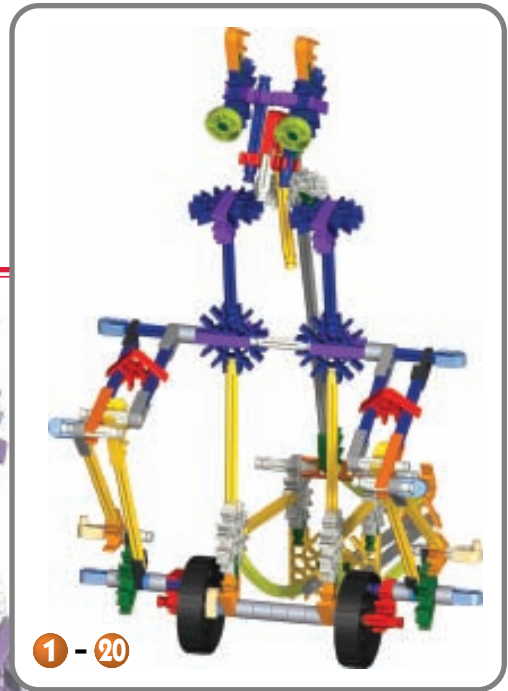
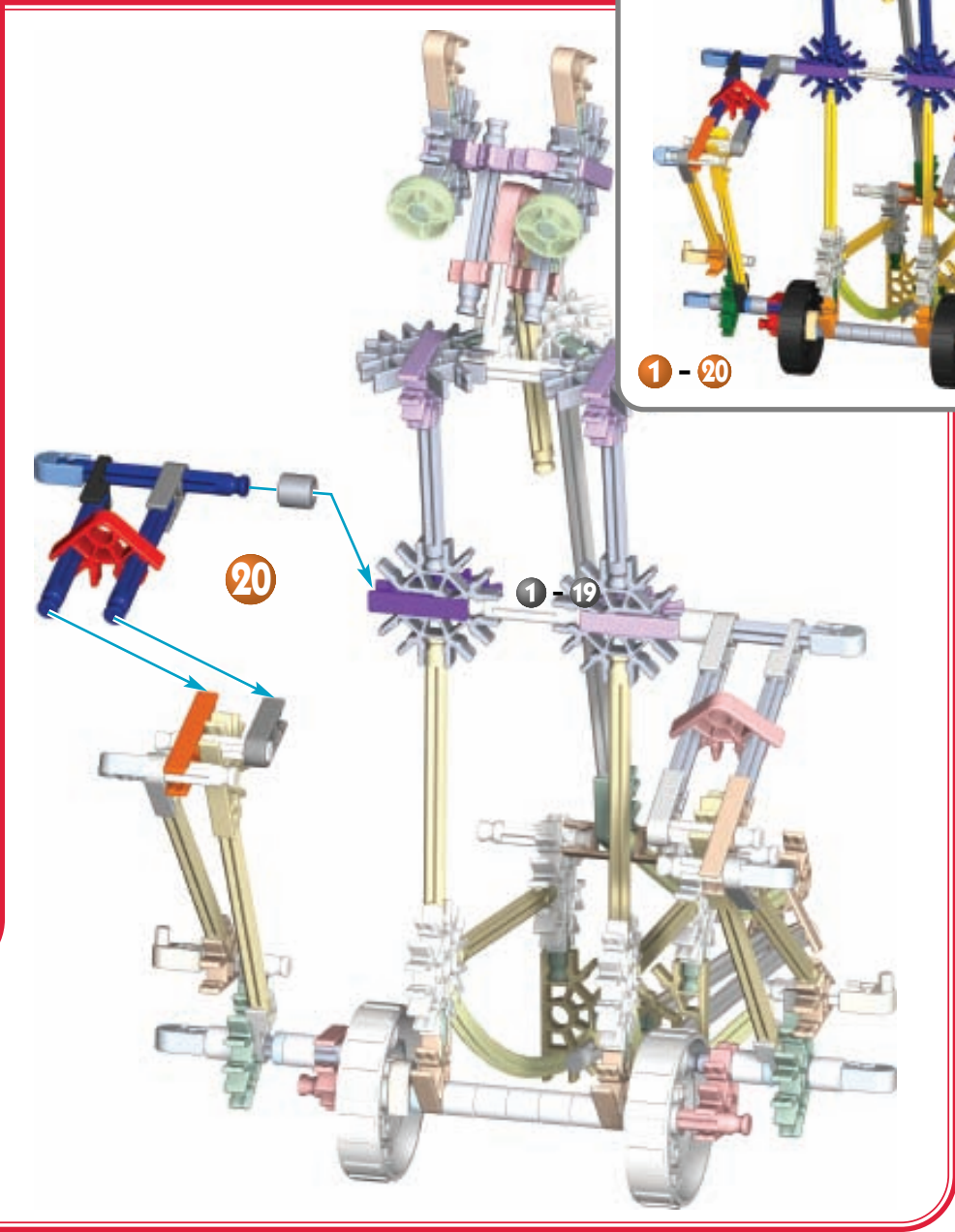

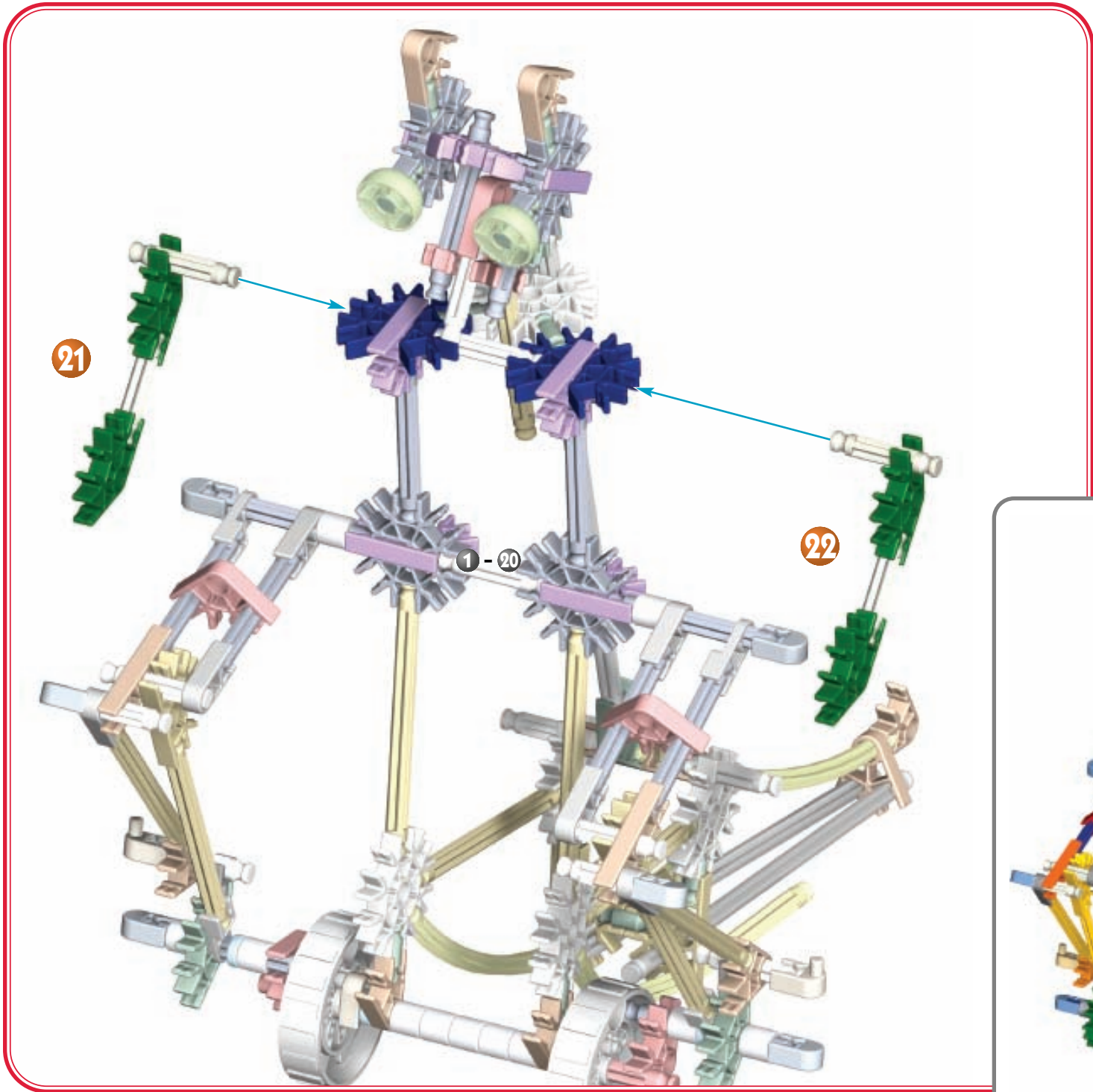

K'NEX

# RADAR ANTENNA ROTOR

GEAR  
ACTION™



1

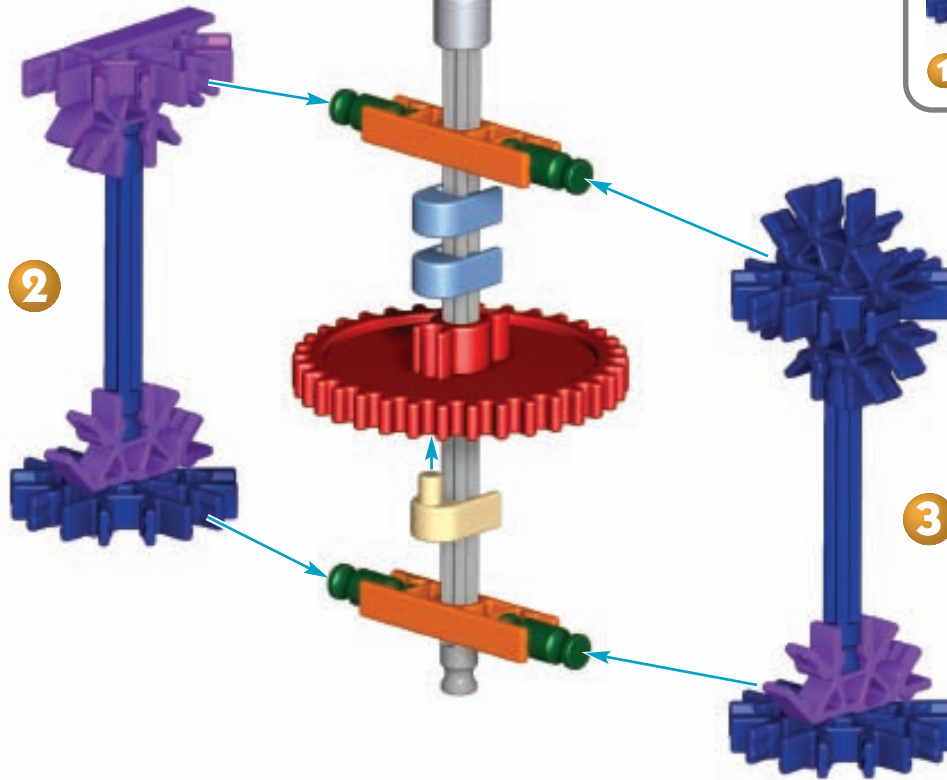



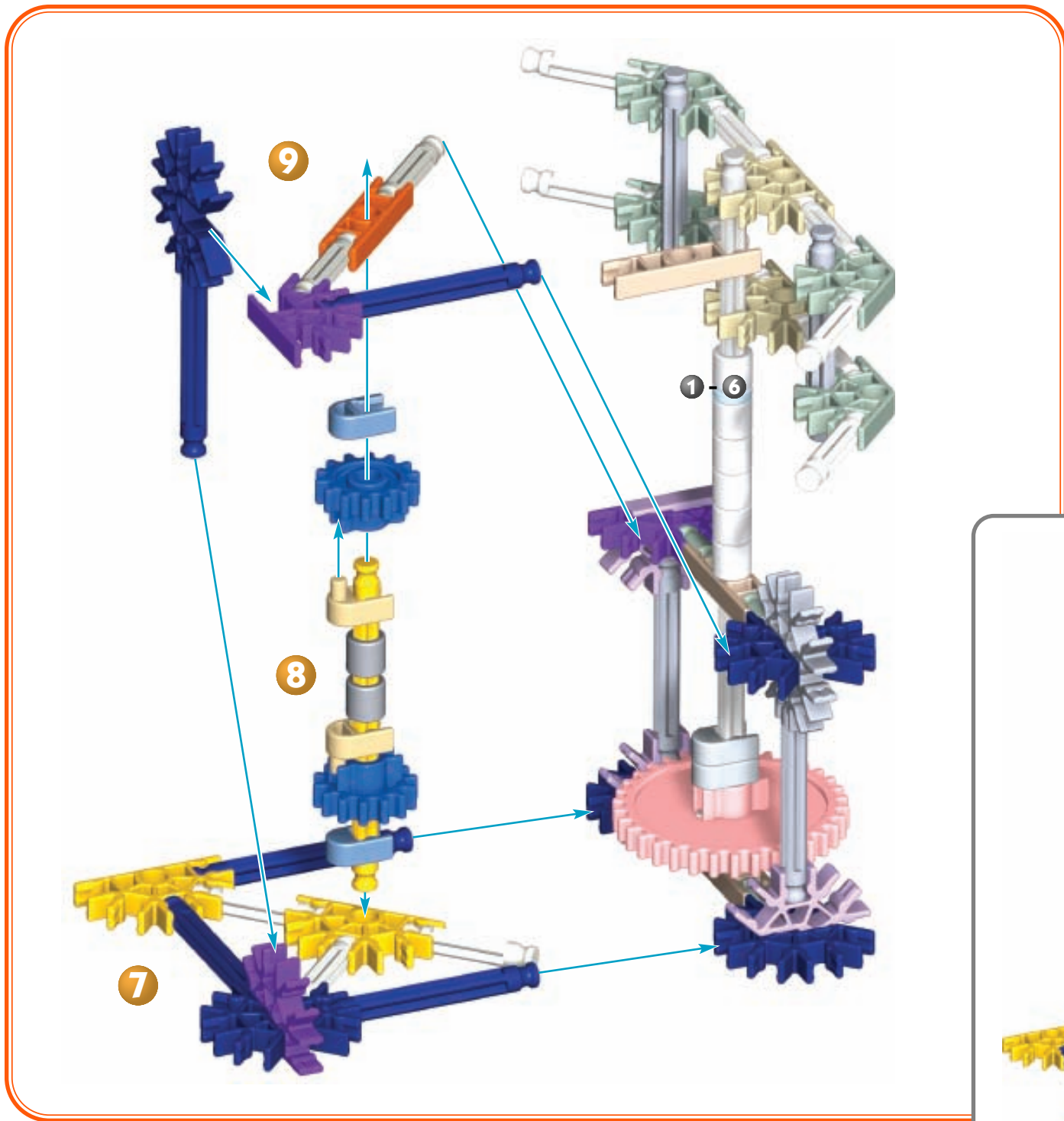



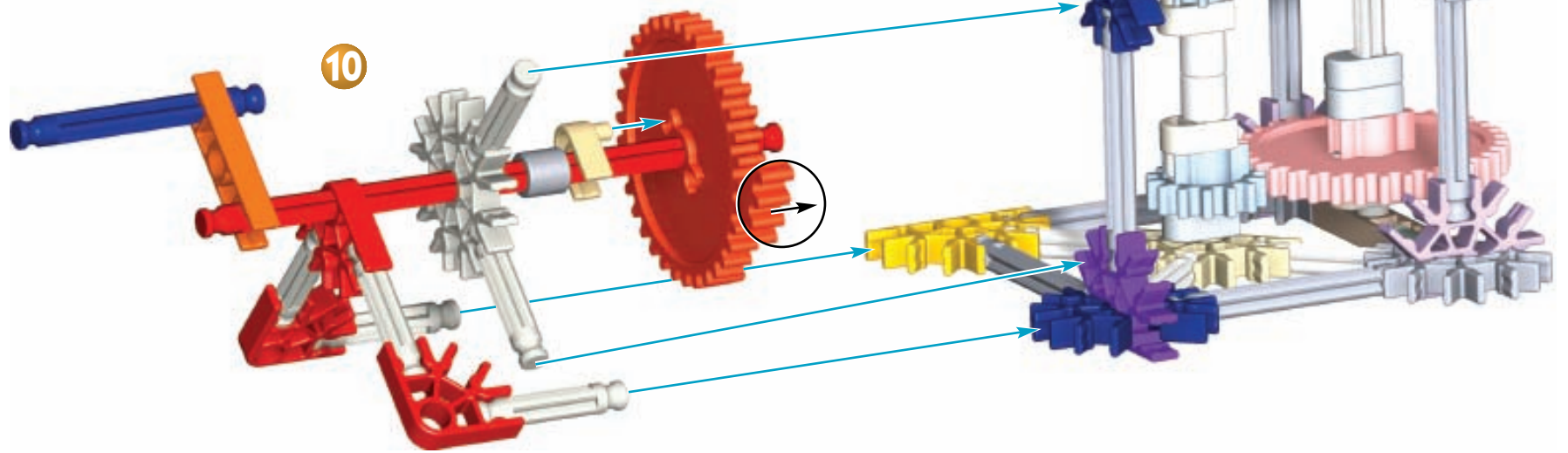
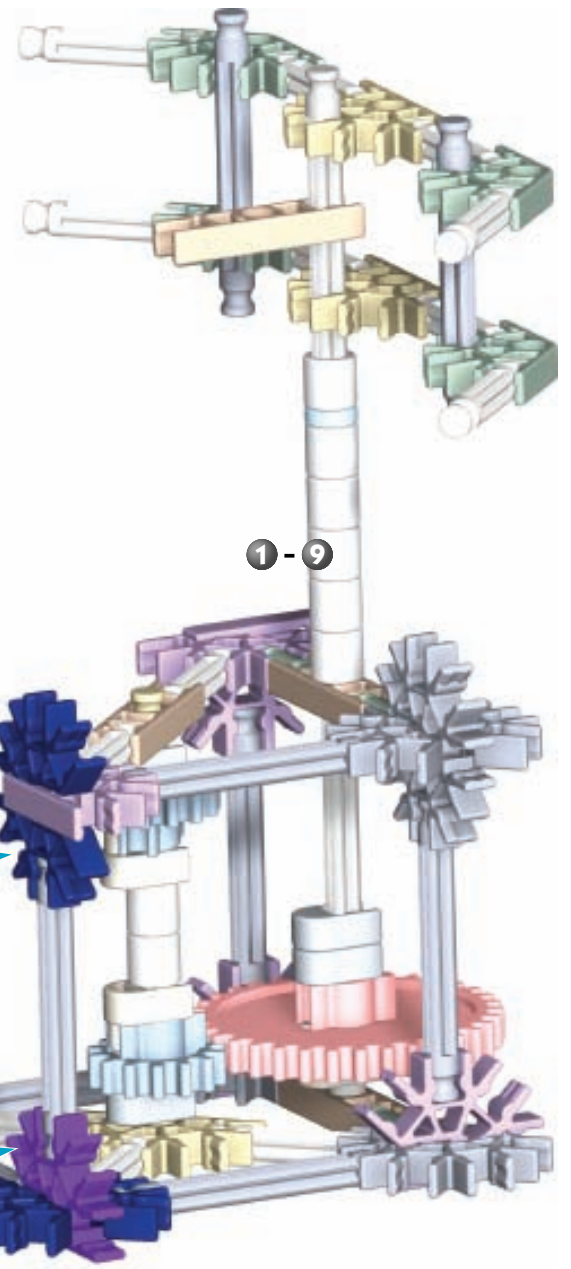

K'nex

# RAILROAD PUMP CAR

GEAR ACTION™



2

1

3

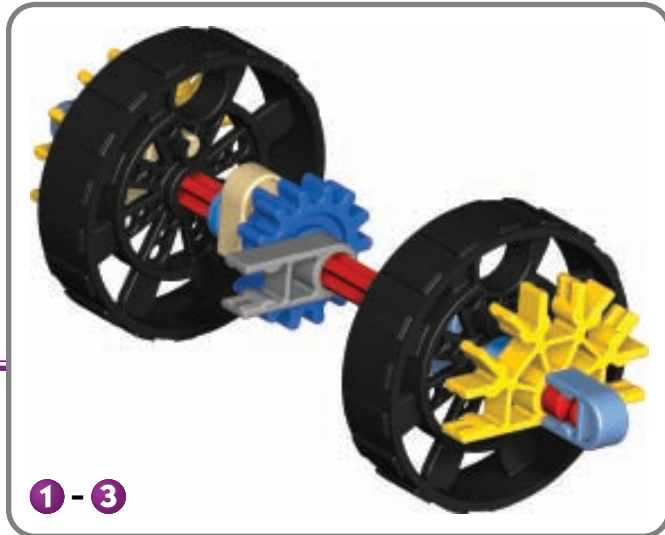

1 - 3

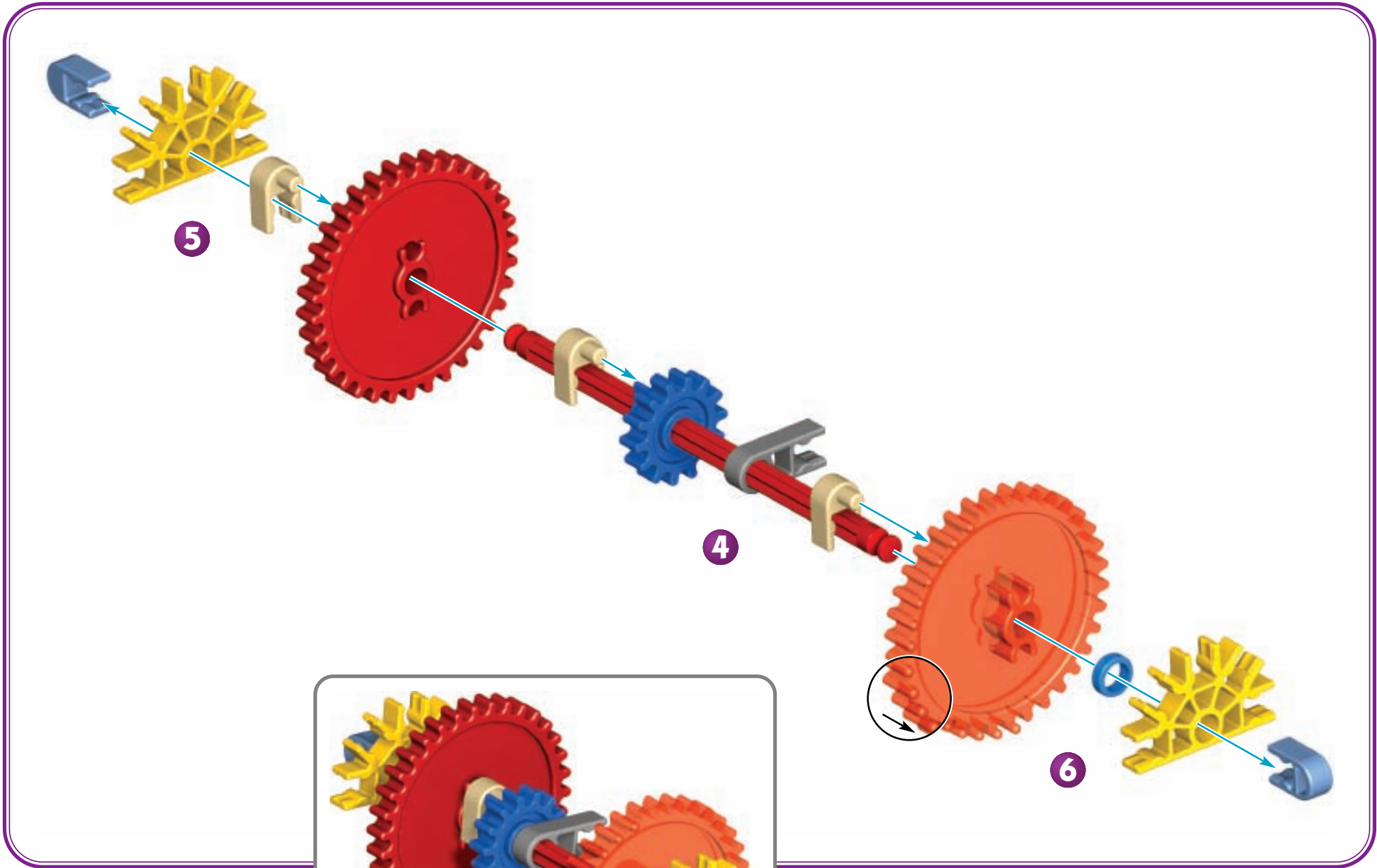

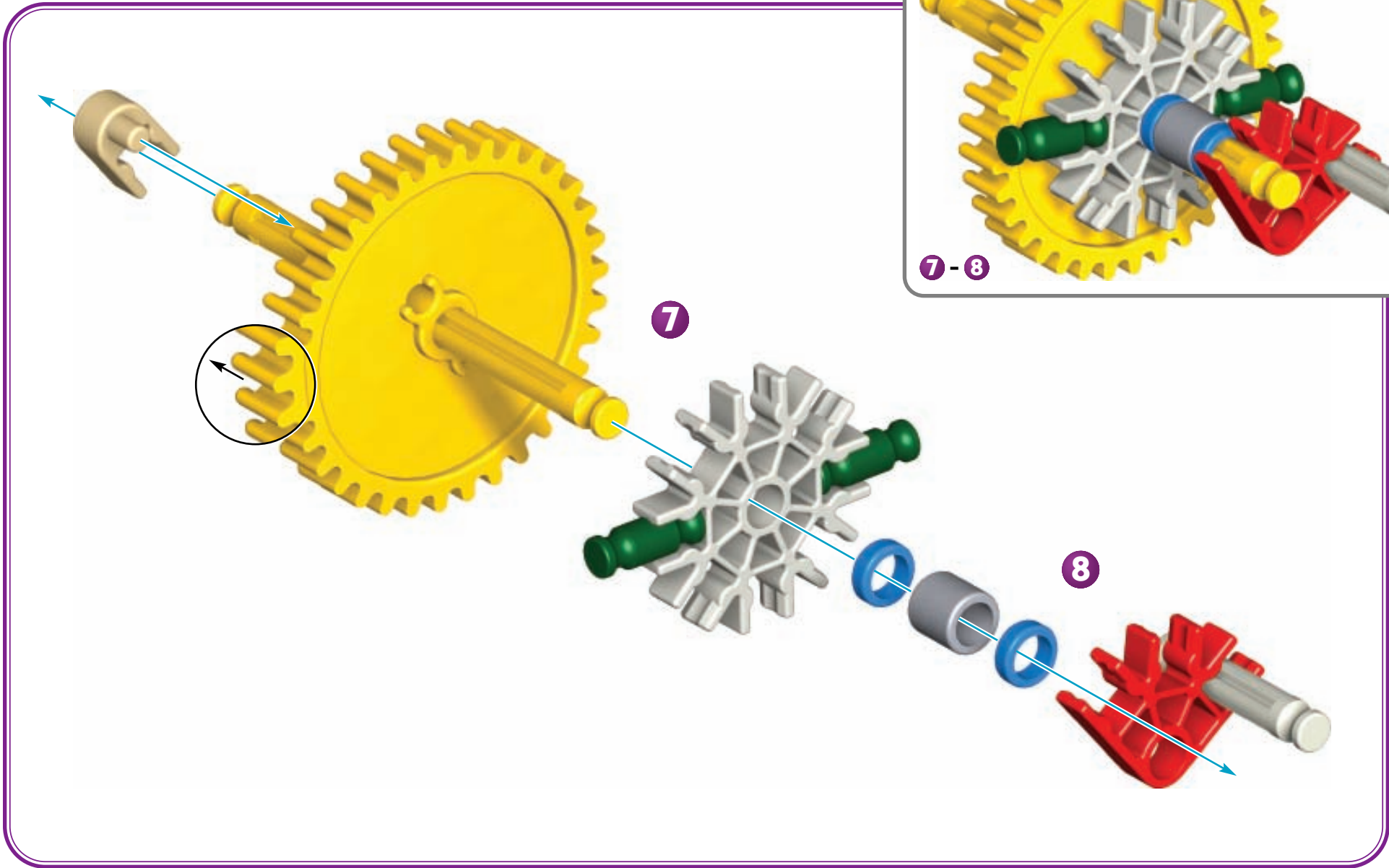

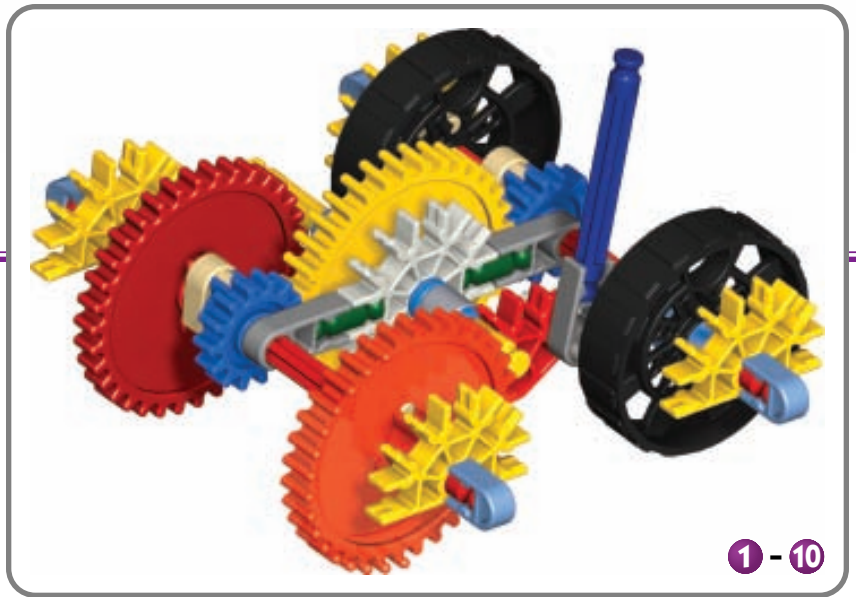
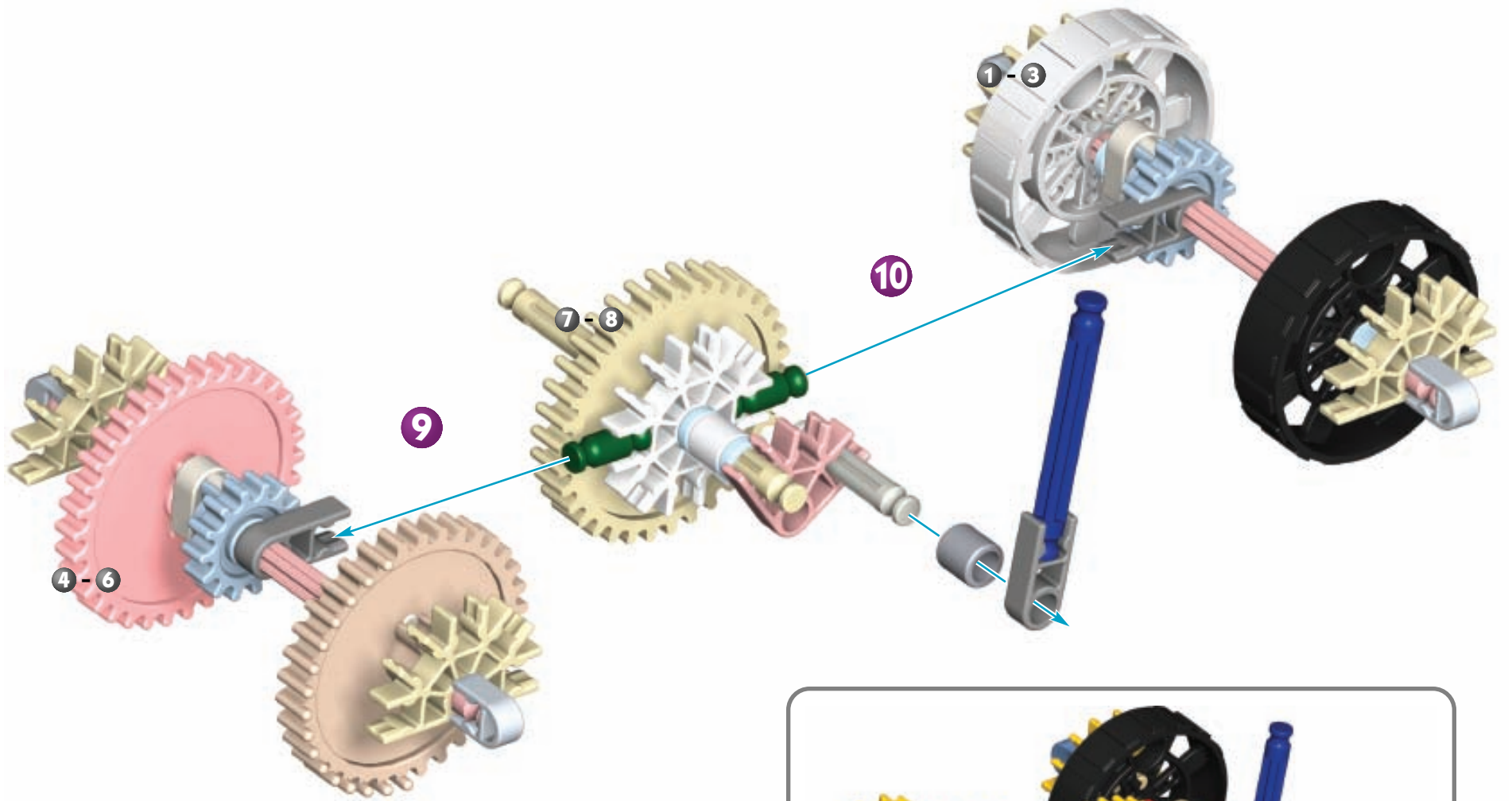

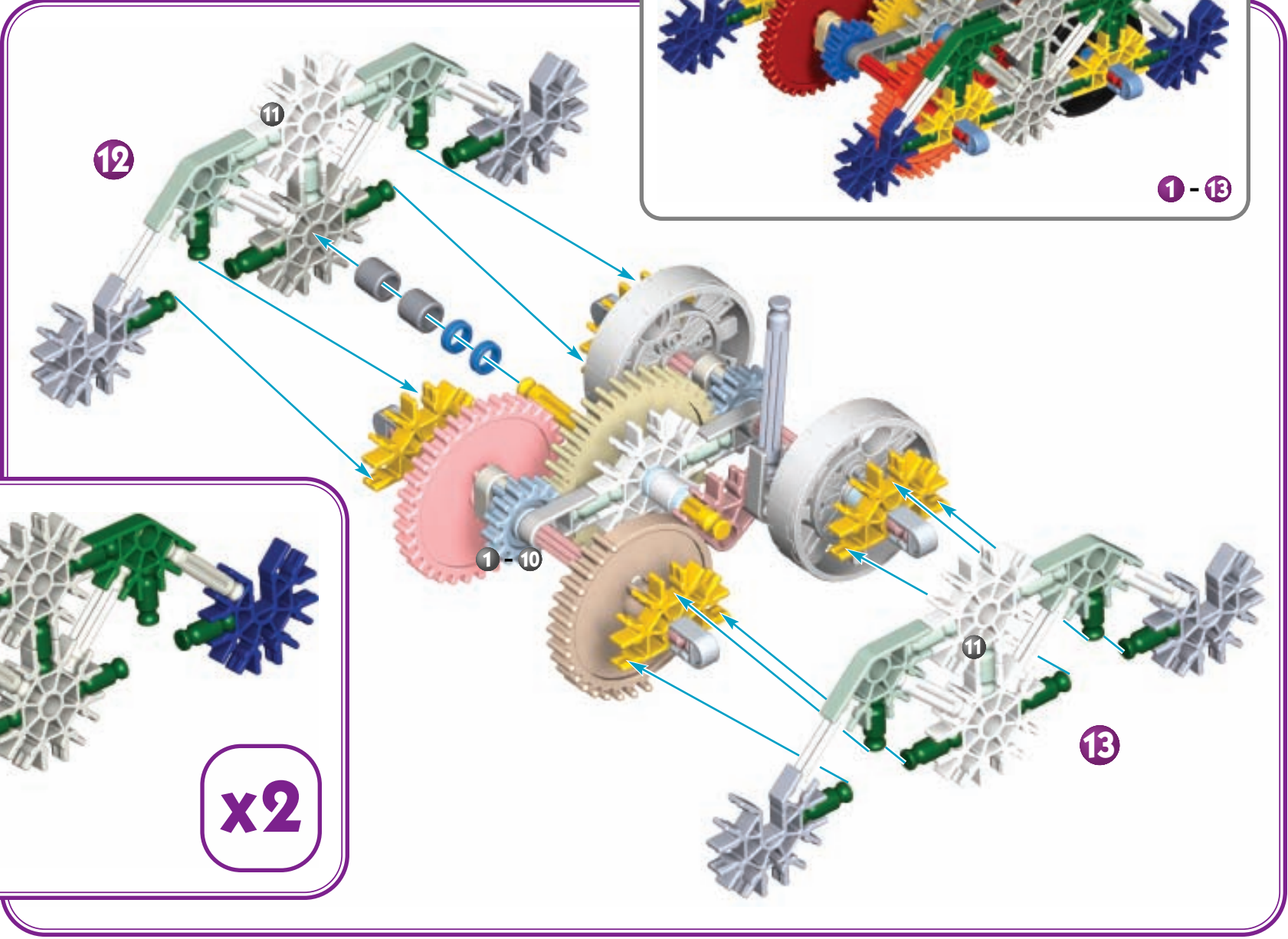
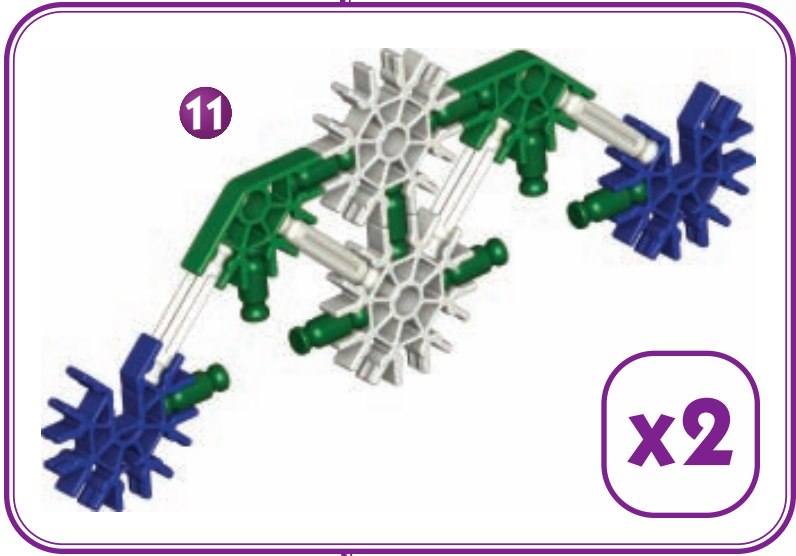

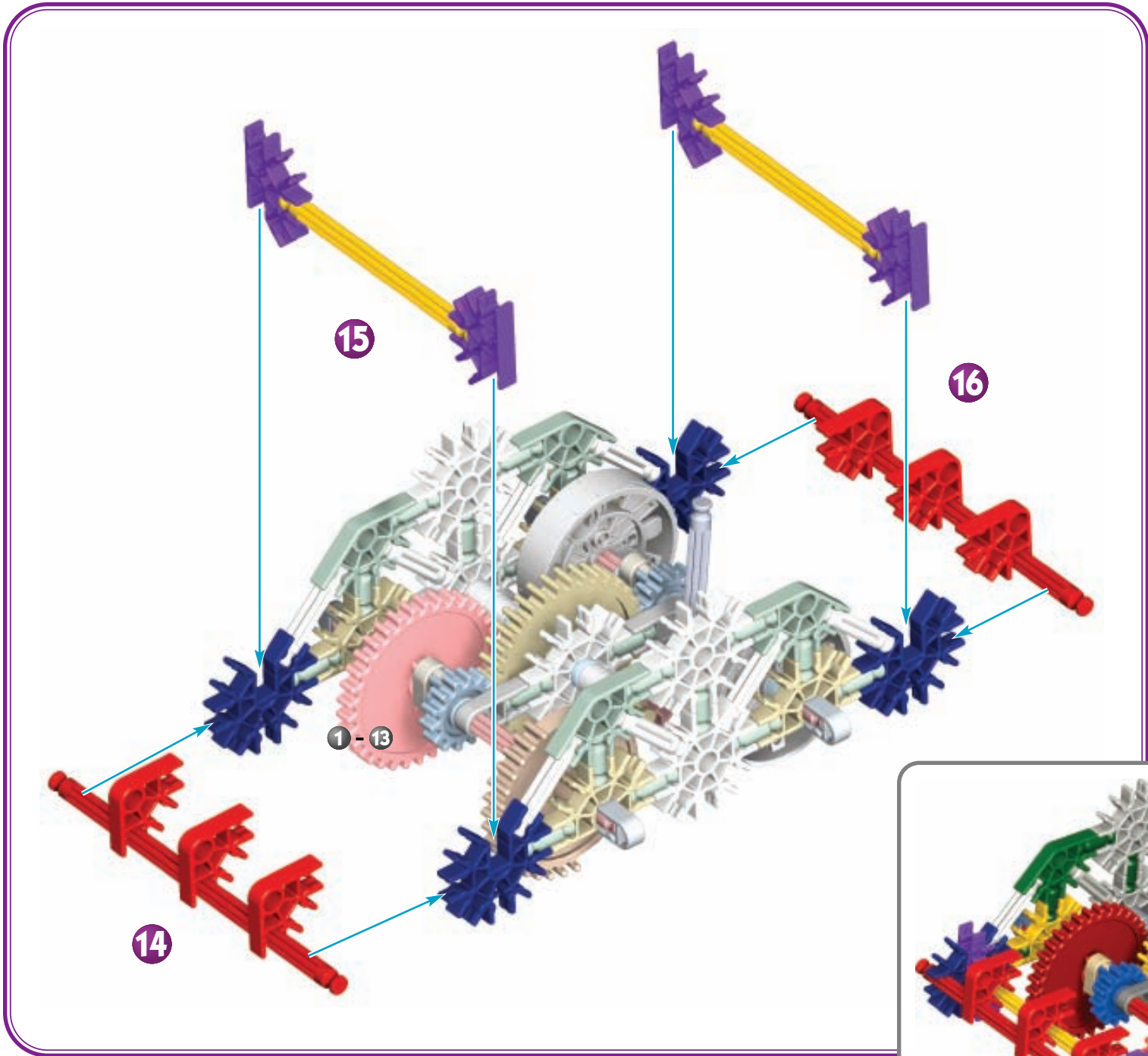

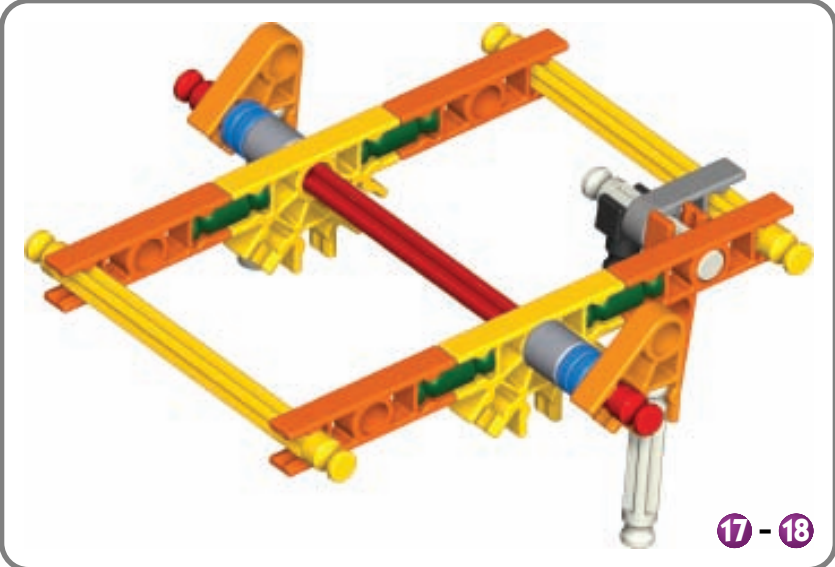
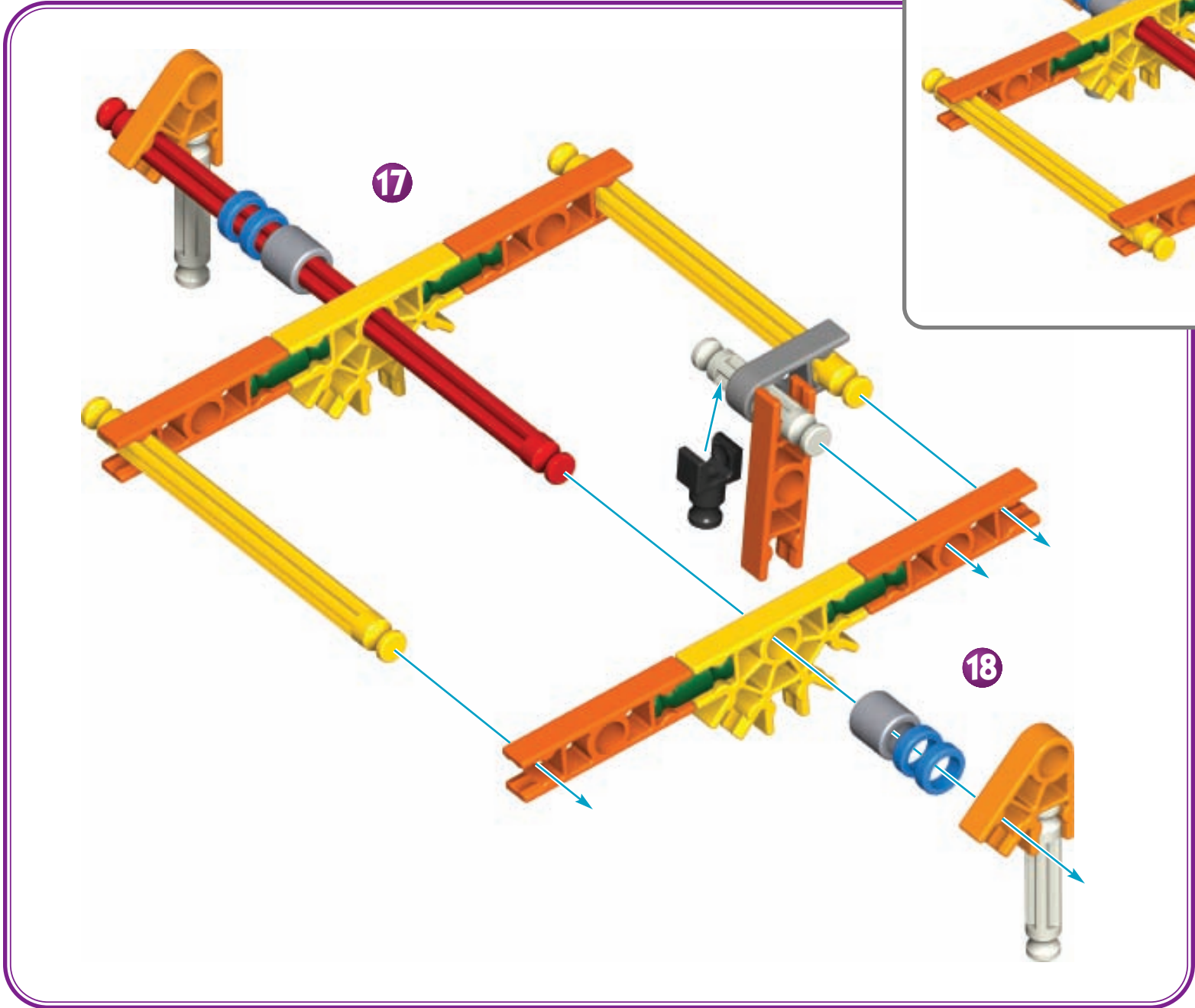



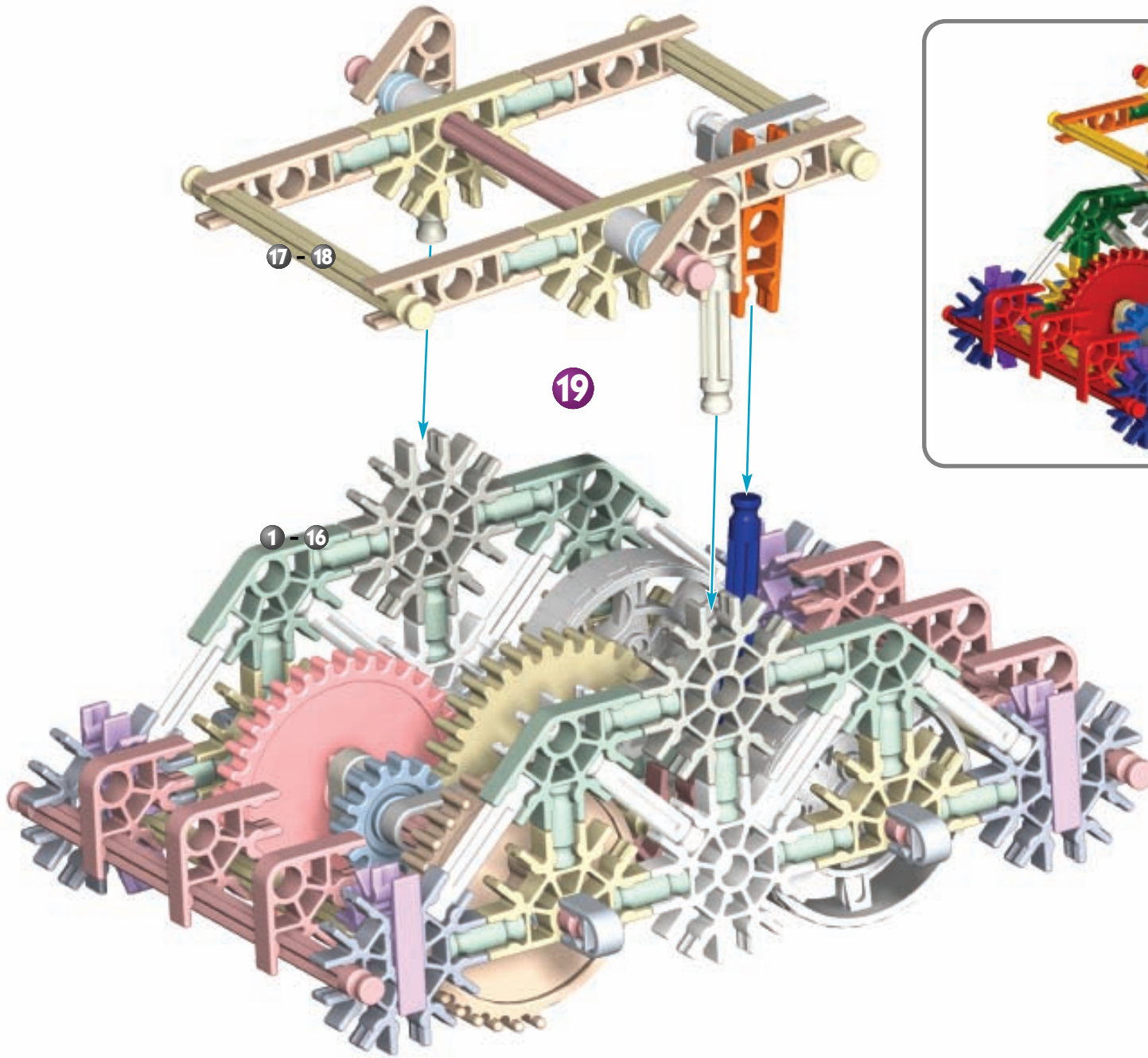

**K'NEX**  
**ROBOT**

**GEAR  
ACTION™**

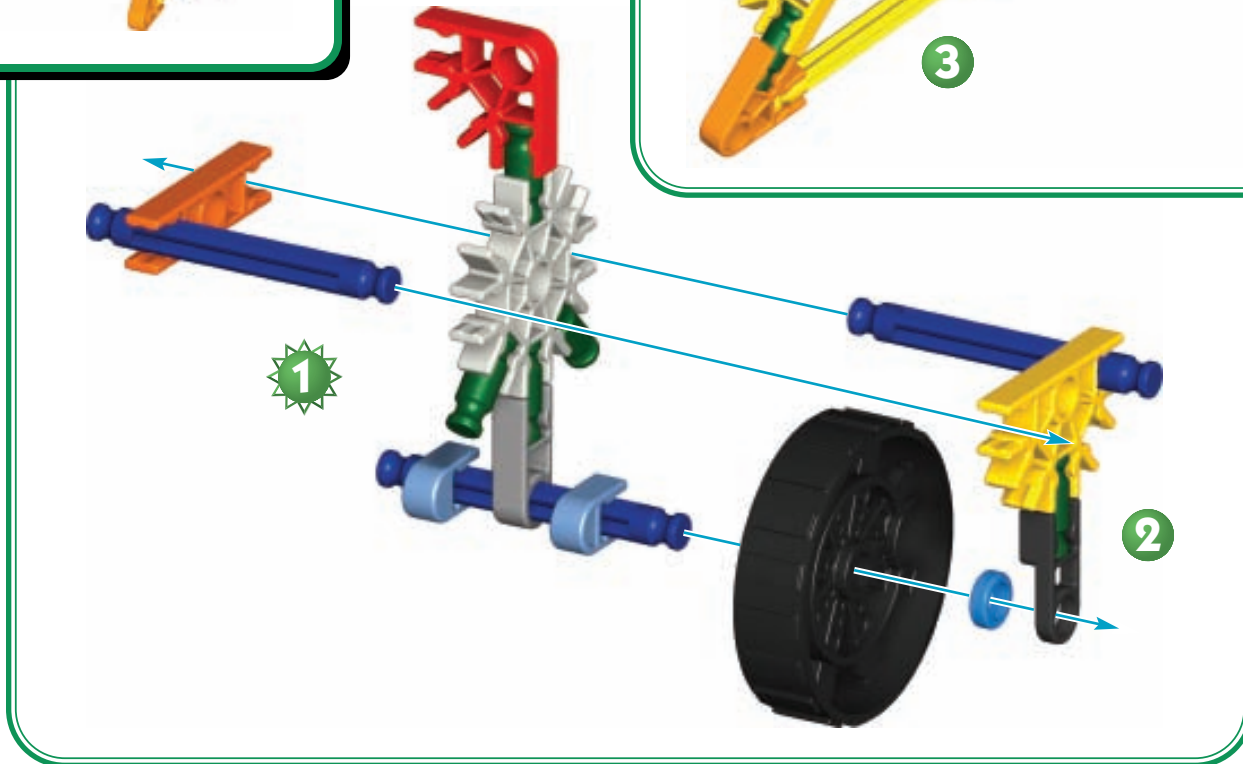
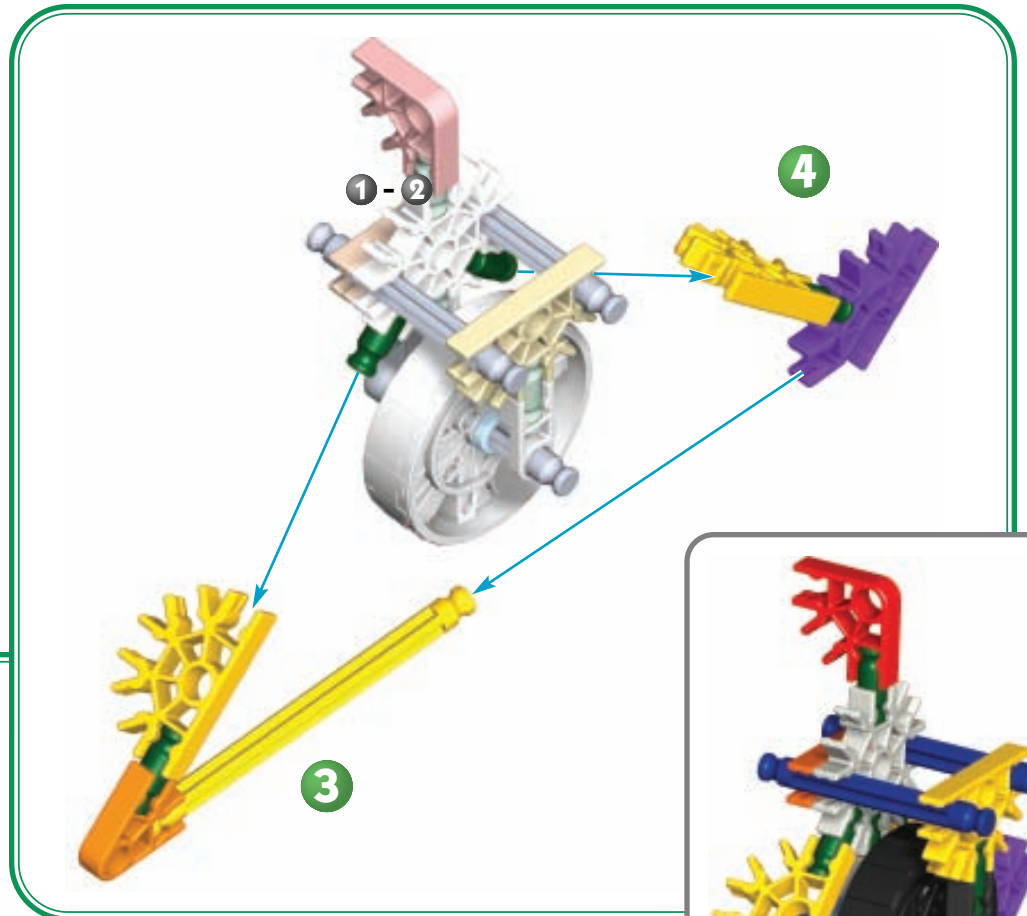

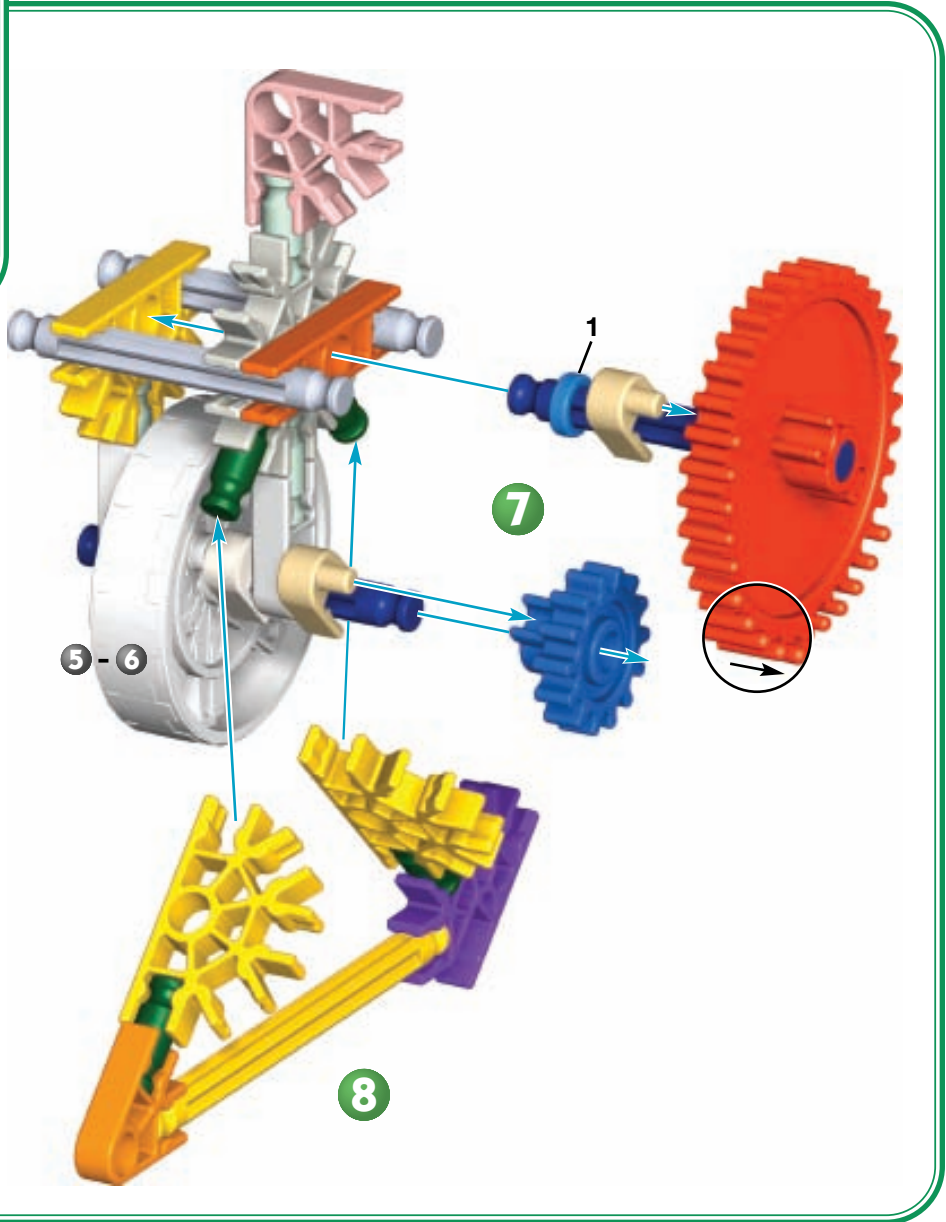
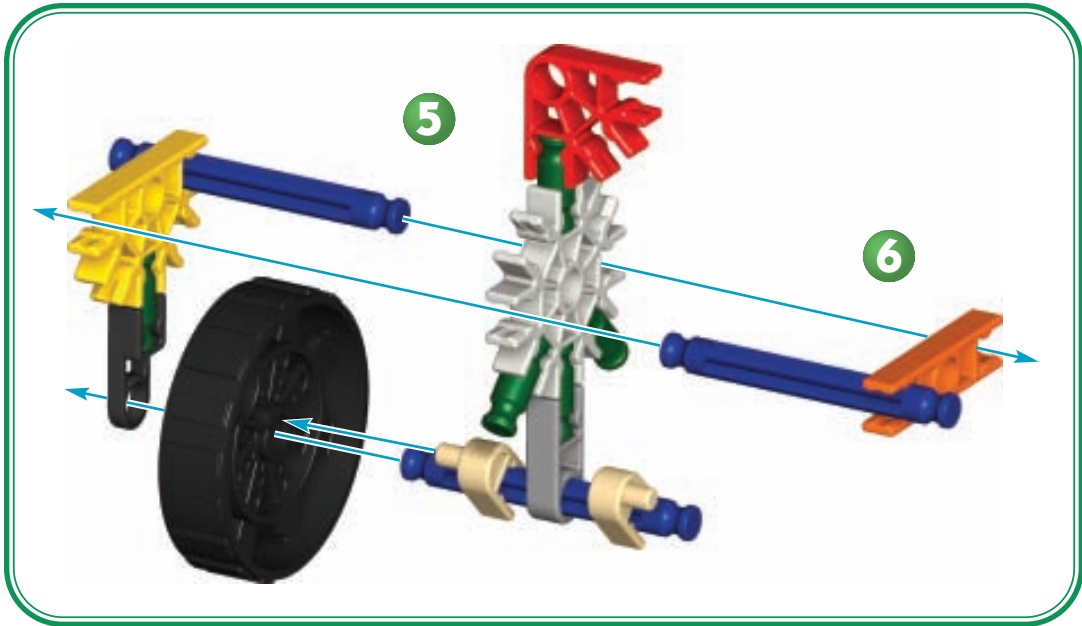

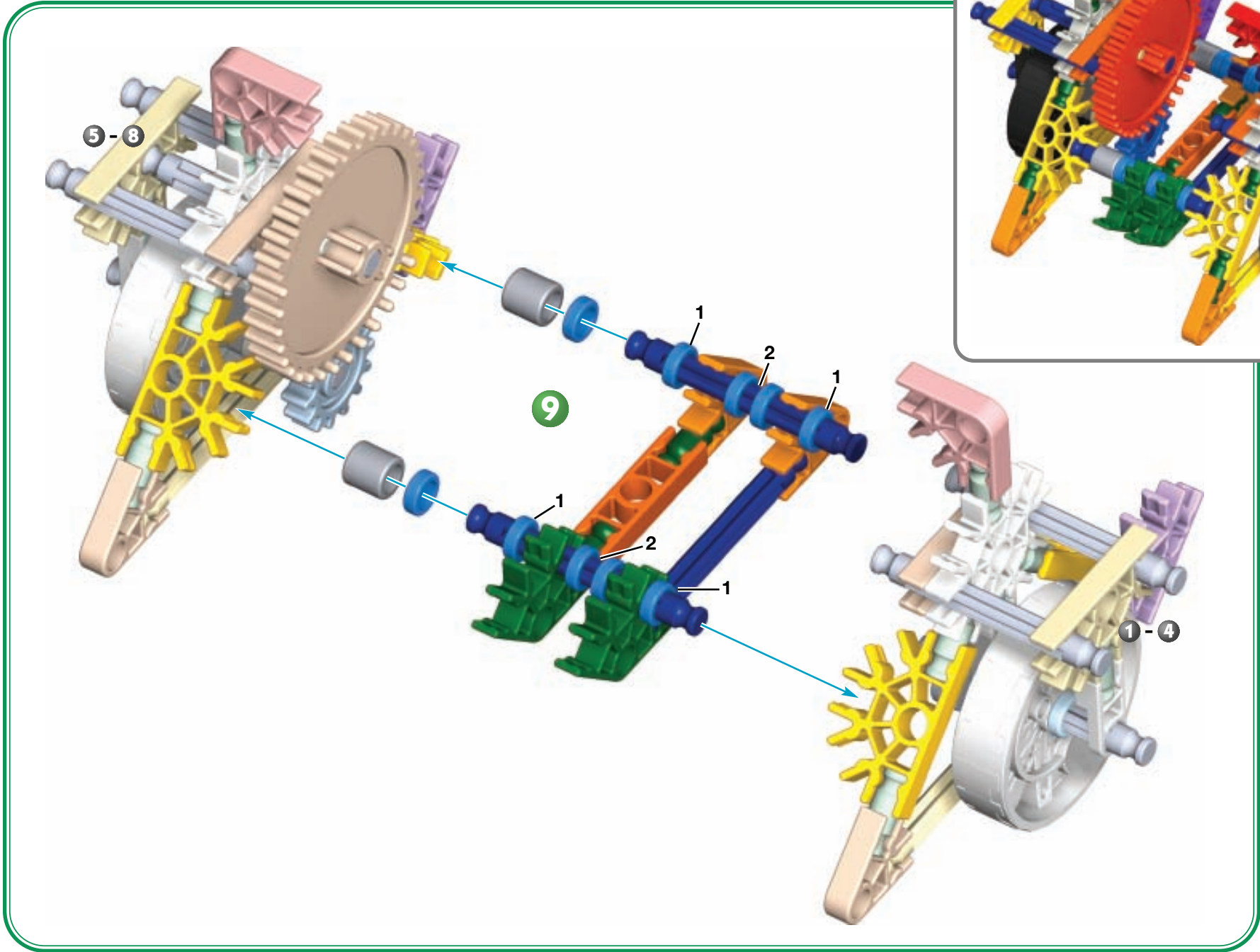

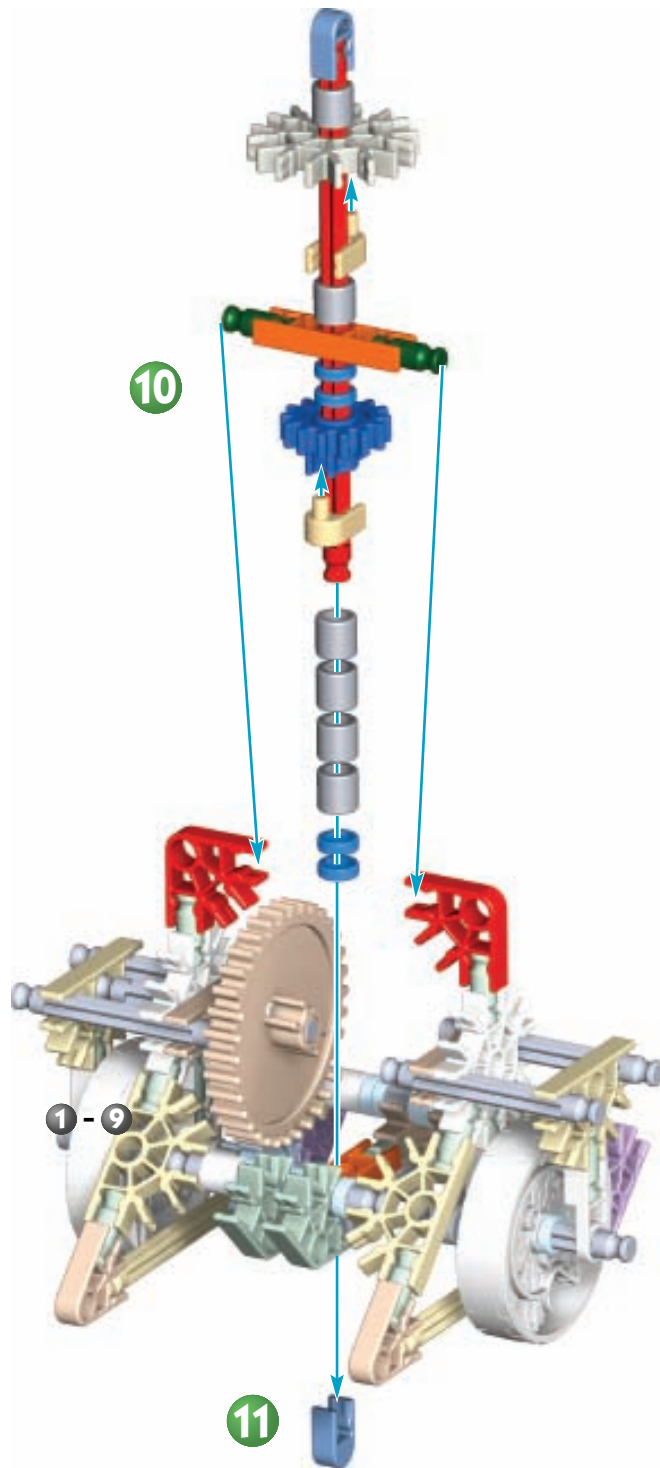

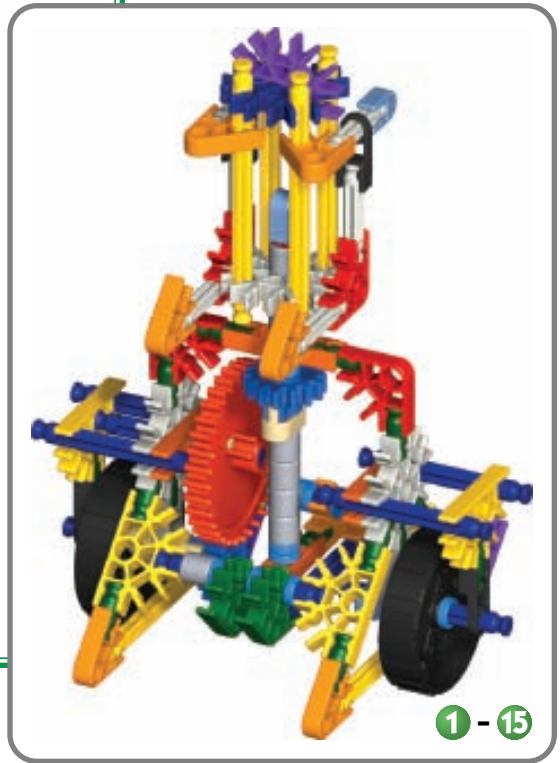
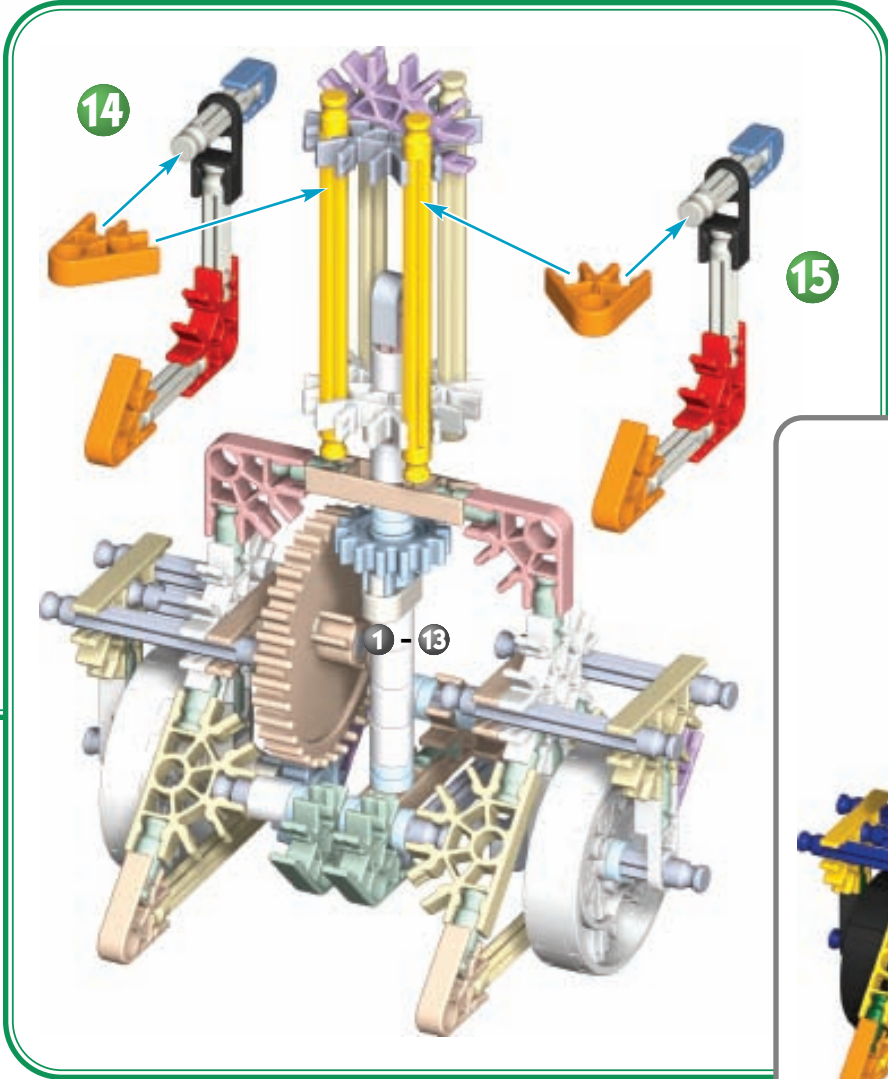
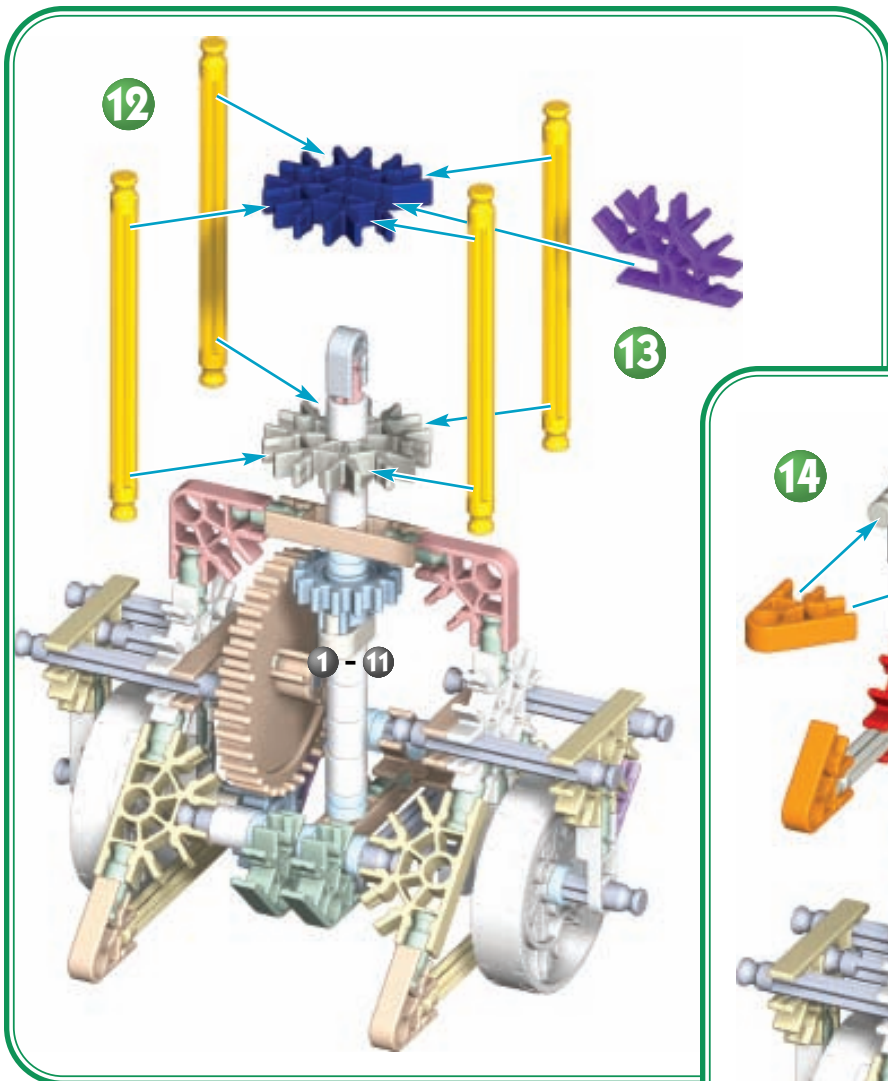

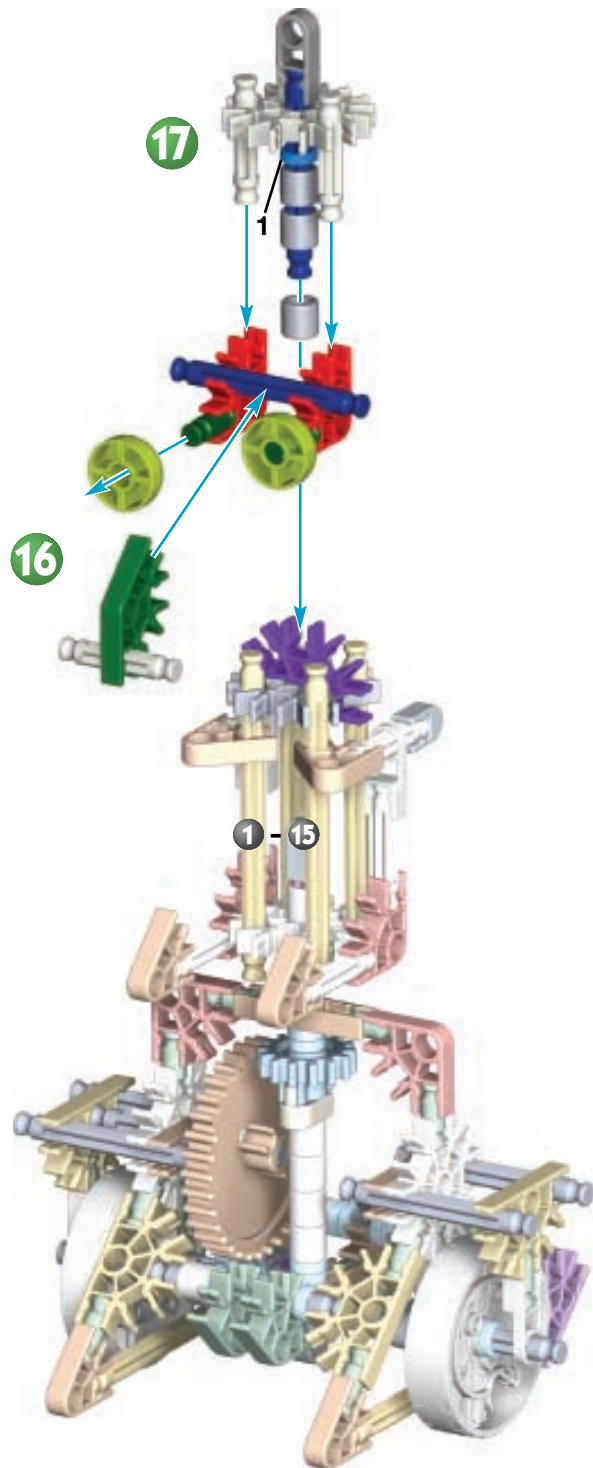

K'NEX

# ROLLERBLADE



GEAR ACTION™

x2



1 ROLLERBLADE



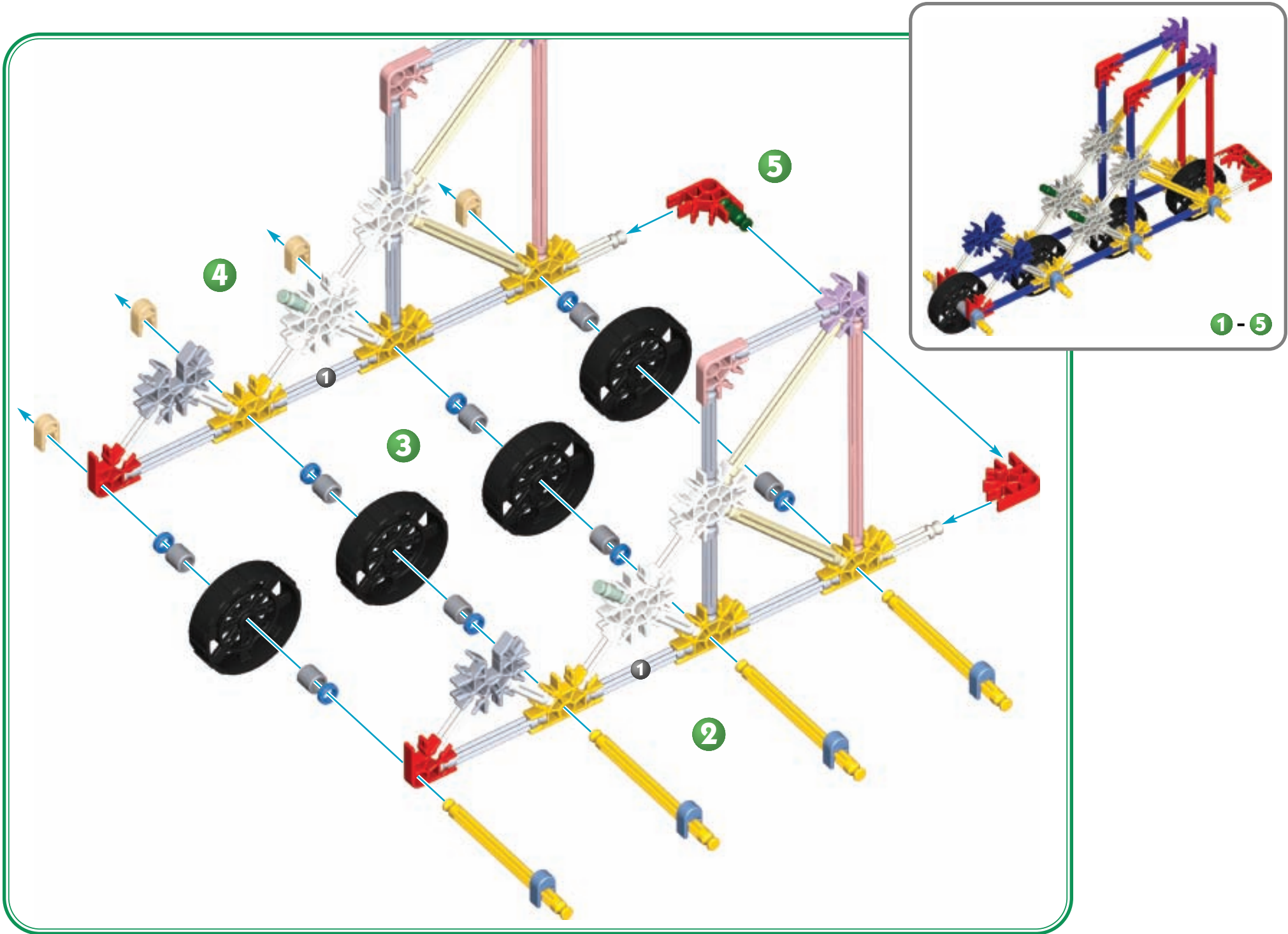

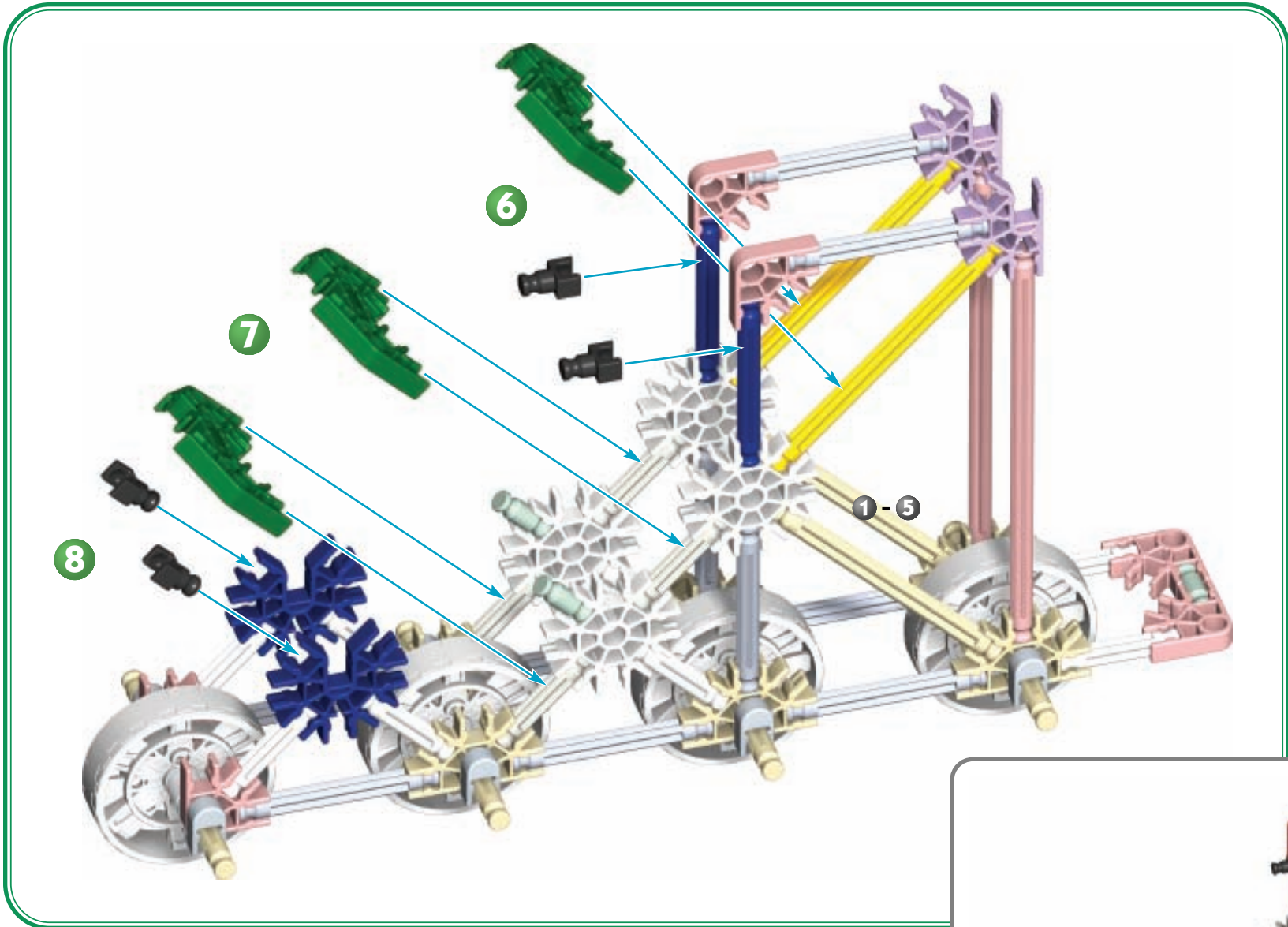

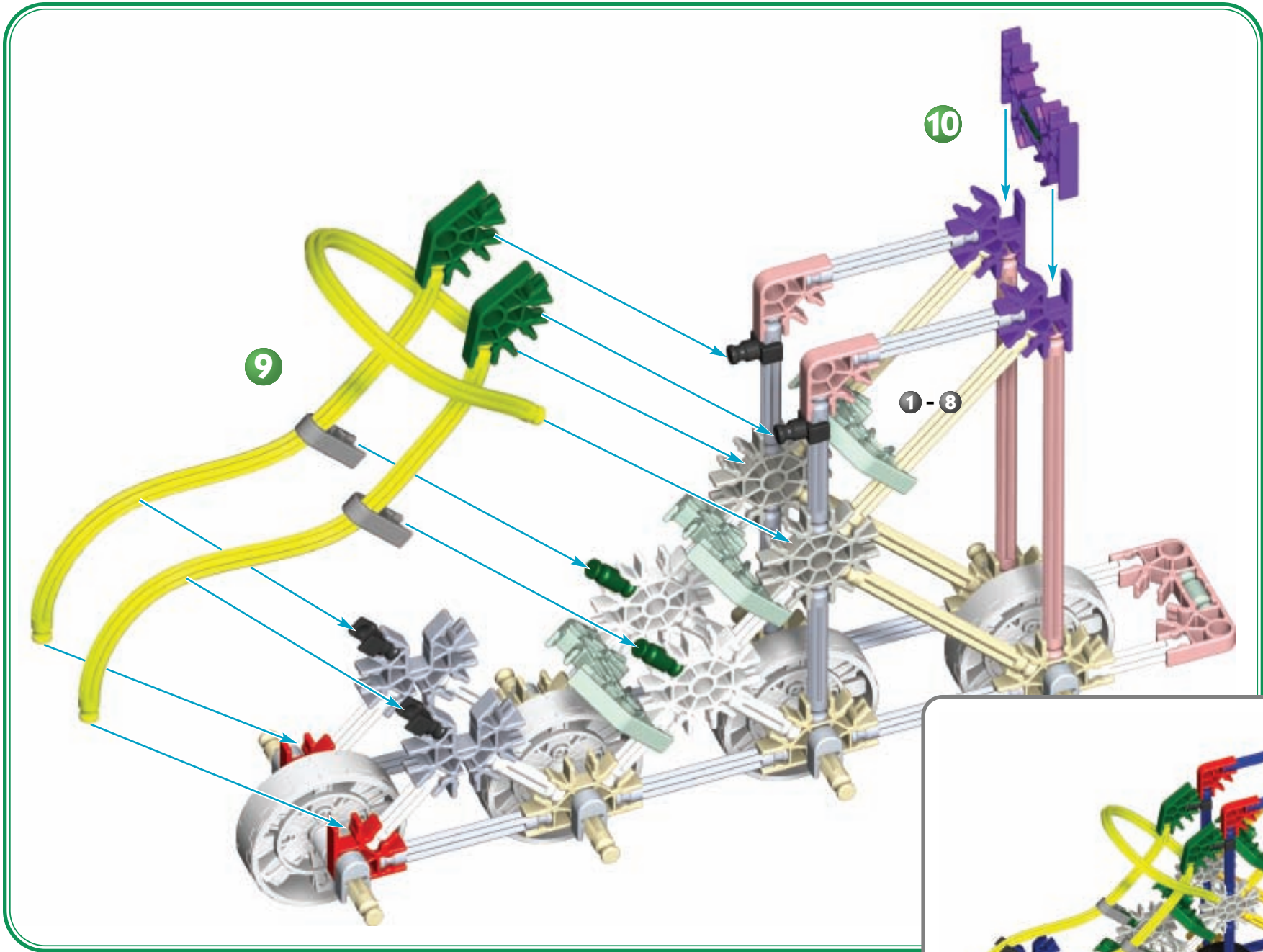

K'NEX  
SWING

GEAR  
ACTION™

