

# K'NEX®

Building Worlds Kids Love®

## 2-IN-1 FERRIS WHEEL BUILDING SET

2-EN-1  
LA GRANDE  
ROUE  
JEU DE  
CONSTRUCTION



3.0'  
0.93m

**2**  
**MOTORS**  
**MOTEURS\***

\* Moteurs

9+

14579



- Not included
- Non fournies
- Não se incluem
- Nicht enthalten
- Non incluse
- Não estão incluídas
- Niet inbegrepen

BUILD  
CONSTRUIRE

2

AT ONCE!  
À LA FOIS! \*\*

\*\* ;Construye 2 a la vez!  
Baut 2 auf einmal!  
Costruisci 2 alla volta!  
Constrói 2 de uma vez!  
Bouwt 2 tegelijk!



# CONTENTS

**K’NEX Building Basics** ..... 4

**Ferris Wheel** ..... 5

**Spin Ride**..... 18

**Tumbling Tornado** ..... 24

**Keep this important information for future reference**

## Important Stuff for Parents and Kids

**⚠ WARNING:** CHOKING HAZARD - Small parts. Not for children under 3 years.

**CAUTION:** Keep hands, face, hair and clothing away from all moving parts.

**CAUTION:** Be careful not to tip the model over. Model should be placed on a flat and hard surface.

- Share the K’NEX experience with your child and make building with K’NEX a family fun adventure.
- Take your time to enjoy the building process. Don’t rush!
- While you’re building make sure you face your model in the same direction as the pictures show in the instructions.
- Product and colors may vary.

# Battery Information

## How to Insert and Remove Batteries

Use a small Phillips head screwdriver to loosen the screw. Insert 2 fresh AA batteries\*\*\* (LR6) into the compartment with the correct polarity (+/-) as shown here.

Do not put rods smaller than 2 inches in any openings of the motor; they will damage the motor and cannot be removed. Install batteries before building models.

\*\*\* Not included

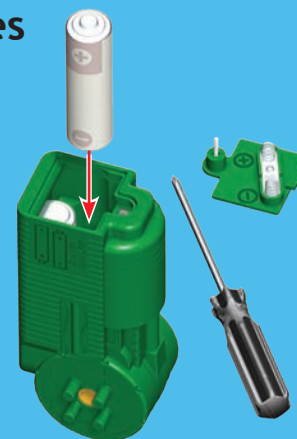

## CAUTION: To Avoid Battery Leakage

- Insert batteries with correct polarity (+/-) as shown.
- Do not mix different types of batteries.
- Do not mix alkaline, standard (carbon-zinc) or rechargeable (nickel-cadmium) batteries.
- Do not mix new and used batteries. Only batteries of the same or equivalent type recommended should be used.
- Remove exhausted batteries from the toy; do not short-circuit supply terminals.
- Remove all batteries if the toy will not be used for a long period of time.

### Important Tips

- Alkaline batteries are recommended.
- Rechargeable batteries are not recommended.
- Remove rechargeable batteries before recharging; they must be charged only under adult supervision.
- Non-rechargeable batteries must not be recharged.
- Keep components free of dust; do not immerse or use in water.
- Do not dispose of batteries in a fire; they could leak or explode and cause injury.



The wheeled bin indicates this product cannot be disposed of with household waste due to presence of hazardous substances. To protect human health and environment, check your local authority for recycling advice and facilities (2012/19/EU, Europe only).

**Go to [KNEX.COM](http://KNEX.COM) for instruction updates**

# CONTENUS

K'NEX Bases de Construction .....	4
Grande Roue .....	5
Tour de Tournoyer .....	18
Tornade en Tombant.....	24

**Gardez précieusement cette notice pour vous y référer ultérieurement**

## Informations Importantes pour les Parents et les Enfants

**⚠ AVERTISSEMENT : RISQUE D'ÉTOUFFEMENT** - Pièces de petite taille. Ne convient pas aux enfants de moins de 3 ans.

**ATTENTION :** Garde les cheveux, les doigts, la figure et les vêtements à l'écart de toutes les pièces mobiles.

**ATTENTION :** Faire attention de ne pas renverser le modèle. Le modèle devrait être placé sur une surface plate et dure.

- Ne pas bloquer les rails avec des objets ou la corps.
- Partage l'expérience K'NEX avec ton enfant et fais du montage K'NEX un agréable projet de famille.
- Prends ton temps lors du montage. Ne te presse pas.
- Essaie de situer ton modèle dans le même sens que les instructions durant le montage.
- Le produit et les couleurs peuvent varier.

**Allez [knext.com](http://knext.com) à pour les mises à jour d'instruction**

## Informations sur les Piles

### Comment mettre et retirer des piles

Utiliser un petit tournevis pour desserrer la vis et pour enlever le couvercle des piles. Insérer 2 piles AA (LR6)<sup>\*\*\*</sup> neuves dans le compartiment en respectant la polarité (+/-). N'insérez pas de tige trop courte dans le moteur, elle pourrait rester coincée et l'endommager.

Installe les piles avant de réaliser tes constructions.

<sup>\*\*\*</sup> Non fournies

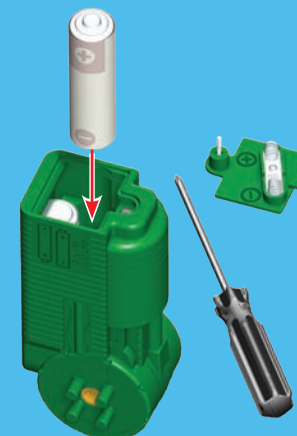

### ATTENTION : Pour éviter la fuite des piles

- Insérez les piles en respectant la polarité (+/-) comme indiqué.
- Ne pas mélanger différents types de piles.
- Ne pas mélanger des piles alcalines avec des piles standard (carbone-zinc), ou des piles rechargeables (au nickel-cadmium).
- Ne pas mélanger des piles neuves avec des piles usées. Il convient d'utiliser uniquement des piles du type recommandé ou d'un type équivalent.
- Retirer toujours les piles faibles ou mortes du produit ; ne pas faire court-circuiter les terminaux.
- Ne pas jeter les piles dans le feu ; elles risqueraient de fuir ou d'exploser et d'entraîner des blessures.

### Conseils Importants

- Les piles alcalines sont recommandées.
- Les piles rechargeables ne sont pas recommandées.
- Retirer les piles rechargeables du jouet avant de les recharger; elles doivent être chargées exclusivement en présence d'un adulte.
- Les piles qui ne sont pas rechargeables ne doivent pas être rechargées.
- Veiller à ce que les éléments restent à l'abri de la poussière ; ne pas les plonger ni les utiliser dans l'eau.
- Ne pas jeter les piles dans le feu ; elles risqueraient de fuir ou d'exploser et d'entraîner des blessures.



Le symbole "poubelle à roulettes" indique que ce produit ne peut pas être éliminé avec vos déchets ménagers en raison de la présence de substances dangereuses.

Afin de protéger votre santé et l'environnement, renseignez-vous auprès de vos autorités locales afin d'obtenir des conseils sur le recyclage et la localisation des installations adaptées (2012/19/EU, Europe uniquement).

## BUILDING BASICS

### Start Building

To begin your model, find the **1** and follow the numbers. Each piece has its own shape and color. Just look at the pictures, find the pieces in your set that match and then connect them together. Try to face your model in the same direction as the instructions while you build. The arrows show you where the parts connect, but not all connections points have arrows. Faded colors show you this section is already built.

## BASES DE LA CONSTRUCTION

### Démarre ta Construction

Pour commencer ton modèle, trouve l'étape numéro **1** et suis les numéros. Chaque pièce a sa propre forme et sa propre couleur. Regarde les illustrations, trouve les pièces qui correspondent à ce que tu vois et assemble-les. Pour t'aider pendant que tu construis, oriente ton modèle dans le même sens que les instructions. Les flèches t'indiquent où les pièces s'assemblent, mais les points de raccordement n'ont pas tous des flèches. Les pièces de couleur délavée sont celles que tu as déjà assemblées.

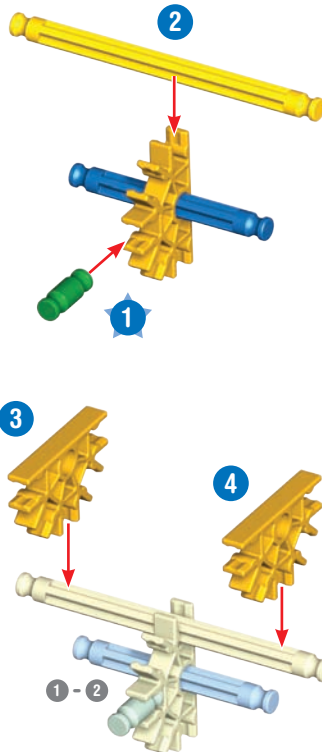

## PARTS LIST • Ferris Wheel

Before you start building, be sure to compare the parts in your set with the parts list here. If anything is missing, call or write to us using the information on the back cover. We are here to help you!

## LISTE DES PIÈCES • Grande Roue

Avant de commencer à construire, assure-toi de comparer les pièces dans ta boîte à la liste de pièces fournie ici. S'il manque quelque chose, téléphone-nous ou écris-nous en te servant des informations figurant au verso de la notice. Nous sommes là pour t'aider !

CHINA MADE  
PART  
FAIT AUX  
CHINE



AMERICAN MADE PARTS  
FAIT AUX ETATS-UNIS

## Connectors

You can slide these special connectors together. Push tightly until you hear a "click". Pay close attention to the instructions and position them horizontally or vertically exactly as they are shown.

## Connecteurs

Tu peux assembler ces connecteurs spéciaux en les faisant glisser l'un dans l'autre. Pousse fort jusqu'à entendre un « clic ». Lis attentivement les instructions et positionne-les horizontalement ou verticalement, en suivant exactement les illustrations.

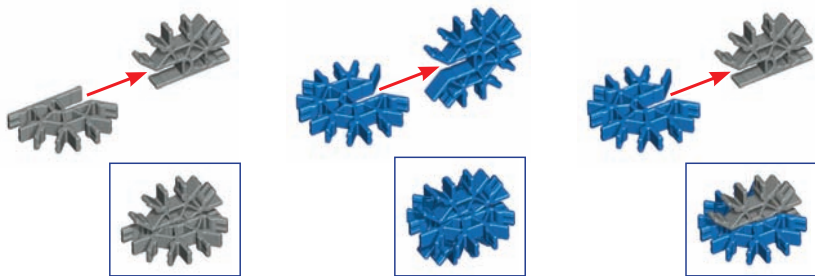

## Spacers

There are places in your model where you need to add blue and silver spacers. Be sure to use the correct number of spacers shown in the instructions.

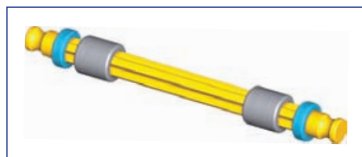

## Séparateurs

Il y a des endroits sur le modèle où des séparateurs sont nécessaires. Assure-toi d'utiliser la bonne couleur et le nombre de séparateurs, comme indiqué sur les instructions.

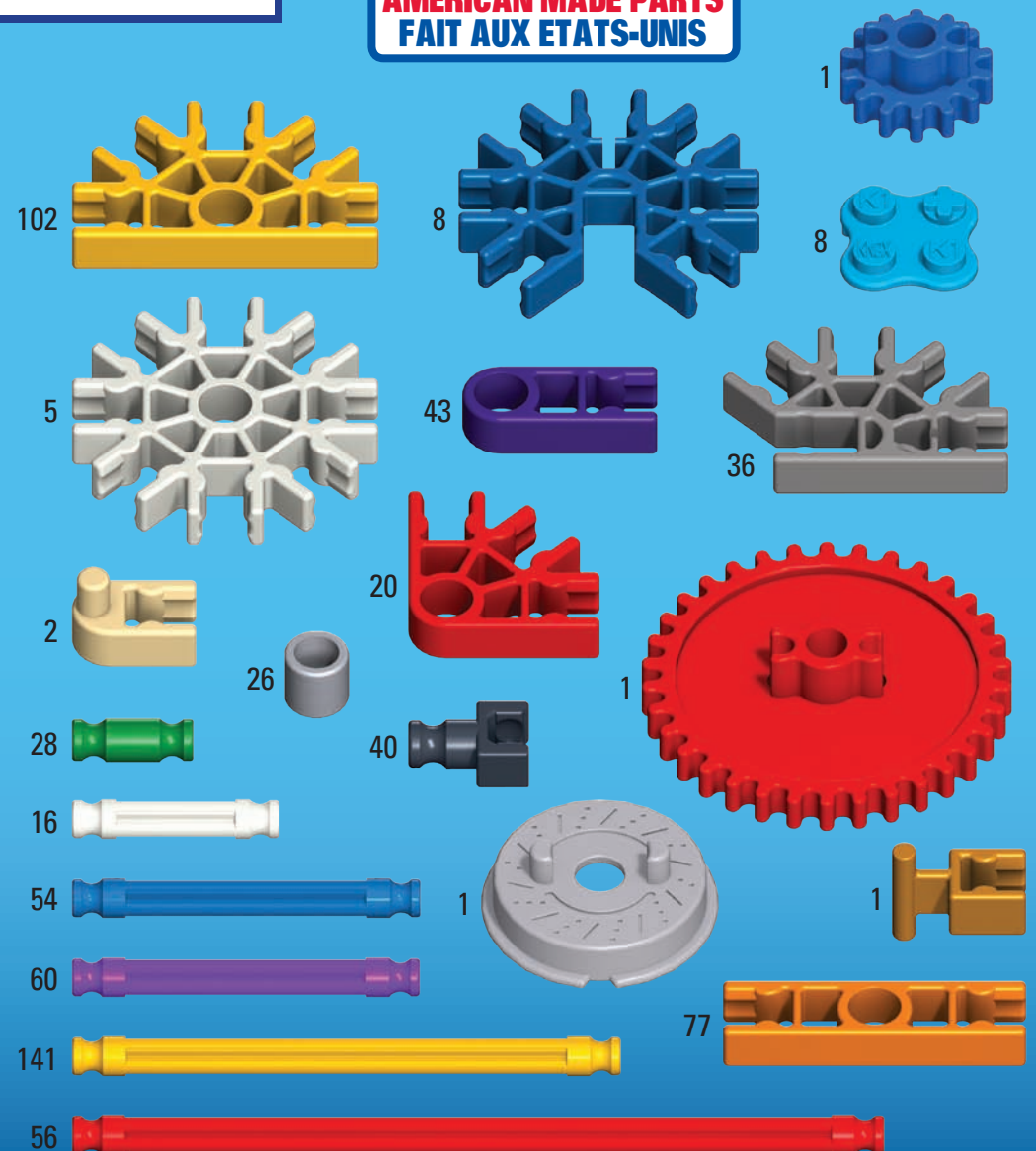

# FERRIS WHEEL GRANDE ROUE

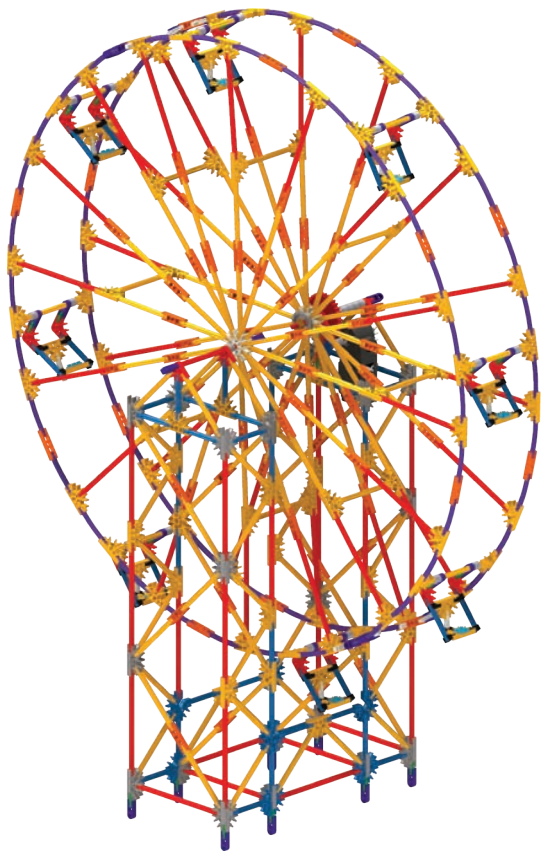

**WARNING: CHOKING HAZARD** – Small parts.  
Not for children under 3 years.

**ATTENTION : RISQUE D'ÉTOUFFEMENT** – Pièces de petite taille.  
Ne convient pas aux enfants de moins de 3 ans.

**ADVERTENCIA: PELIGRO DE ASFIXIA** – Piezas pequeñas.  
No para niños menores de 3 años.

**ACHTUNG: ERSTICKUNGSGEFAHR** – Kleinteile.  
Nicht geeignet für Kinder unter 3 Jahren.

**AVVISO: PERICOLO DI SOFFOCARE** – Pezzi piccoli parti.  
Non adatto per bambini sotto di 3 anni.

**AVISO: PERIGO DE SUFOCAÇÃO** – Peças pequenas.  
Não se destina a crianças com menos de 3 anos de idade.

**WAARSCHUWING: VERSTIKKINGSGEVAAR** – Kleine onderdelen.  
Niet geschikt voor kinderen jonger dan 3 jaar.

**CAUTION:** Keep hands, face, hair and clothing away from all moving parts.

**ATTENTION :** Garde les cheveux, les doigts, le visage et les vêtements à l'écart de toutes les pièces mobiles.

**PRECAUCIÓN:** Mantén el cabello, los dedos, la cara y la ropa alejada de las piezas móviles.

**VORSICHT:** Haare, Finger, Gesicht und Kleidungsstücke nicht mit beweglichen Teilen in Berührung kommen lassen.

**ATTENZIONE:** Tenere i capelli, le dita, il viso e i vestiti lontano da tutte le parti in movimento.

**CAUIDADO:** Mantém o cabelo, os dedos, a cara e a roupa afastados de todas as peças móveis.

**OPGEPAST:** Hou het haar, de vingers, het gezicht en kledij verwijderd van alle bewegende onderdelen.

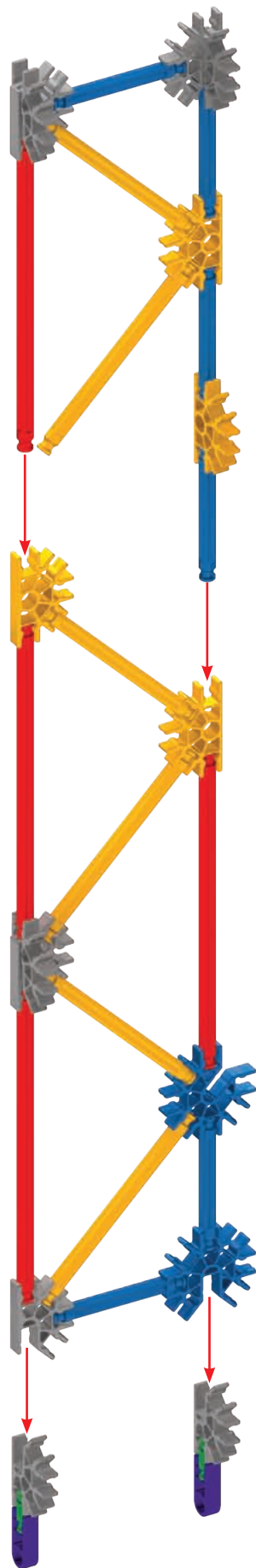

1

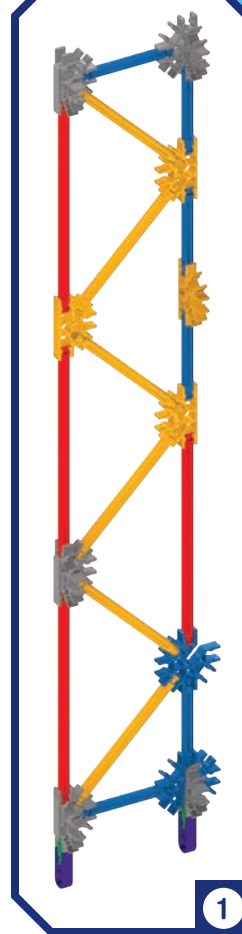

1

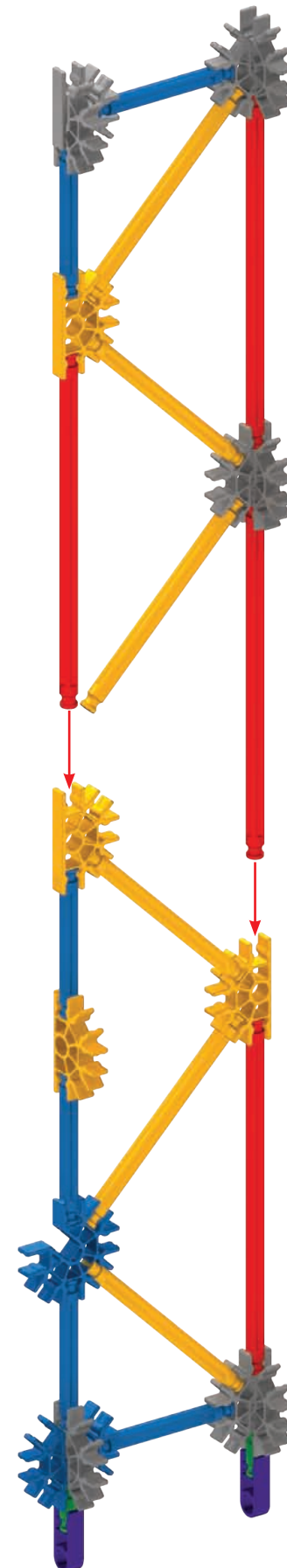

2

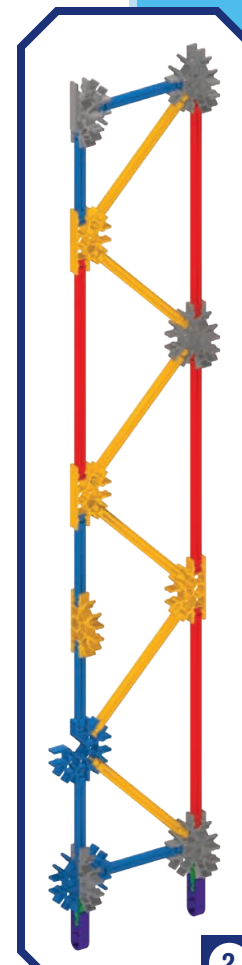

2

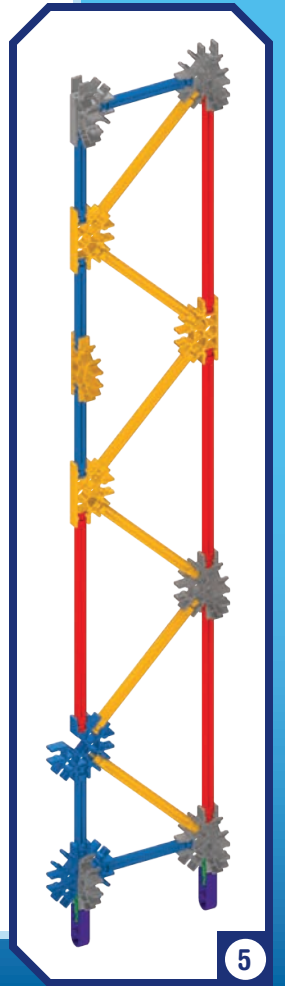
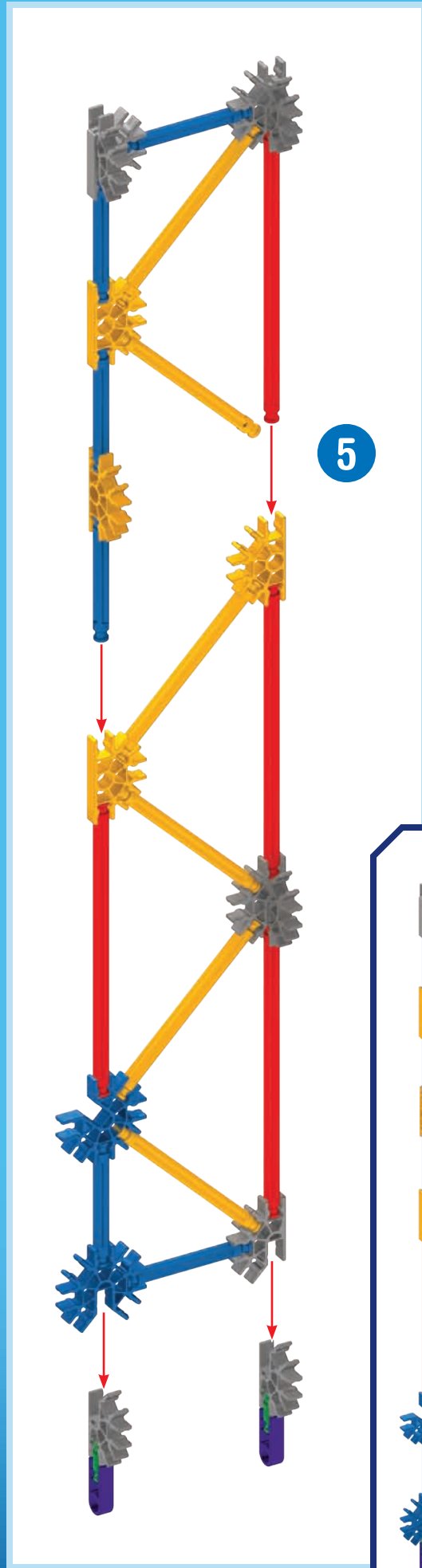
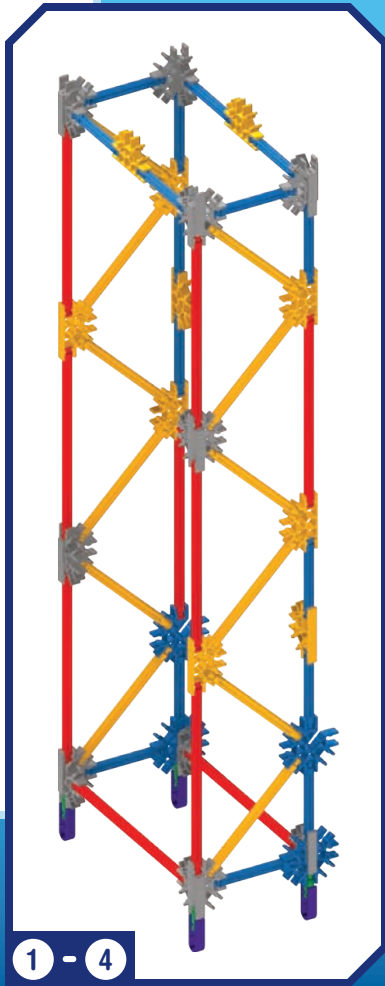
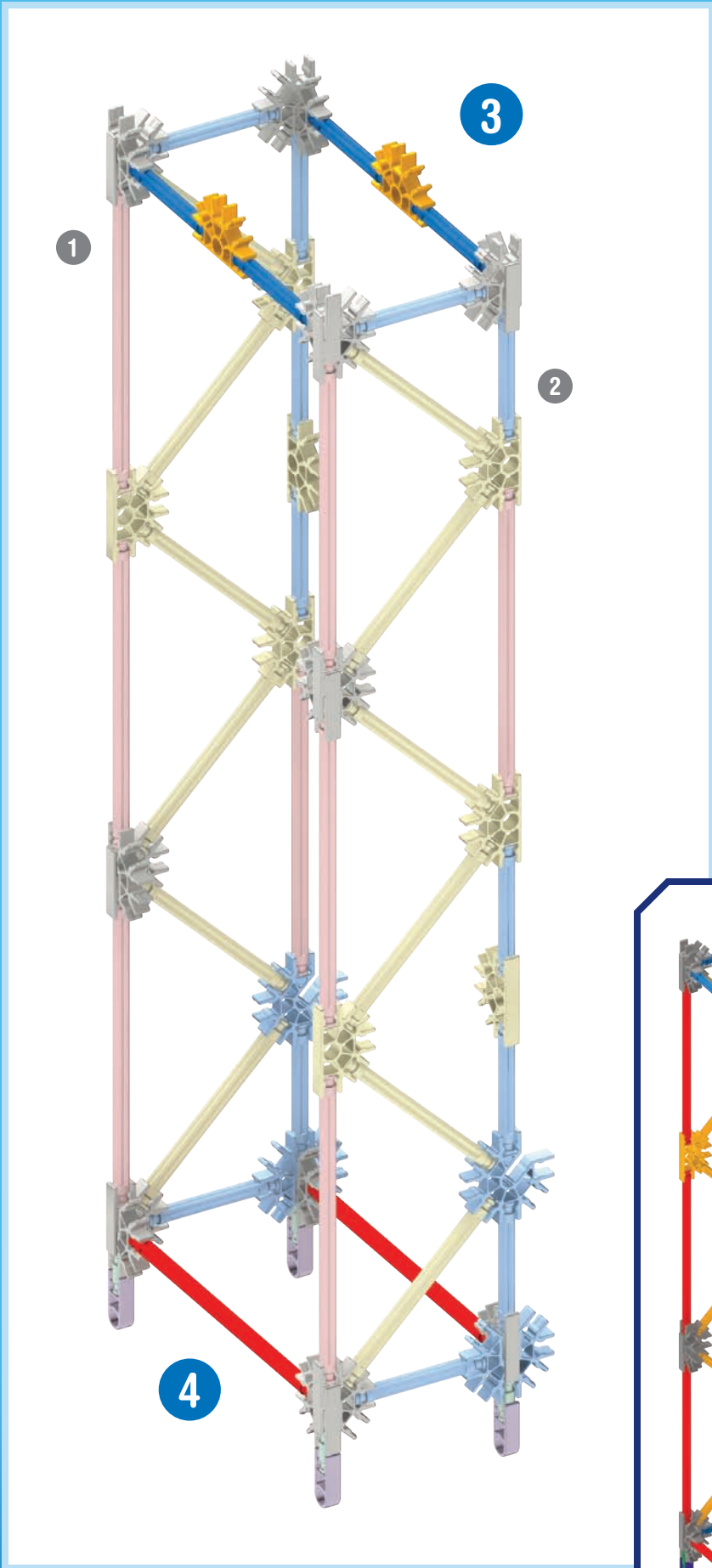

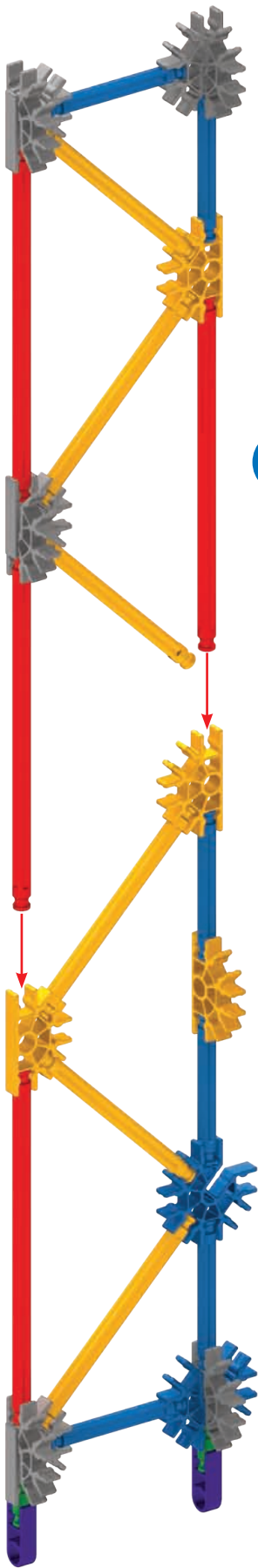

6

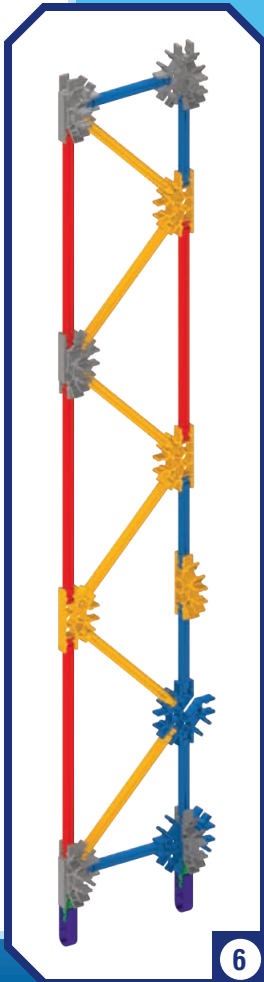

6

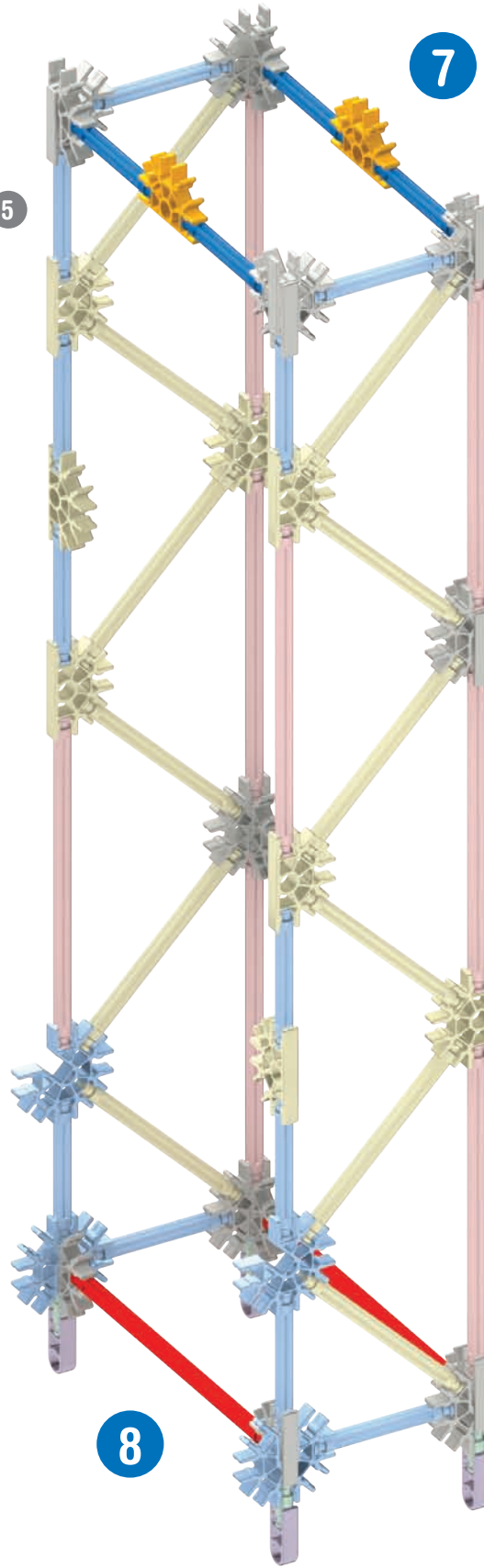

5

7

6

8

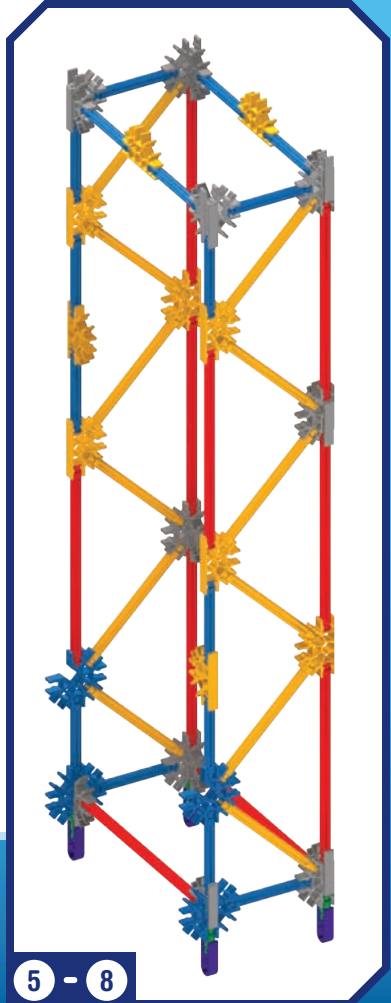

5 - 8

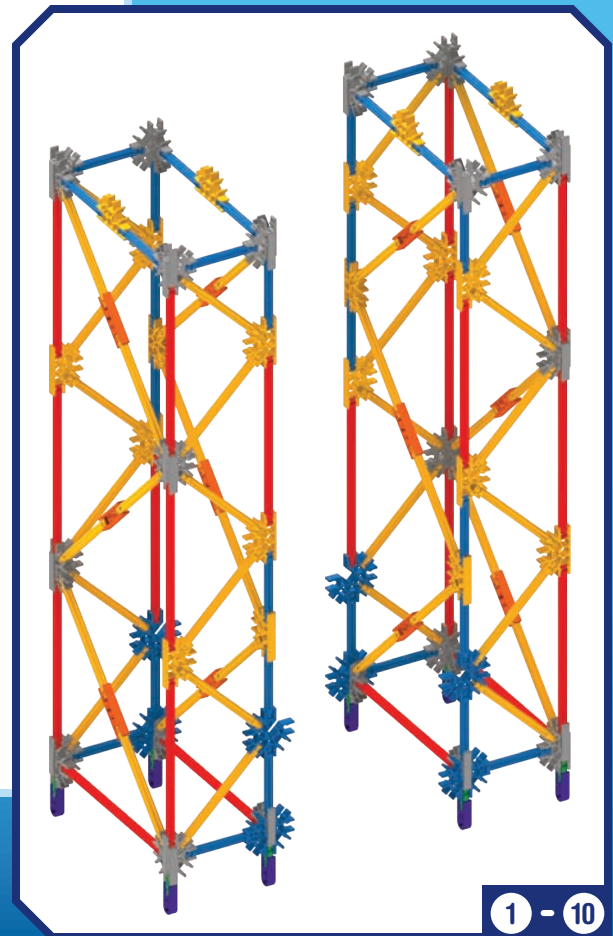
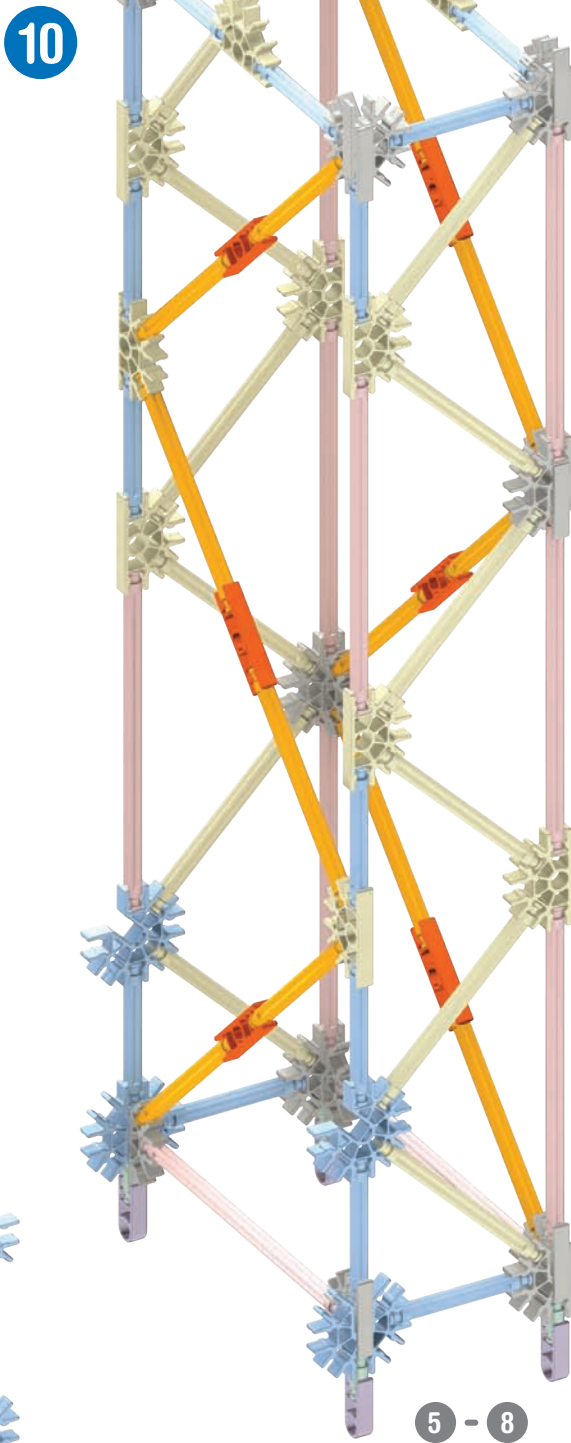
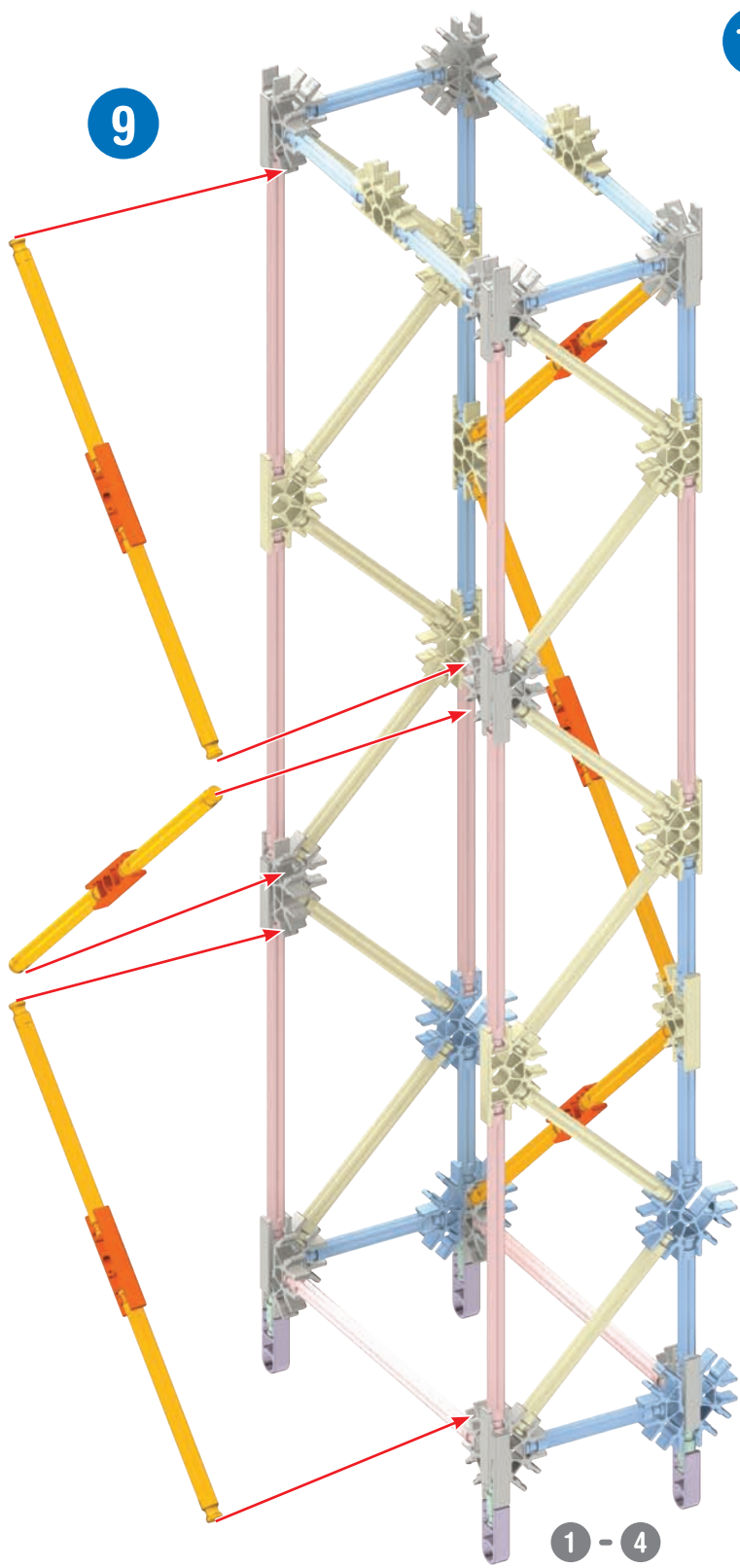

(EN) Did you install 2 AA (or LR6) batteries in the motor?  
 (FR) Avez-vous installé 2 piles AA (ou LR6) ?  
 (ES) ¿Instalaste 2 pilas AA (o LR6) en el motor?  
 (DE) Hast du 2 AA (oder LR6) Batterien in den Motor eingelegt?  
 (IT) Hai installato 2 batterie AA (o LR6) nel motore?  
 (PT) Foram instaladas as pilhas 2 AA (ou LR6) no motor?  
 (NL) Heb je 2 AA (of LR6)-batterijen in de motor geplaatst?

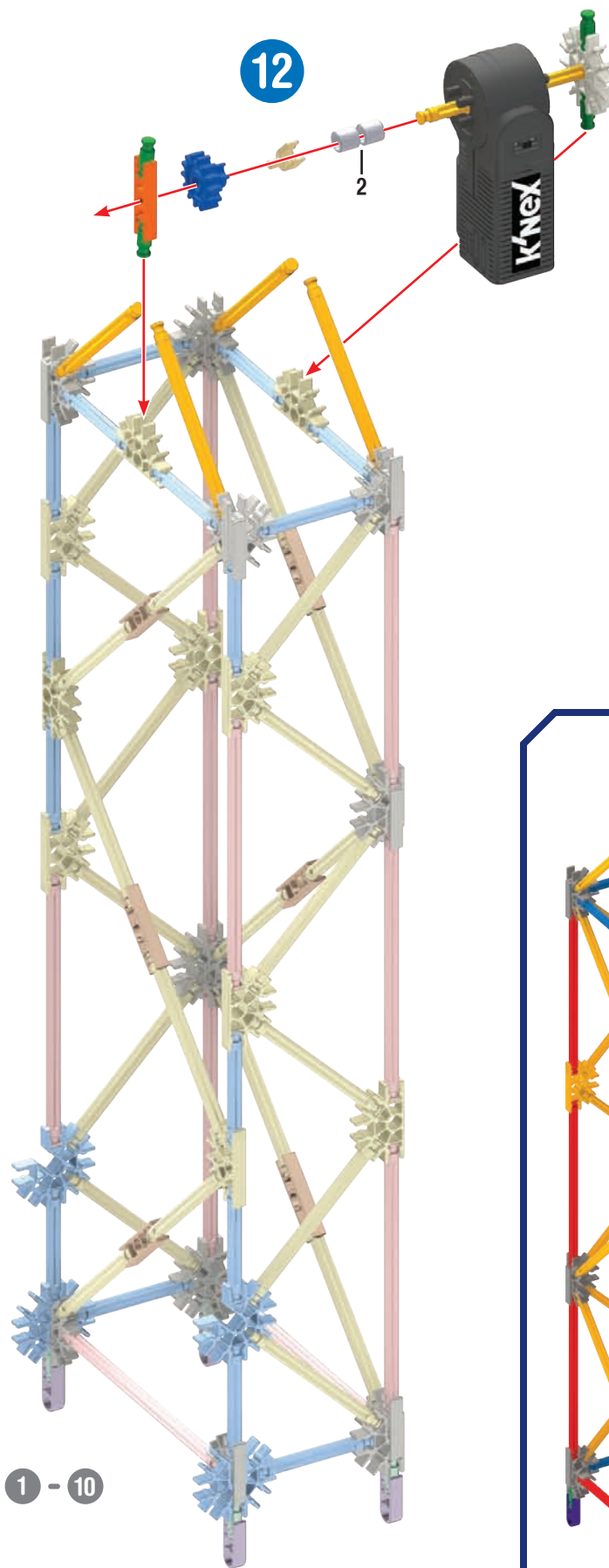
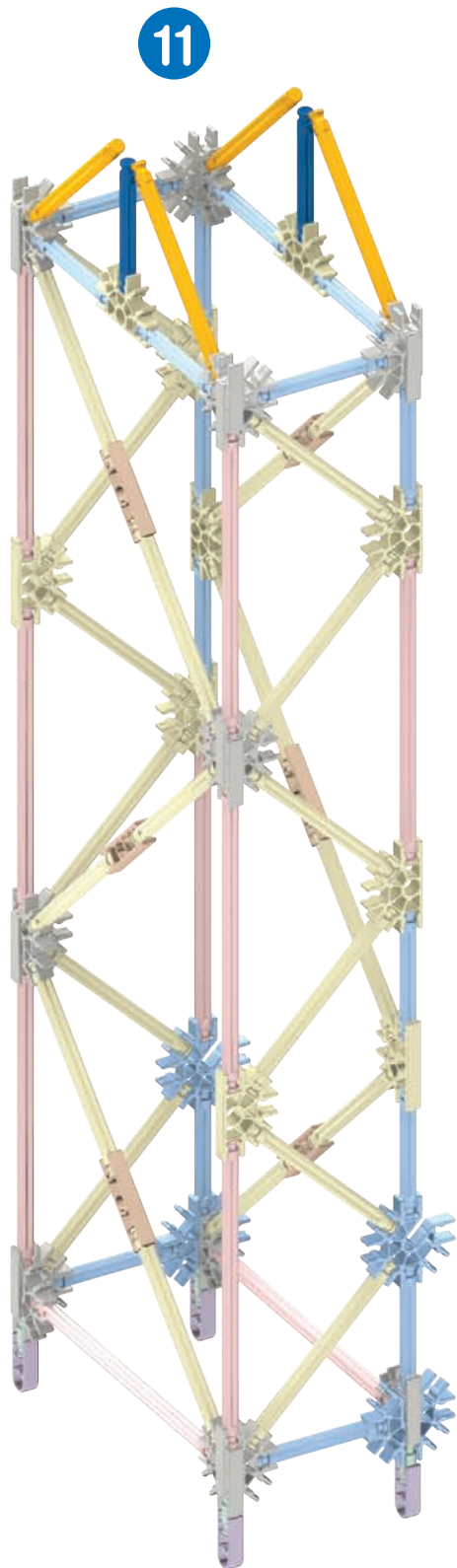

1 - 10

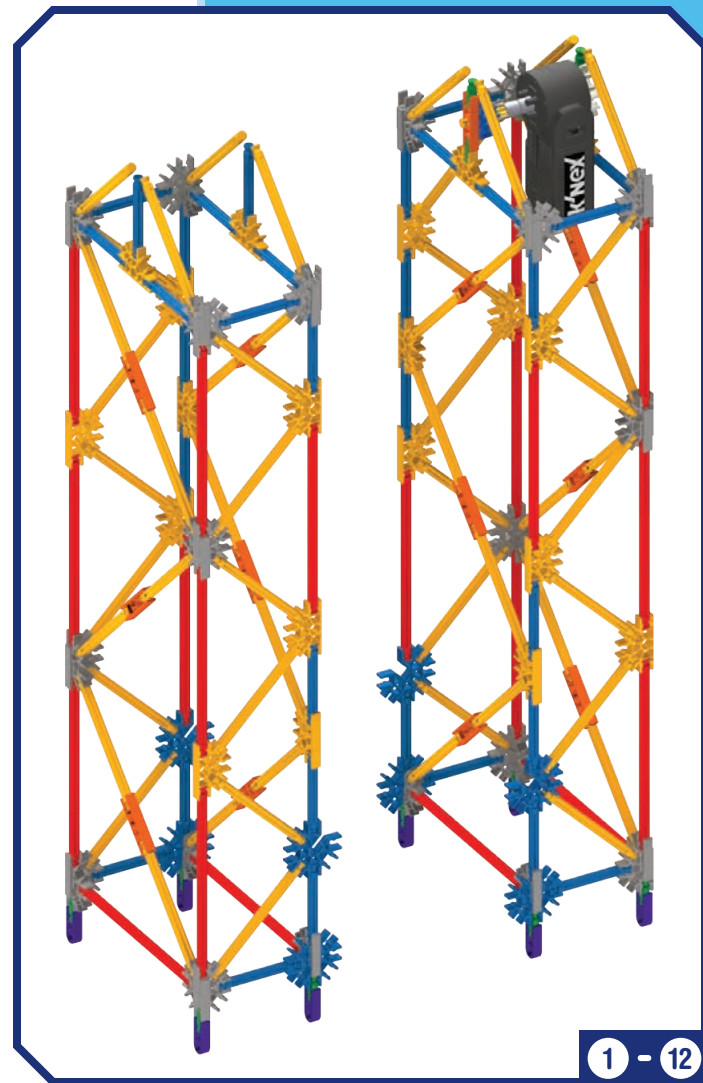

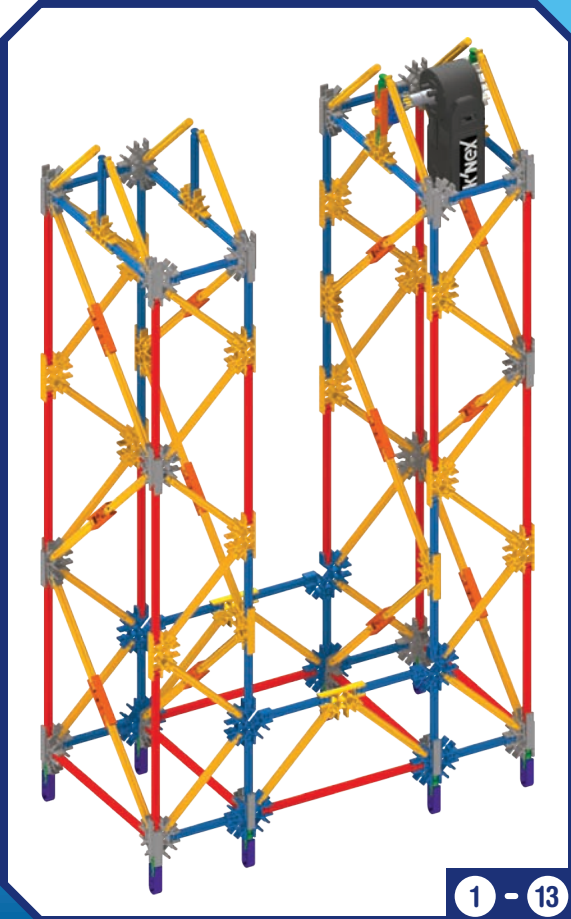
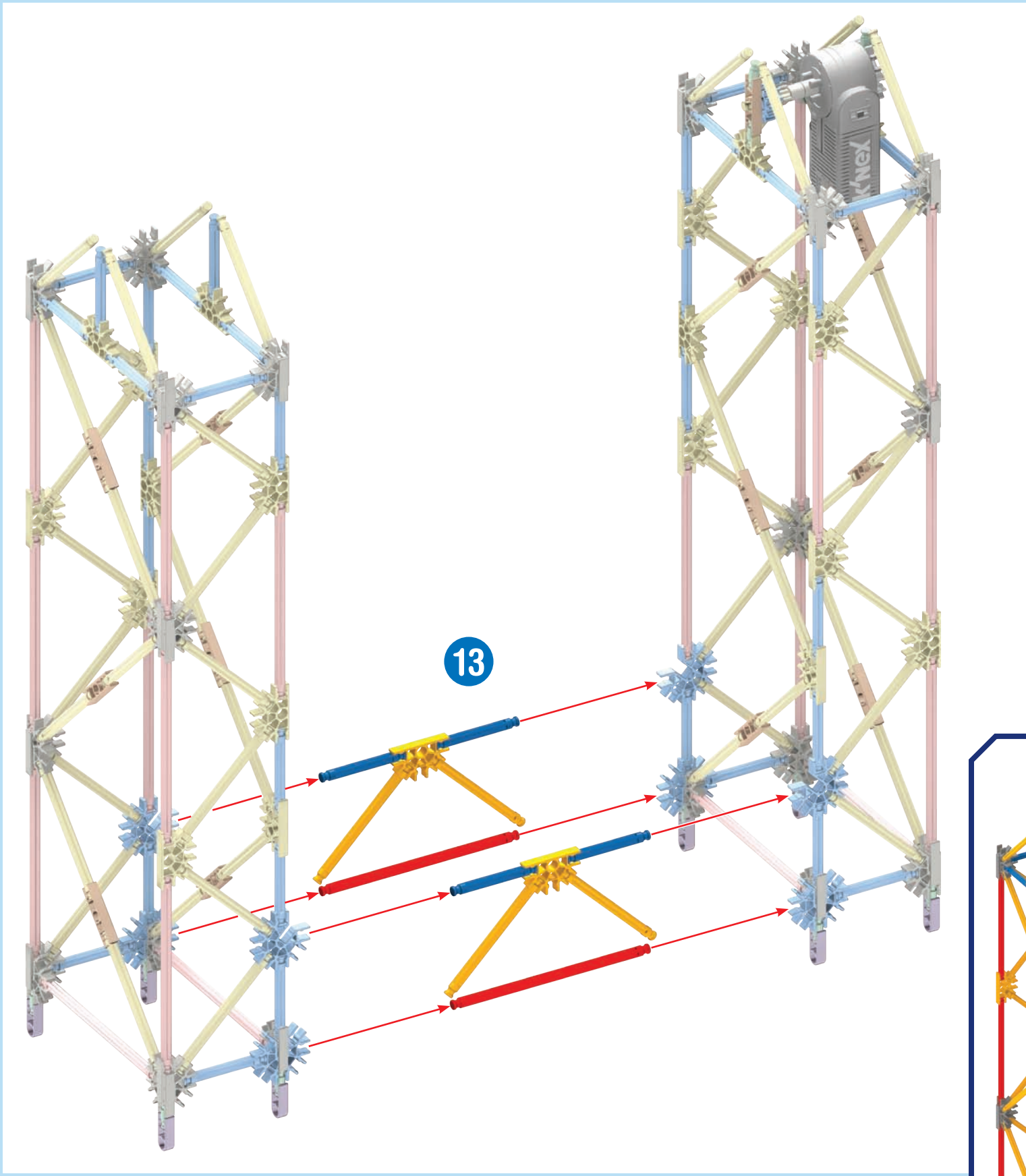

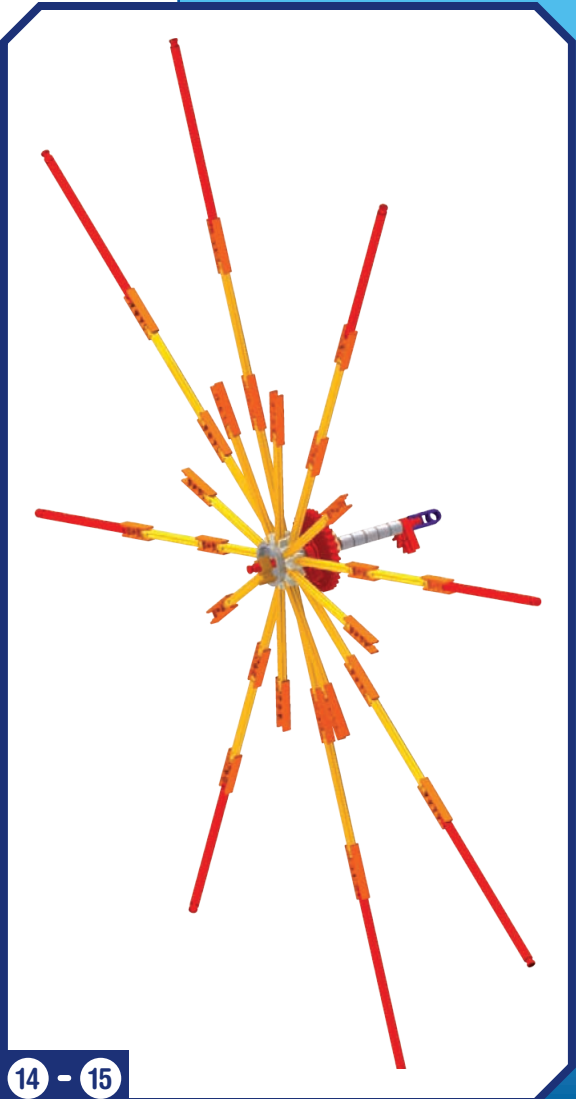
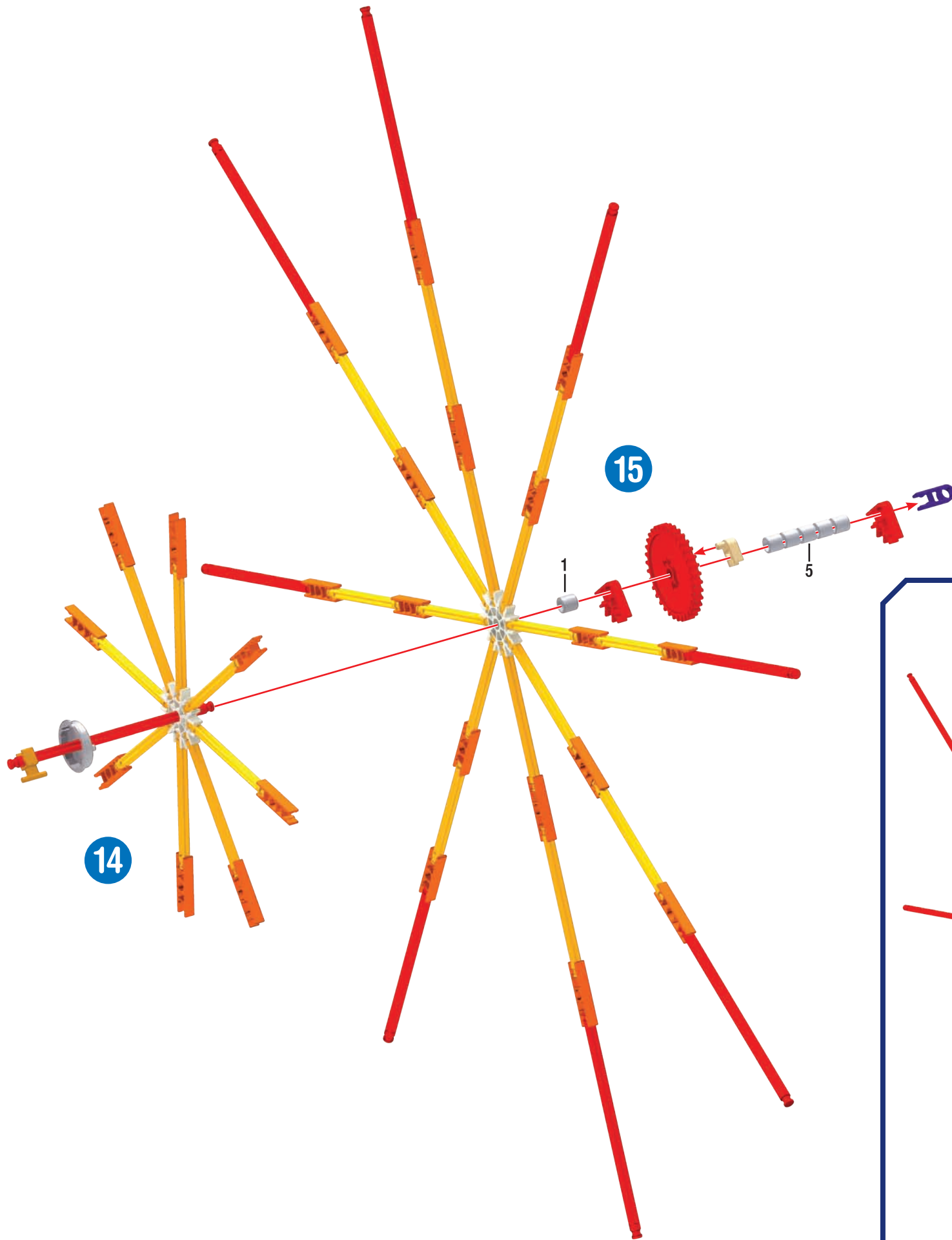

14 - 15

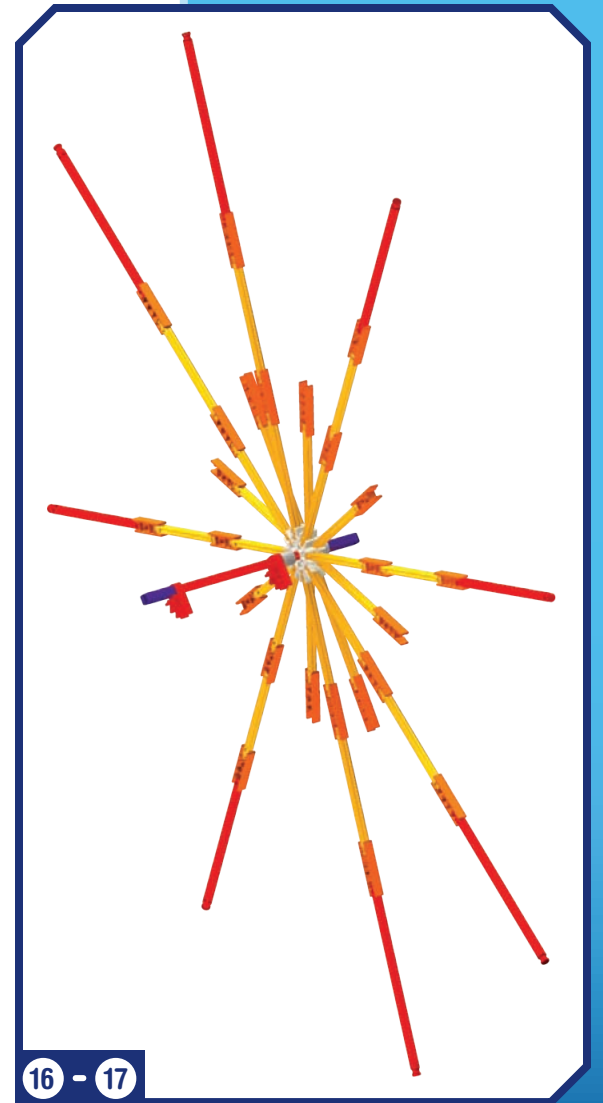
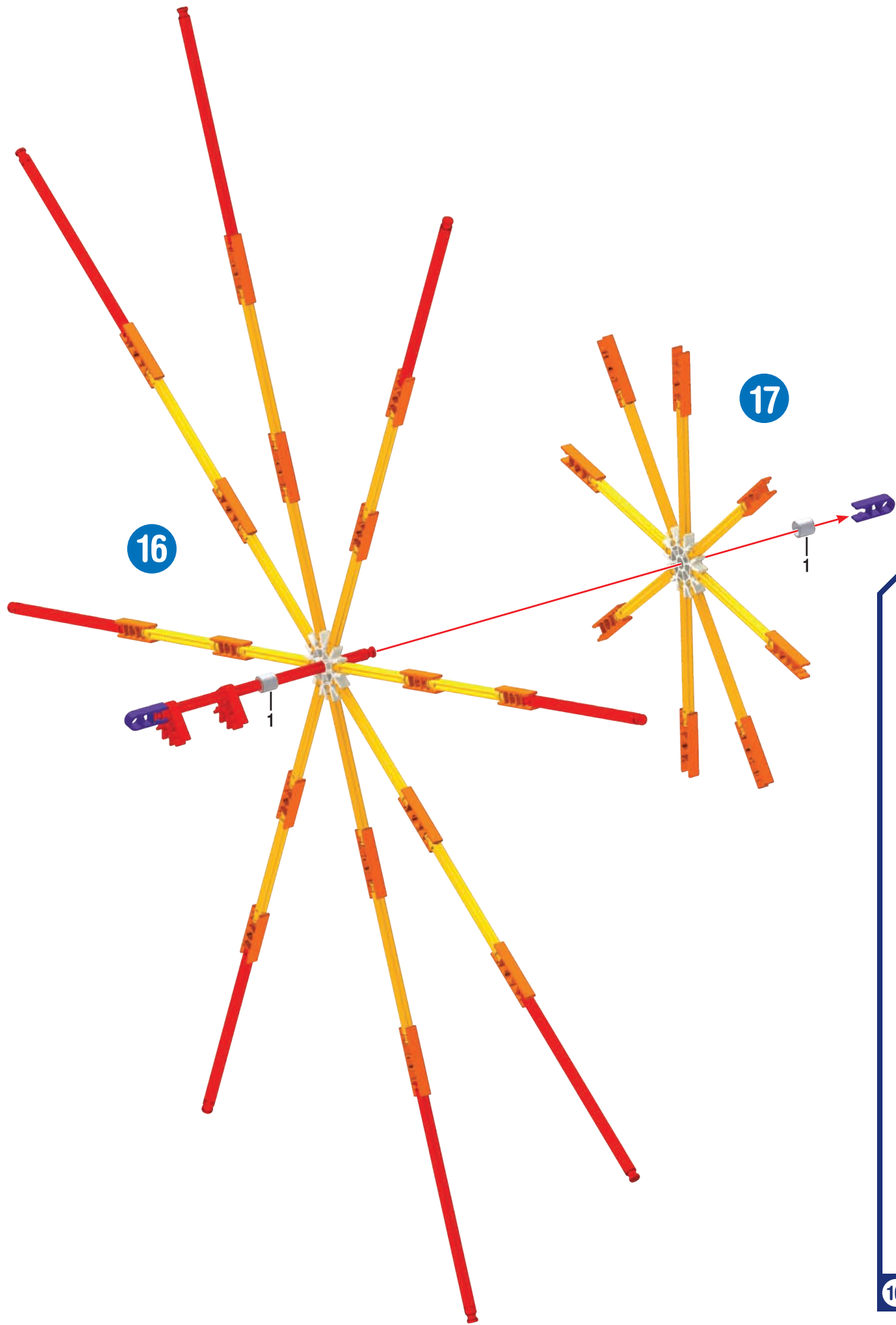

18

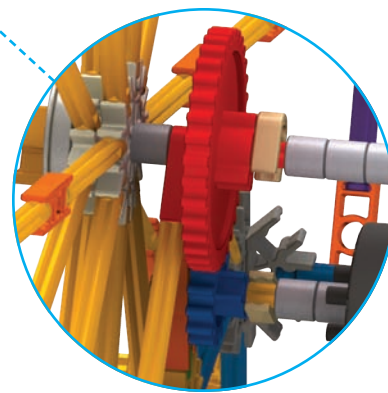
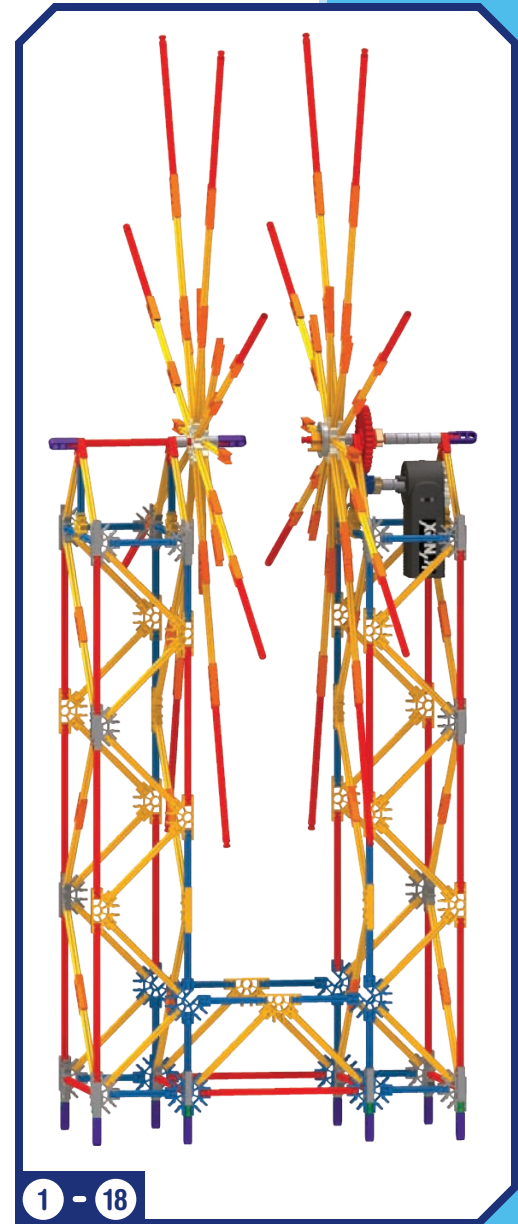
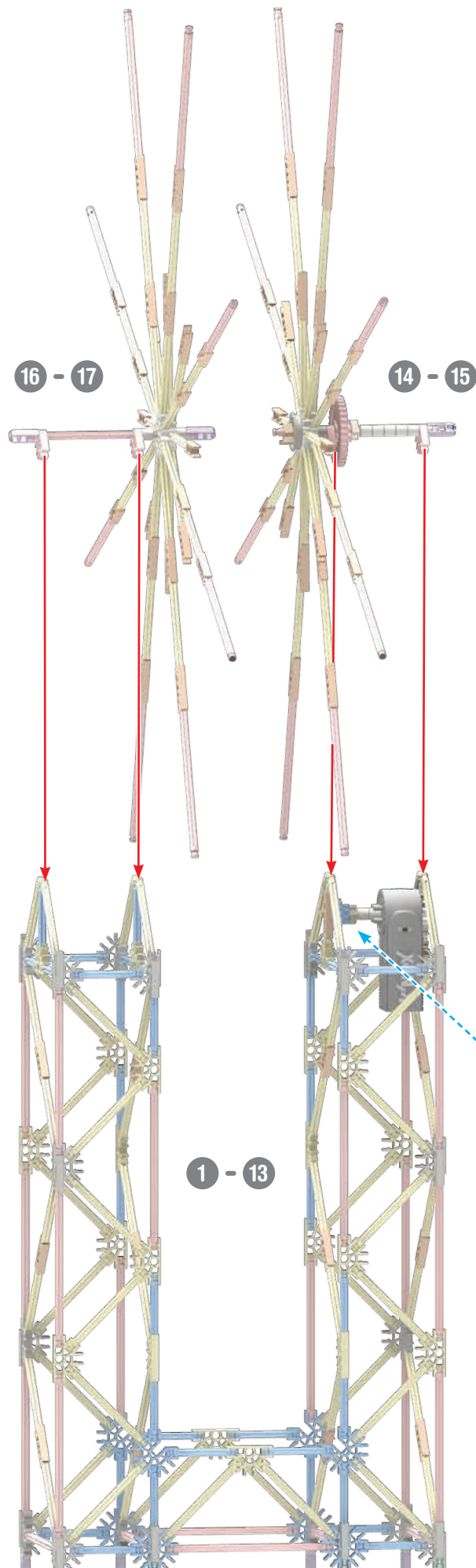

- (EN) Make sure the gears mesh.  
(FR) Vérifie que les engrenages s'enclenchent bien les uns dans les autres.  
(ES) Asegúrate de que los engranajes concuerdan.  
(DE) Vergewissere dich, dass die Zahnräder ineinander greifen.  
(IT) Assicurarsi gli ingranaggi ingranano.  
(PT) Assegure-se de que malha de engrenagens.  
(NL) Verzeker je ervan dat de tandwielen in mekaar passen.

x8

19

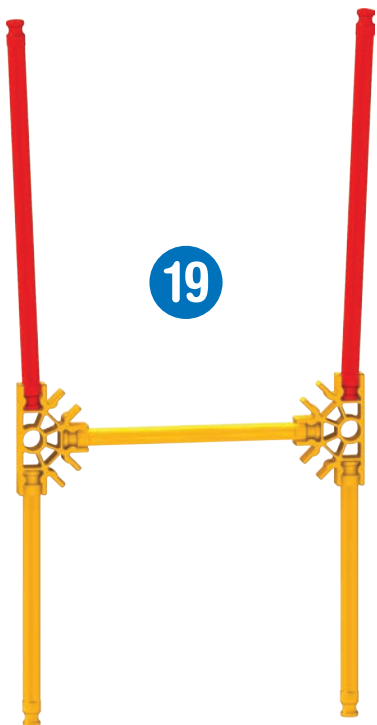

20



1 - 18

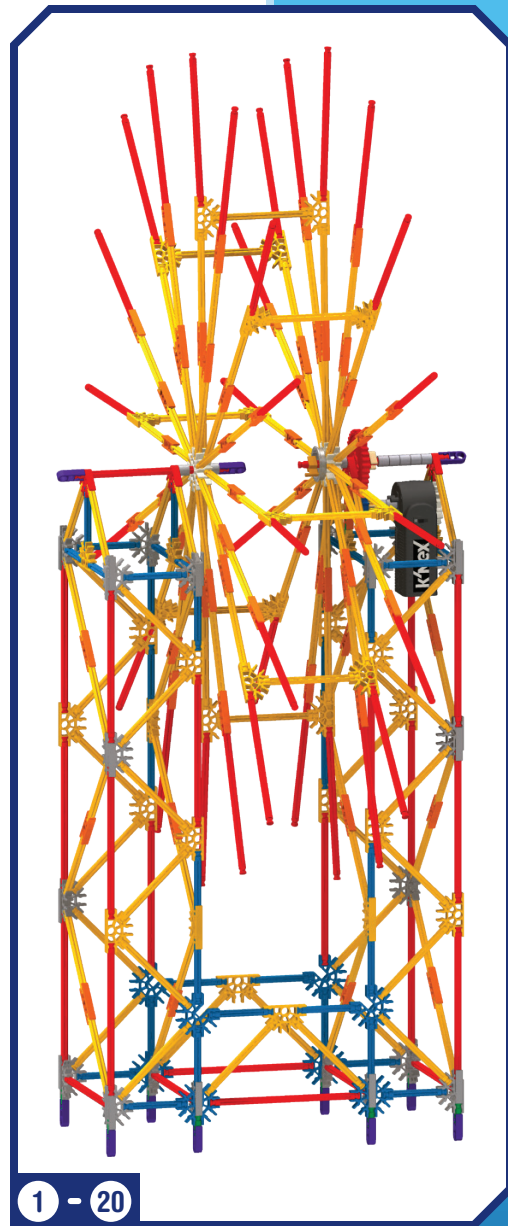

1 - 20

x12



21

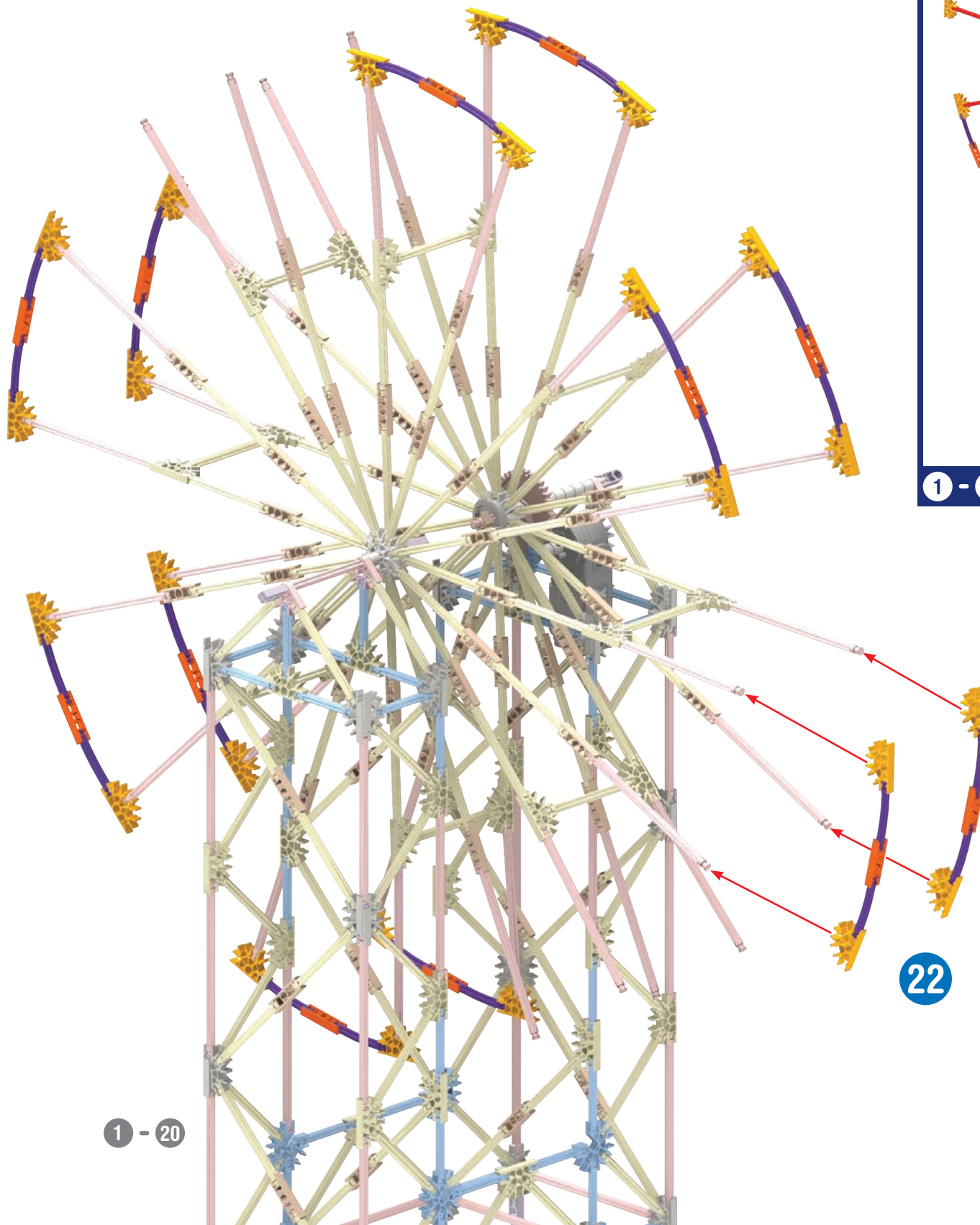

1 - 20

1 - 22

22

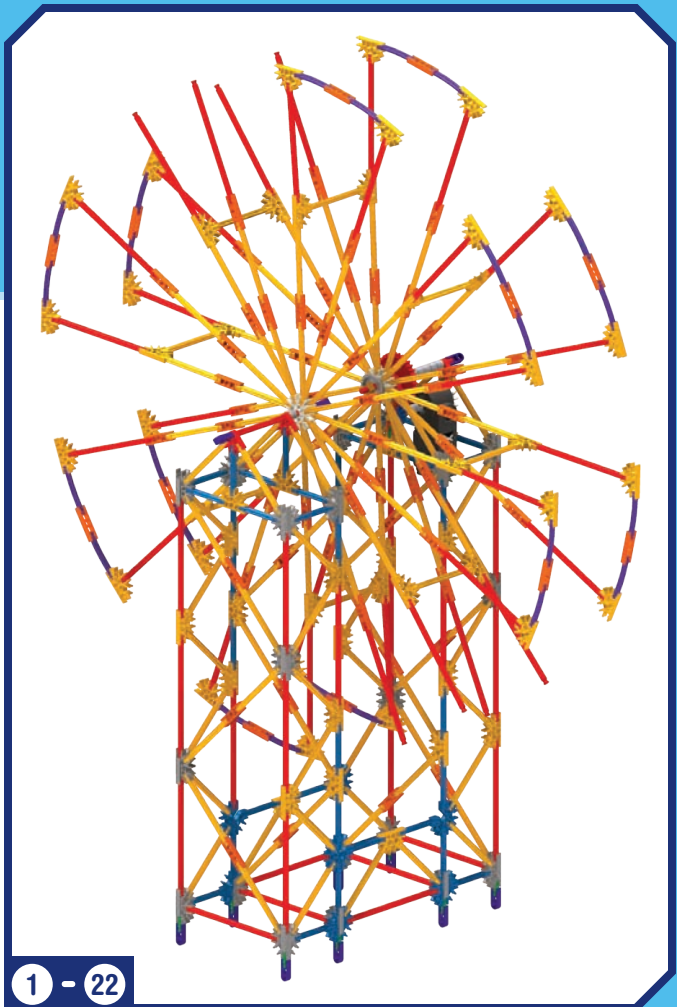

x2

23

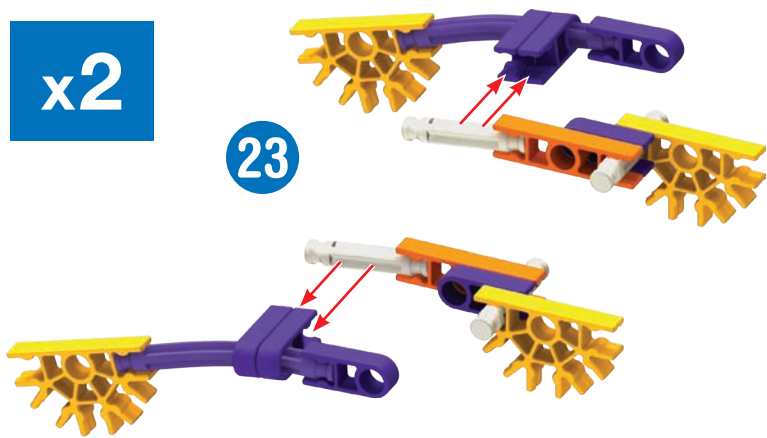

x2

23

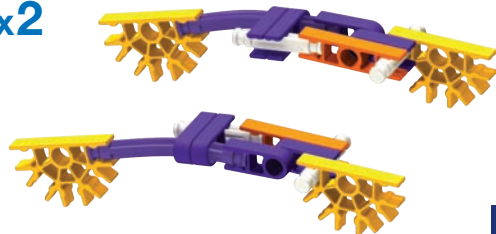

24

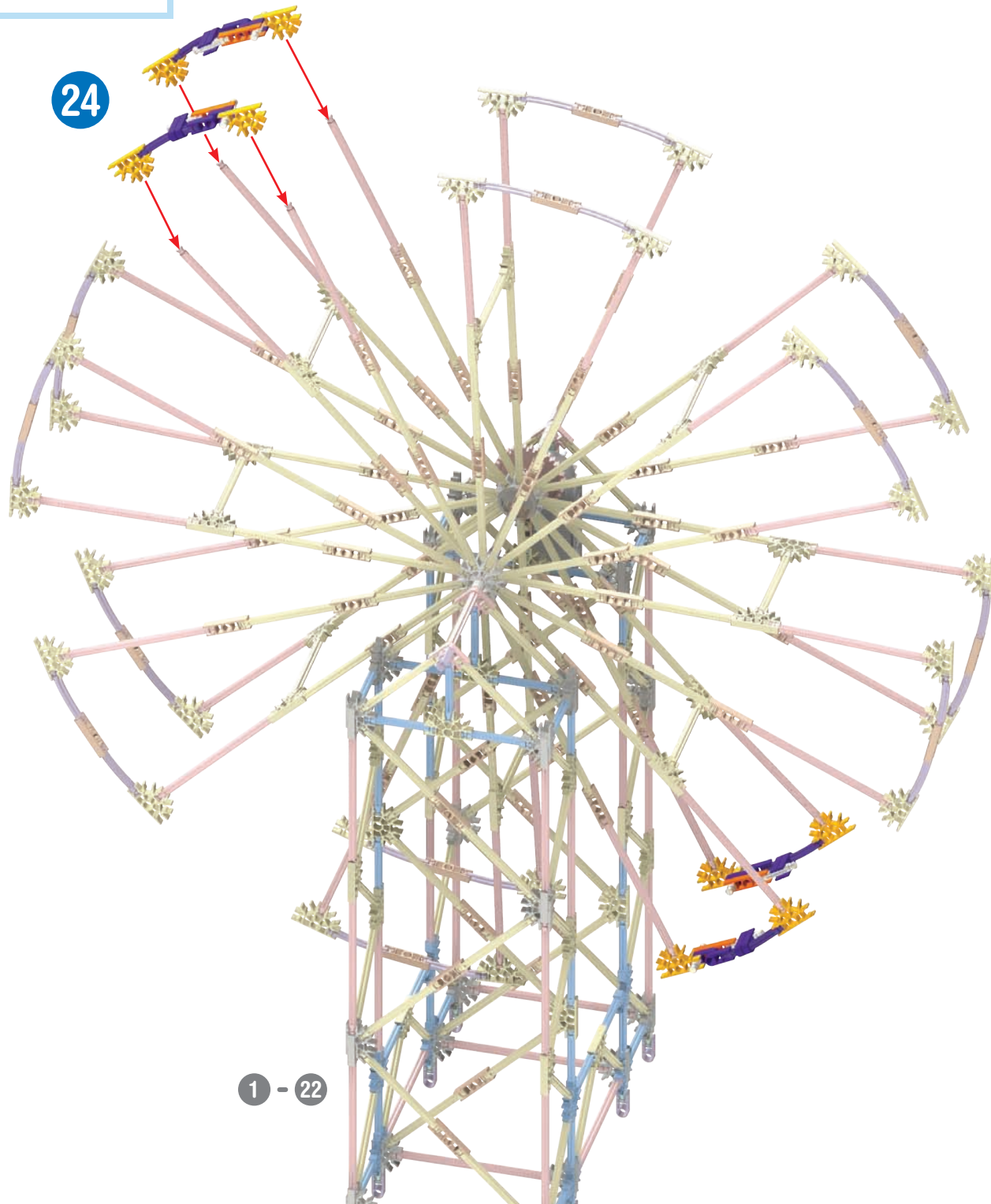

1 - 22

1 - 24



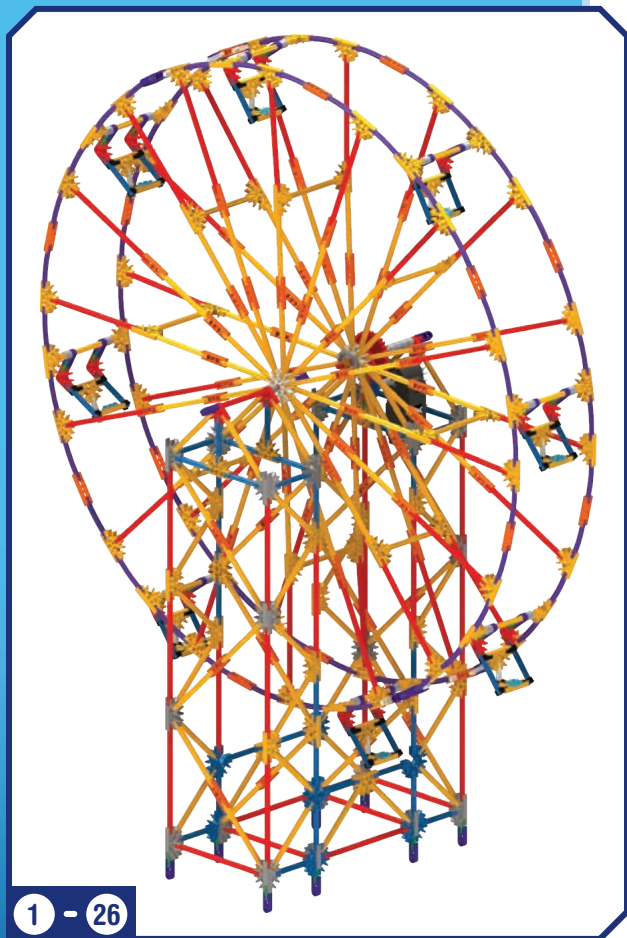

## PARTS LIST • Spin Ride

Before you start building, be sure to compare the parts in your set with the parts list here. If anything is missing, call or write to us using the information on the back cover. We are here to help you!

## LISTE DES PIÈCES • Tour de Tournoyer

Avant de commencer à construire, assure-toi de comparer les pièces dans ta boîte à la liste de pièces fournie ici. S'il manque quelque chose, téléphone-nous ou écris-nous en te servant des informations figurant au verso de la notice. Nous sommes là pour t'aider !

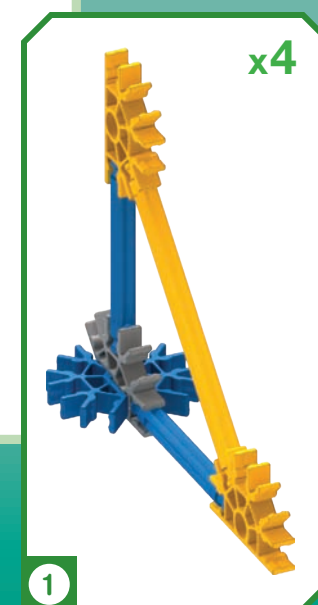
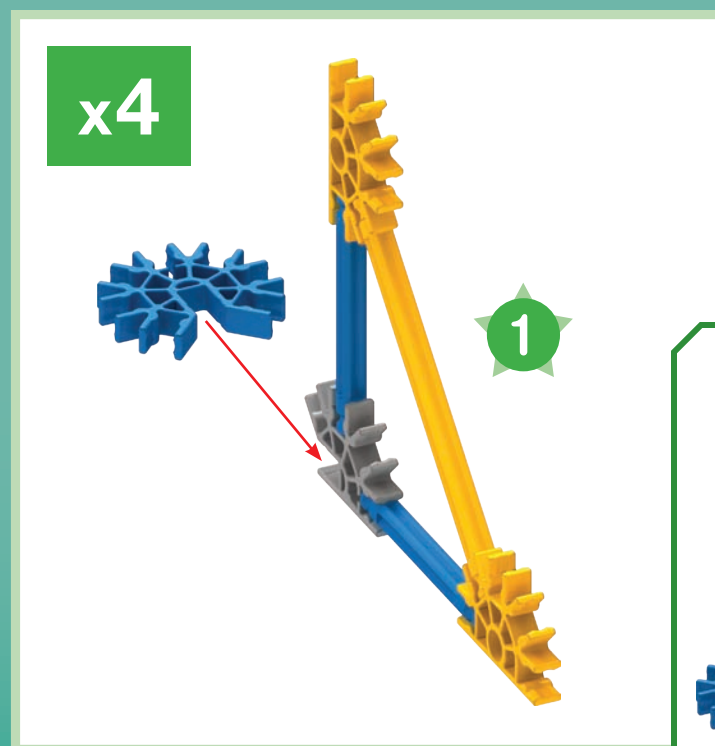
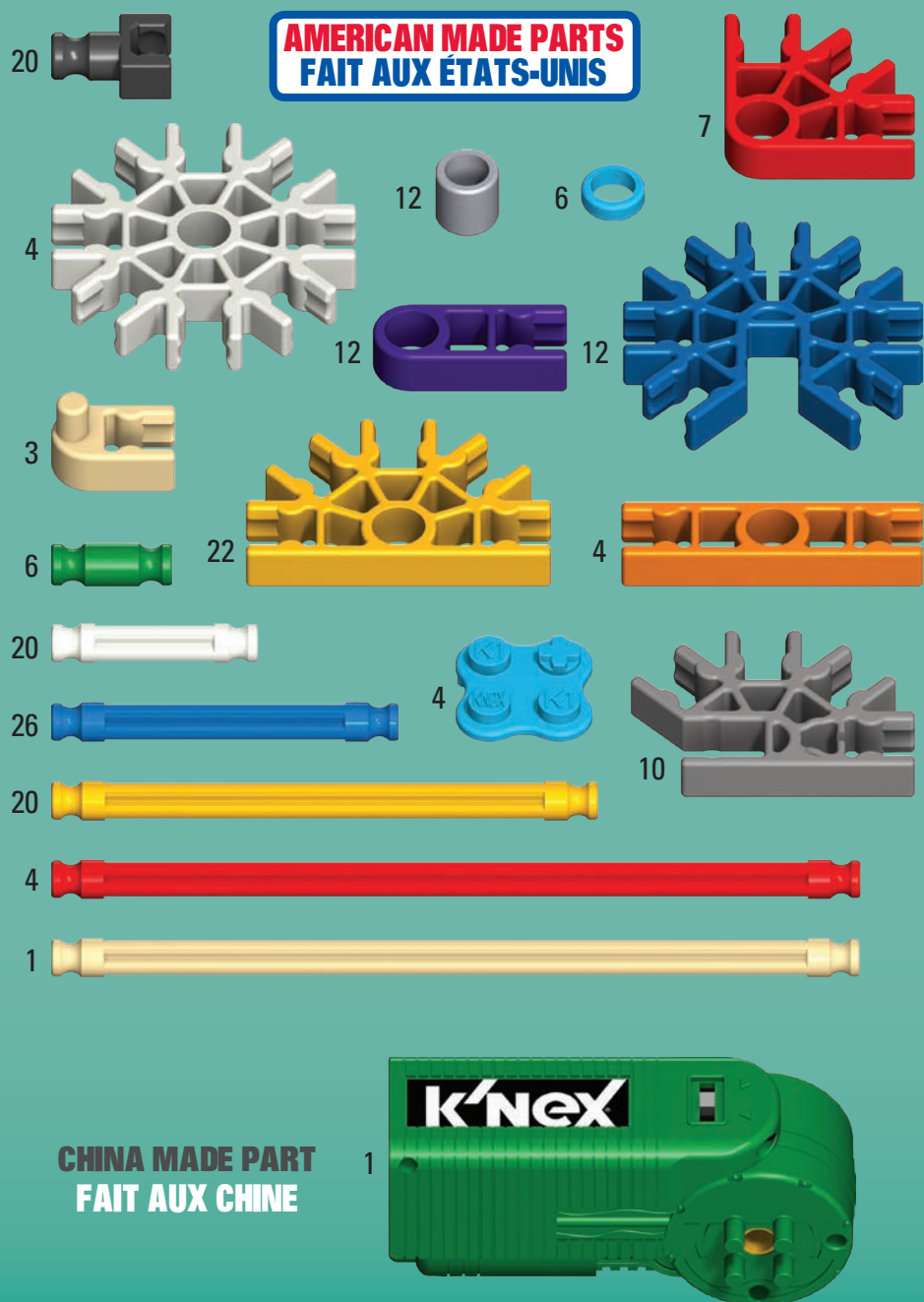

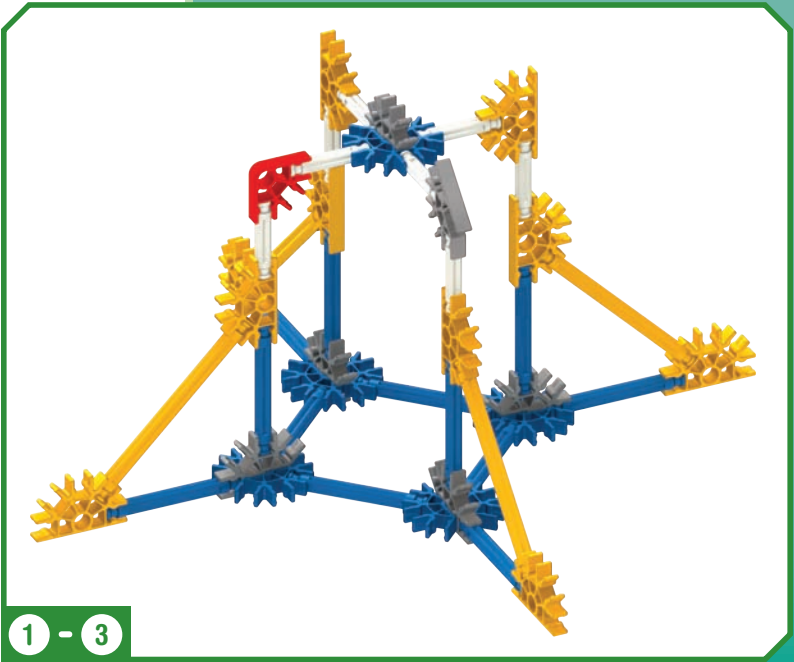
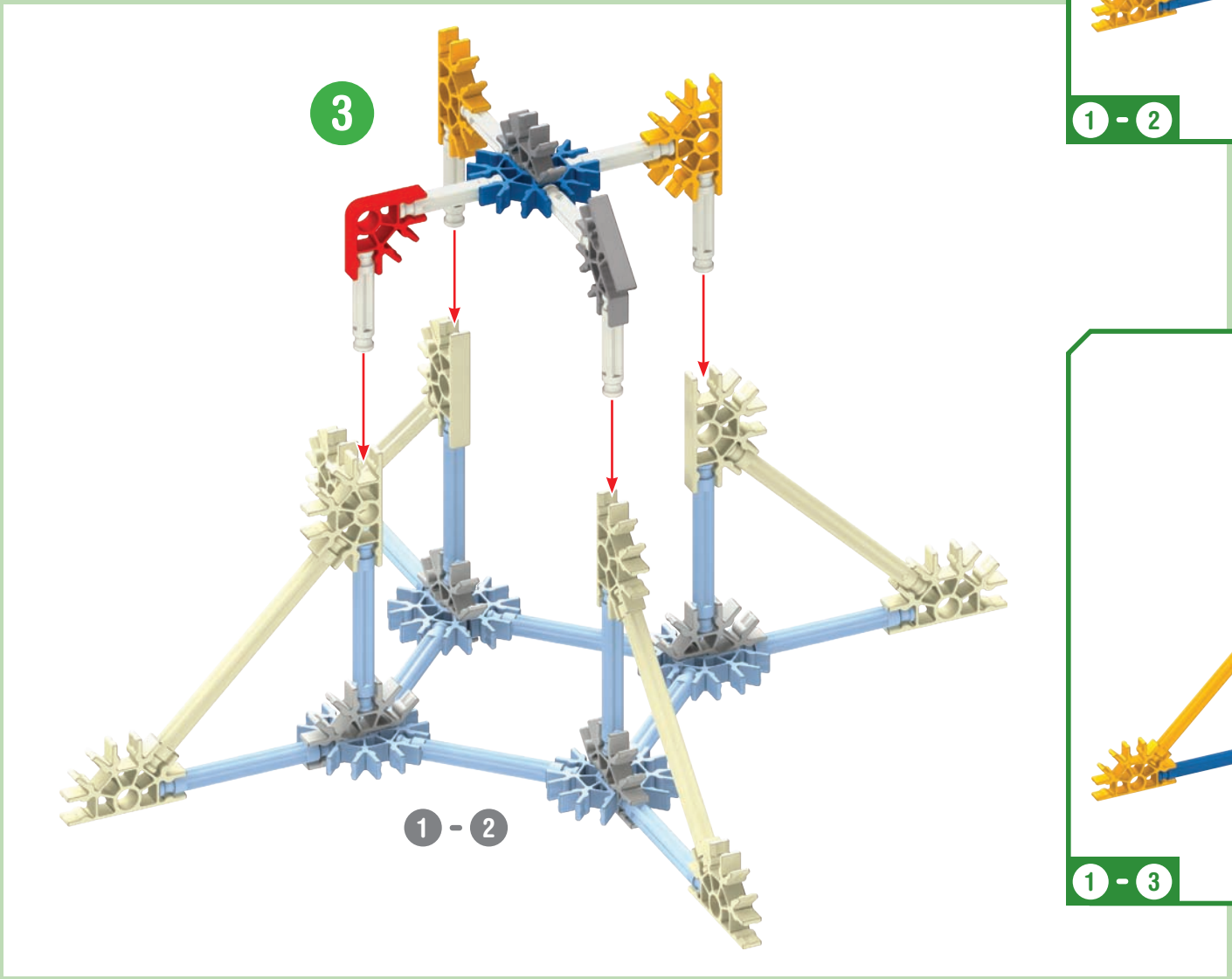
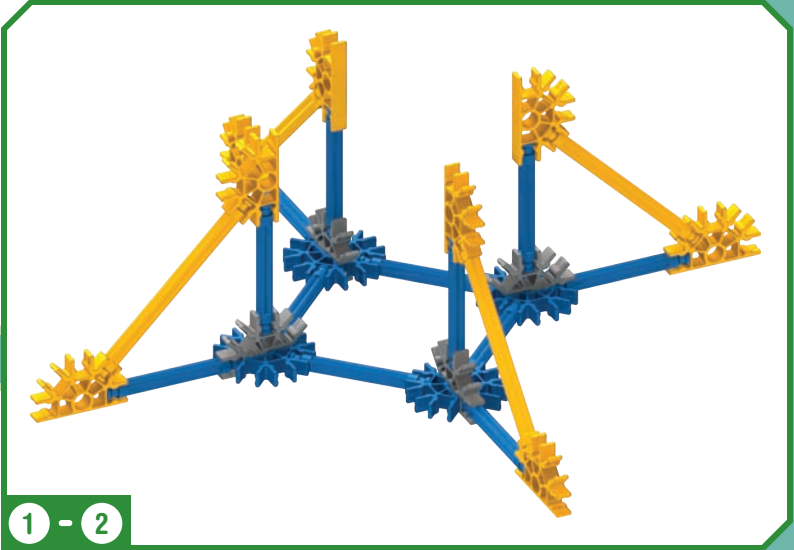
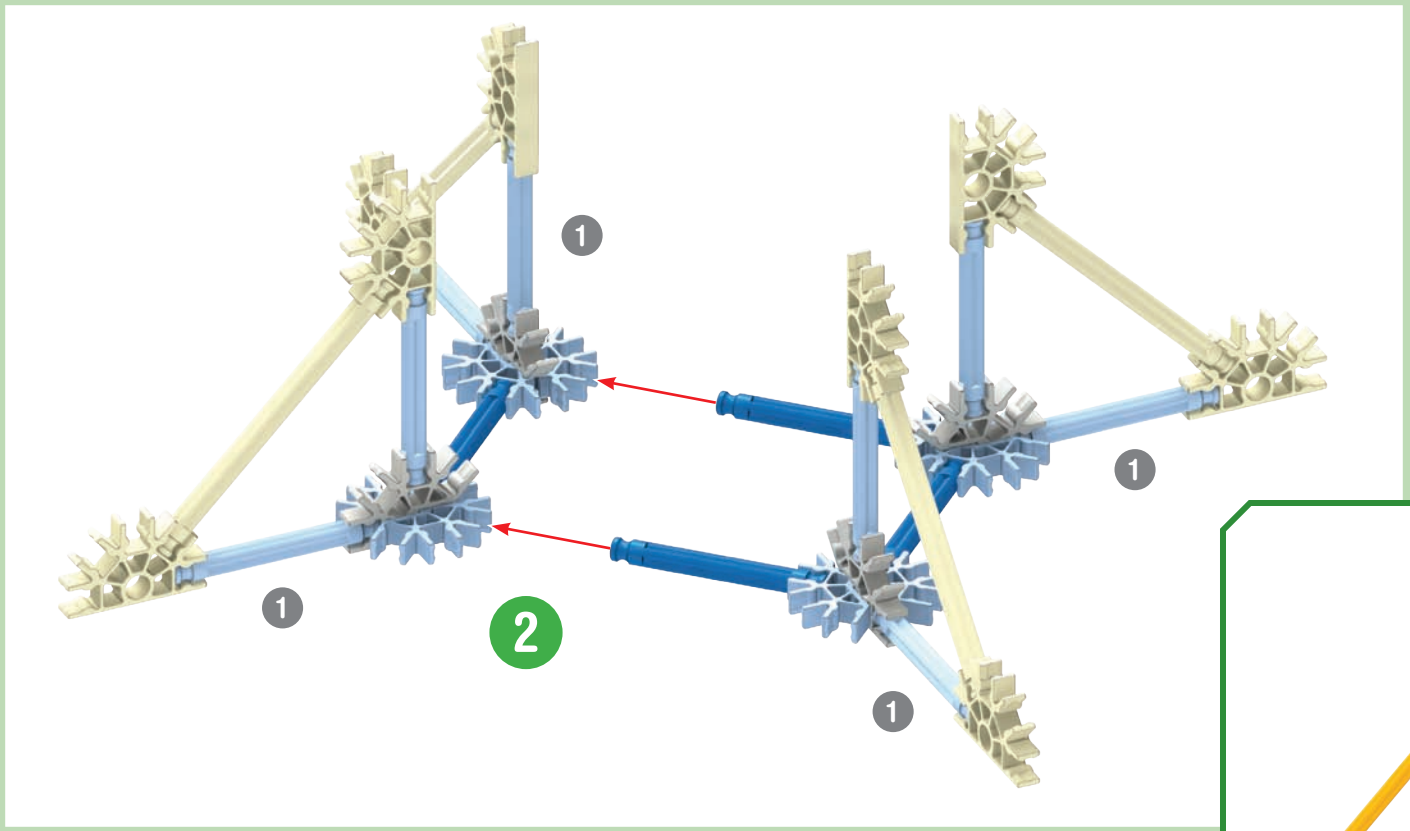

(EN) Did you install 2 AA (or LR6) batteries in the motor?

(FR) Avez-vous installé 2 piles AA (ou LR6) ?

(ES) ¿Instalaste 2 pilas AA (o LR6) en el motor?

(DE) Hast du 2 AA (oder LR6) Batterien in den Motor eingelegt?

(IT) Hai installato 2 batterie AA (o LR6) nel motore?

(PT) Foram instaladas as pilhas 2 AA (ou LR6) no motor?

(NL) Heb je 2 AA (of LR6)-batterijen in de motor geplaatst?

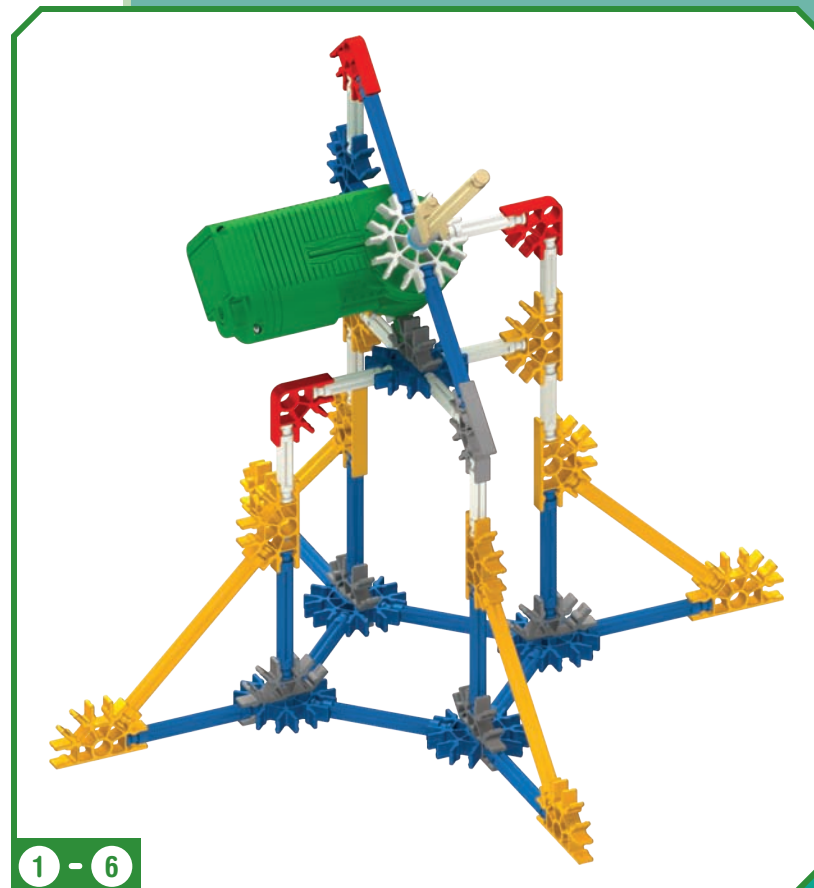
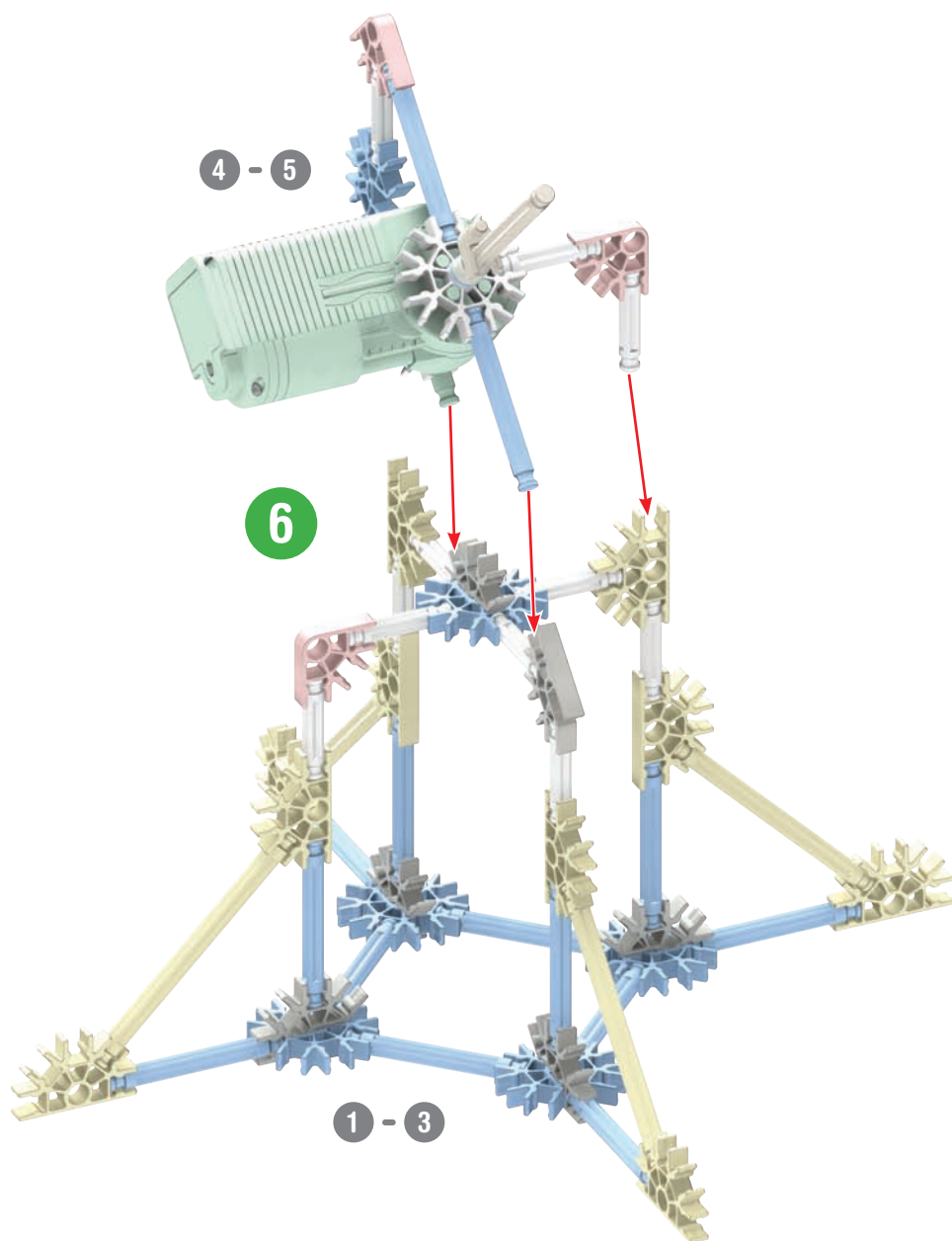
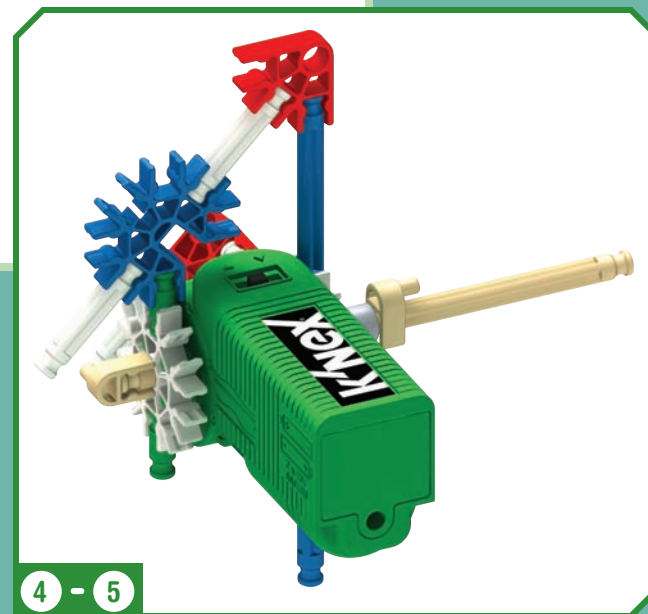
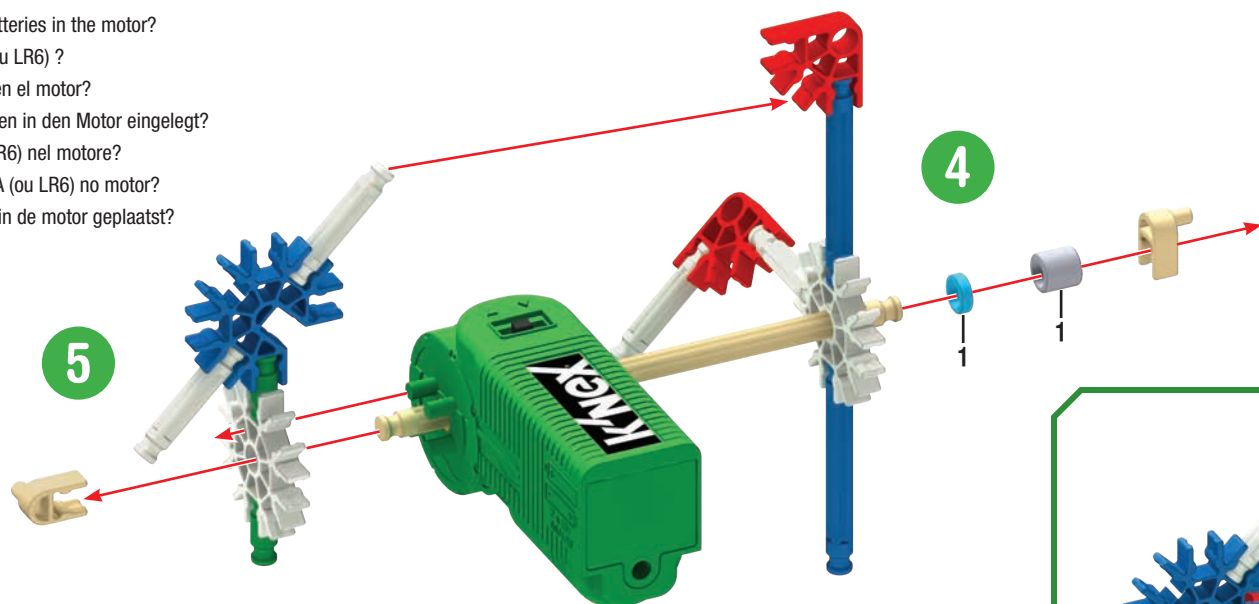

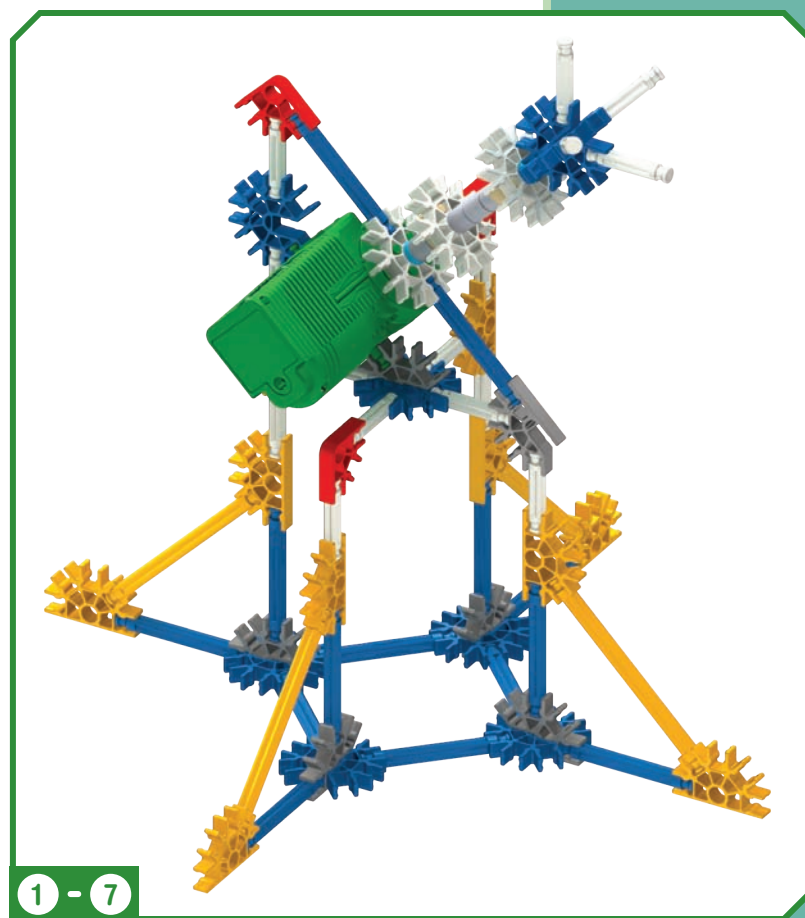
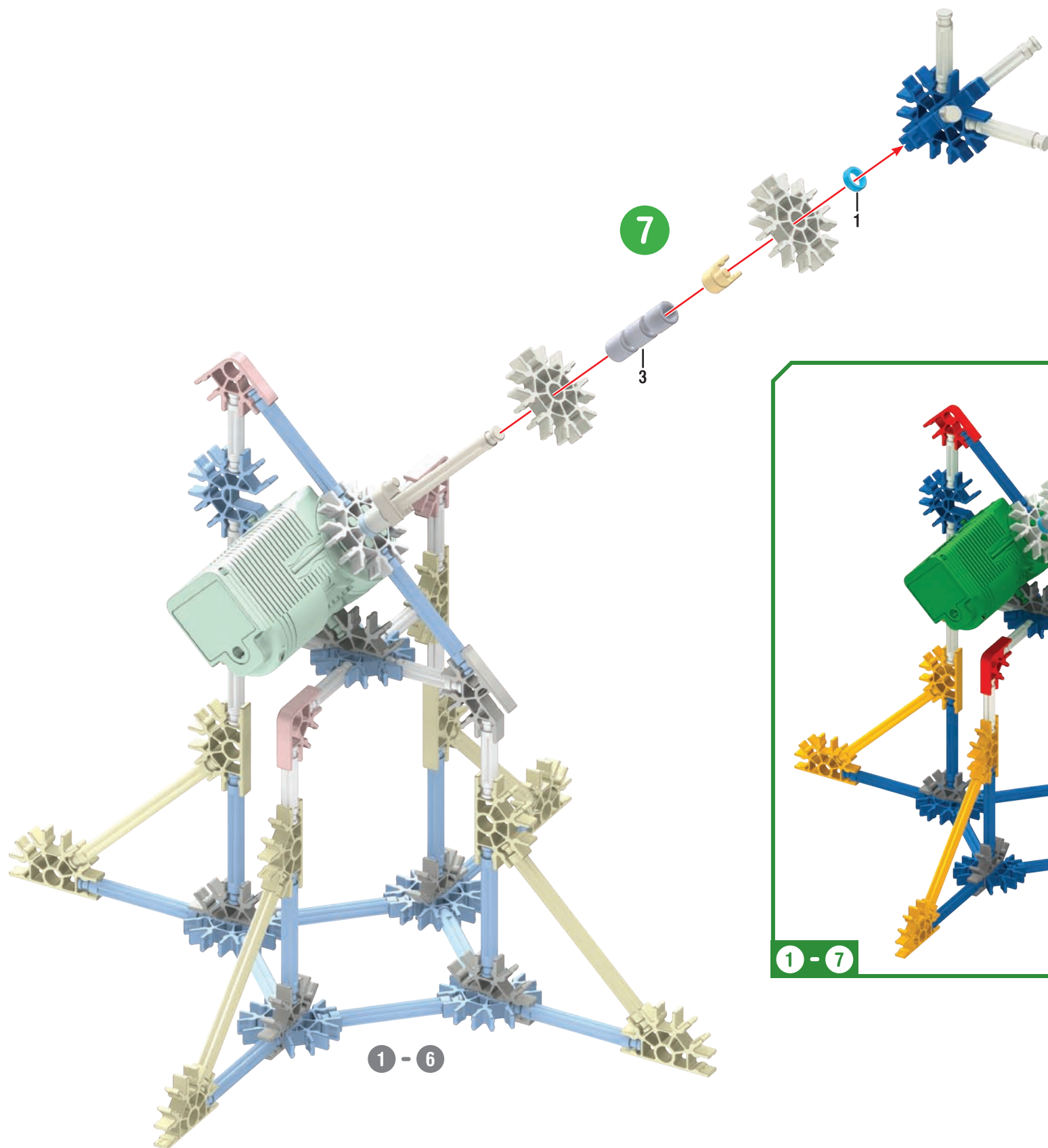

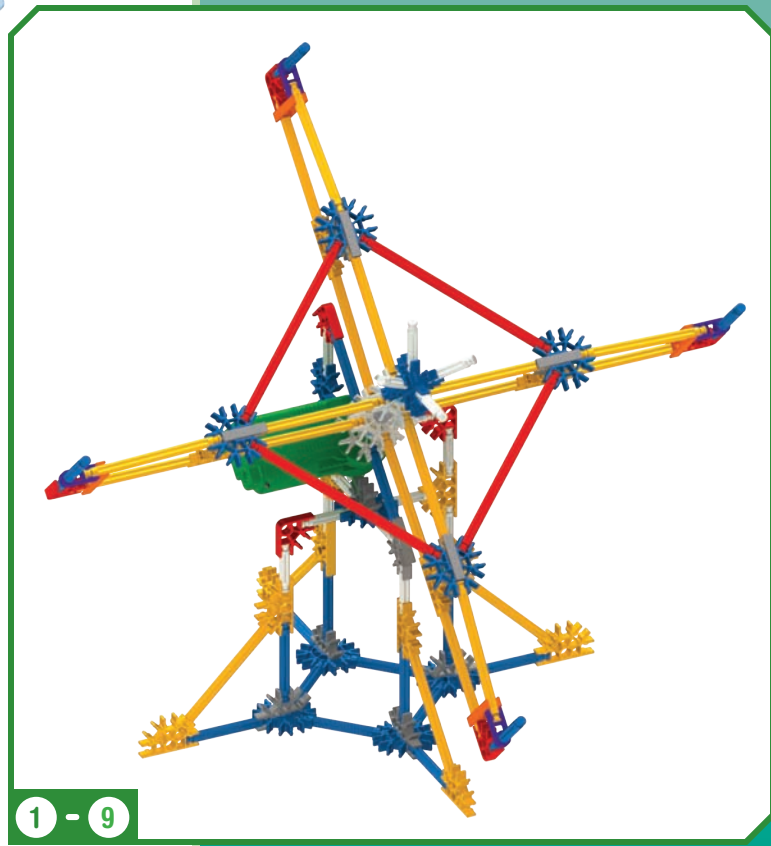
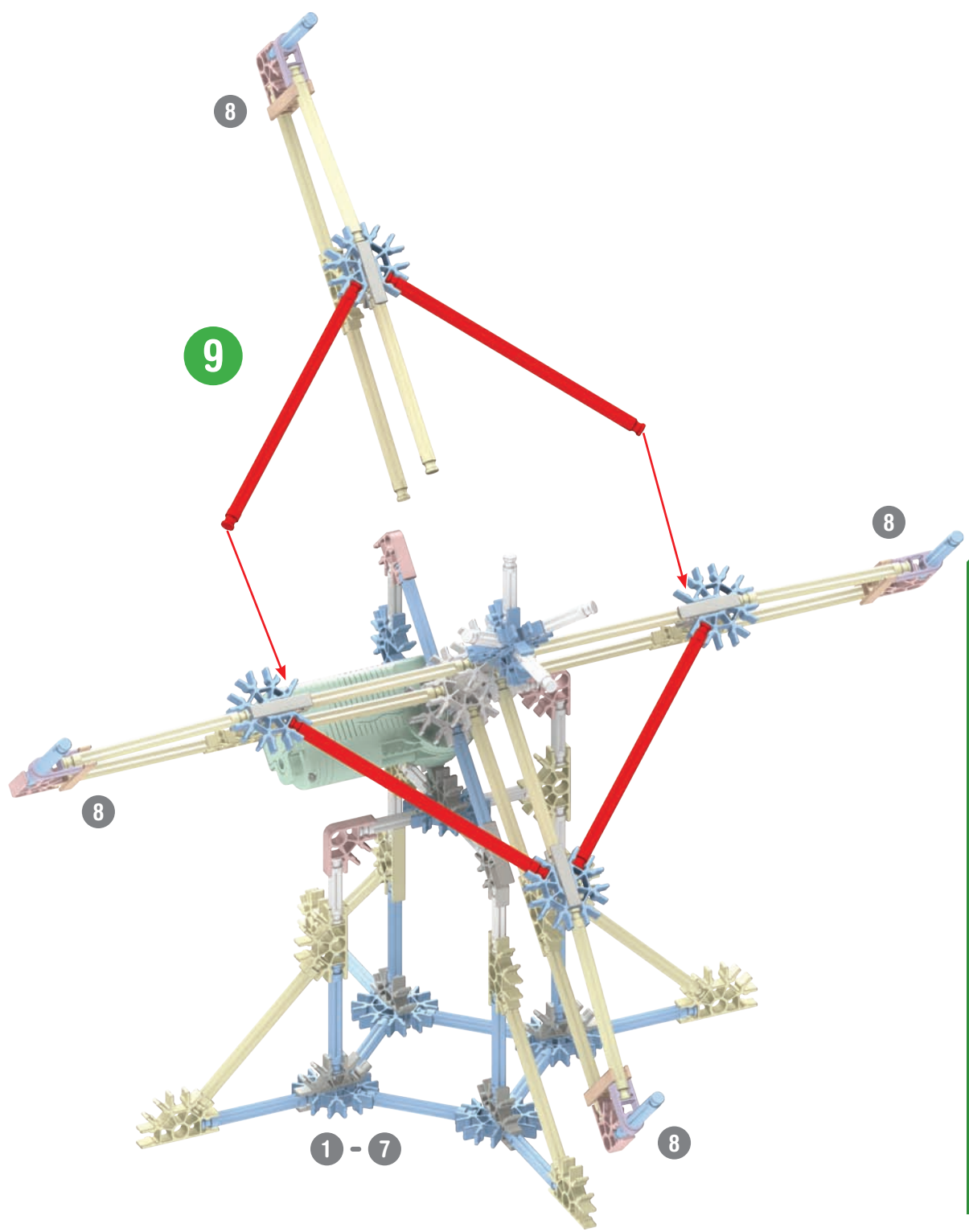
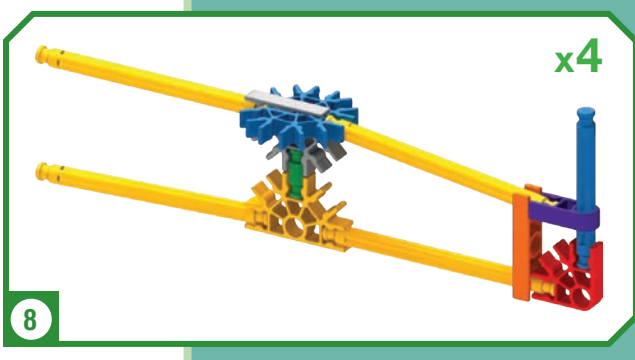
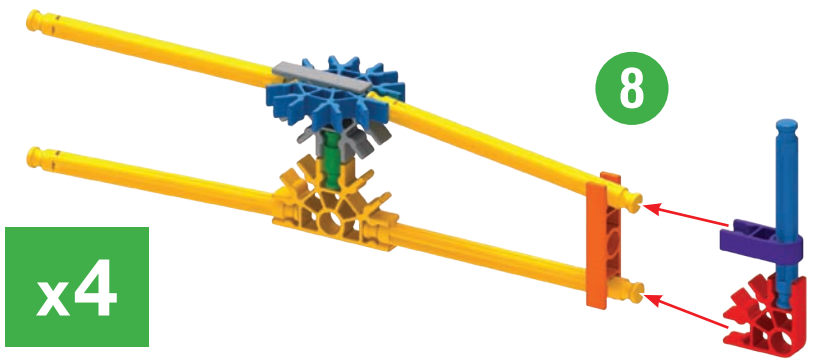

x4

10

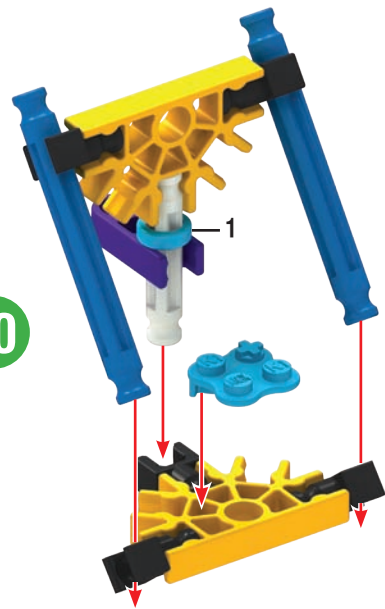

10

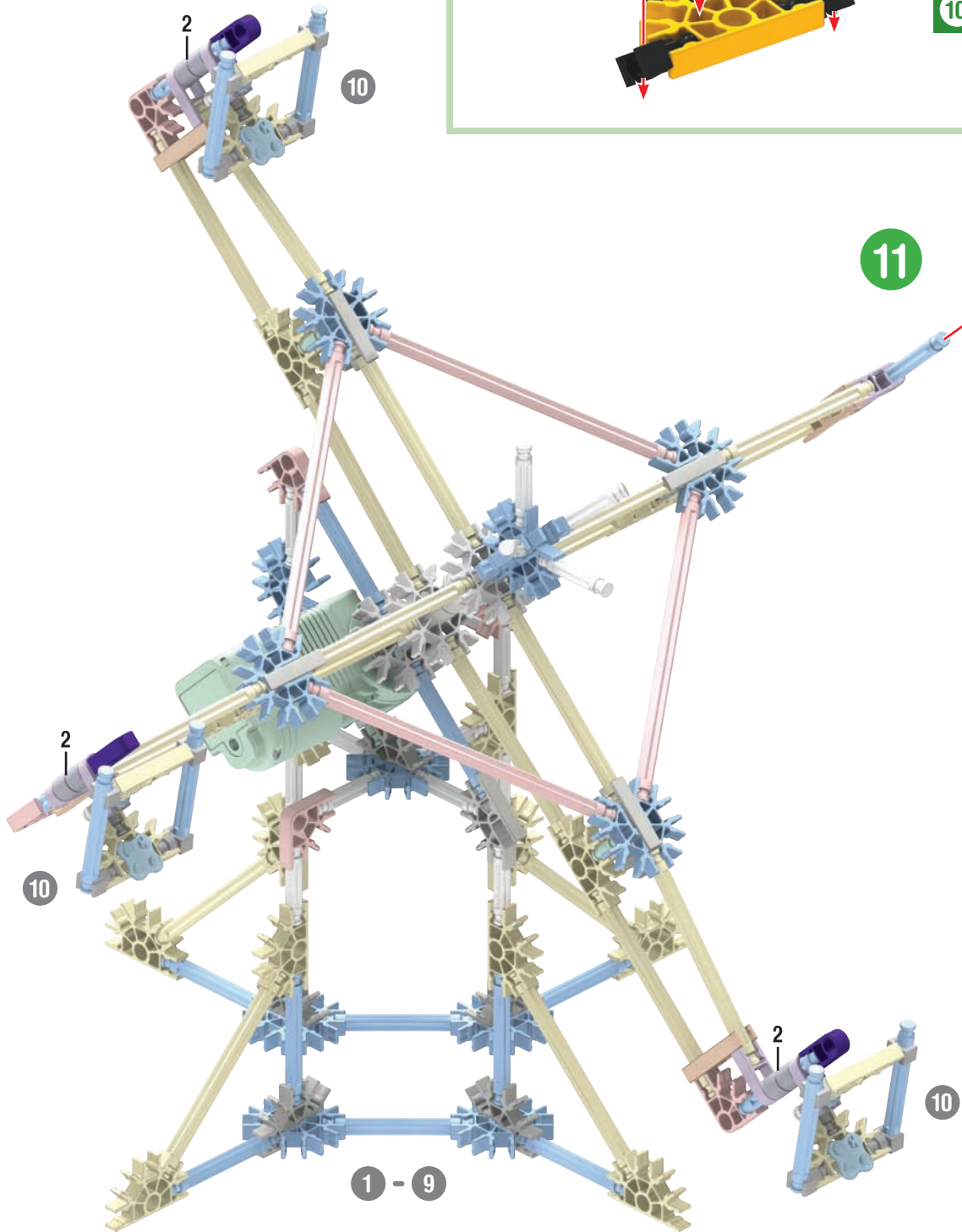

11

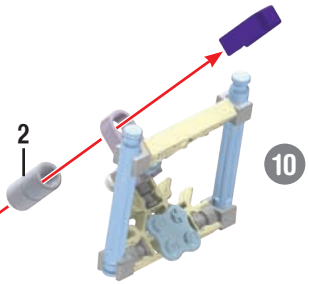

1 - 11

# TUMBLING TORNADO TORNADE EN TOMBANT



## PARTS LIST • Tumbling Tornado

Before you start building, be sure to compare the parts in your set with the parts list here. If anything is missing, call or write to us using the information on the back cover. We are here to help you!

## LISTE DES PIÈCES • Tornade en Tombant

Avant de commencer à construire, assure-toi de comparer les pièces dans ta boîte à la liste de pièces fournie ici. S'il manque quelque chose, téléphone-nous ou écris-nous en te servant des informations figurant au verso de la notice. Nous sommes là pour t'aider !

### CHINA MADE PARTS FAIT AUX CHINE



### AMERICAN MADE PARTS FAIT AUX ETATS-UNIS



x2

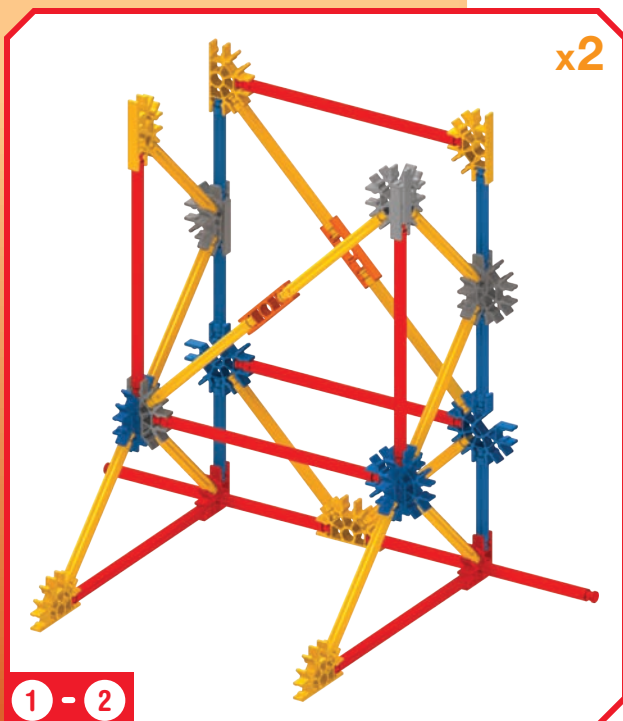

1 - 2

x2

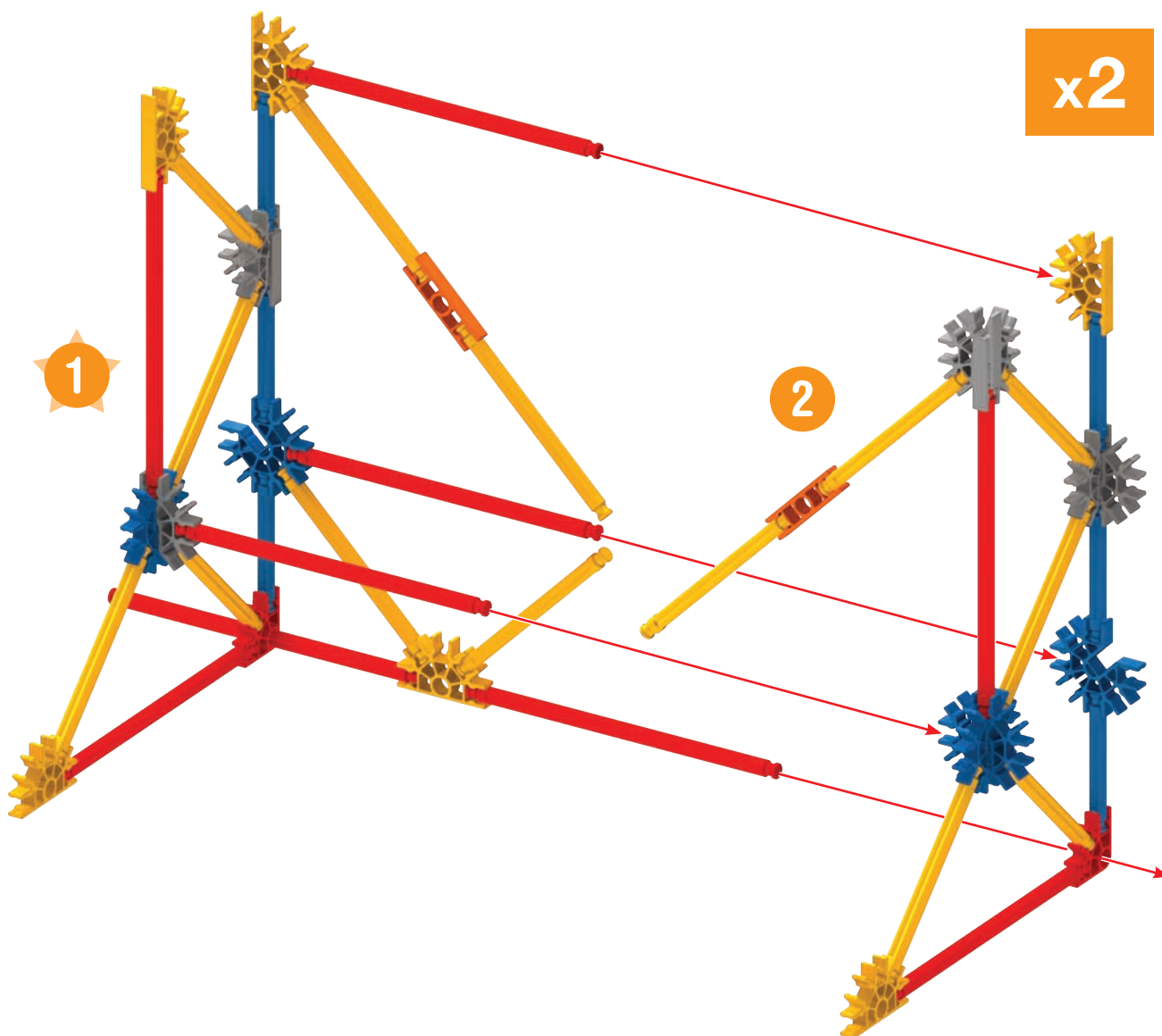

x2

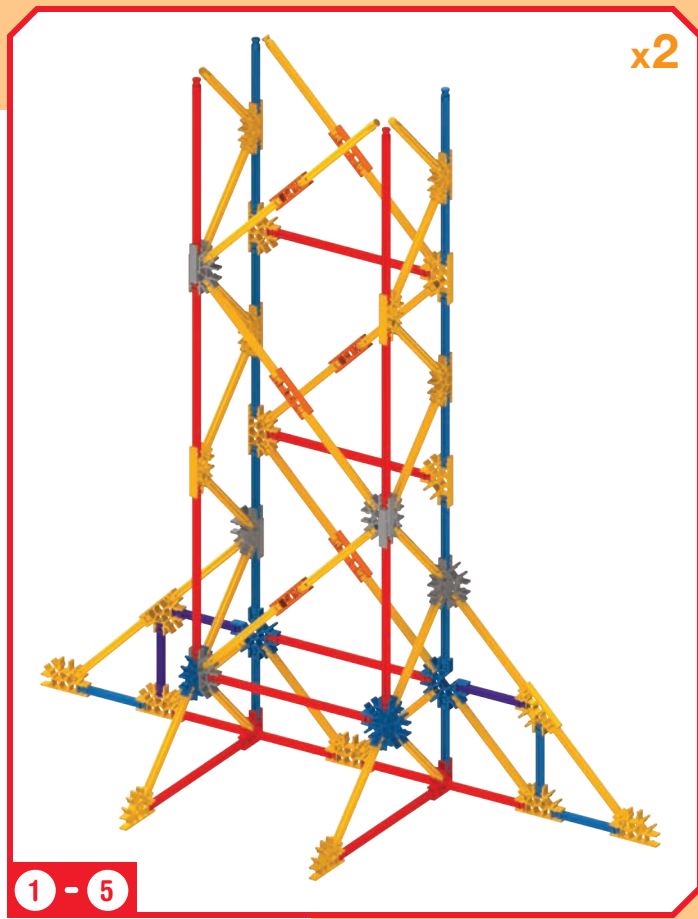
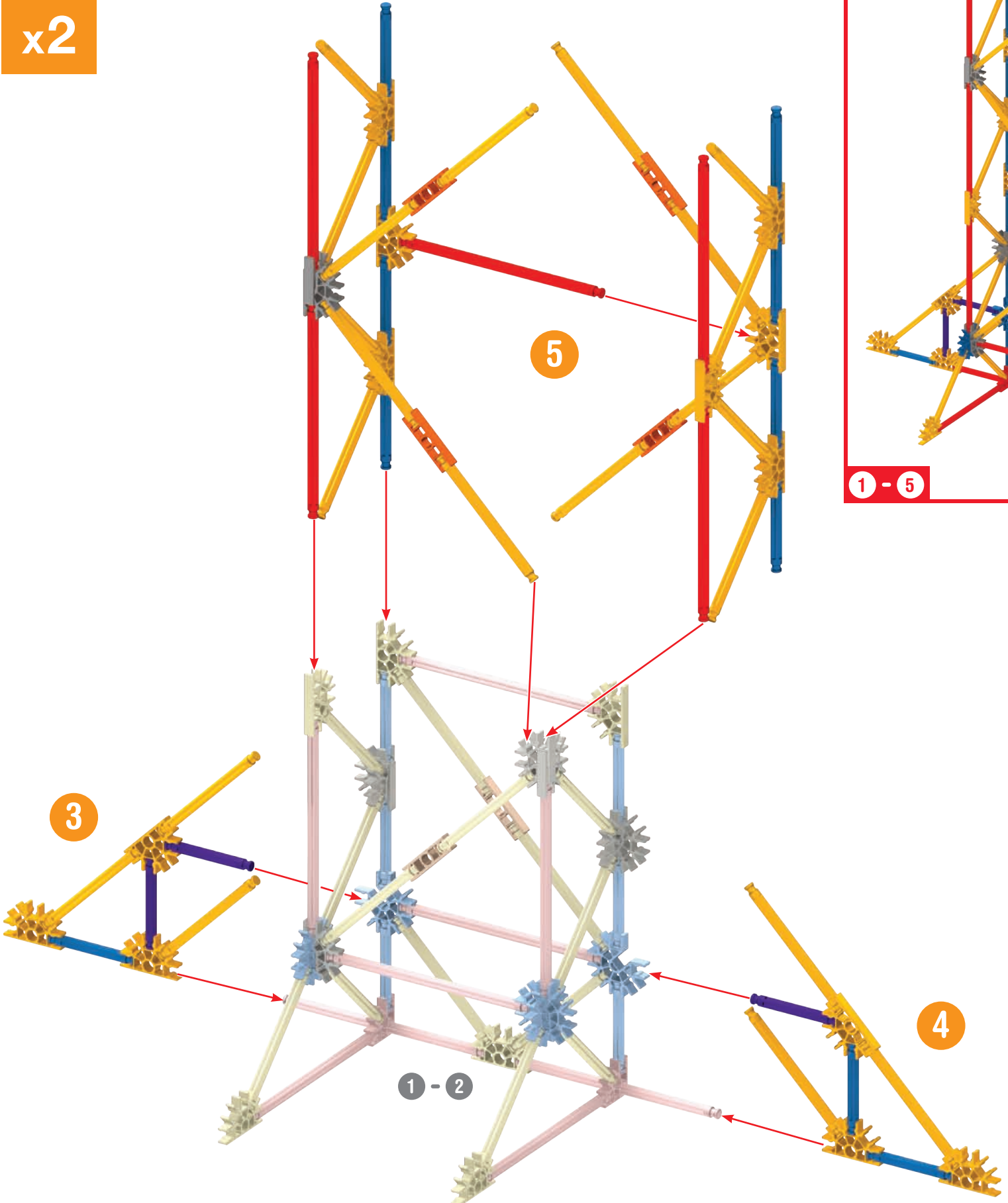

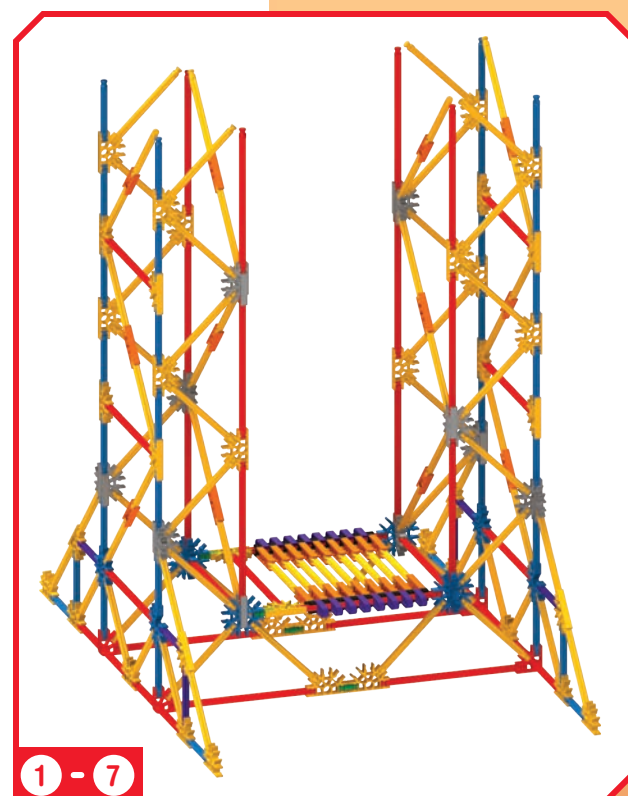
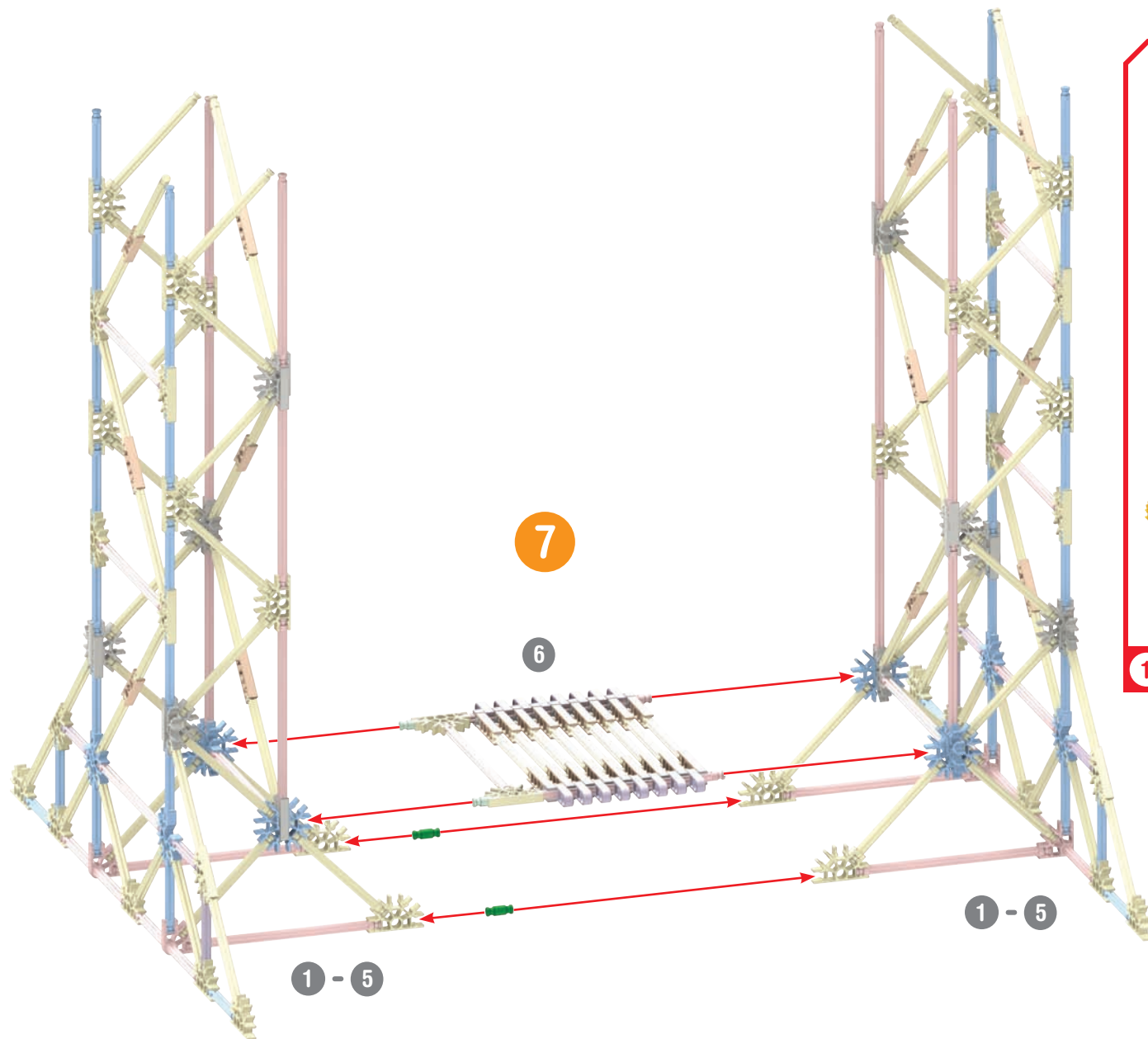
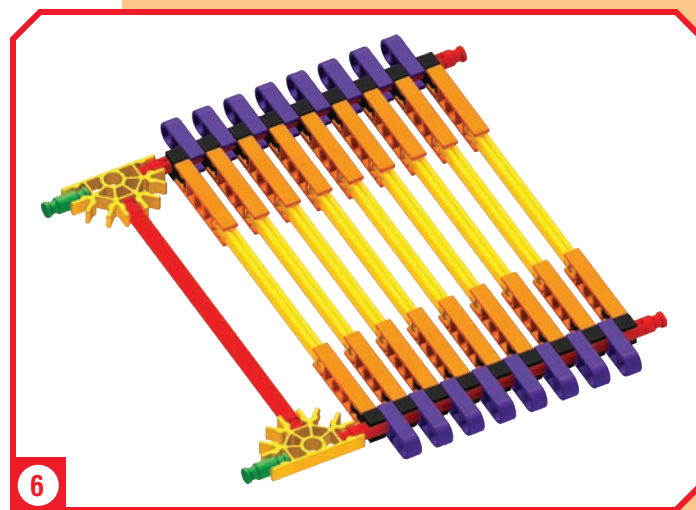
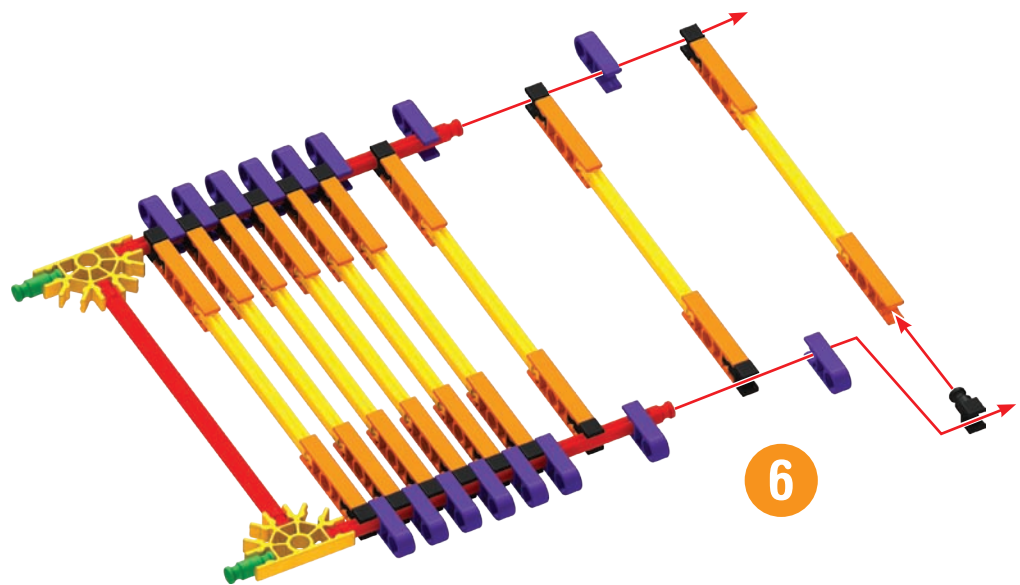

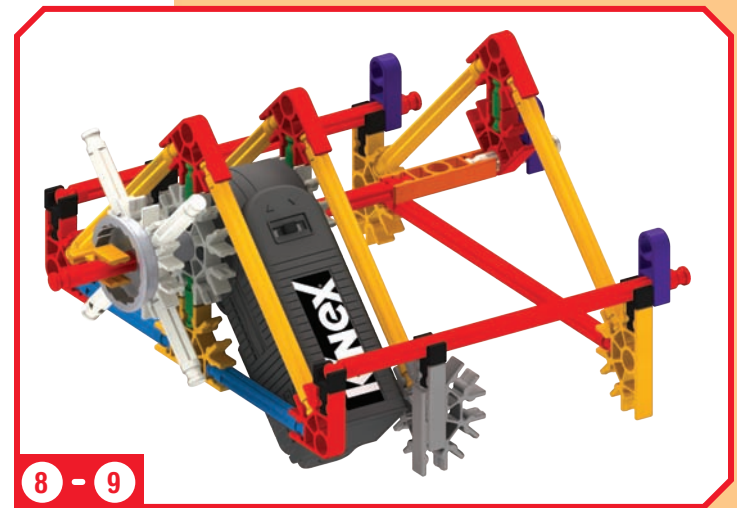
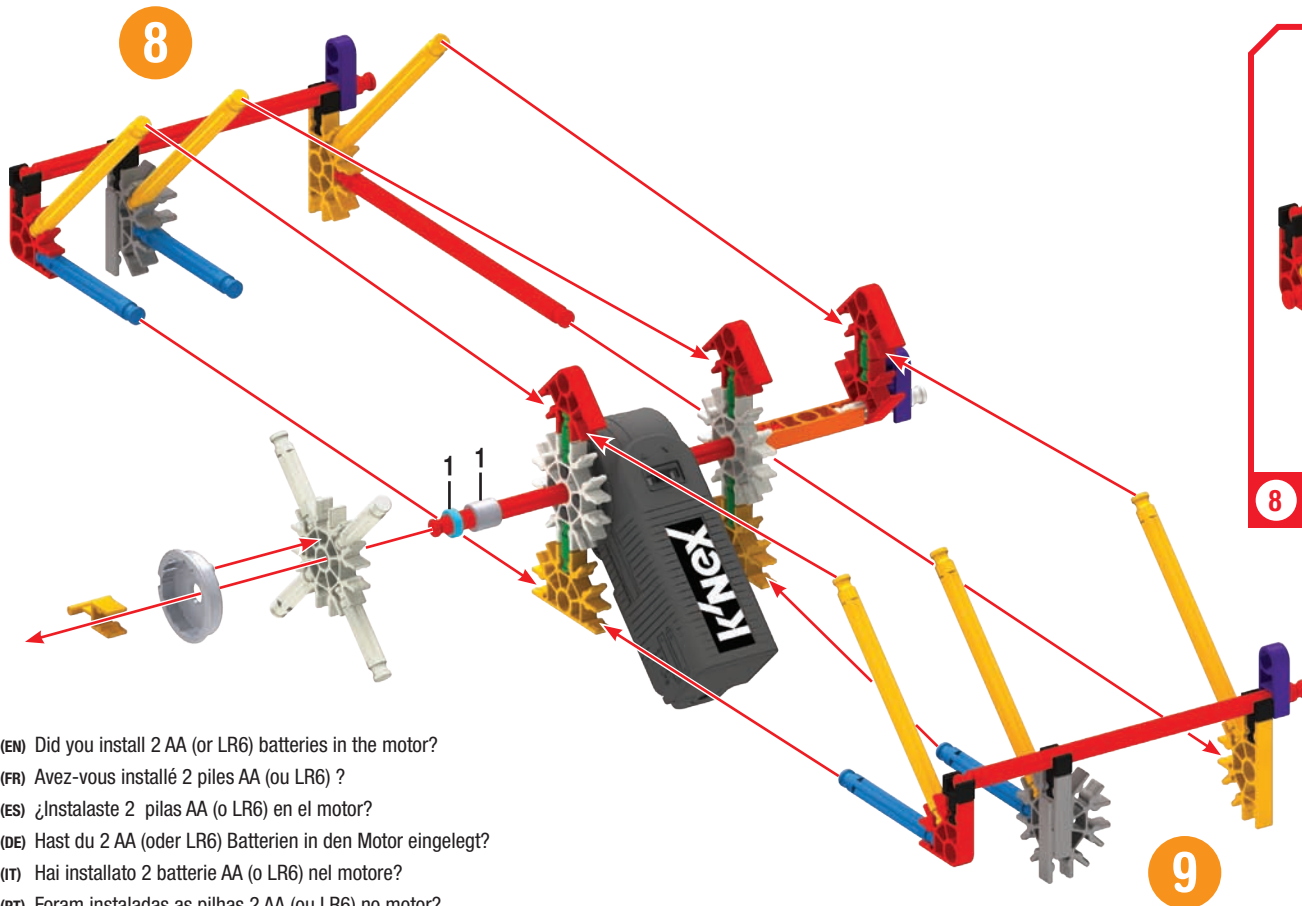

- (EN) Did you install 2 AA (or LR6) batteries in the motor?  
 (FR) Avez-vous installé 2 piles AA (ou LR6) ?  
 (ES) ¿Instalaste 2 pilas AA (o LR6) en el motor?  
 (DE) Hast du 2 AA (oder LR6) Batterien in den Motor eingelegt?  
 (IT) Hai installato 2 batterie AA (o LR6) nel motore?  
 (PT) Foram instaladas as pilhas 2 AA (ou LR6) no motor?  
 (NL) Heb je 2 AA (of LR6)-batterijen in de motor geplaatst?

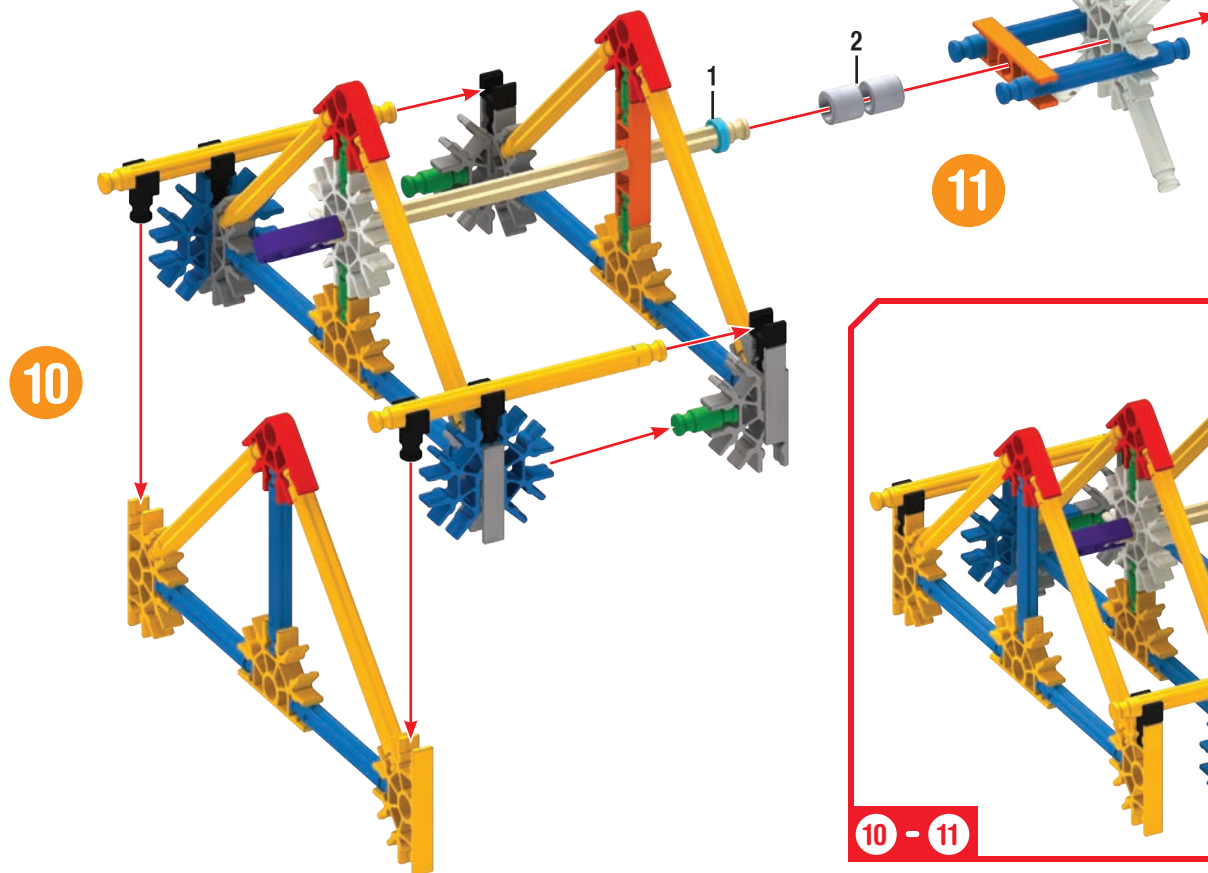

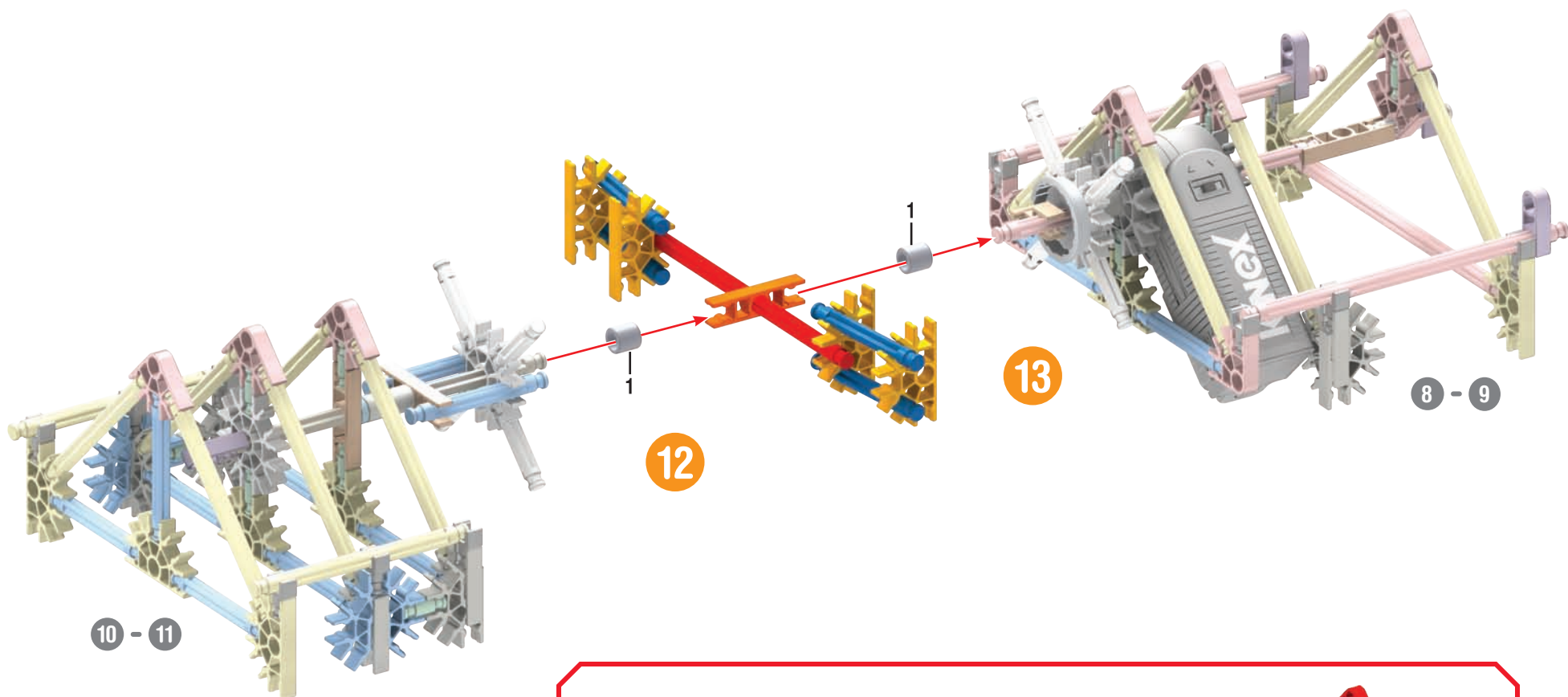



8 - 15

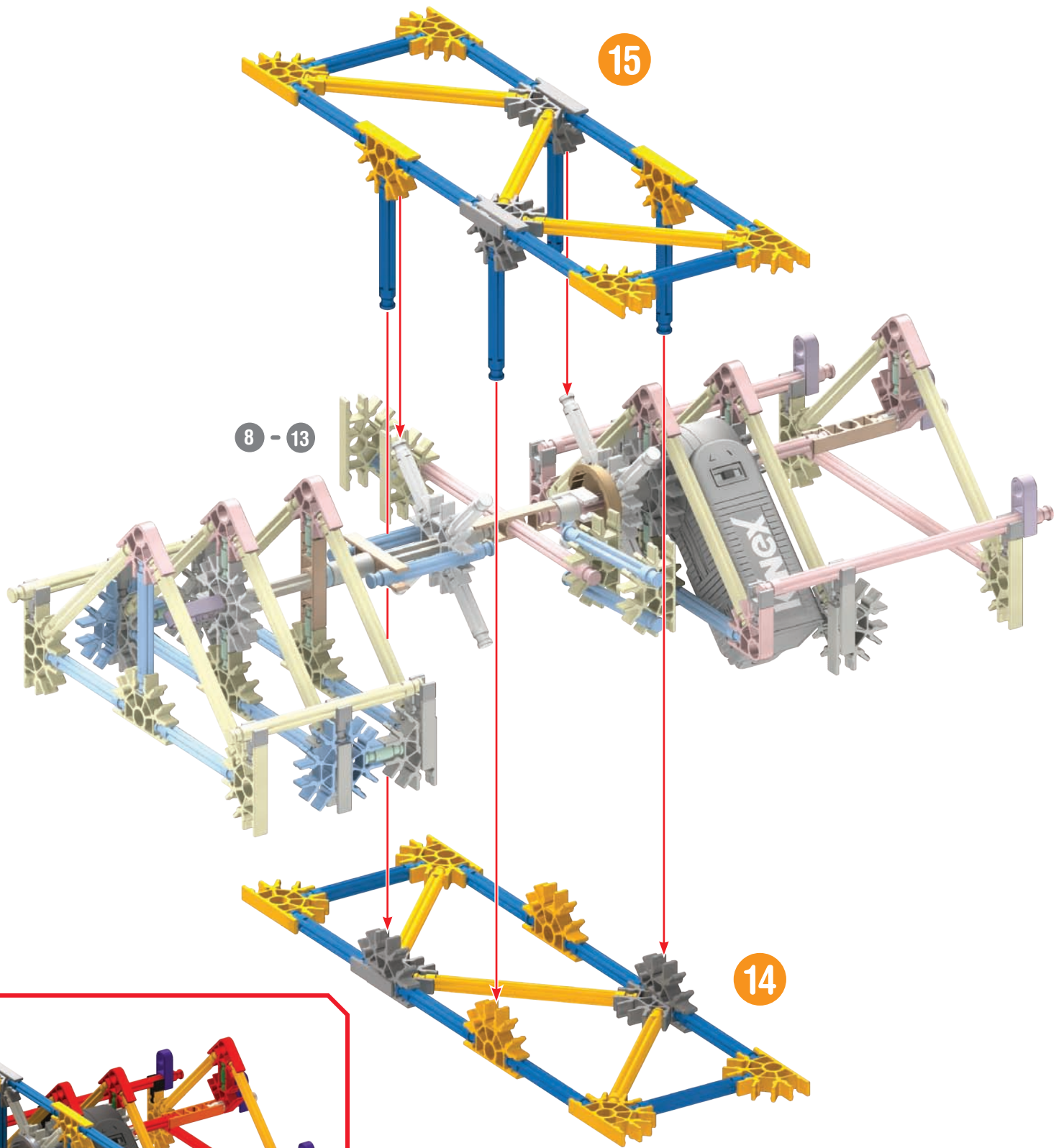

15

8 - 13

14

17

16

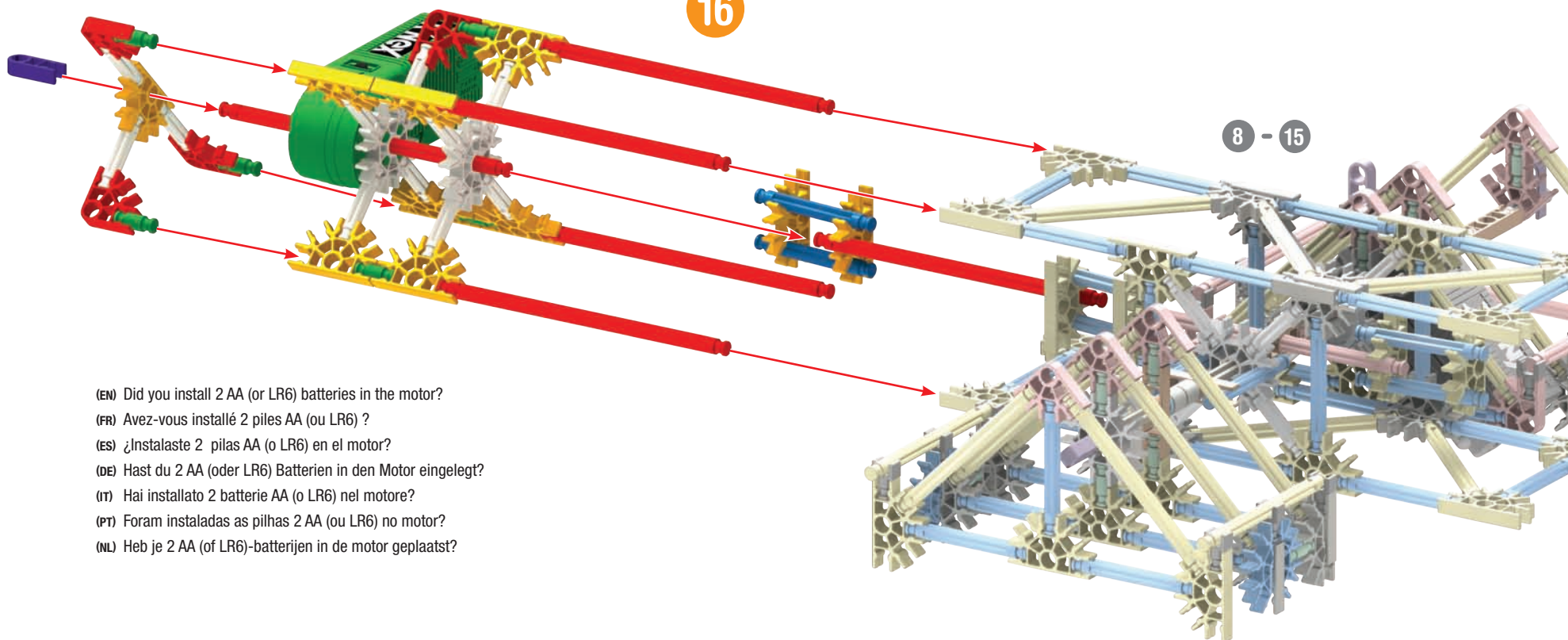

- (EN) Did you install 2 AA (or LR6) batteries in the motor?  
 (FR) Avez-vous installé 2 piles AA (ou LR6) ?  
 (ES) ¿Instalaste 2 pilas AA (o LR6) en el motor?  
 (DE) Hast du 2 AA (oder LR6) Batterien in den Motor eingelegt?  
 (IT) Hai installato 2 batterie AA (o LR6) nel motore?  
 (PT) Foram instaladas as pilhas 2 AA (ou LR6) no motor?  
 (NL) Heb je 2 AA (of LR6)-batterijen in de motor geplaatst?

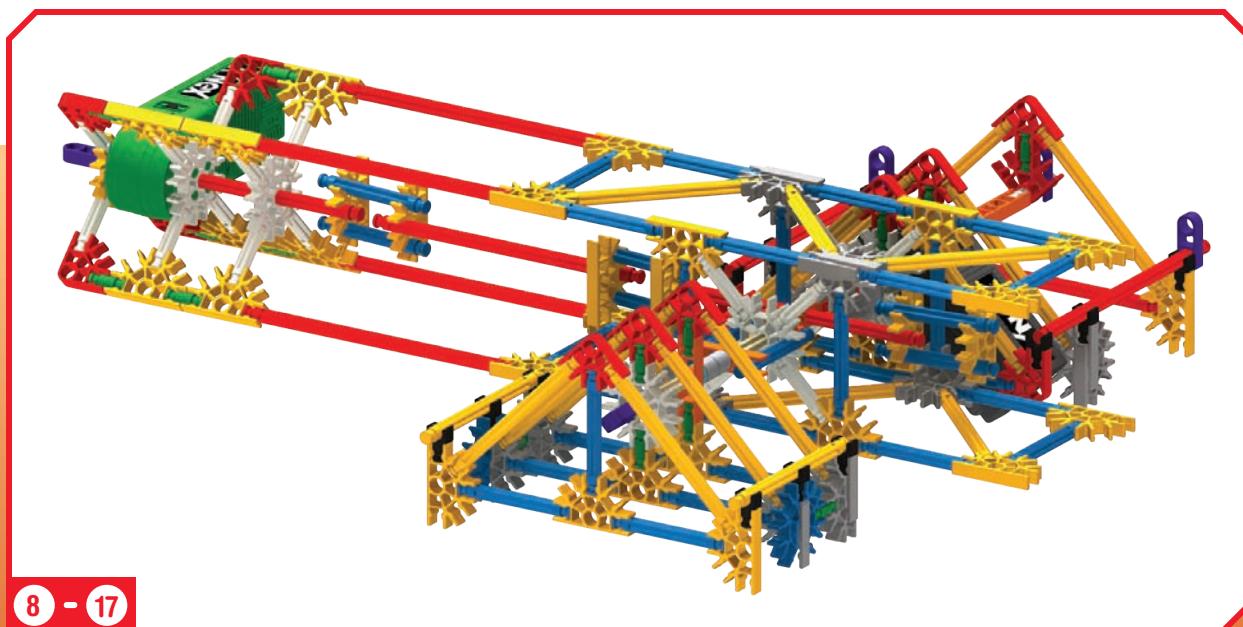

8 - 17

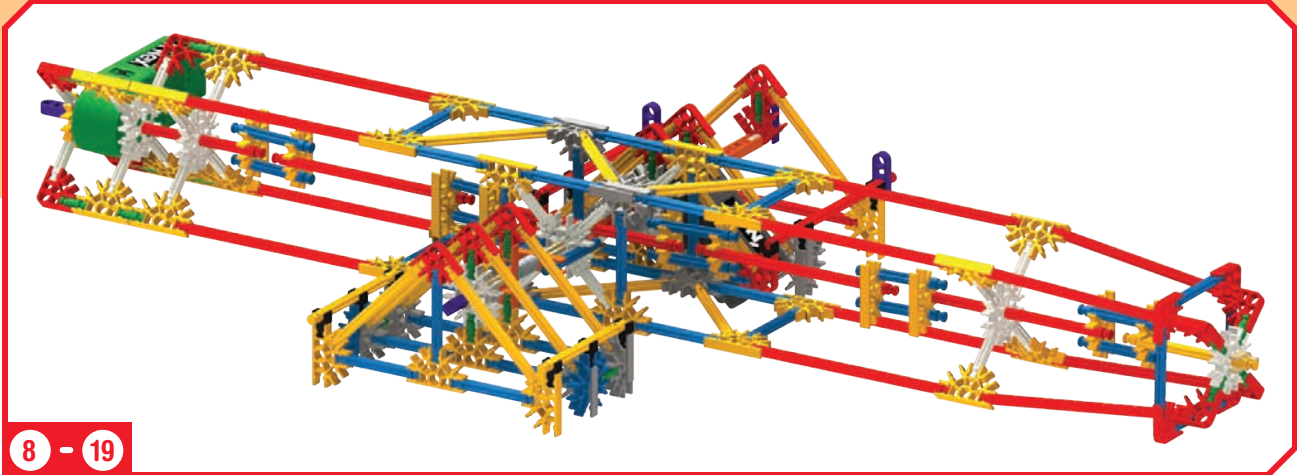

8 - 17

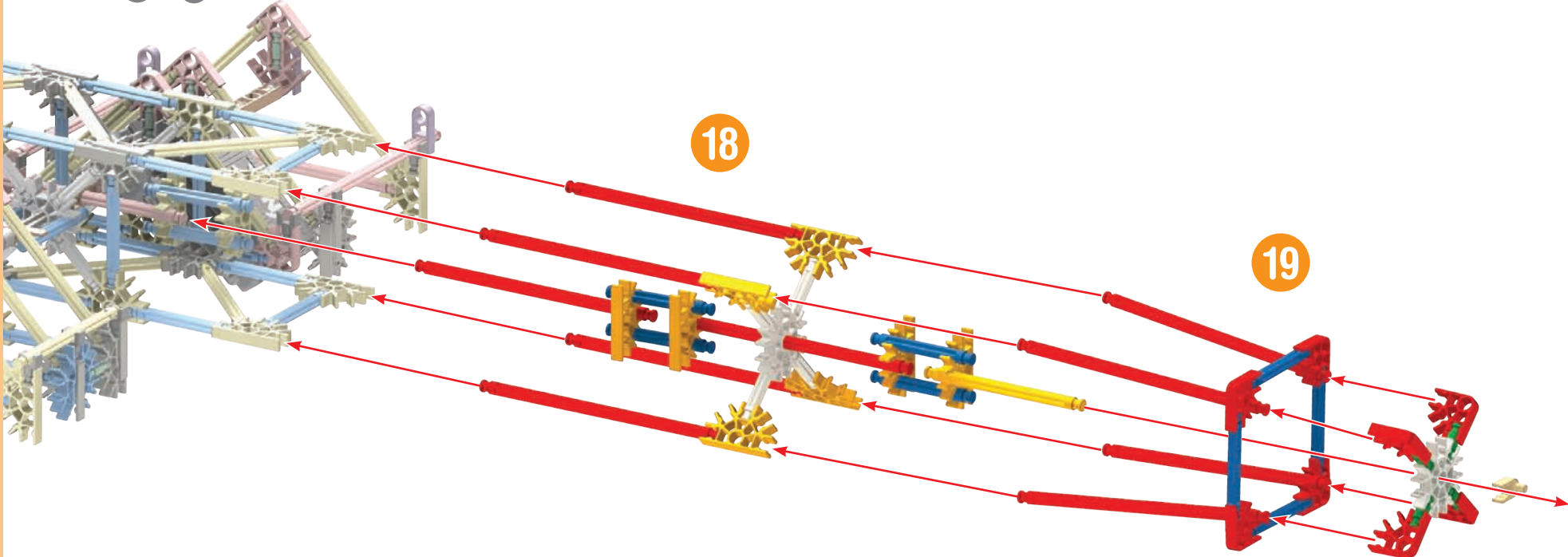

18

19

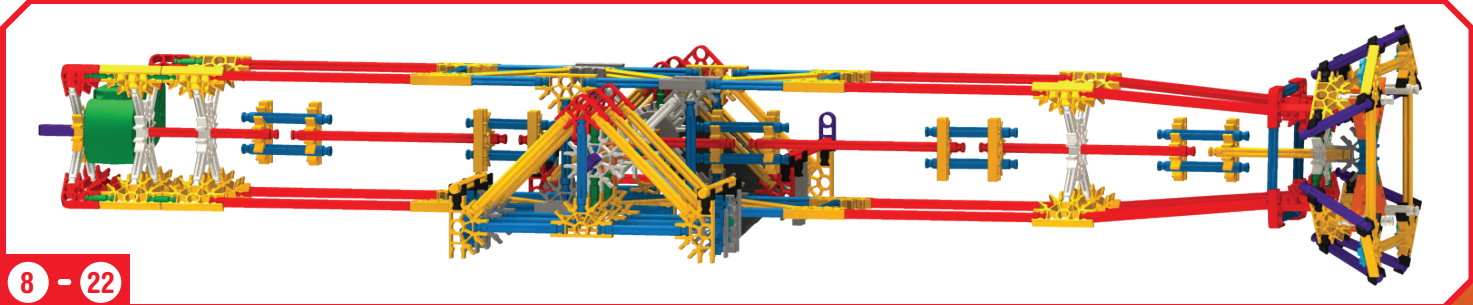
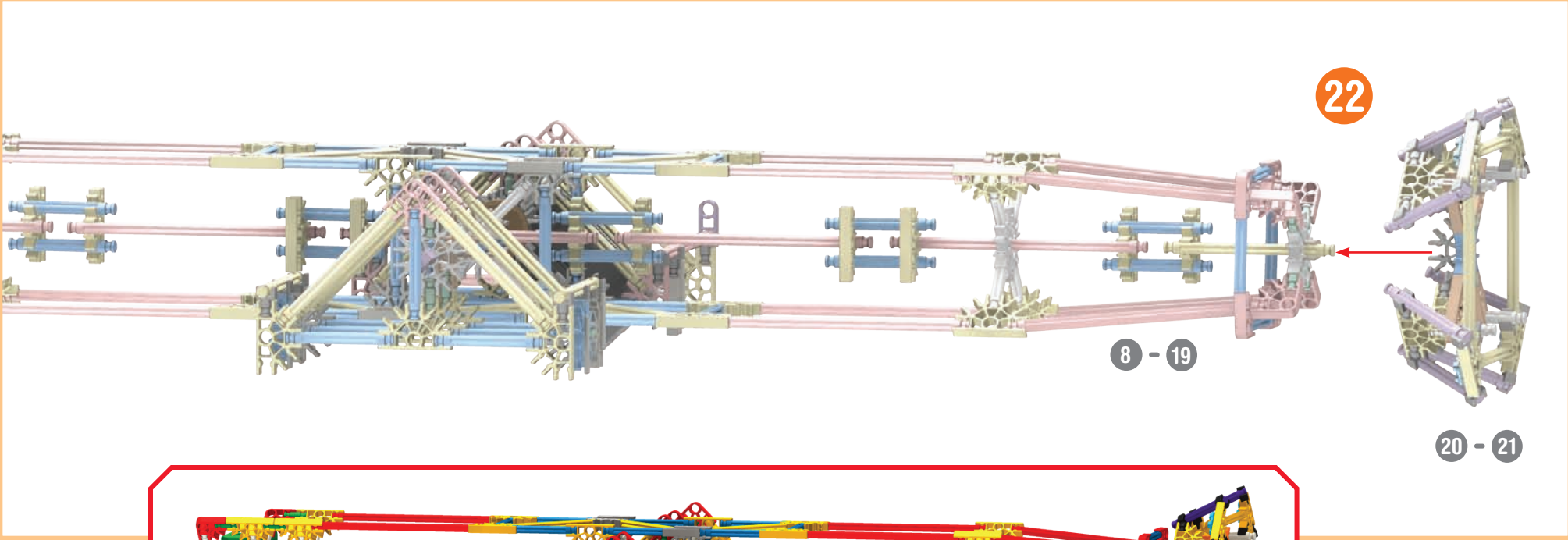
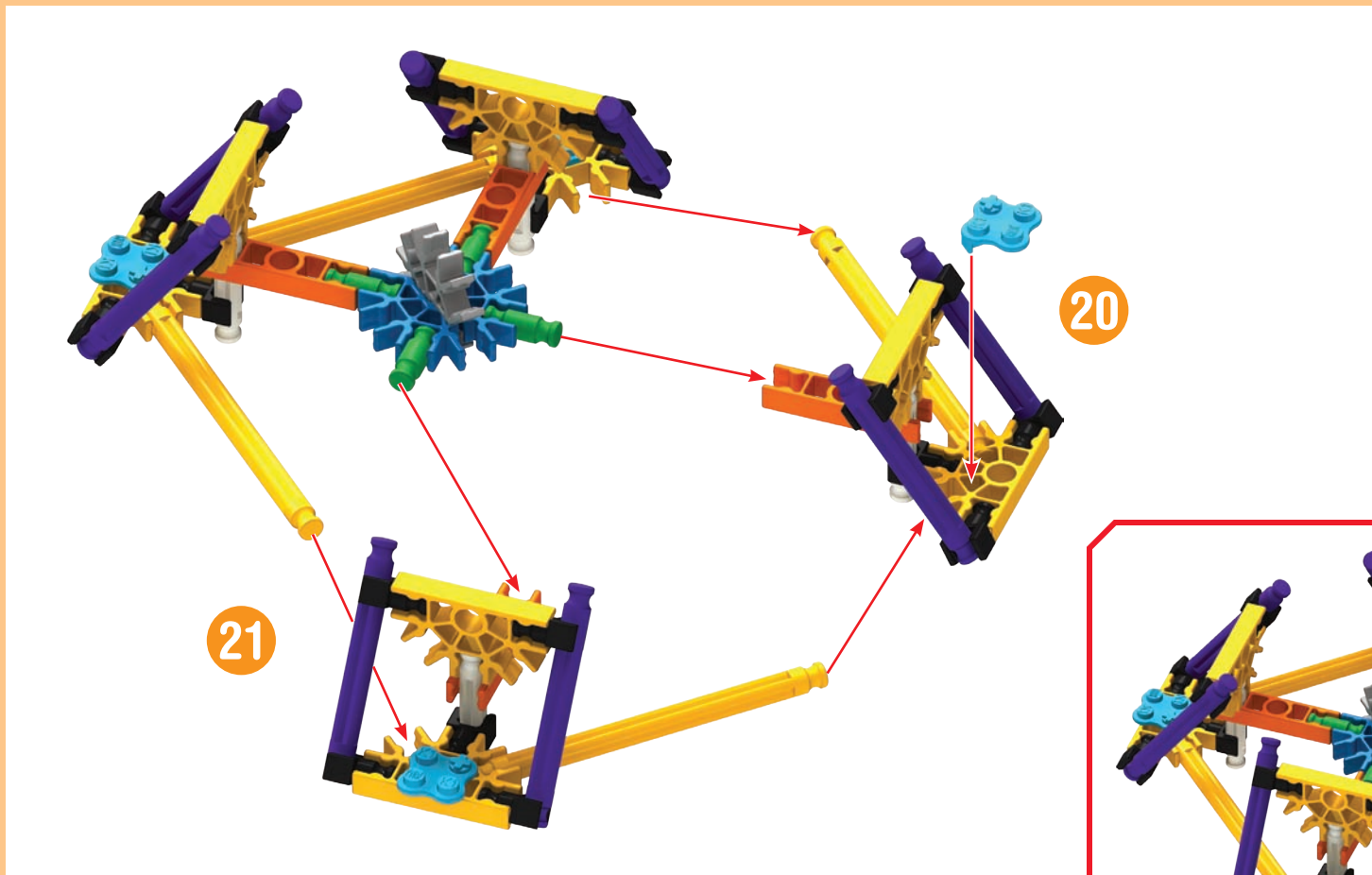

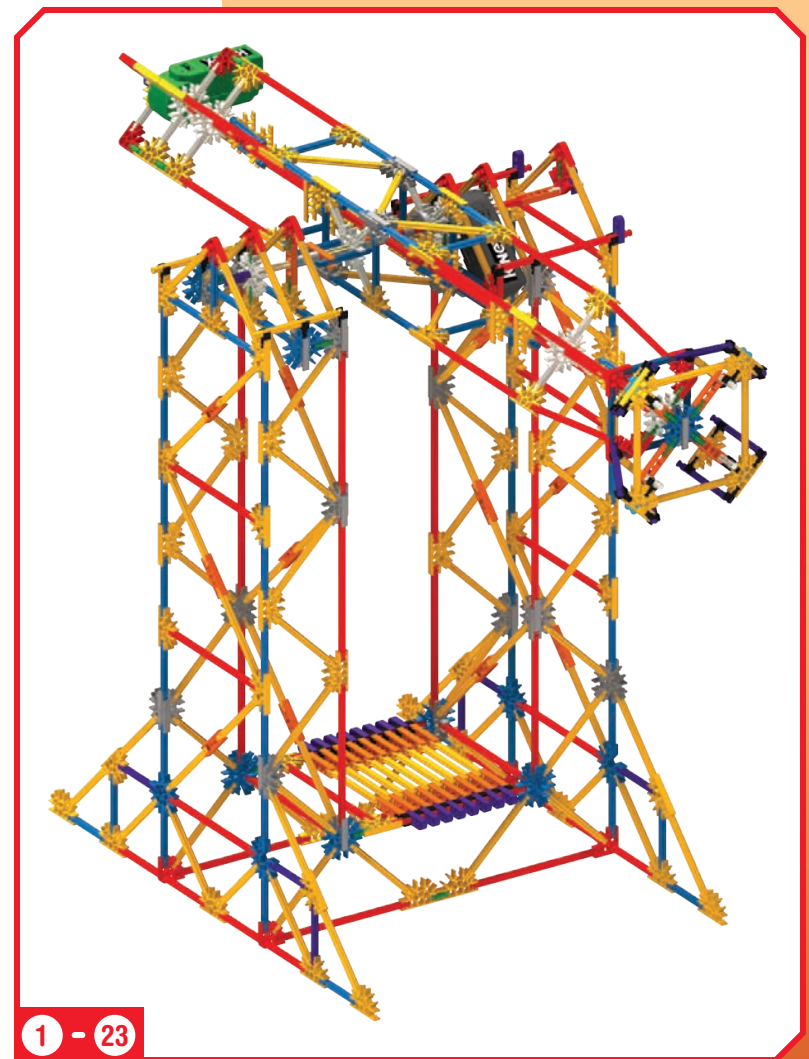
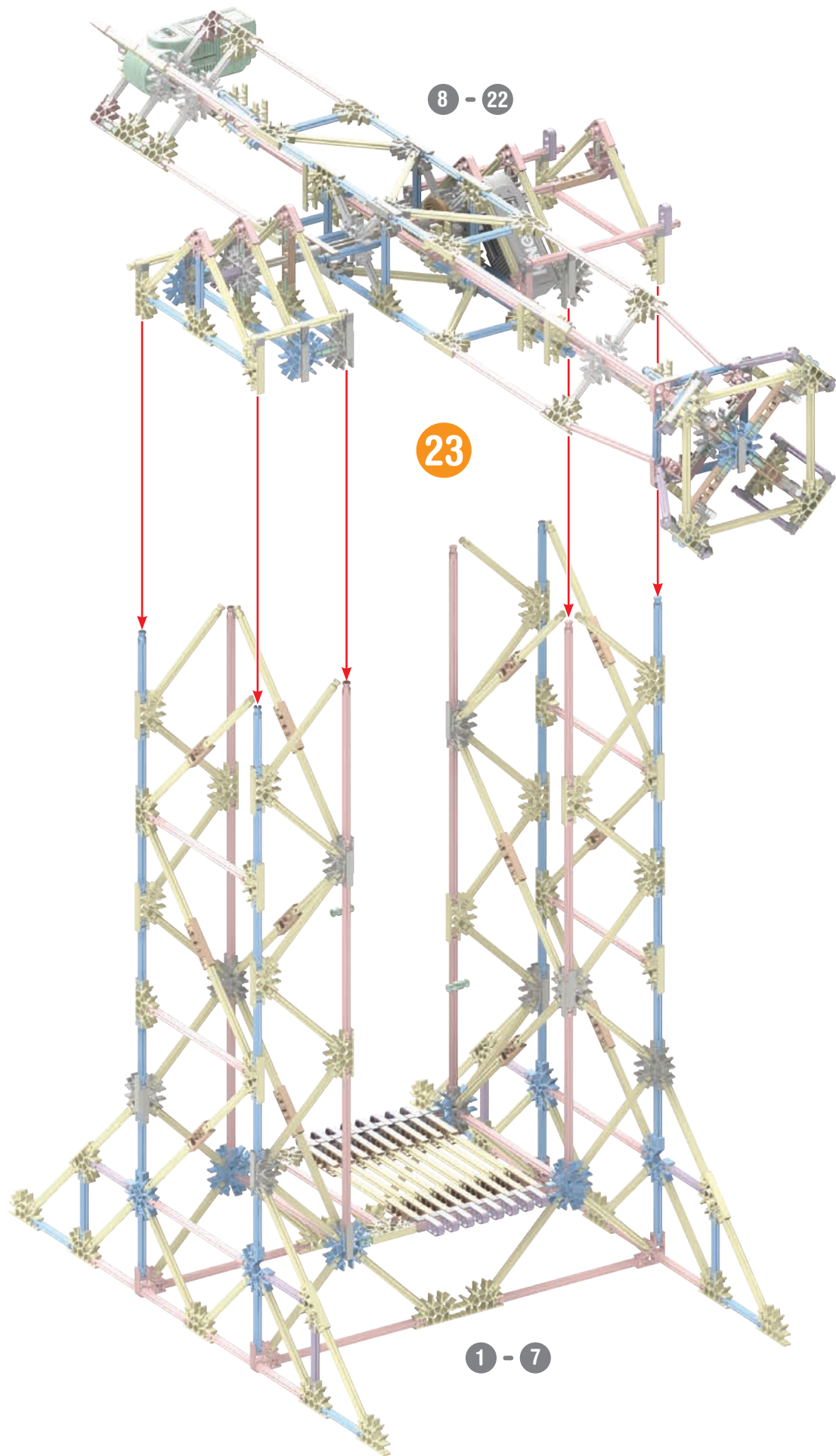



(Pagina 4)

## Istruzioni di base per costruire con K’NEX

Comincia a costruire

Per iniziare il modello, cerca il numero 1 e segui i numeri. Ogni pezzo ha una sua forma e un suo colore. Guarda la figura, trova i pezzi corrispondenti nel set e mettili insieme. Cerca di tenere il modello nella stessa direzione della figura e in tal modo sarà più semplice attaccare i pezzi nei posti giusti. I colori spenti ti dicono che questa sezione è già stata costruita. Dovrai collegare la nuova sezione al punto indicato dalla punta della freccia.

**Connettori**

È molto importante posizionare i connettori blu e argento in una specifica direzione. Presta molta attenzione alle istruzioni e posiziona i connettori orizzontalmente o verticalmente proprio come illustrato. Spingi con forza fino ad udire un clic.

**Spaziatori**

Ci sono punti nel tuo modello a cui dovrai aggiungere spaziatori blu e argento. Accertati si contarli attentamente.

**Elenco delle parti**

Prima di cominciare a costruire, accertati di confrontare le parti che sono nel tuo set con l’elenco delle parti qui. Se ne manca una chiamaci o scrivici usando le informazioni che sono nella retrocopertina. Noi siamo qui per aiutarti!

<b>EN</b>	<b>English</b>
<b>FR</b>	<b>Français</b>
<b>DE</b>	<b>Deutsch</b>
<b>ES</b>	<b>Español</b>
<b>IT</b>	<b>Italiano</b>
<b>PT</b>	<b>Português</b>
<b>RU</b>	<b>Русский</b>
<b>UK</b>	<b>Українська</b>
<b>PL</b>	<b>Polski</b>
<b>NL</b>	<b>Nederlands</b>
<b>SE</b>	<b>Svenska</b>
<b>SV</b>	<b>Svenska</b>
<b>TR</b>	<b>Türkçe</b>
<b>UA</b>	<b>Українська</b>
<b>CS</b>	<b>Česky</b>
<b>SK</b>	<b>Slovensky</b>
<b>SI</b>	<b>Slovenščina</b>
<b>HR</b>	<b>Hrvatski</b>
<b>RO</b>	<b>Română</b>
<b>LT</b>	<b>Lietuvių</b>
<b>LV</b>	<b>Latviešu</b>
<b>EL</b>	<b>Ελληνικά</b>
<b>HE</b>	<b>עברית</b>
<b>HI</b>	<b>हिन्दी</b>
<b>JA</b>	<b>日本語</b>
<b>KO</b>	<b>한국어</b>
<b>TH</b>	<b>ไทย</b>
<b>VI</b>	<b>Việt Nam</b>
<b>PH</b>	<b>Tagalog</b>
<b>BN</b>	<b>বাংলা</b>
<b>IN</b>	<b>இந்திய</b>
<b>MY</b>	<b>Malaysia</b>
<b>SG</b>	<b>Singapore</b>
<b>BR</b>	<b>Português do Brasil</b>
<b>PT</b>	<b>Português de Portugal</b>
<b>RU</b>	<b>Русский</b>
<b>UK</b>	<b>Українська</b>
<b>PL</b>	<b>Polski</b>
<b>NL</b>	<b>Nederlands</b>
<b>SE</b>	<b>Svenska</b>
<b>SV</b>	<b>Svenska</b>
<b>TR</b>	<b>Türkçe</b>
<b>UA</b>	<b>Українська</b>
<b>CS</b>	<b>Česky</b>
<b>SK</b>	<b>Slovensky</b>
<b>SI</b>	<b>Slovenščina</b>
<b>HR</b>	<b>Hrvatski</b>
<b>RO</b>	<b>Română</b>
<b>LT</b>	<b>Lietuvių</b>
<b>LV</b>	<b>Latviešu</b>
<b>EL</b>	<b>Ελληνικά</b>
<b>HE</b>	<b>עברית</b>
<b>HI</b>	<b>हिन्दी</b>
<b>JA</b>	<b>日本語</b>
<b>KO</b>	<b>한국어</b>
<b>TH</b>	<b>ไทย</b>
<b>VI</b>	<b>Việt Nam</b>
<b>PH</b>	<b>Tagalog</b>
<b>BN</b>	<b>বাংলা</b>
<b>IN</b>	<b>இந்திய</b>
<b>MY</b>	<b>Malaysia</b>
<b>SG</b>	<b>Singapore</b>
<b>BR</b>	<b>Português do Brasil</b>
<b>PT</b>	<b>Português de Portugal</b>
<b>RU</b>	<b>Русский</b>
<b>UK</b>	<b>Українська</b>
<b>PL</b>	<b>Polski</b>
<b>NL</b>	<b>Nederlands</b>
<b>SE</b>	<b>Svenska</b>
<b>SV</b>	<b>Svenska</b>
<b>TR</b>	<b>Türkçe</b>
<b>UA</b>	<b>Українська</b>
<b>CS</b>	<b>Česky</b>
<b>SK</b>	<b>Slovensky</b>
<b>SI</b>	<b>Slovenščina</b>
<b>HR</b>	<b>Hrvatski</b>
<b>RO</b>	<b>Română</b>
<b>LT</b>	<b>Lietuvių</b>
<b>LV</b>	<b>Latviešu</b>
<b>EL</b>	<b>Ελληνικά</b>
<b>HE</b>	<b>עברית</b>
<b>HI</b>	<b>हिन्दी</b>
<b>JA</b>	<b>日本語</b>
<b>KO</b>	<b>한국어</b>
<b>TH</b>	<b>ไทย</b>
<b>VI</b>	<b>Việt Nam</b>
<b>PH</b>	<b>Tagalog</b>
<b>BN</b>	<b>বাংলা</b>
<b>IN</b>	<b>இந்திய</b>
<b>MY</b>	<b>Malaysia</b>
<b>SG</b>	<b>Singapore</b>
<b>BR</b>	<b>Português do Brasil</b>
<b>PT</b>	<b>Português de Portugal</b>
<b>RU</b>	<b>Русский</b>
<b>UK</b>	<b>Українська</b>
<b>PL</b>	<b>Polski</b>
<b>NL</b>	<b>Nederlands</b>
<b>SE</b>	<b>Svenska</b>
<b>SV</b>	<b>Svenska</b>
<b>TR</b>	<b>Türkçe</b>
<b>UA</b>	<b>Українська</b>
<b>CS</b>	<b>Česky</b>
<b>SK</b>	<b>Slovensky</b>
<b>SI</b>	<b>Slovenščina</b>
<b>HR</b>	<b>Hrvatski</b>
<b>RO</b>	<b>Română</b>
<b>LT</b>	<b>Lietuvių</b>
<b>LV</b>	<b>Latviešu</b>
<b>EL</b>	<b>Ελληνικά</b>
<b>HE</b>	<b>עברית</b>
<b>HI</b>	<b>हिन्दी</b>
<b>JA</b>	<b>日本語</b>
<b>KO</b>	<b>한국어</b>
<b>TH</b>	<b>ไทย</b>
<b>VI</b>	<b>Việt Nam</b>
<b>PH</b>	<b>Tagalog</b>
<b>BN</b>	<b>বাংলা</b>
<b>IN</b>	<b>இந்திய</b>
<b>MY</b>	<b>Malaysia</b>
<b>SG</b>	<b>Singapore</b>
<b>BR</b>	<b>Português do Brasil</b>
<b>PT</b>	<b>Português de Portugal</b>
<b>RU</b>	<b>Русский</b>
<b>UK</b>	<b>Українська</b>
<b>PL</b>	<b>Polski</b>
<b>NL</b>	<b>Nederlands</b>
<b>SE</b>	<b>Svenska</b>
<b>SV</b>	<b>Svenska</b>
<b>TR</b>	<b>Türkçe</b>
<b>UA</b>	<b>Українська</b>
<b>CS</b>	<b>Česky</b>
<b>SK</b>	<b>Slovensky</b>
<b>SI</b>	<b>Slovenščina</b>
<b>HR</b>	<b>Hrvatski</b>
<b>RO</b>	<b>Română</b>
<b>LT</b>	<b>Lietuvių</b>
<b>LV</b>	<b>Latviešu</b>
<b>EL</b>	<b>Ελληνικά</b>
<b>HE</b>	<b>עברית</b>
<b>HI</b>	<b>हिन्दी</b>
<b>JA</b>	<b>日本語</b>
<b>KO</b>	<b>한국어</b>
<b>TH</b>	<b>ไทย</b>
<b>VI</b>	<b>Việt Nam</b>
<b>PH</b>	<b>Tagalog</b>
<b>BN</b>	<b>বাংলা</b>
<b>IN</b>	<b>இந்திய</b>
<b>MY</b>	<b>Malaysia</b>
<b>SG</b>	<b>Singapore</b>
<b>BR</b>	<b>Português do Brasil</b>
<b>PT</b>	<b>Português de Portugal</b>
<b>RU</b>	<b>Русский</b>
<b>UK</b>	<b>Українська</b>
<b>PL</b>	<b>Polski</b>
<b>NL</b>	<b>Nederlands</b>
<b>SE</b>	<b>Svenska</b>
<b>SV</b>	<b>Svenska</b>
<b>TR</b>	<b>Türkçe</b>
<b>UA</b>	<b>Українська</b>
<b>CS</b>	<b>Česky</b>
<b>SK</b>	<b>Slovensky</b>
<b>SI</b>	<b>Slovenščina</b>
<b>HR</b>	<b>Hrvatski</b>
<b>RO</b>	<b>Română</b>
<b>LT</b>	<b>Lietuvių</b>
<b>LV</b>	<b>Latviešu</b>
<b>EL</b>	<b>Ελληνικά</b>
<b>HE</b>	<b>עברית</b>
<b>HI</b>	<b>हिन्दी</b>
<b>JA</b>	<b>日本語</b>
<b>KO</b>	<b>한국어</b>
<b>TH</b>	<b>ไทย</b>
<b>VI</b>	<b>Việt Nam</b>
<b>PH</b>	<b>Tagalog</b>
<b>BN</b>	<b>বাংলা</b>
<b>IN</b>	<b>இந்திய</b>
<b>MY</b>	<b>Malaysia</b>
<b>SG</b>	<b>Singapore</b>
<b>BR</b>	<b>Português do Brasil</b>
<b>PT</b>	<b>Português de Portugal</b>
<b>RU</b>	<b>Русский</b>
<b>UK</b>	<b>Українська</b>
<b>PL</b>	<b>Polski</b>
<b>NL</b>	<b>Nederlands</b>
<b>SE</b>	<b>Svenska</b>
<b>SV</b>	<b>Svenska</b>
<b>TR</b>	<b>Türkçe</b>
<b>UA</b>	<b>Українська</b>
<b>CS</b>	<b>Česky</b>
<b>SK</b>	<b>Slovensky</b>
<b>SI</b>	<b>Slovenščina</b>
<b>HR</b>	<b>Hrvatski</b>
<b>RO</b>	<b>Română</b>
<b>LT</b>	<b>Lietuvių</b>
<b>LV</b>	<b>Latviešu</b>
<b>EL</b>	<b>Ελληνικά</b>
<b>HE</b>	<b>עברית</b>
<b>HI</b>	<b>हिन्दी</b>
<b>JA</b>	<b>日本語</b>
<b>KO</b>	<b>한국어</b>
<b>TH</b>	<b>ไทย</b>
<b>VI</b>	<b>Việt Nam</b>
<b>PH</b>	<b>Tagalog</b>
<b>BN</b>	<b>বাংলা</b>
<b>IN</b>	<b>இந்திய</b>
<b>MY</b>	<b>Malaysia</b>
<b>SG</b>	<b>Singapore</b>
<b>BR</b>	<b>Português do Brasil</b>
<b>PT</b>	<b>Português de Portugal</b>
<b>RU</b>	<b>Русский</b>
<b>UK</b>	<b>Українська</b>
<b>PL</b>	<b>Polski</b>
<b>NL</b>	<b>Nederlands</b>
<b>SE</b>	<b>Svenska</b>
<b>SV</b>	<b>Svenska</b>
<b>TR</b>	<b>Türkçe</b>
<b>UA</b>	<b>Українська</b>
<b>CS</b>	<b>Česky</b>
<b>SK</b>	<b>Slovensky</b>
<b>SI</b>	<b>Slovenščina</b>
<b>HR</b>	<b>Hrvatski</b>
<b>RO</b>	<b>Română</b>
<b>LT</b>	<b>Lietuvių</b>
<b>LV</b>	<b>Latviešu</b>
<b>EL</b>	<b>Ελληνικά</b>
<b>HE</b>	<b>עברית</b>
<b>HI</b>	<b>हिन्दी</b>
<b>JA</b>	<b>日本語</b>
<b>KO</b>	<b>한국어</b>
<b>TH</b>	<b>ไทย</b>
<b>VI</b>	<b>Việt Nam</b>
<b>PH</b>	<b>Tagalog</b>
<b>BN</b>	<b>বাংলা</b>
<b>IN</b>	<b>இந்திய</b>
<b>MY</b>	<b>Malaysia</b>
<b>SG</b>	<b>Singapore</b>
<b>BR</b>	<b>Português do Brasil</b>
<b>PT</b>	<b>Português de Portugal</b>
<b>RU</b>	<b>Русский</b>
<b>UK</b>	<b>Українська</b>
<b>PL</b>	<b>Polski</b>
<b>NL</b>	<b>Nederlands</b>
<b>SE</b>	<b>Svenska</b>
<b>SV</b>	<b>Svenska</b>
<b>TR</b>	<b>Türkçe</b>
<b>UA</b>	<b>Українська</b>
<b>CS</b>	<b>Česky</b>
<b>SK</b>	<b>Slovensky</b>
<b>SI</b>	<b>Slovenščina</b>
<b>HR</b>	<b>Hrvatski</b>
<b>RO</b>	<b>Română</b>
<b>LT</b>	<b>Lietuvių</b>
<b>LV</b>	<b>Latviešu</b>
<b>EL</b>	<b>Ελληνικά</b>
<b>HE</b>	<b>עברית</b>
<b>HI</b>	<b>हिन्दी</b>
<b>JA</b>	<b>日本語</b>
<b>KO</b>	<b>한국어</b>
<b>TH</b>	<b>ไทย</b>
<b>VI</b>	<b>Việt Nam</b>
<b>PH</b>	<b>Tagalog</b>
<b>BN</b>	<b>বাংলা</b>
<b>IN</b>	<b>இந்திய</b>
<b>MY</b>	<b>Malaysia</b>
<b>SG</b>	<b>Singapore</b>
<b>BR</b>	<b>Português do Brasil</b>
<b>PT</b>	<b>Português de Portugal</b>
<b>RU</b>	<b>Русский</b>
<b>UK</b>	<b>Українська</b>
<b>PL</b>	<b>Polski</b>
<b>NL</b>	<b>Nederlands</b>
<b>SE</b>	<b>Svenska</b>
<b>SV</b>	<b>Svenska</b>
<b>TR</b>	<b>Türkçe</b>
<b>UA</b>	<b>Українська</b>
<b>CS</b>	<b>Česky</b>
<b>SK</b>	<b>Slovensky</b>
<b>SI</b>	<b>Slovenščina</b>
<b>HR</b>	<b>Hrvatski</b>
<b>RO</b>	<b>Română</b>
<b>LT</b>	<b>Lietuvių</b>
<b>LV</b>	<b>Latviešu</b>
<b>EL</b>	<b>Ελληνικά</b>
<b>HE</b>	<b>עברית</b>
<b>HI</b>	<b>हिन्दी</b>
<b>JA</b>	<b>日本語</b>
<b>KO</b>	<b>한국어</b>
<b>TH</b>	<b>ไทย</b>
<b>VI</b>	<b>Việt Nam</b>
<b>PH</b>	<b>Tagalog</b>
<b>BN</b>	<b>বাংলা</b>
<b>IN</b>	<b>இந்திய</b>
<b>MY</b>	<b>Malaysia</b>
<b>SG</b>	<b>Singapore</b>
<b>BR</b>	<b>Português do Brasil</b>
<b>PT</b>	<b>Português de Portugal</b>
<b>RU</b>	<b>Русский</b>
<b>UK</b>	<b>Українська</b>
<b>PL</b>	<b>Polski</b>
<b>NL</b>	<b>Nederlands</b>
<b>SE</b>	<b>Svenska</b>
<b>SV</b>	<b>Svenska</b>
<b>TR</b>	<b>Türkçe</b>
<b>UA</b>	<b>Українська</b>
<b>CS</b>	<b>Česky</b>
<b>SK</b>	<b>Slovensky</b>
<b>SI</b>	<b>Slovenščina</b>
<b>HR</b>	<b>Hrvatski</b>
<b>RO</b>	<b>Română</b>
<b>LT</b>	<b>Lietuvių</b>
<b>LV</b>	<b>Latviešu</b>
<b>EL</b>	<b>Ελληνικά</b>
<b>HE</b>	<b>עברית</b>
<b>HI</b>	<b>हिन्दी</b>
<b>JA</b>	<b>日本語</b>
<b>KO</b>	<b>한국어</b>
<b>TH</b>	<b>ไทย</b>
<b>VI</b>	<b>Việt Nam</b>
<b>PH</b>	<b>Tagalog</b>
<b>BN</b>	<b>বাংলা</b>
<b>IN</b>	<b>இந்திய</b>
<b>MY</b>	<b>Malaysia</b>
<b>SG</b>	<b>Singapore</b>
<b>BR</b>	<b>Português do Brasil</b>
<b>PT</b>	<b>Português de Portugal</b>
<b>RU</b>	<b>Русский</b>
<b>UK</b>	<b>Українська</b>
<b>PL</b>	<b>Polski</b>
<b>NL</b>	<b>Nederlands</b>
<b>SE</b>	<b>Svenska</b>
<b>SV</b>	<b>Svenska</b>
<b>TR</b>	<b>Türkçe</b>
<b>UA</b>	<b>Українська</b>
<b>CS</b>	<b>Česky</b>
<b>SK</b>	<b>Slovensky</b>
<b>SI</b>	<b>Slovenščina</b>
<b>HR</b>	<b>Hrvatski</b>
<b>RO</b>	<b>Română</b>
<b>LT</b>	<b>Lietuvių</b>
<b>LV</b>	<b>Latviešu</b>
<b>EL</b>	<b>Ελληνικά</b>
<b>HE</b>	<b>עברית</b>
<b>HI</b>	<b>हिन्दी</b>
<b>JA</b>	<b>日本語</b>
<b>KO</b>	<b>한국어</b>
<b>TH</b>	<b>ไทย</b>
<b>VI</b>	<b>Việt Nam</b>
<b>PH</b>	<b>Tagalog</b>
<b>BN</b>	<b>বাংলা</b>
<b>IN</b>	<b>இந்திய</b>
<b>MY</b>	<b>Malaysia</b>
<b>SG</b>	<b>Singapore</b>
<b>BR</b>	<b>Português do Brasil</b>
<b>PT</b>	<b>Português de Portugal</b>
<b>RU</b>	<b>Русский</b>
<b>UK</b>	<b>Українська</b>
<b>PL</b>	<b>Polski</b>
<b>NL</b>	<b>Nederlands</b>
<b>SE</b>	<b>Svenska</b>
<b>SV</b>	<b>Svenska</b>
<b>TR</b>	<b>Türkçe</b>
<b>UA</b>	<b>Українська</b>
<b>CS</b>	<b>Česky</b>
<b>SK</b>	<b>Slovensky</b>
<b>SI</b>	<b>Slovenščina</b>
<b>HR</b>	<b>Hrvatski</b>
<b>RO</b>	<b>Română</b>
<b>LT</b>	<b>Lietuvių</b>
<b>LV</b>	<b>Latviešu</b>
<b>EL</b>	<b>Ελληνικά</b>
<b>HE</b>	<b>עברית</b>
<b>HI</b>	<b>हिन्दी</b>
<b>JA</b>	<b>日本語</b>
<b>KO</b>	<b>한국어</b>
<b>TH</b>	<b>ไทย</b>
<b>VI</b>	<b>Việt Nam</b>
<b>PH</b>	<b>Tagalog</b>
<b>BN</b>	<b>বাংলা</b>
<b>IN</b>	<b>இந்திய</b>
<b>MY</b>	<b>Malaysia</b>
<b>SG</b>	<b>Singapore</b>
<b>BR</b>	<b>Português do Brasil</b>
<b>PT</b>	<b>Português de Portugal</b>
<b>RU</b>	<b>Русский</b>
<b>UK</b>	<b>Українська</b>
<b>PL</b>	<b>Polski</b>
<b>NL</b>	<b>Nederlands</b>
<b>SE</b>	<b>Svenska</b>
<b>SV</b>	<b>Svenska</b>
<b>TR</b>	<b>Türkçe</b>
<b>UA</b>	<b>Українська</b>
<b>CS</b>	<b>Česky</b>
<b>SK</b>	<b>Slovensky</b>
<b>SI</b>	<b>Slovenščina</b>
<b>HR</b>	<b>Hrvatski</b>
<b>RO</b>	<b>Română</b>
<b>LT</b>	<b>Lietuvių</b>
<b>LV</b>	<b>Latviešu</b>
<b>EL</b>	<b>Ελληνικά</b>
<b>HE</b>	<b>עברית</b>
<b>HI</b>	<b>हिन्दी</b>
<b>JA</b>	<b>日本語</b>
<b>KO</b>	<b>한국어</b>
<b>TH</b>	<b>ไทย</b>
<b>VI</b>	<b>Việt Nam</b>
<b>PH</b>	<b>Tagalog</b>
<b>BN</b>	<b>বাংলা</b>
<b>IN</b>	<b>இந்திய</b>
<b>MY</b>	<b>Malaysia</b>
<b>SG</b>	<b>Singapore</b>
<b>BR</b>	

# KNEX.COM

**2-IN-1  
FERRIS WHEEL  
BUILDING SET**

**2-EN-1  
LA GRANDE ROUE  
JEU DE CONSTRUCTION**

America's Building Toy  
Jouet de Construction d'Amérique  
Jugete de Construcción de América  
Amerikas Bauspielzeug

Gioco di costruzione dell'America  
Brinquedo de construção da América  
Het bouwspelgoed van Amerika

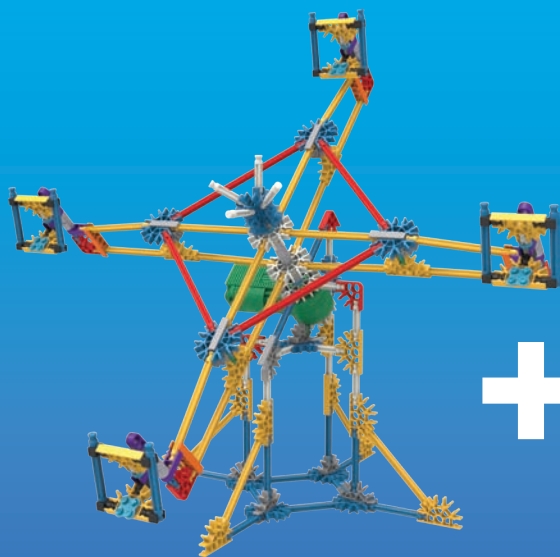

+



=

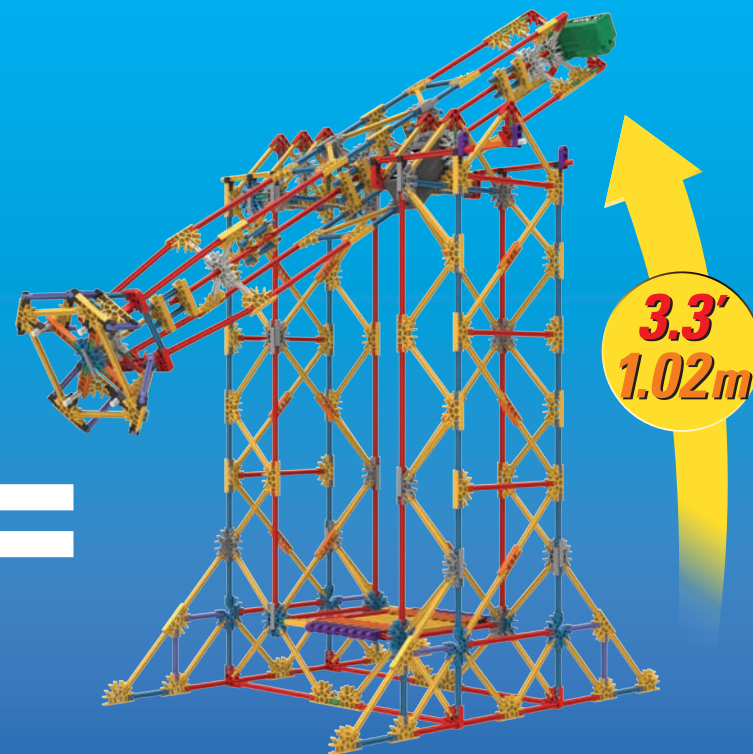

**SPIN RIDE  
TOUR DE TOURNOYER**

**FERRIS WHEEL  
LA GRANDE ROUE**

**TUMBLING TORNADO  
TORNADO EN TOMBANT**

Sold separately.  
Vendus séparément.  
Se venden por separado.  
Separat erhältlich.  
Venduti separatamente.  
Vendidos separadamente.  
Afzonderlijk verkocht.



\* Moteurs

[knex.com/knexpert](http://knex.com/knexpert)

[facebook.com/buildknex](https://facebook.com/buildknex)

(EN) K'NEX, Building Worlds Kids Love and America's Building Toy are registered trademarks of K'NEX Limited Partnership Group.  
(FR) K'NEX, Building Worlds Kids Love et America's Building Toy sont des marques déposées de K'NEX Limited Partnership Group.  
(ES) K'NEX, Building Worlds Kids Love y America's Building Toy son marcas registradas de K'NEX Limited Partnership Group.



©2014 K'NEX Limited Partnership Group, P.O. Box 700, Hatfield, PA 19440-0700;  
1-800-KID-KNEX (USA/Canada/États-Unis/EE.UU.); email@knex.com; knex.com.  
K'NEX UK Ltd., P.O. Box 3083, Reading RG1 9YQ, England. For customers outside  
the USA/Canada please contact your local distributor at [www.knex.com/distributors](http://www.knex.com/distributors).  
(FR) Pour les clients en dehors du Canada et des États-Unis, veuillez contacter  
votre distributeur local que vous pouvez trouver sur [www.knex.com/distributors](http://www.knex.com/distributors)  
(ES) El cliente que no vive en EE.UU./Canadá se pone en contacto con el distribuidor  
local. Encuentre la información para el distribuidor local en [www.knex.com/distributors](http://www.knex.com/distributors)

(EN) Product & colors may vary. Most models can be built one at a time.  
(FR) Le produit et ses couleurs peuvent varier. Les différents modèles ne peuvent être construits qu'un par un.  
(ES) El producto y los colores pueden variar. La mayoría de los modelos se pueden construir uno a la vez.  
(DE) Produkte und Farben können abweichen. Die meisten Modelle können immer nur einzeln gebaut werden.  
(IT) Prodotti e colori possono differire. La maggior parte dei modelli si può costruire autonomamente.  
(PT) O produto e as cores podem variar. A maioria dos modelos pode ser montado um de cada vez.  
(NL) Product en kleuren kunnen variëren. De meeste modellen kunnen uitsluitend een voor een worden gebouwd.

114579-V1-05/14