



100 MODEL IMAGINE BUILDING SET

MISCELLANEOUS



Camera
page 1

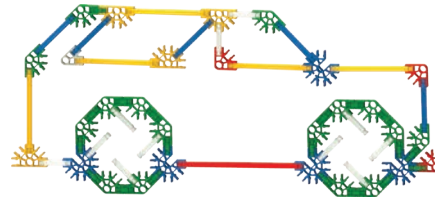

Car
page 12



Drum Kit
page 13

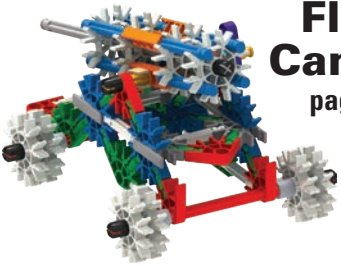

Flick Cannon
page 20



Gravitron
page 24



Guitar
page 31



Mech
page 38



Metal Detector
page 47

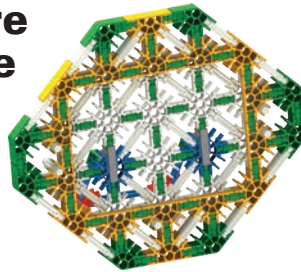

Picture Frame
page 55

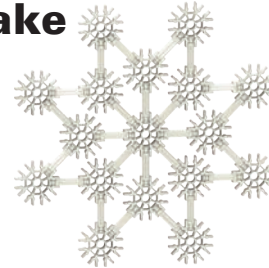

Snowflake
page 58



Spinning Top
page 59



Starburst
page 60



Table Tennis
page 61

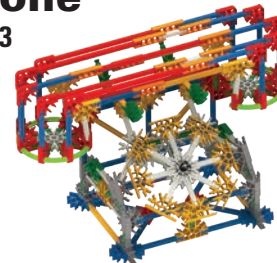

Telephone
page 63

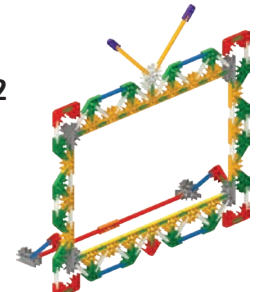

TV
page 72

Camera

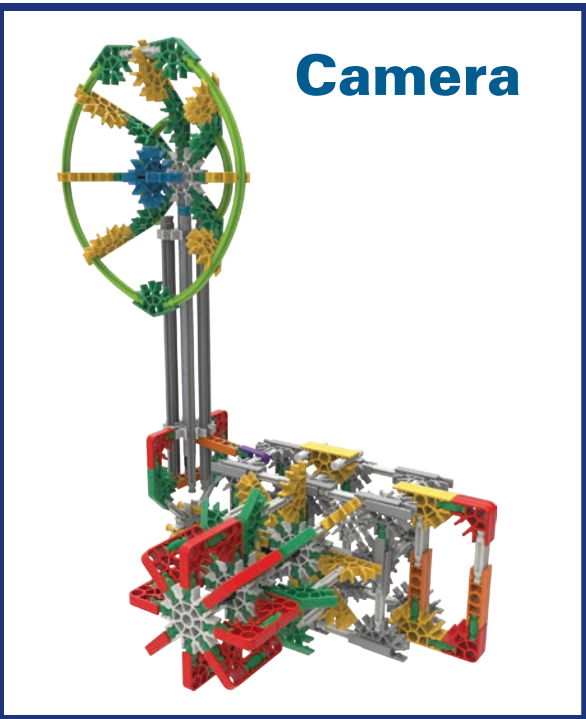

x2

1

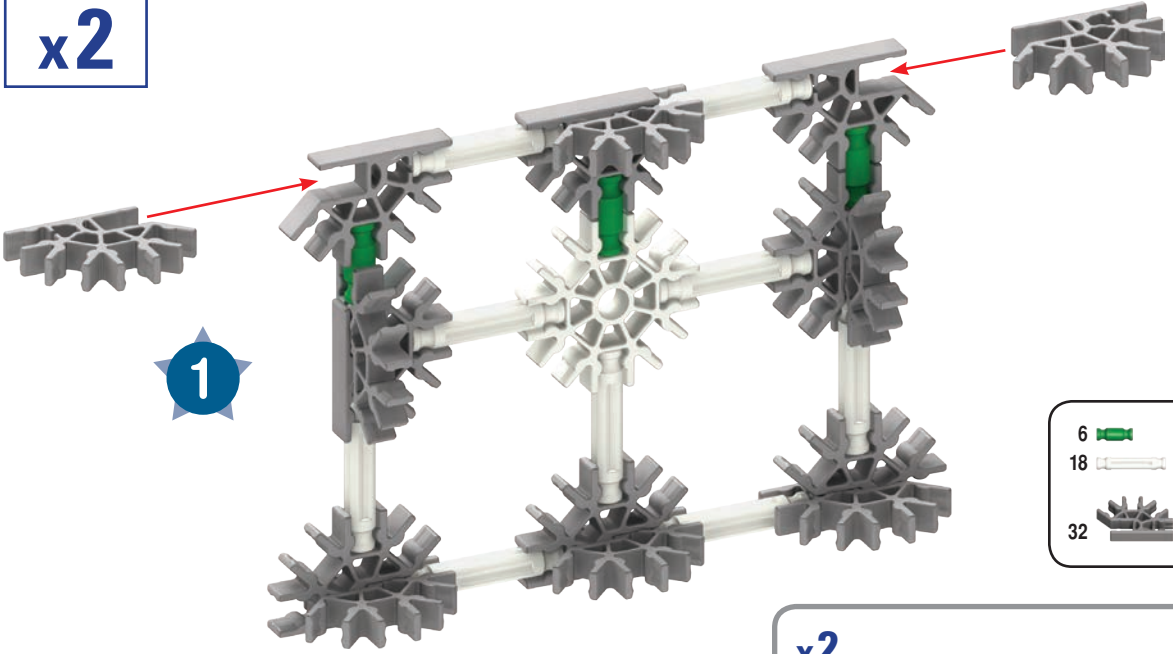

- 6
- 18
- 32
- 2

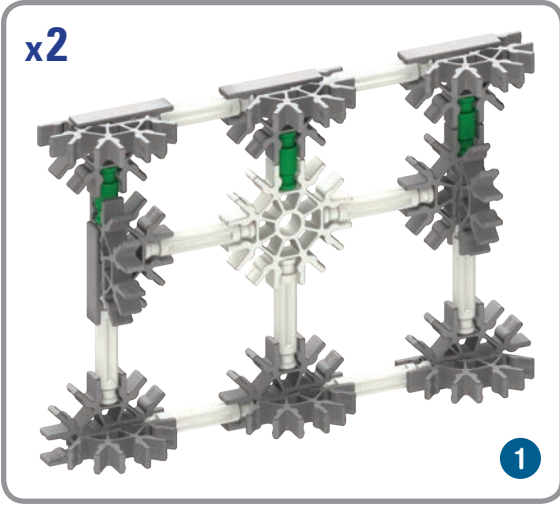

x2

1

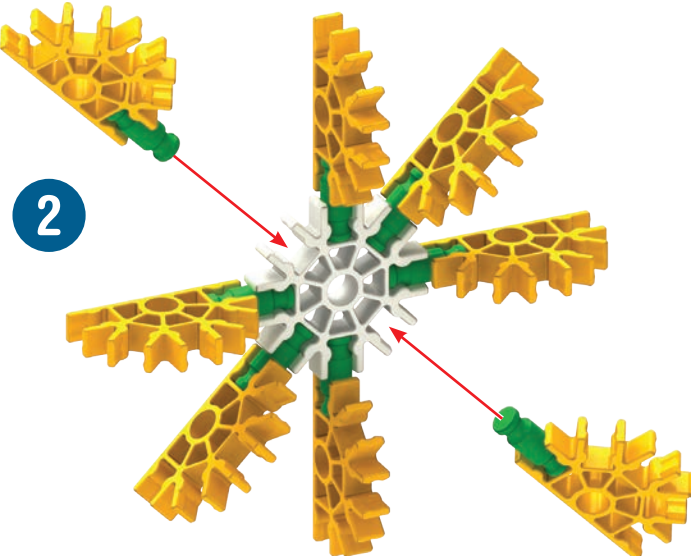

2

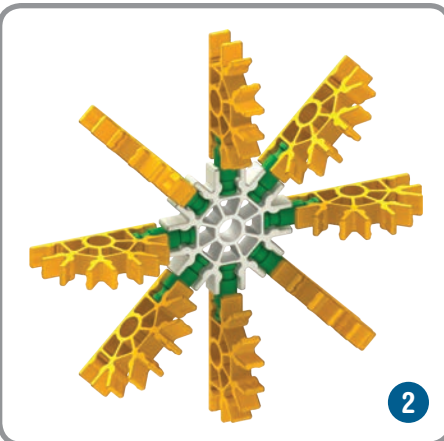

2

- 8
- 8
- 1

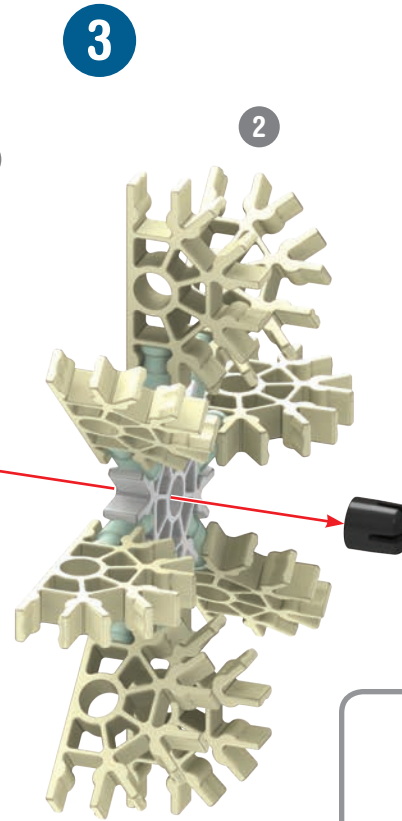
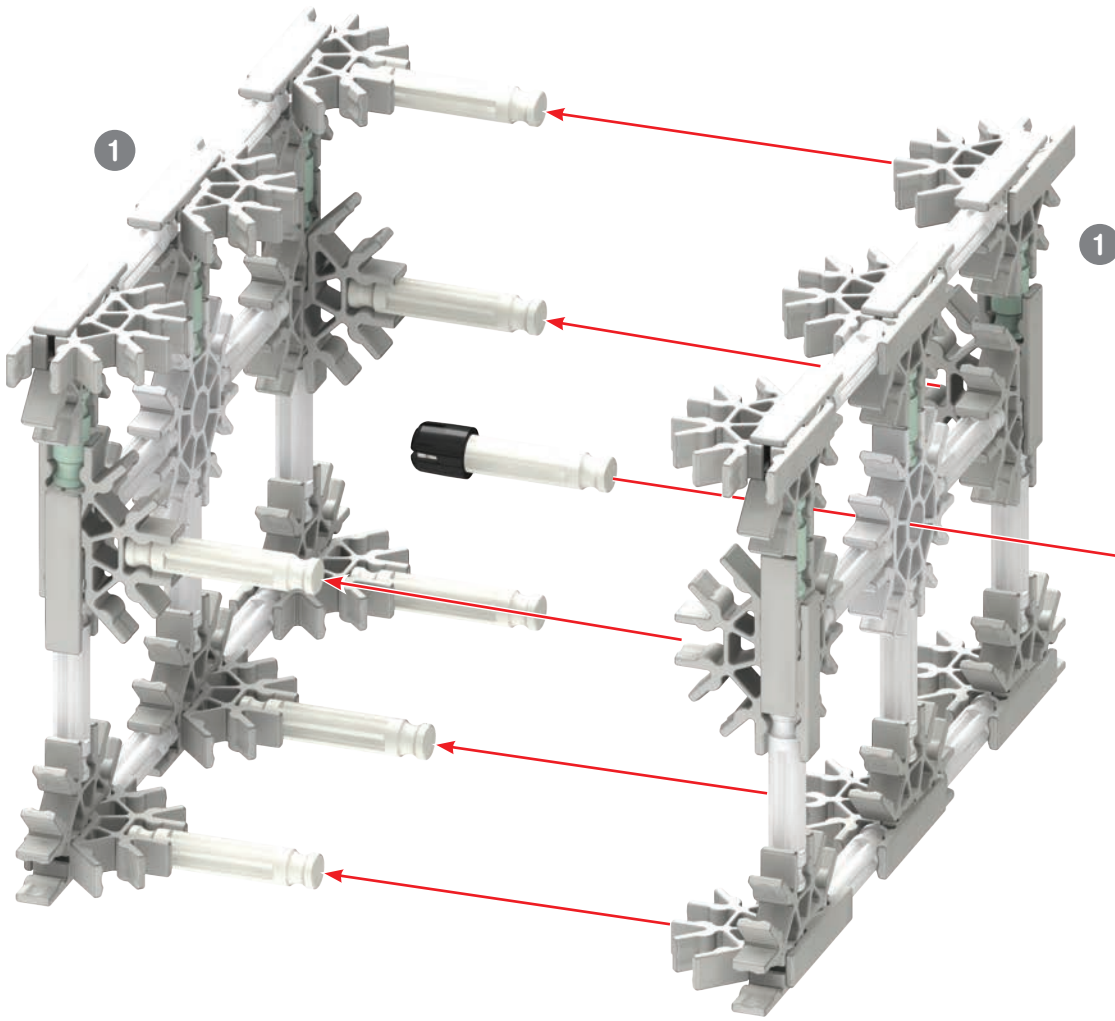

- 2 
- 7 

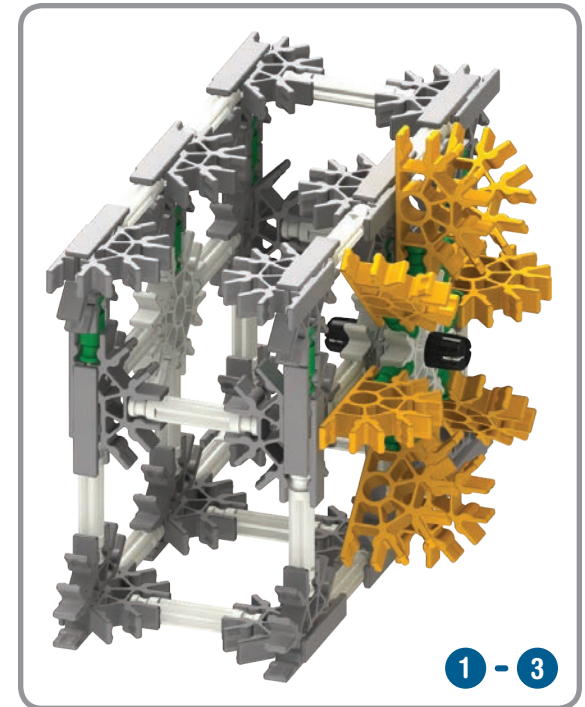

4

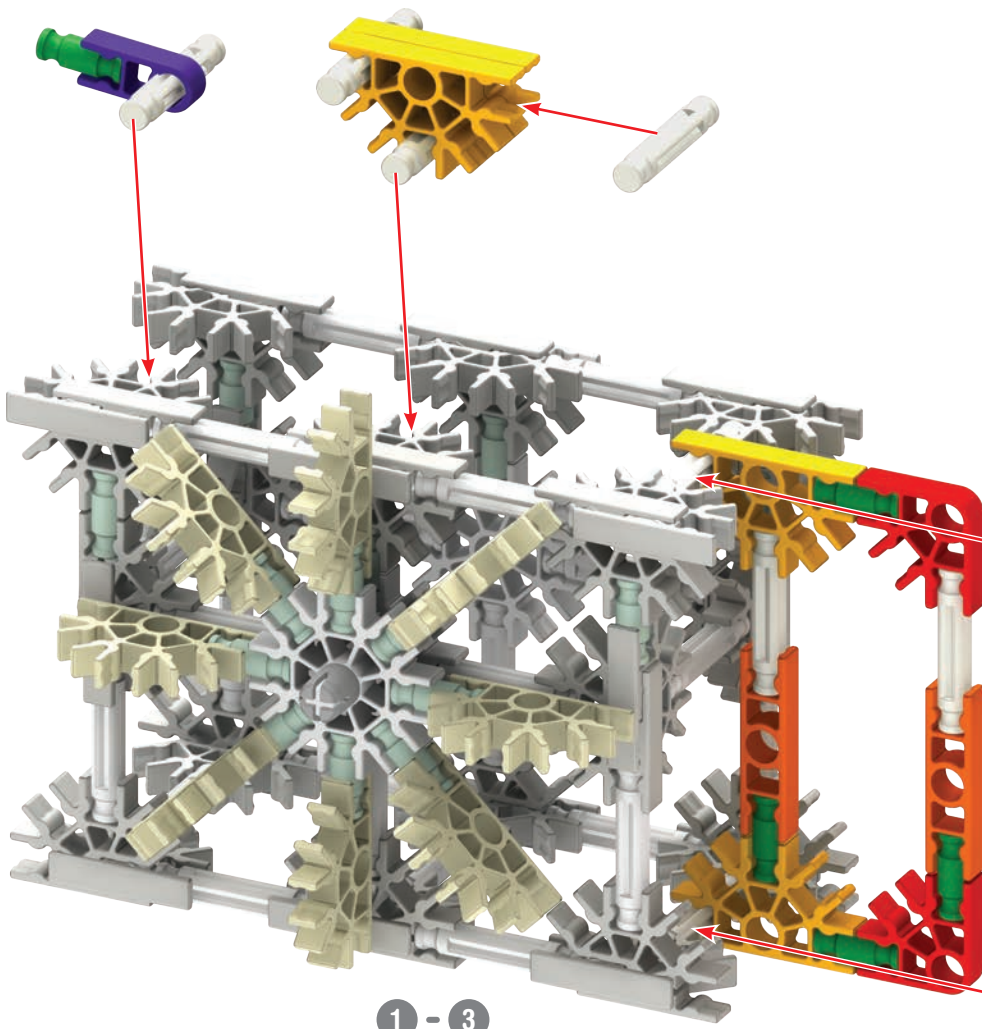

1 - 3

5

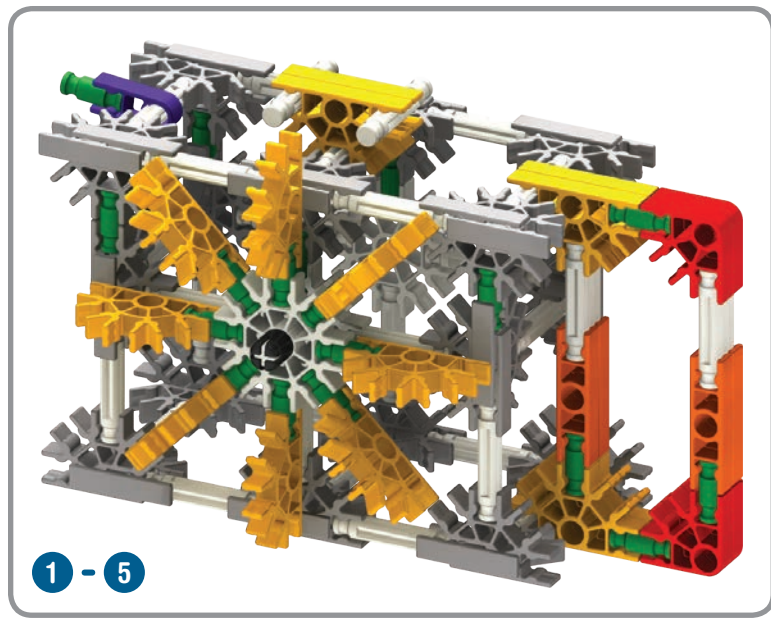

1 - 5

9		6		
8		4		4
1				

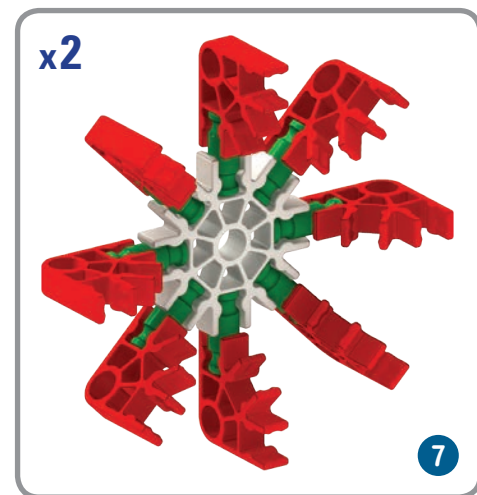
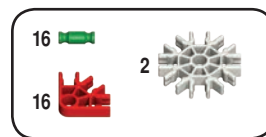
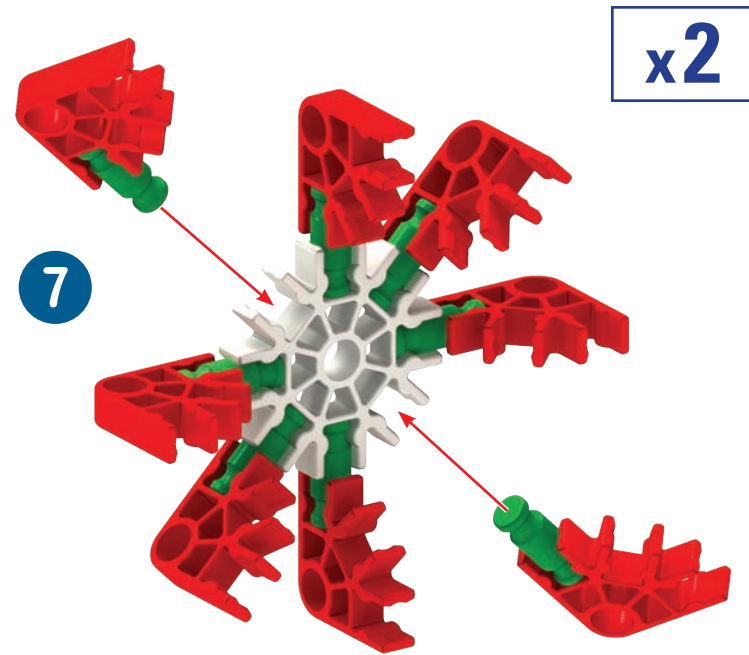
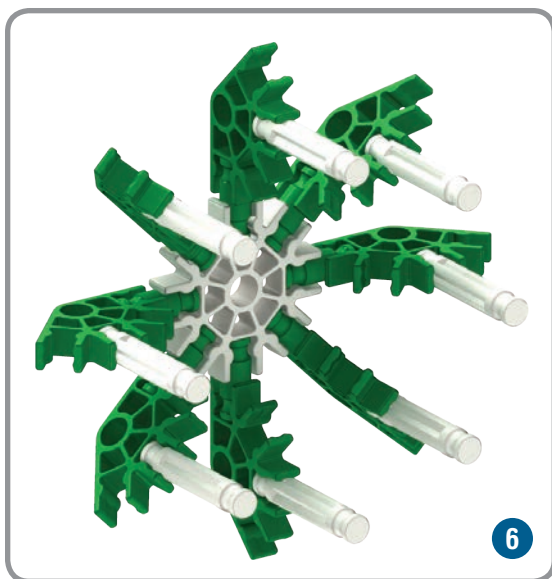
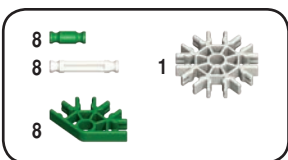
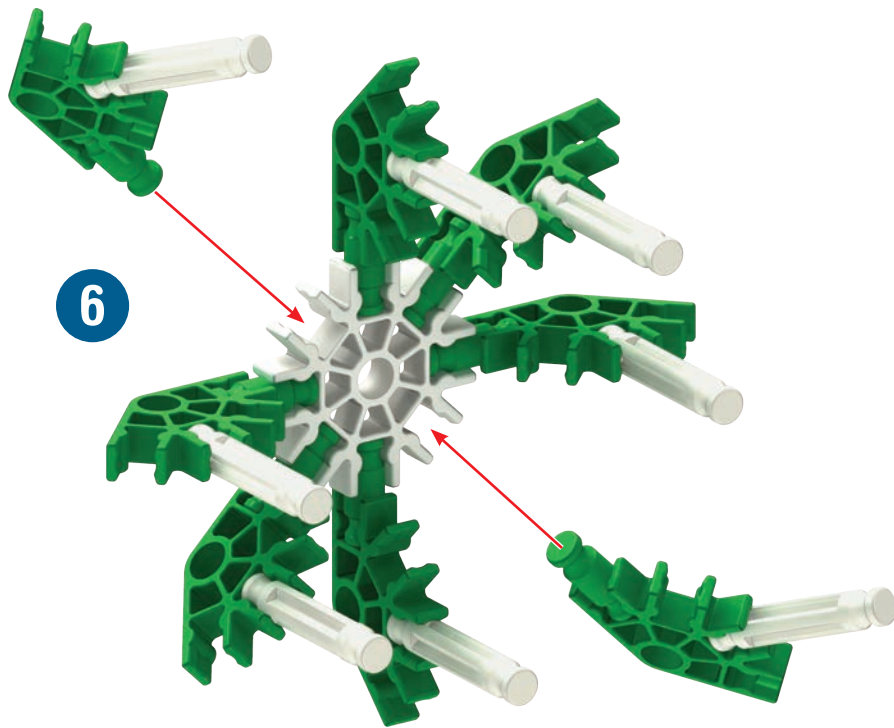

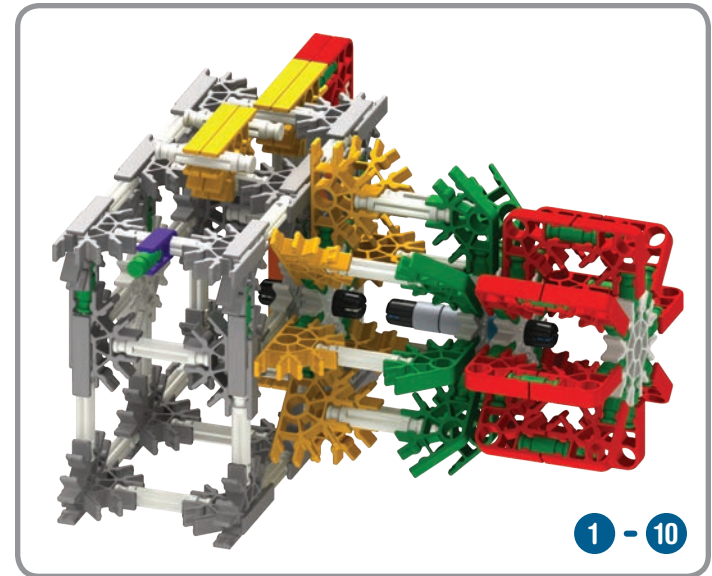
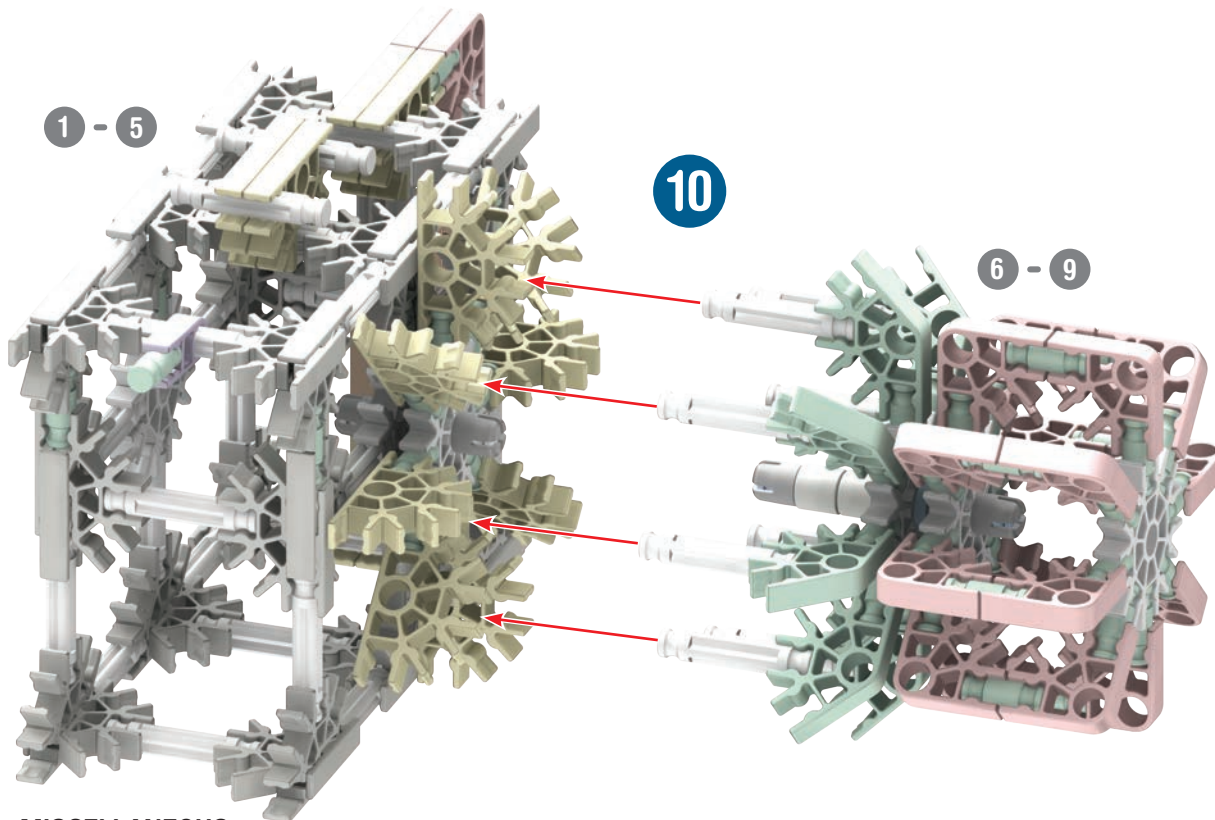
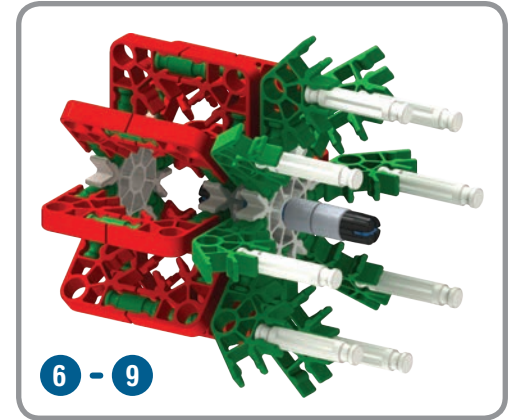
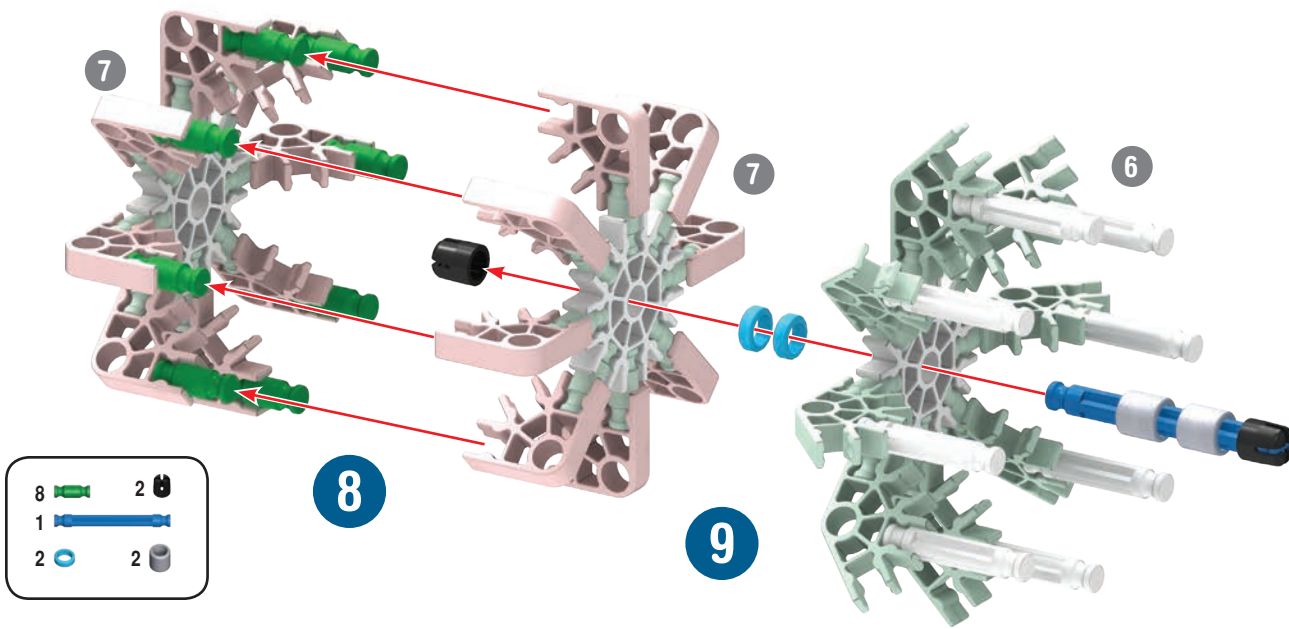

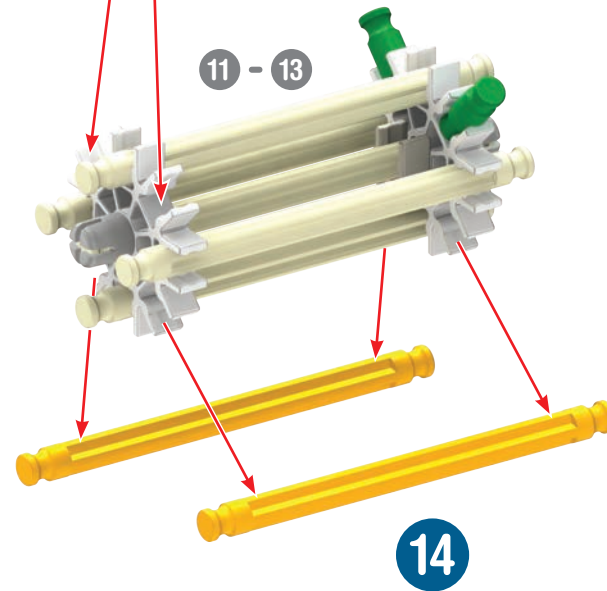
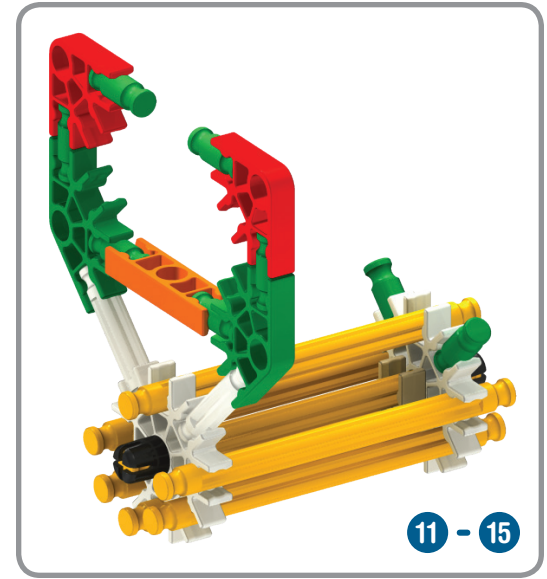
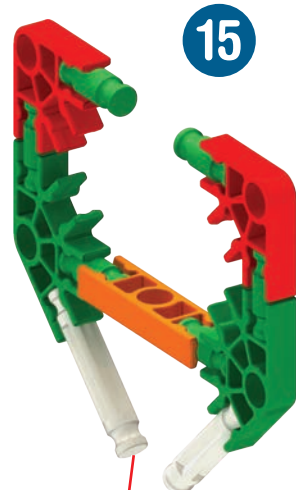
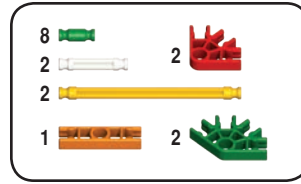
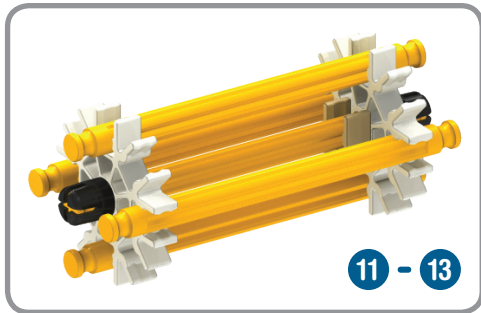
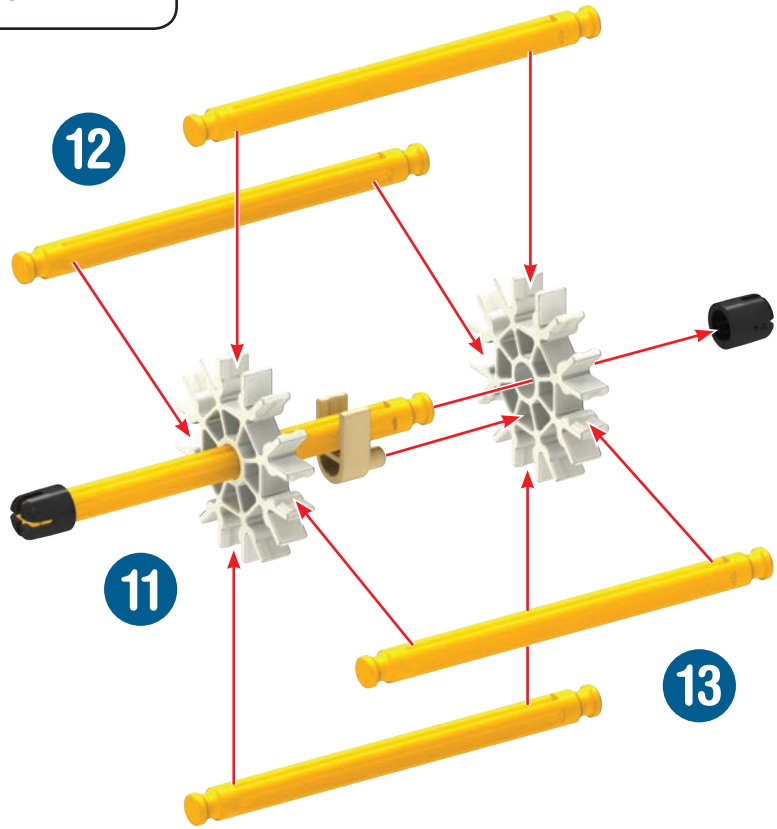
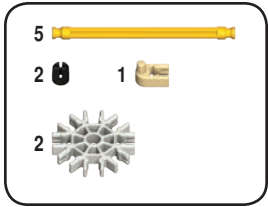

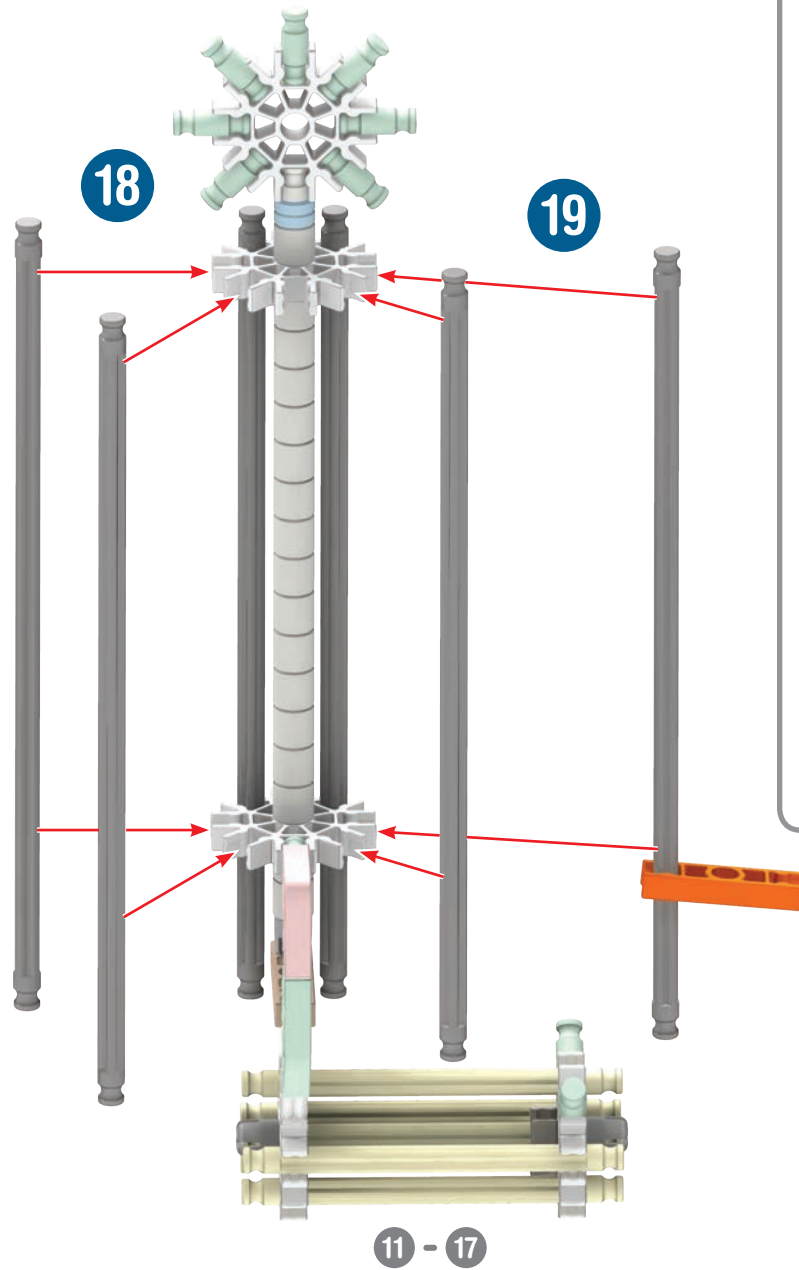
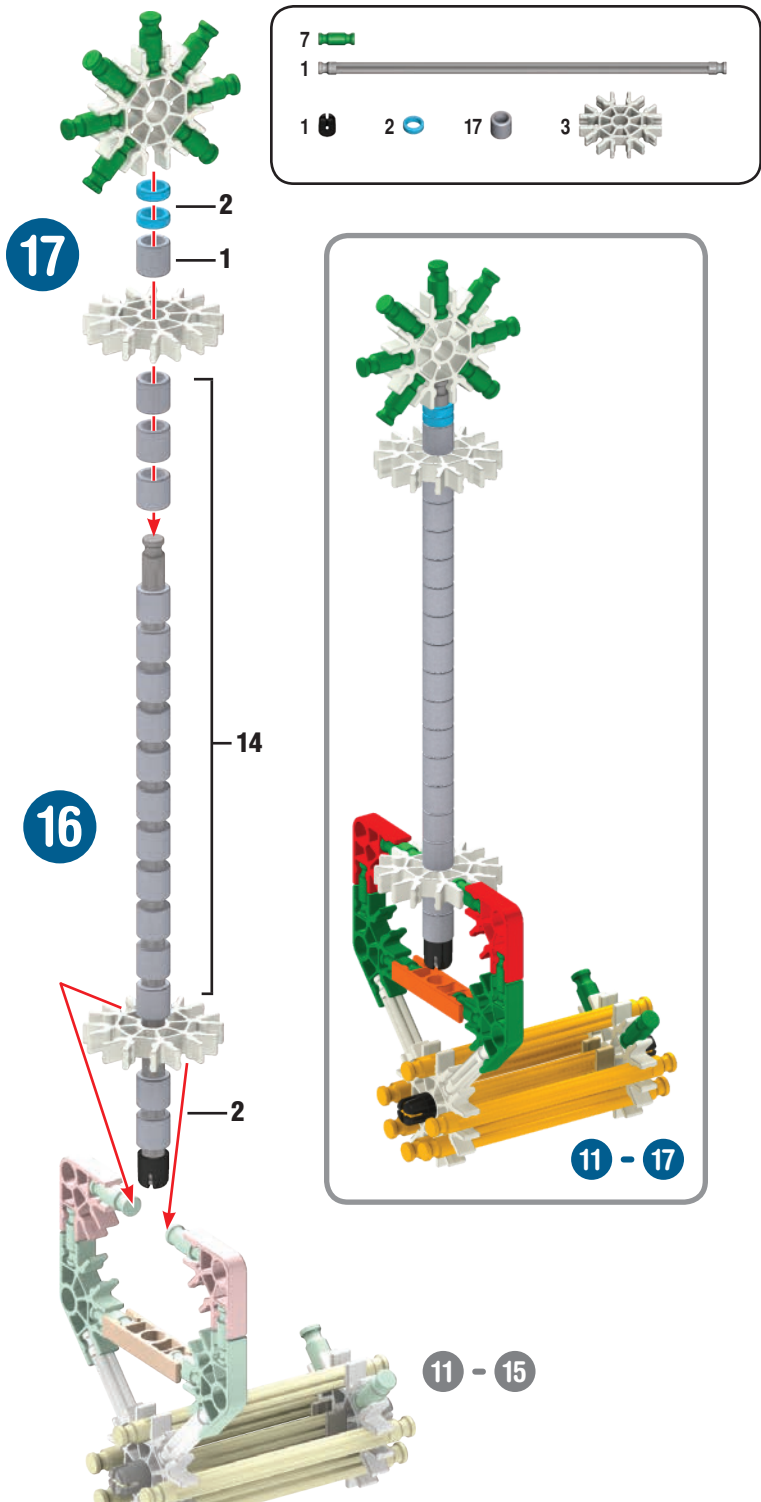

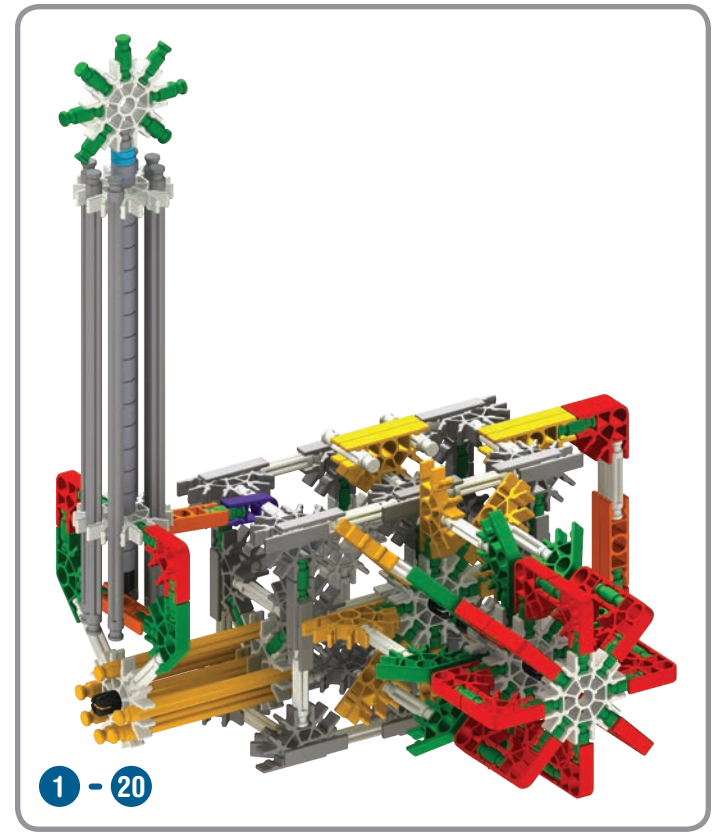
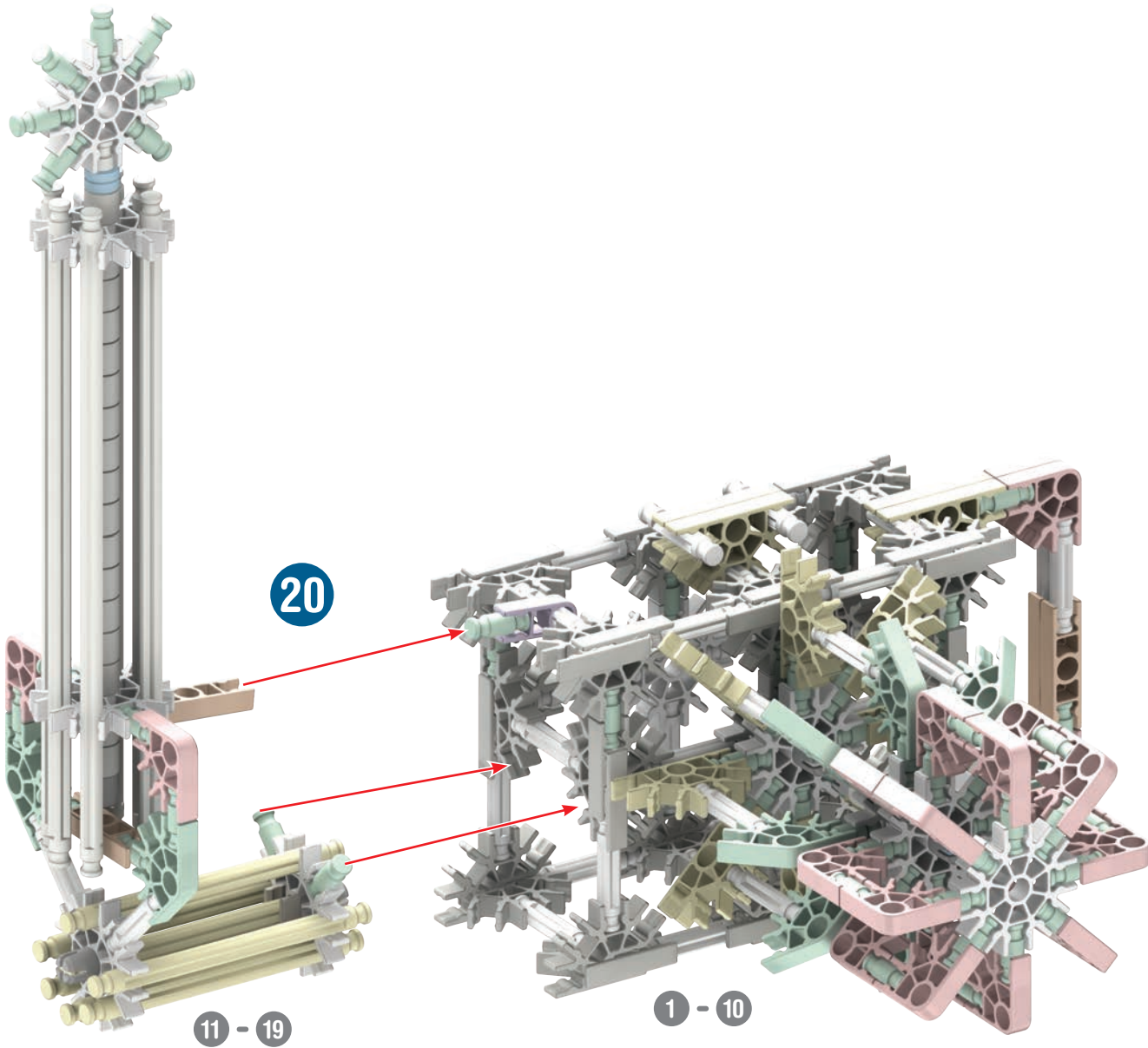

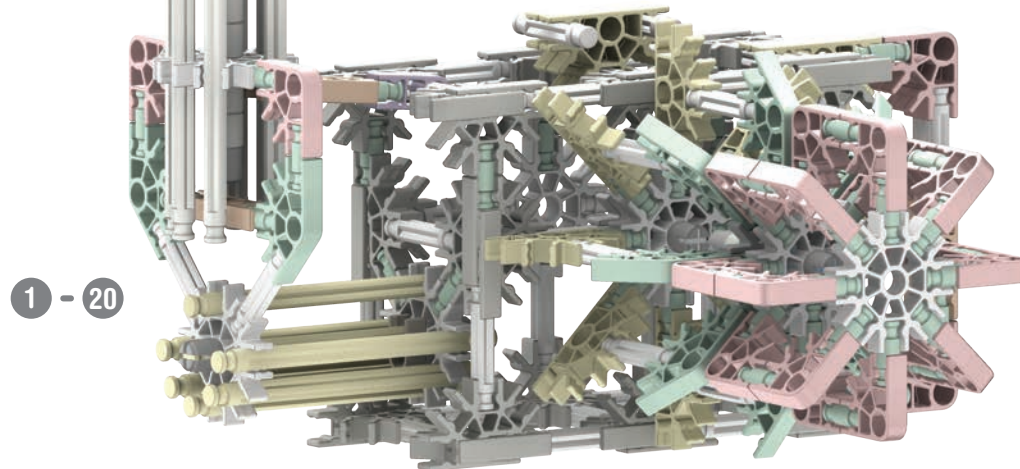
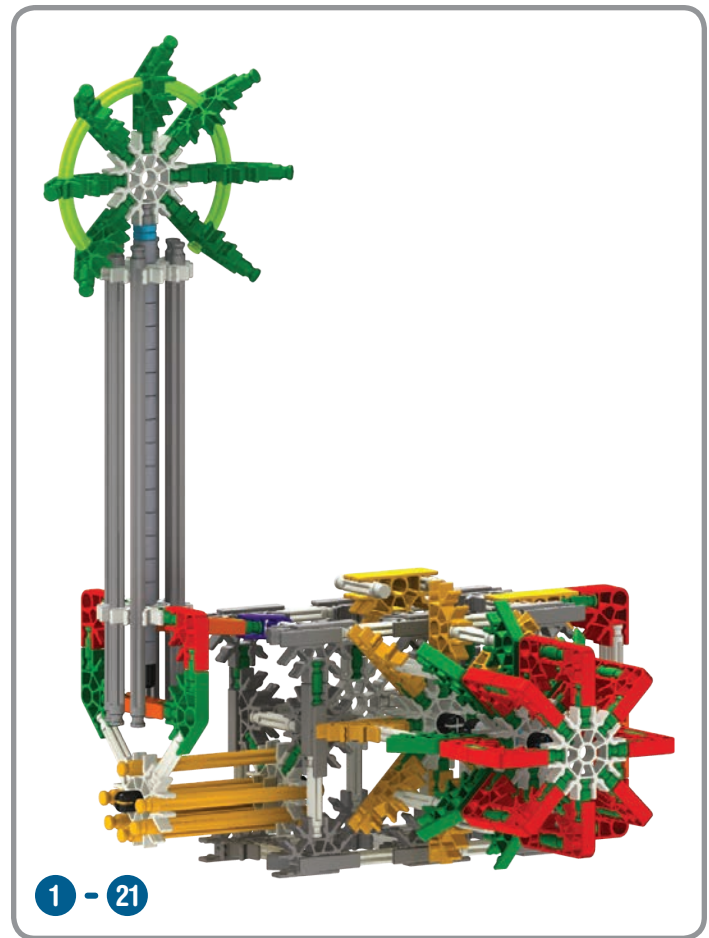
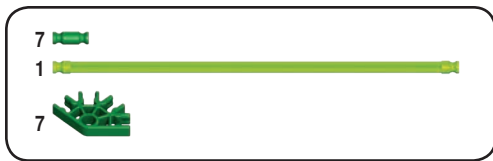
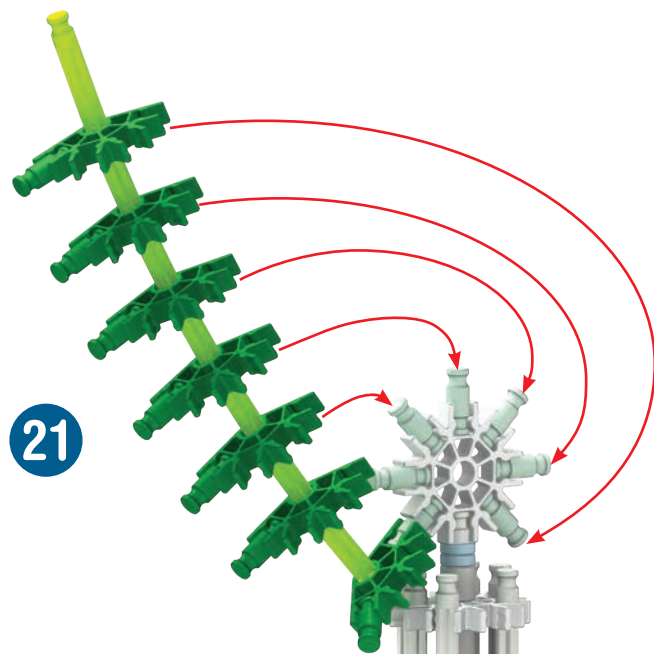

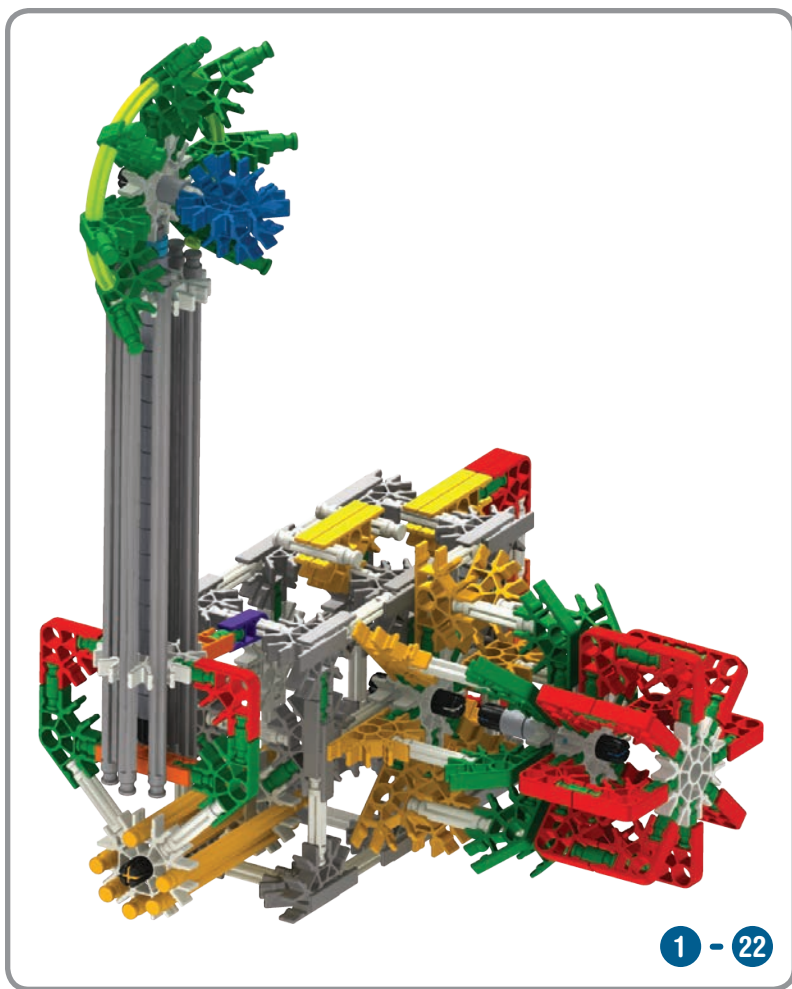
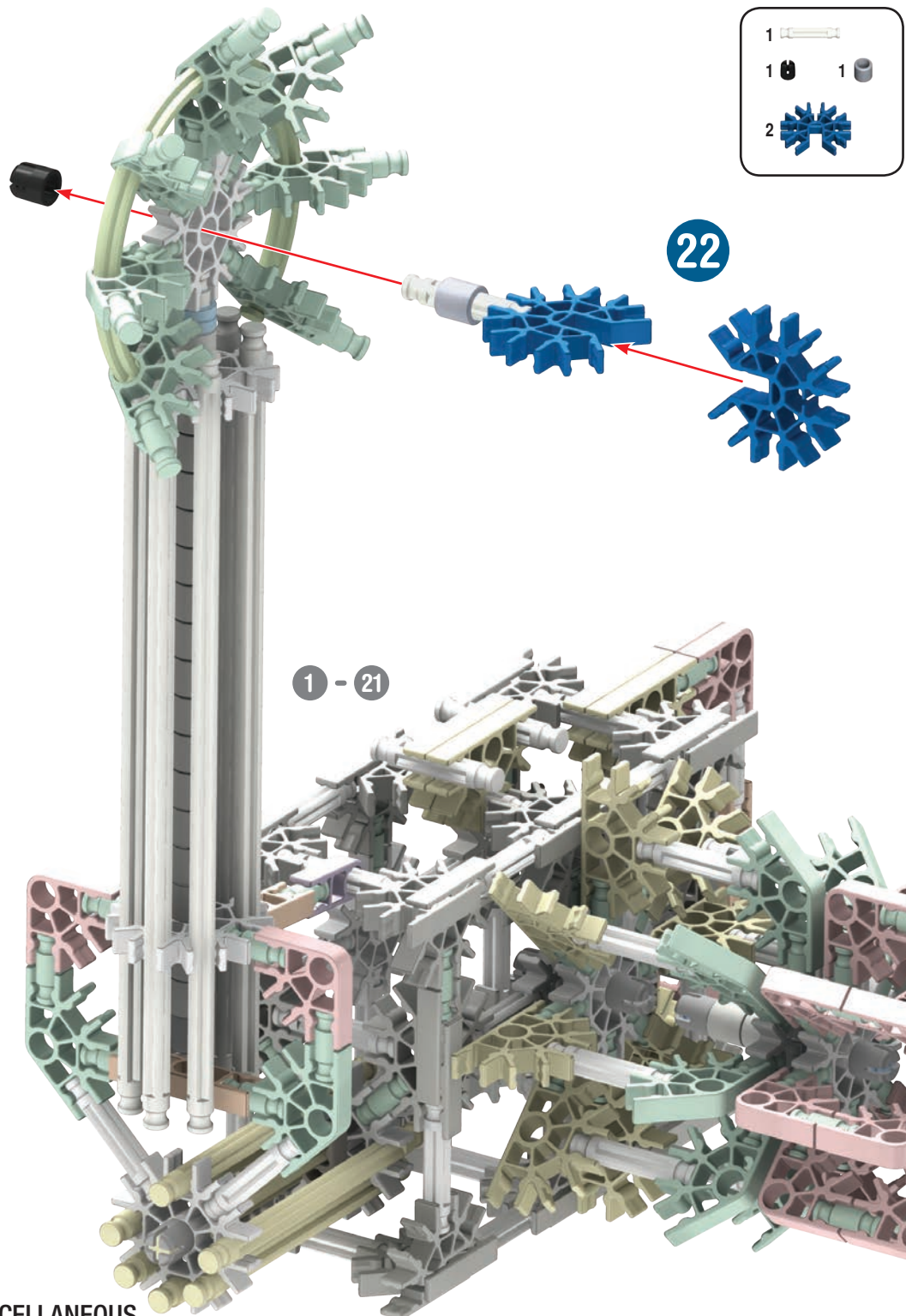

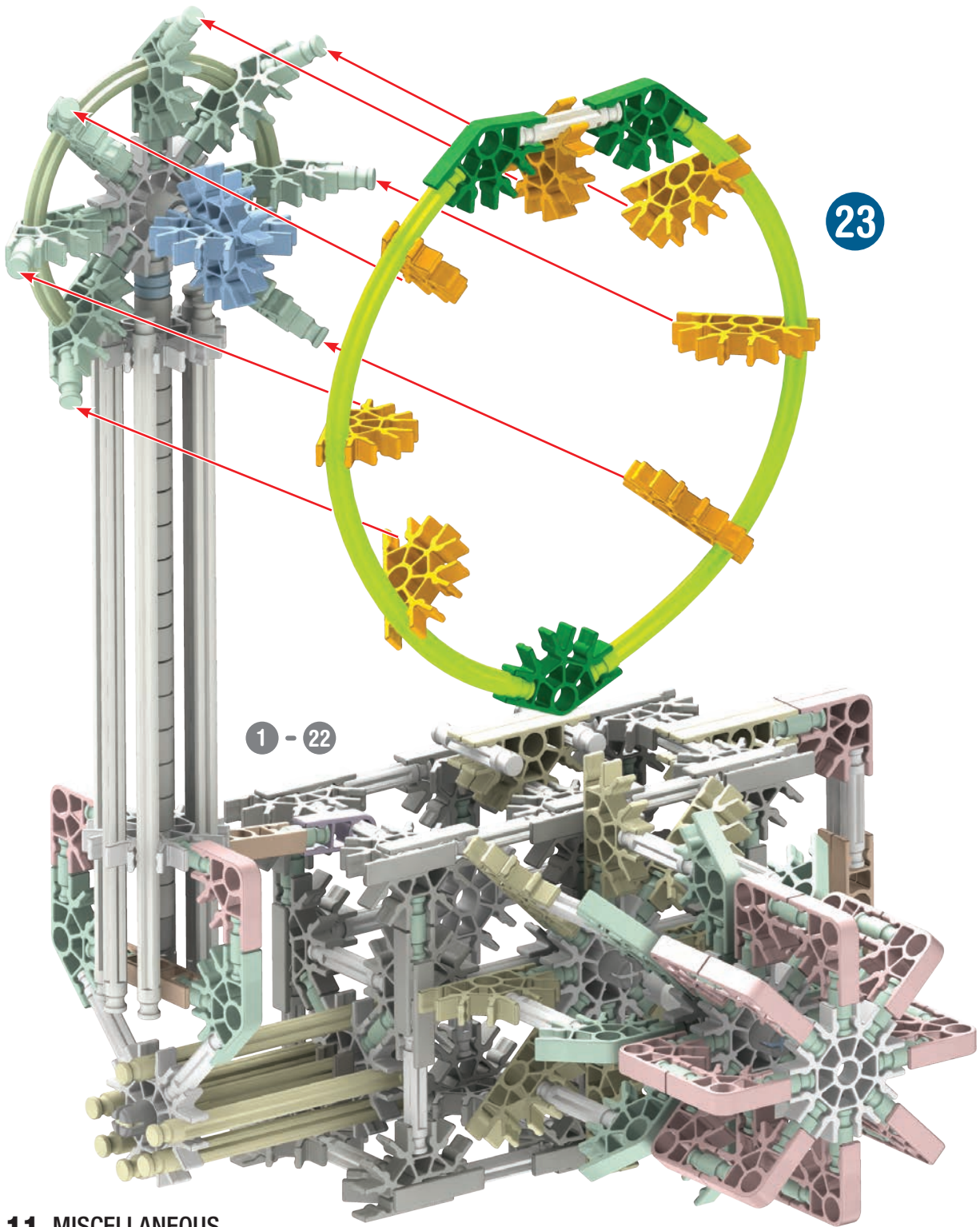

23

1 - 22



Camera

1 - 23

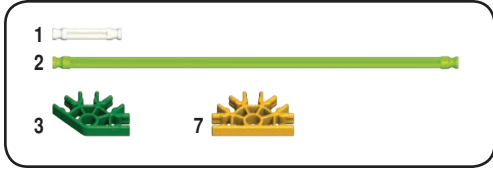

Car

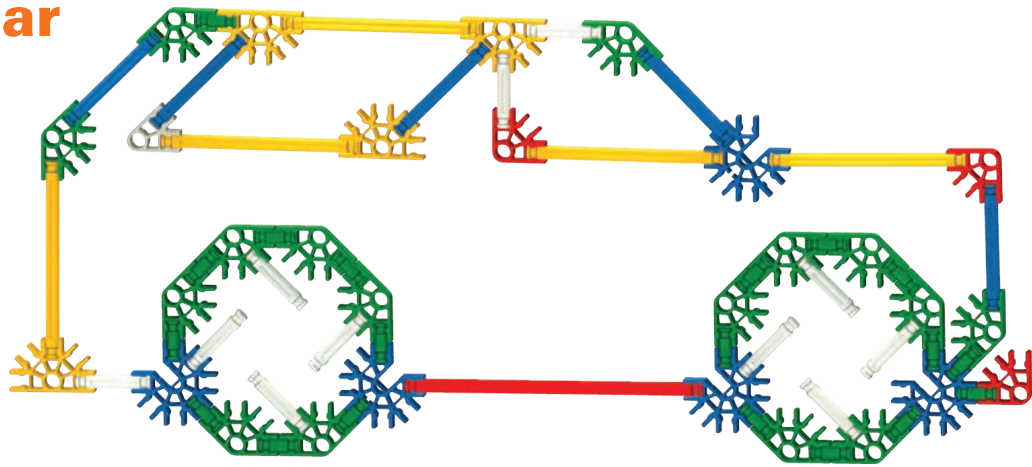

19		4		5	
11					
5					
5					
1					
1		3		16	

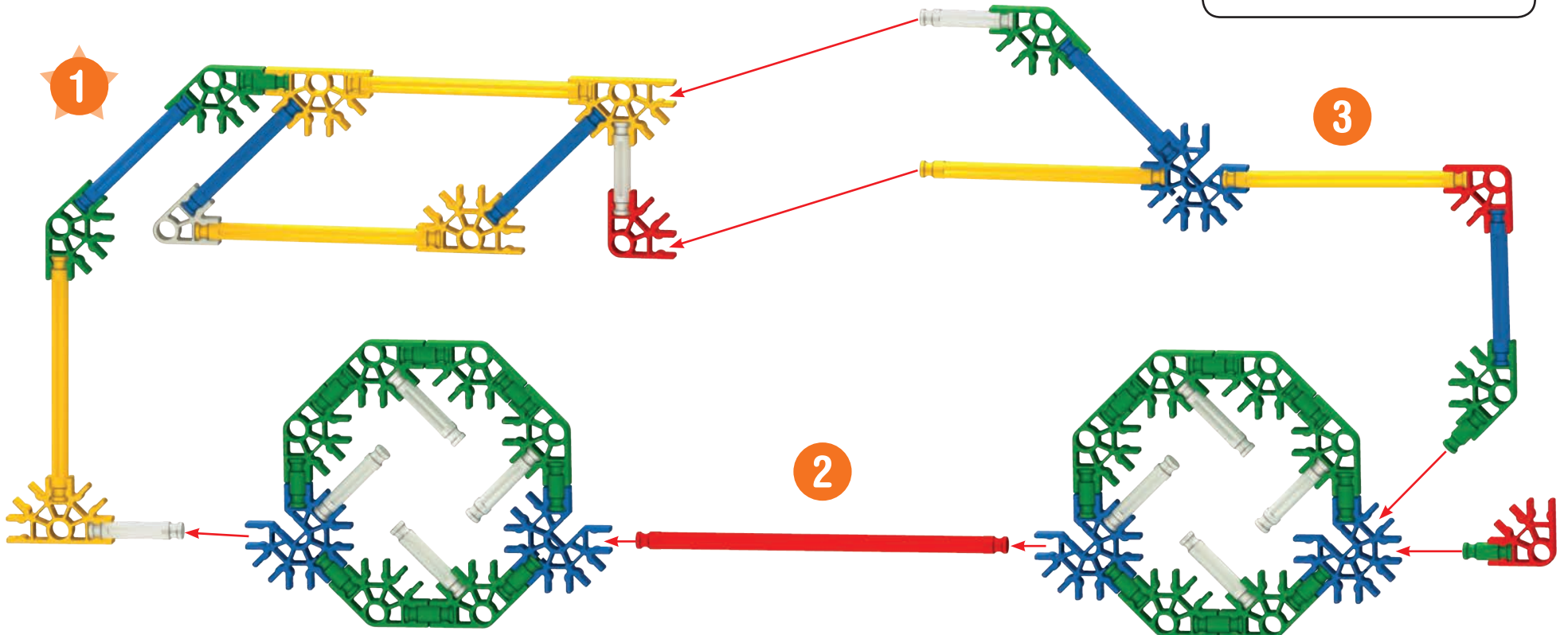

Drum Kit

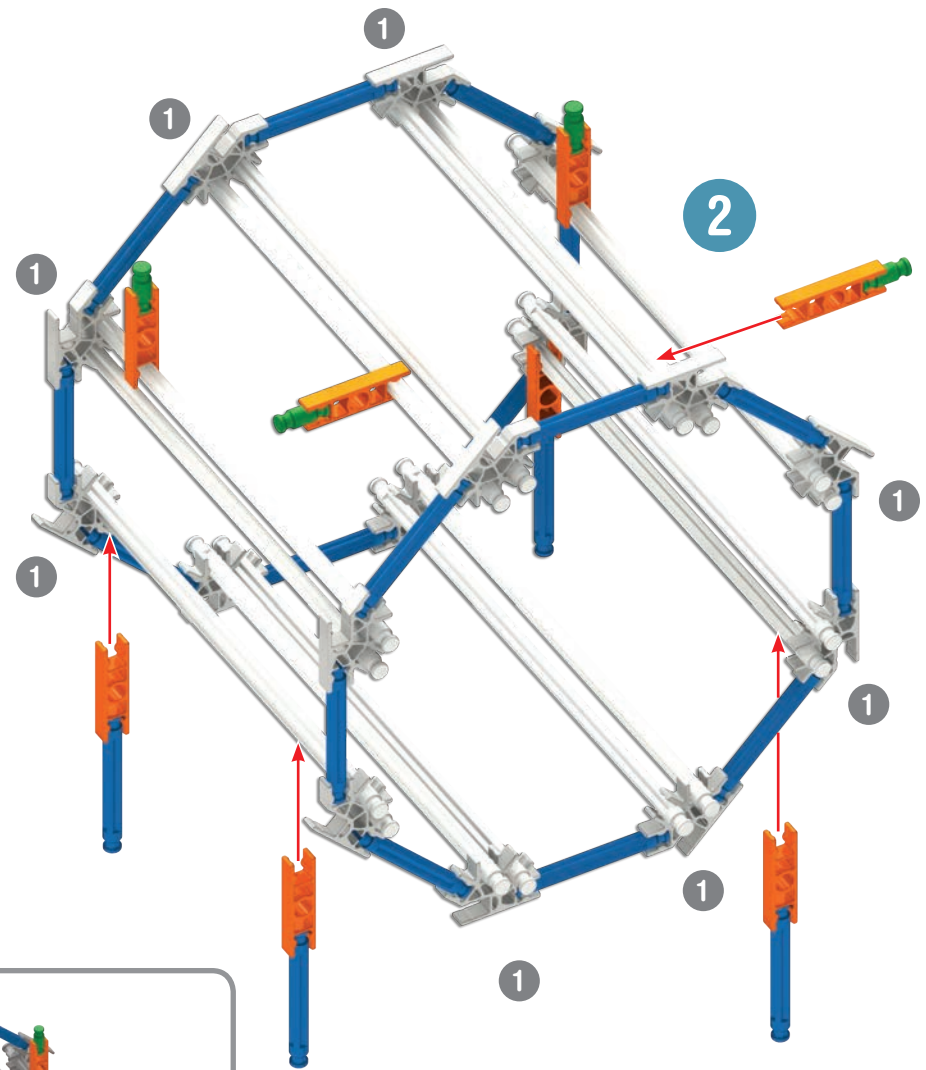
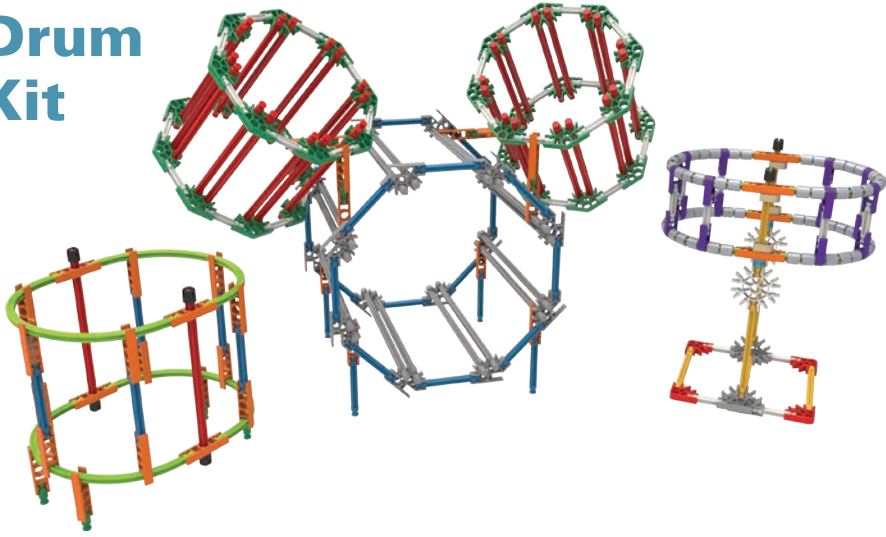

x8

1

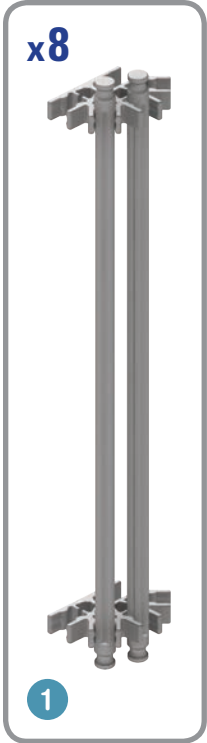

x8

1

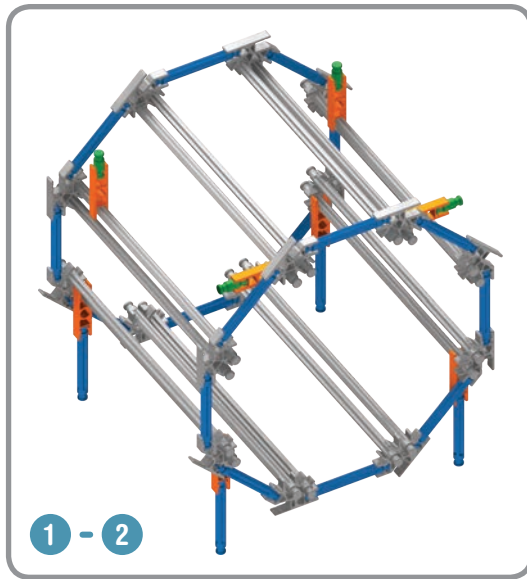

1 - 2

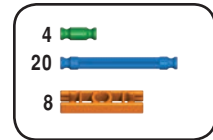

x16

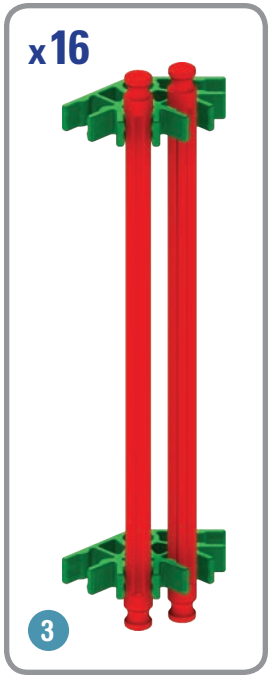
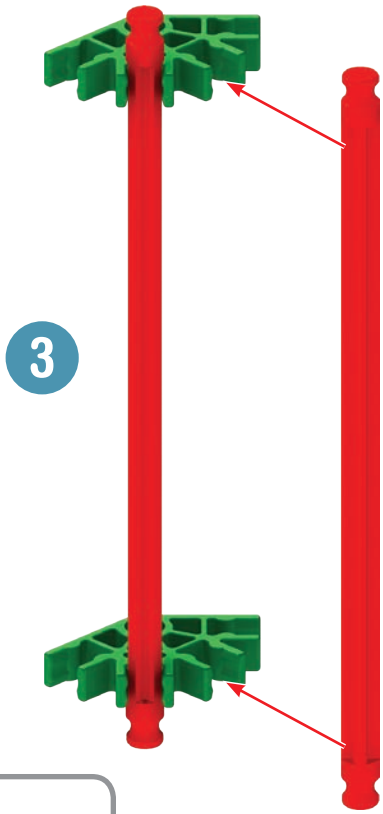

x2

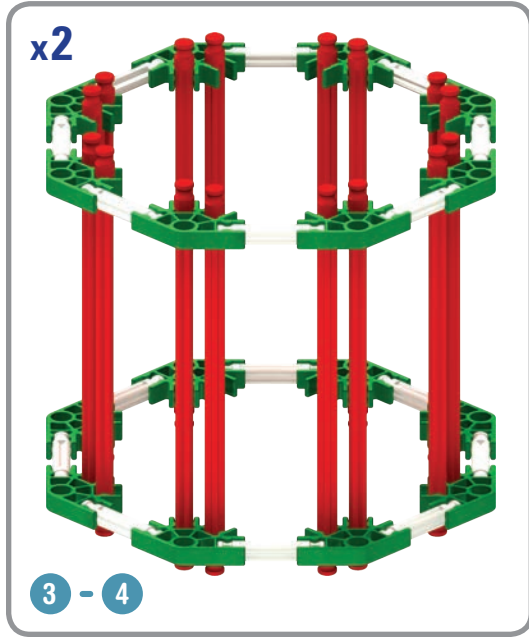
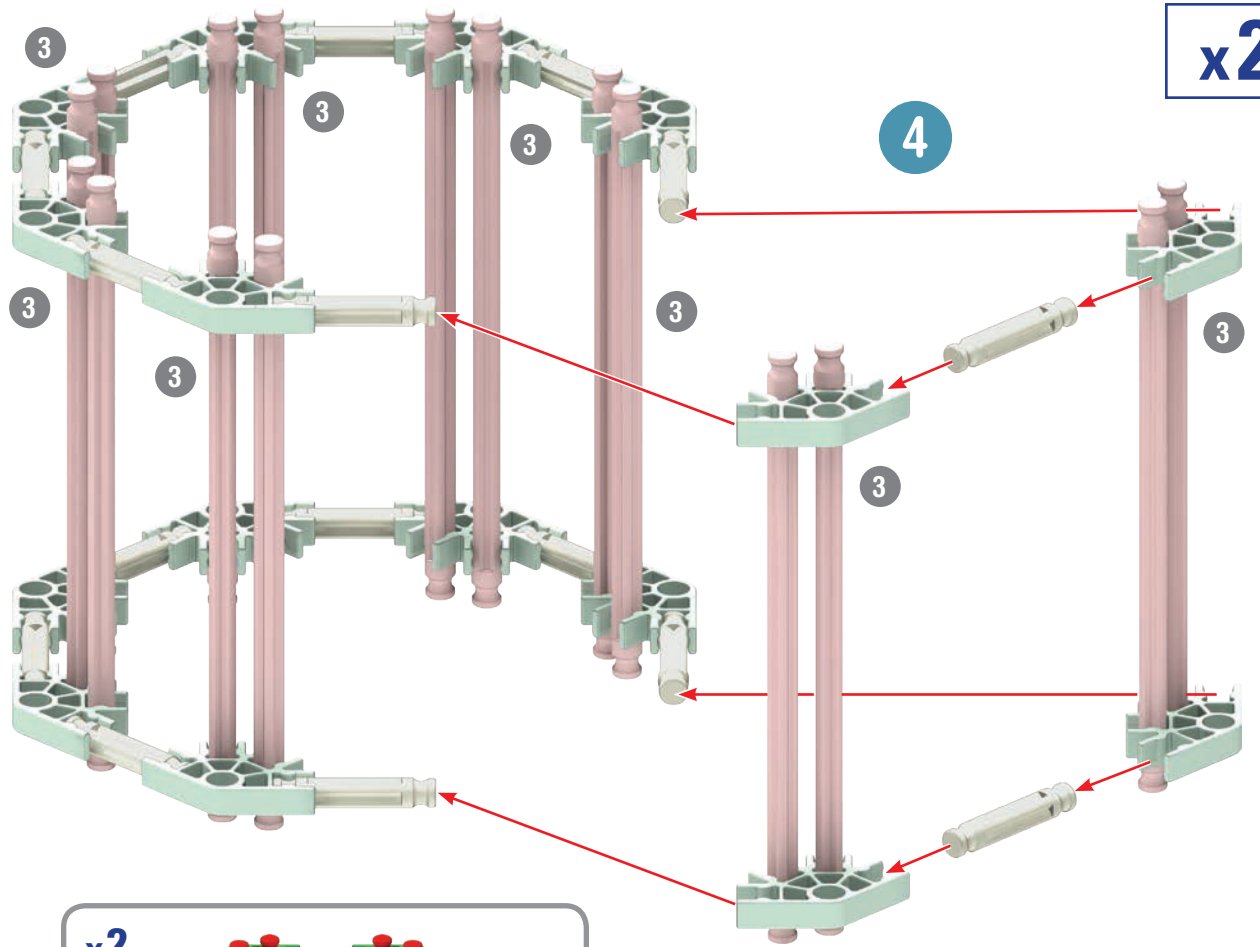

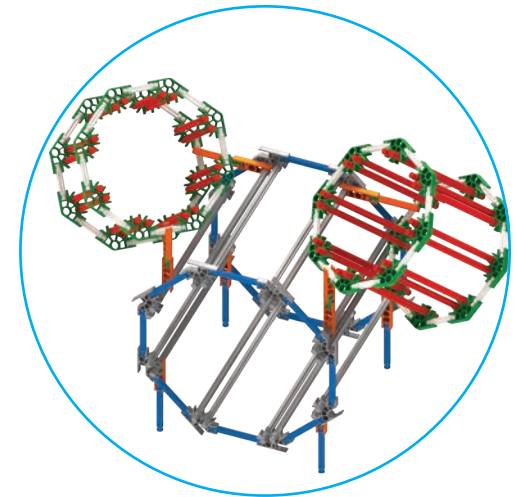
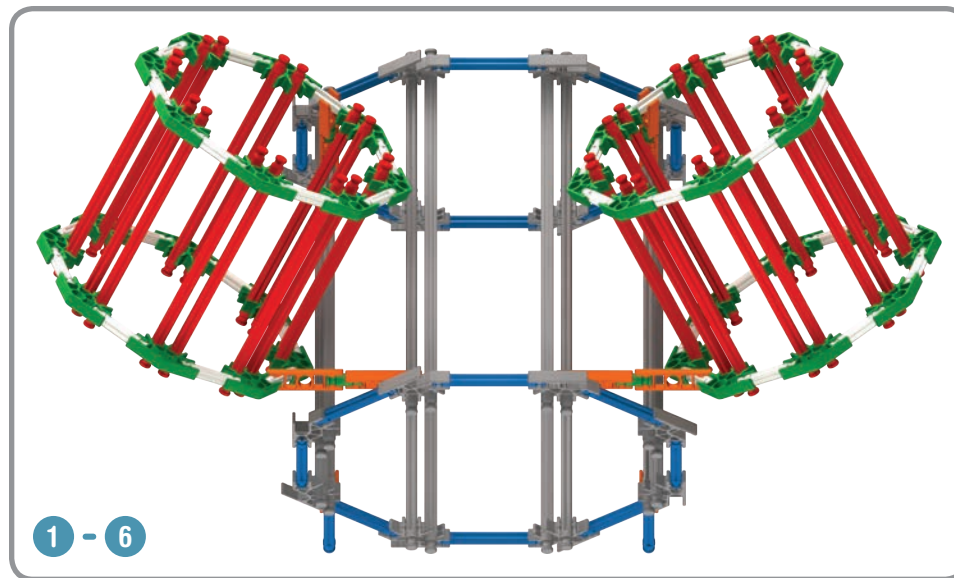
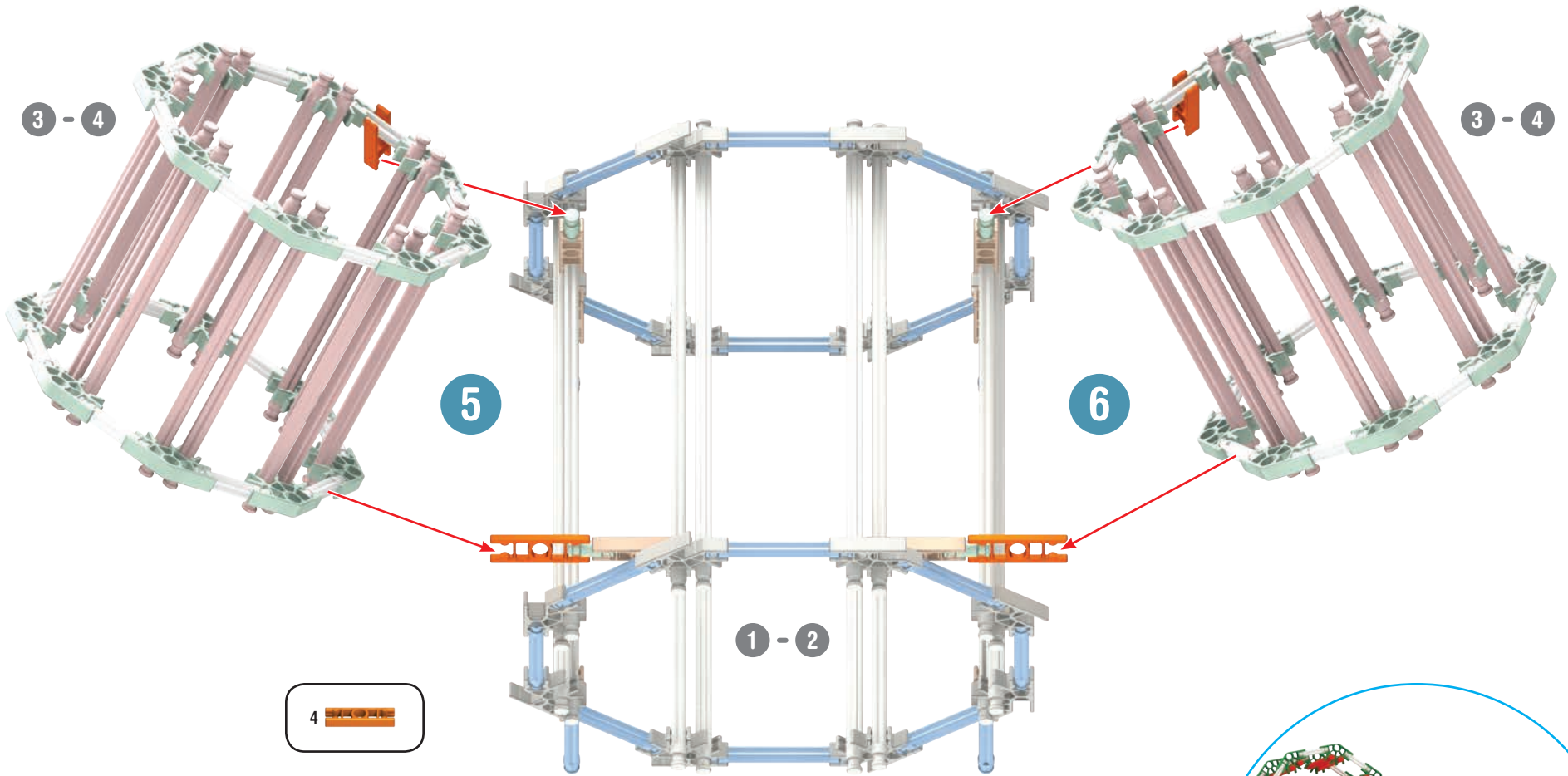

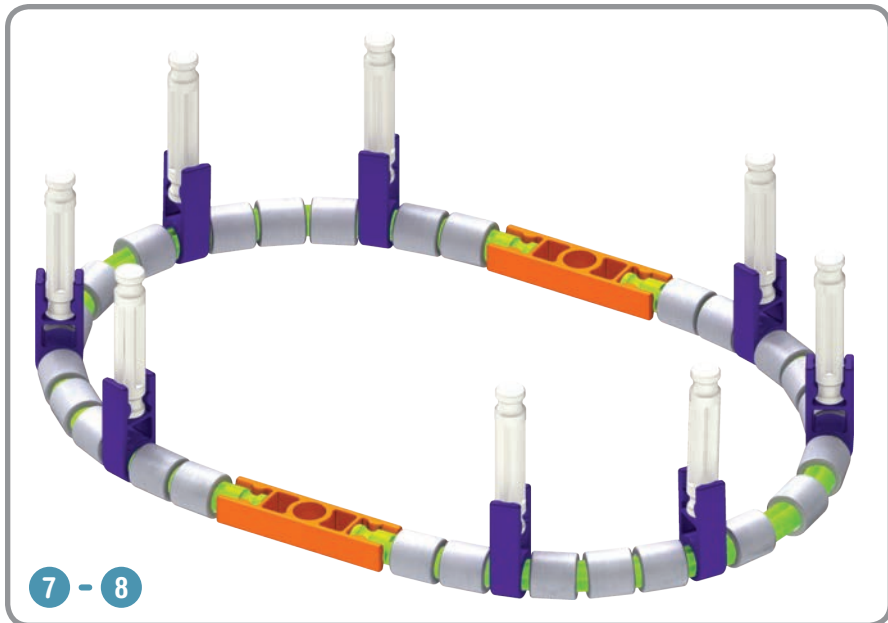
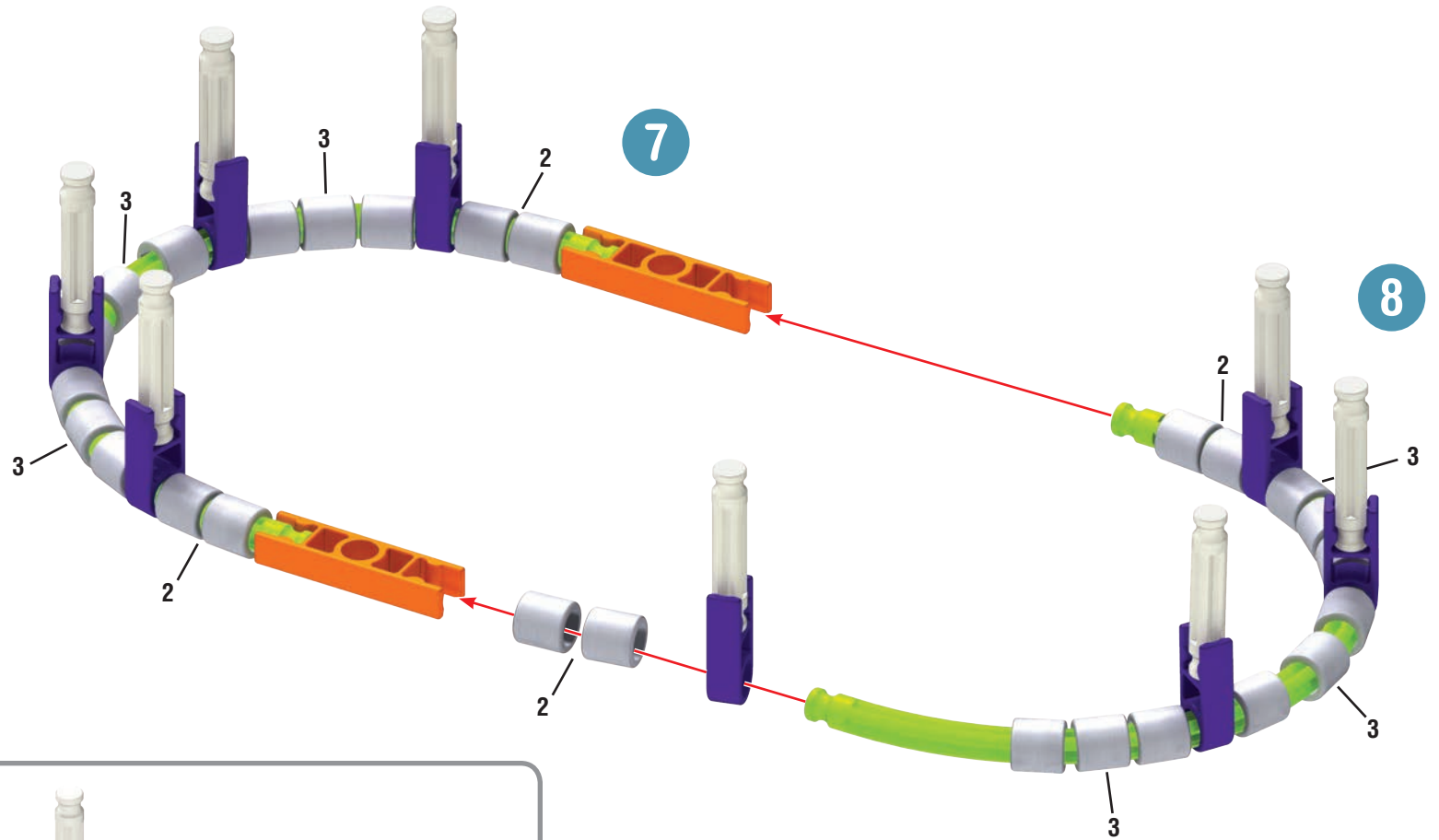

- | | | | | | |
|----|--|---|--|---|--|
| 26 | | 8 | | 2 | |
| 8 | | | | | |
| 2 | | | | | |

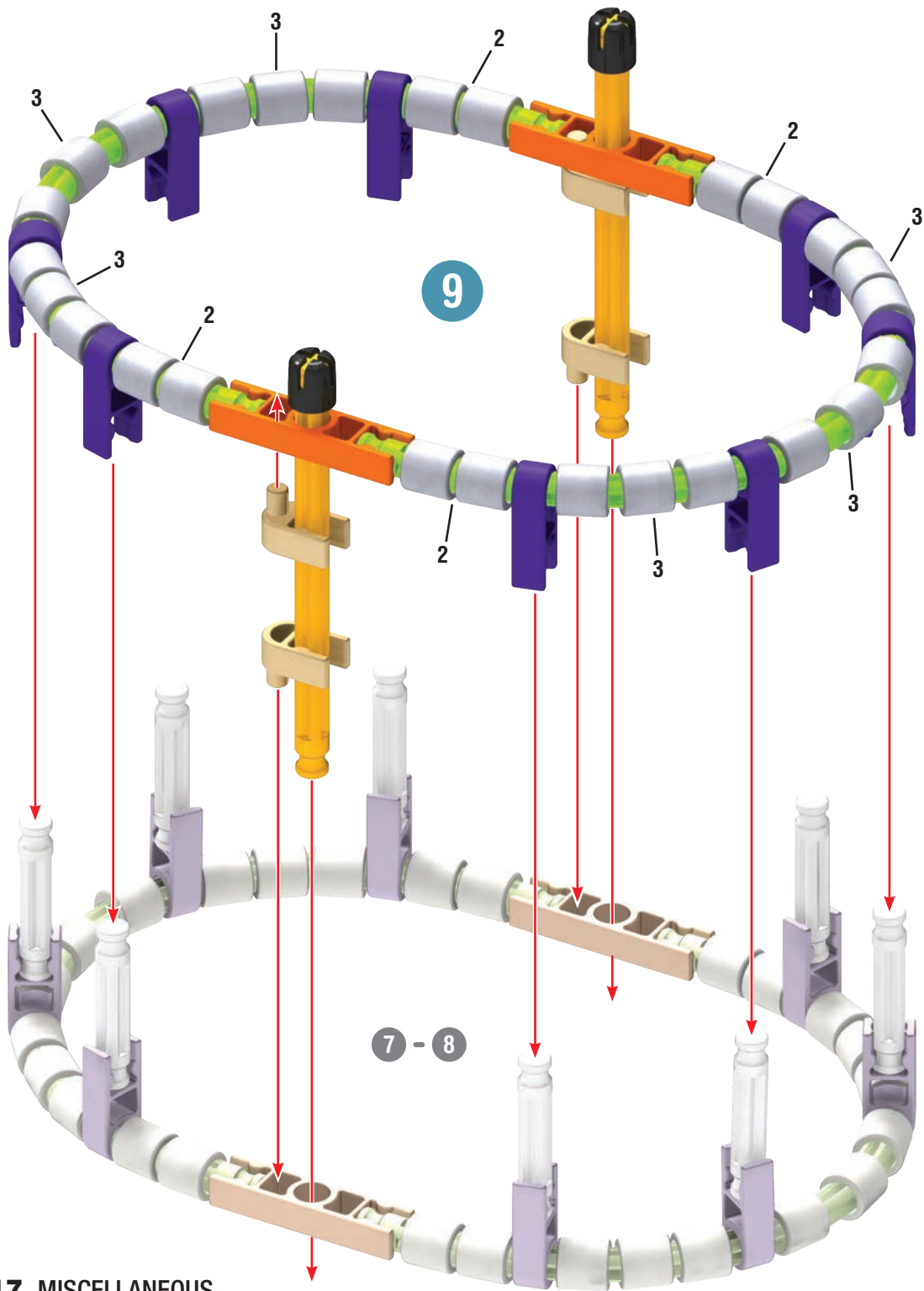

- | | | | | | |
|---|--|---|--|----|--|
| 2 | | 2 | | 26 | |
| 2 | | | | | |
| 4 | | 8 | | 2 | |

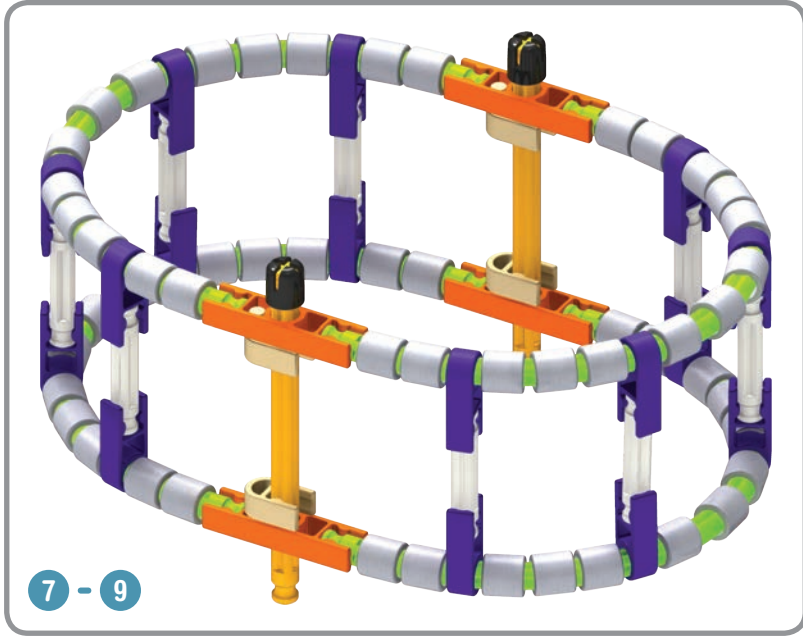

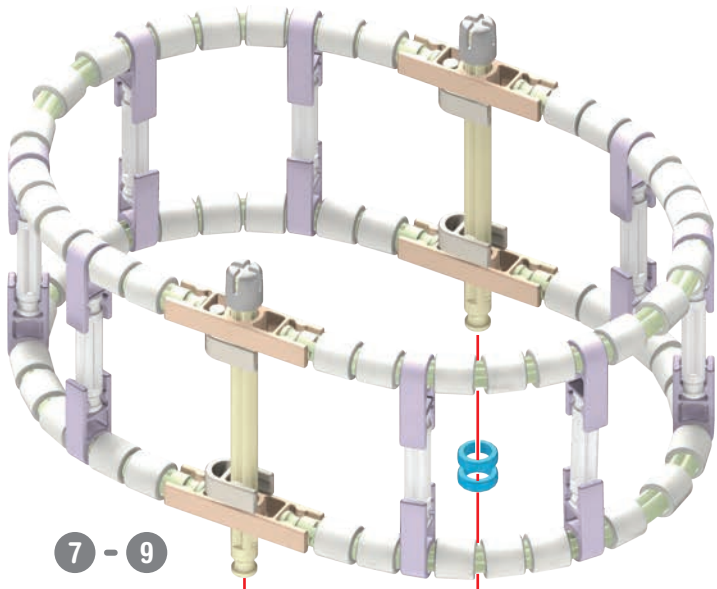

7 - 9

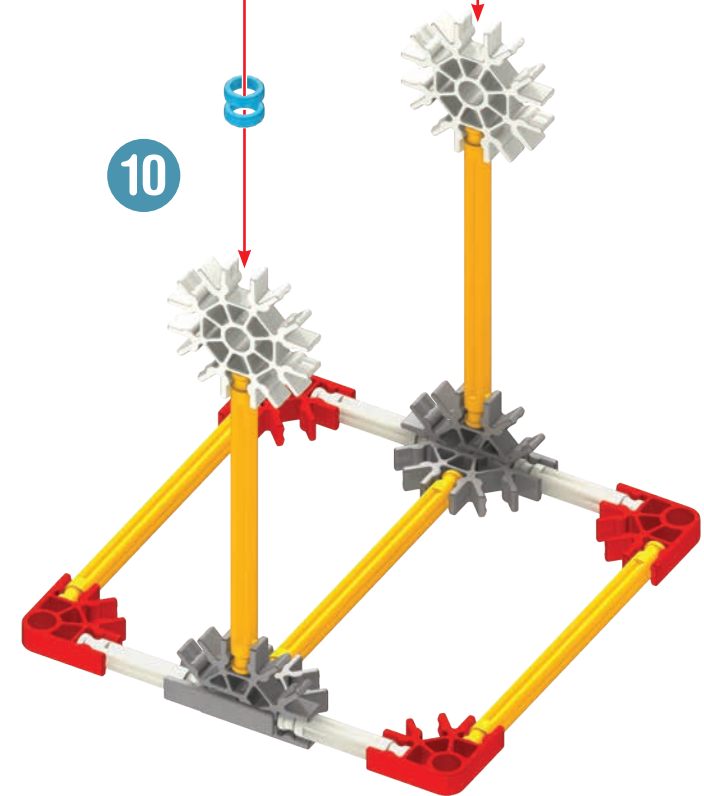

10

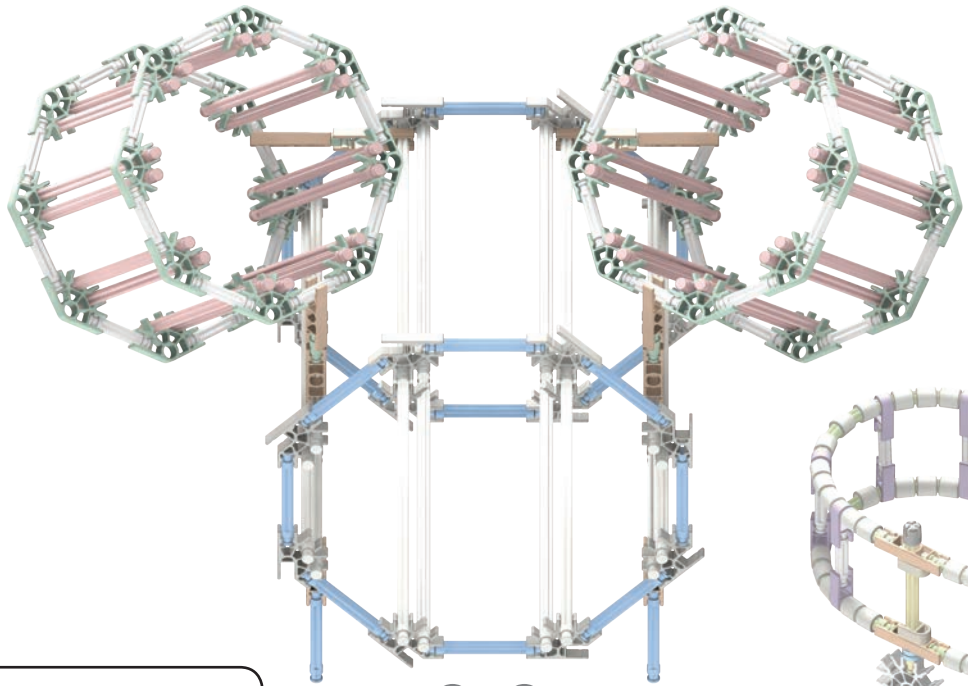

1 - 6

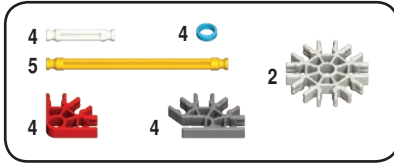

11

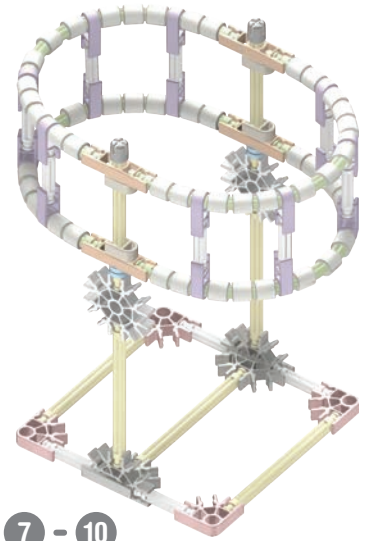

7 - 10

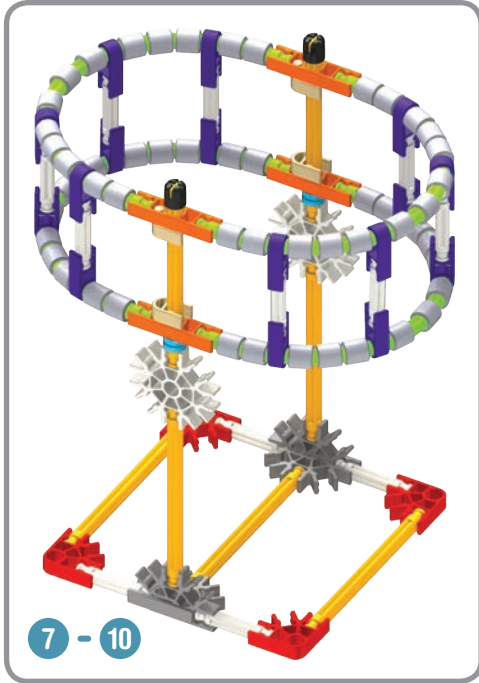

7 - 10

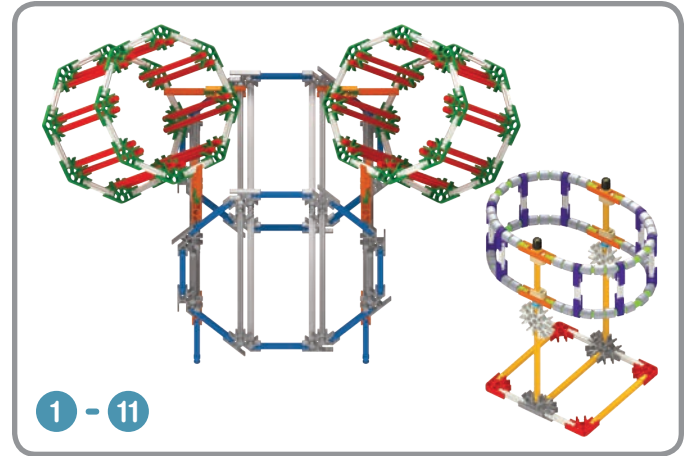

1 - 11

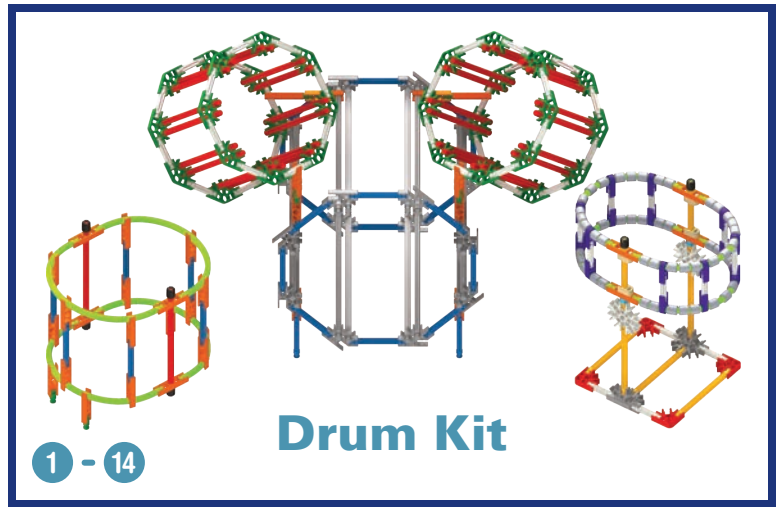
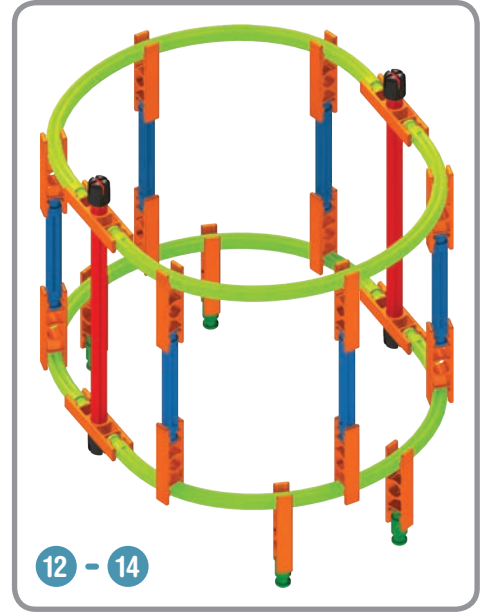
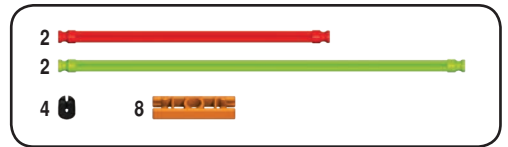
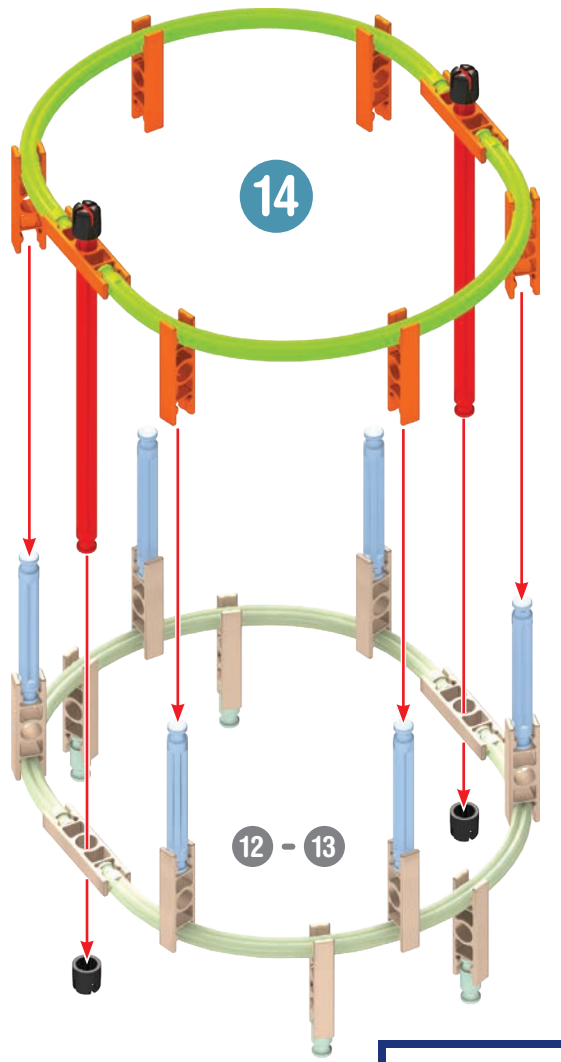
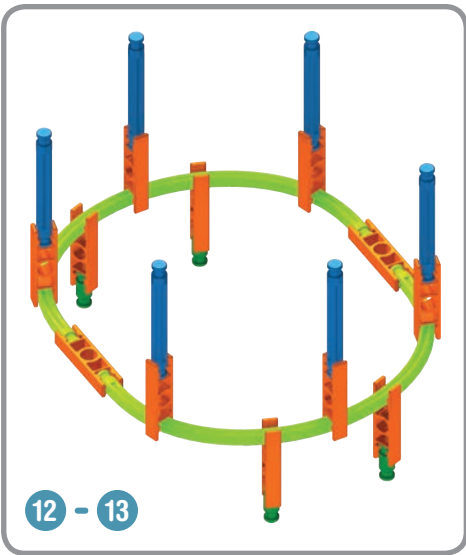
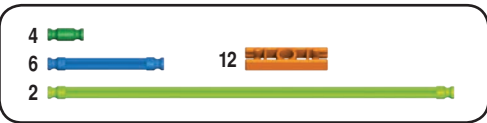
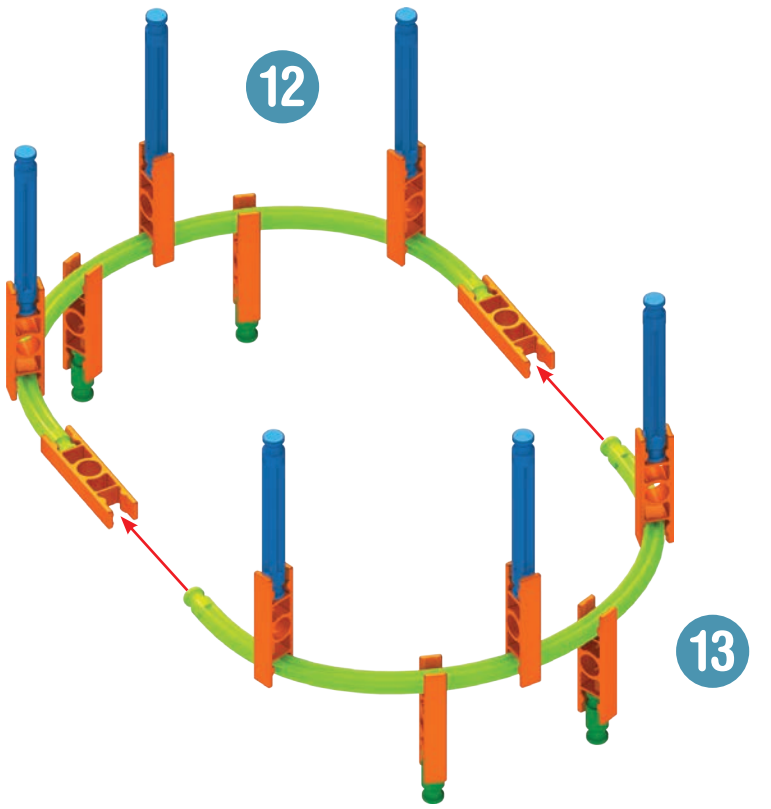

Flick Cannon

- 16
- 4
- 1
- 4
- 4
- 5

1

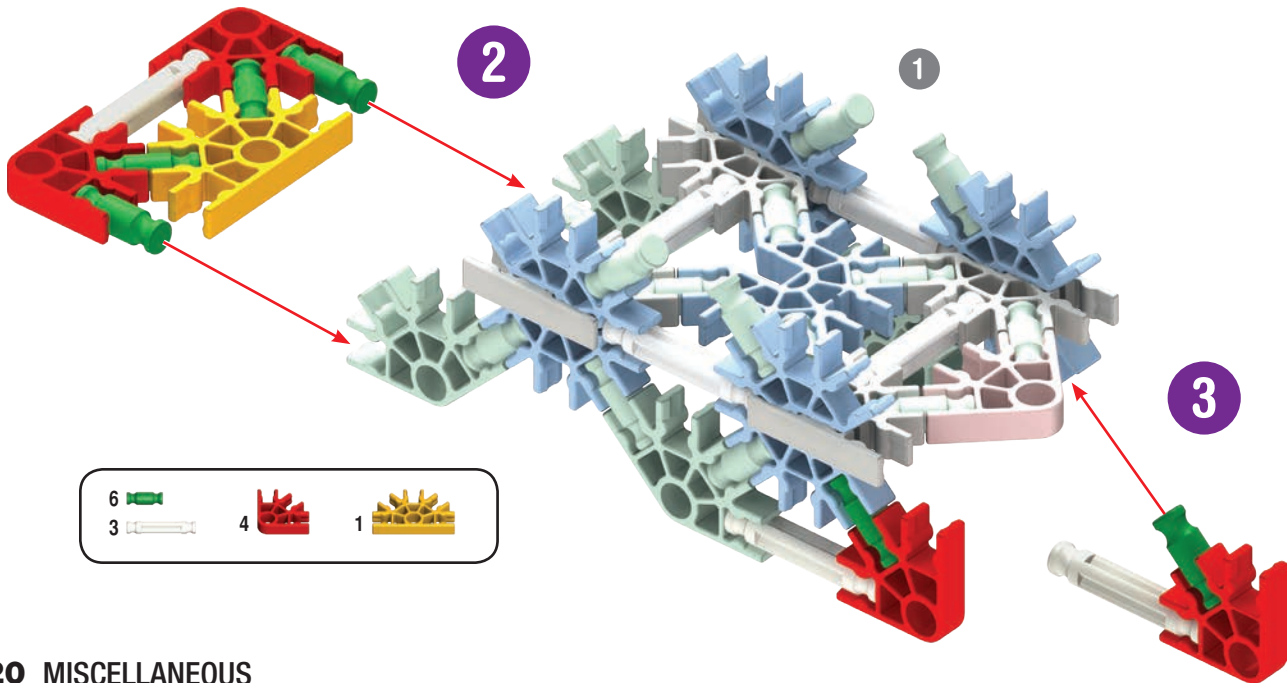
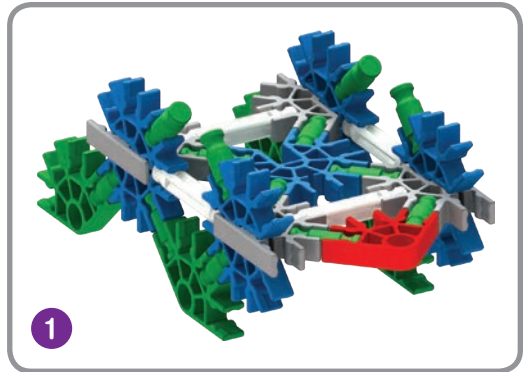
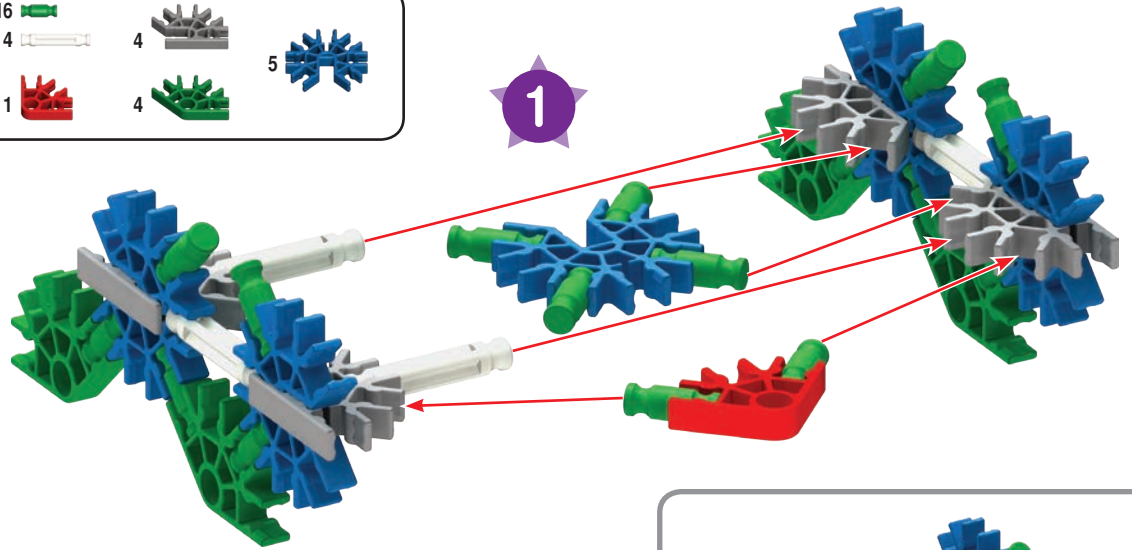

- 6
- 3
- 4
- 1

3

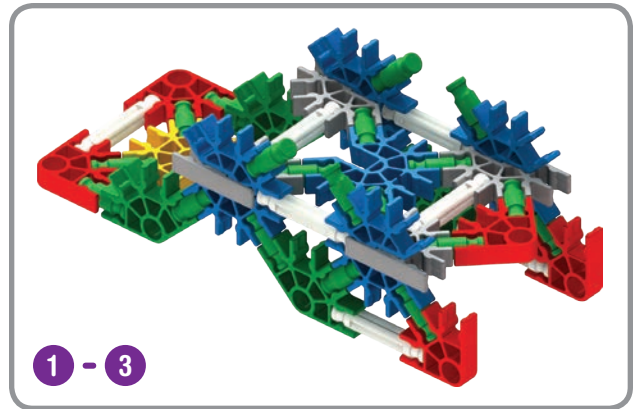

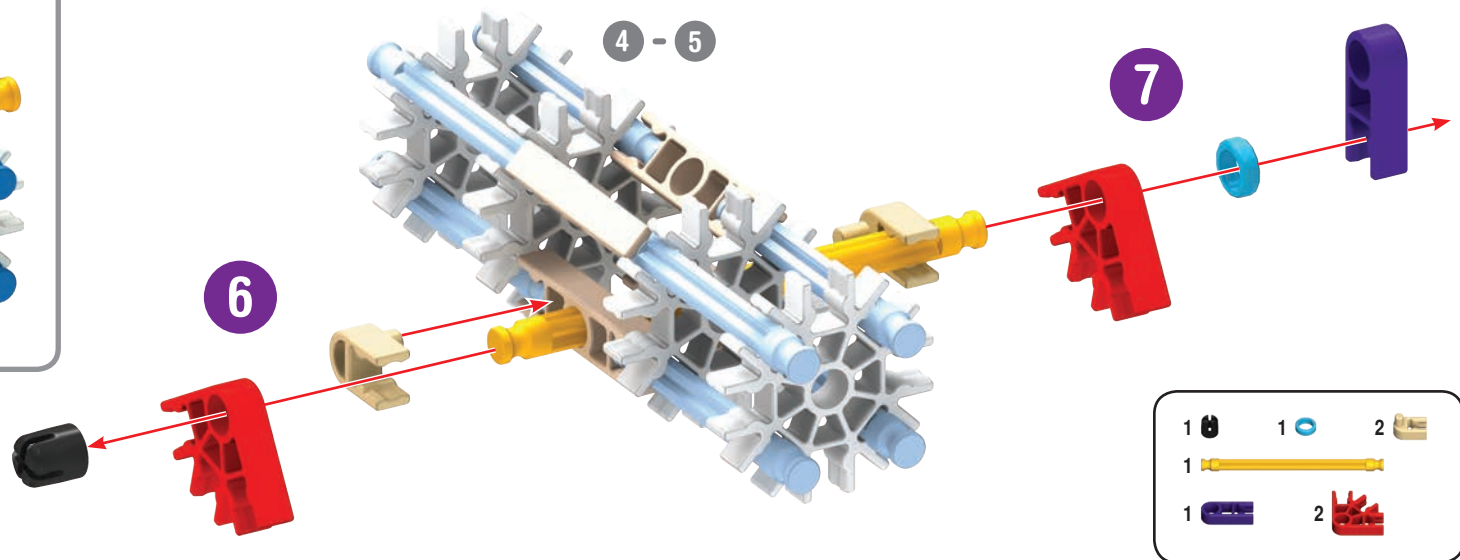
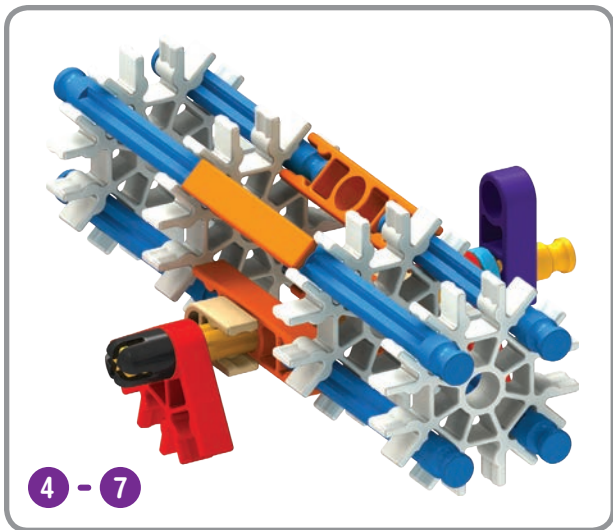
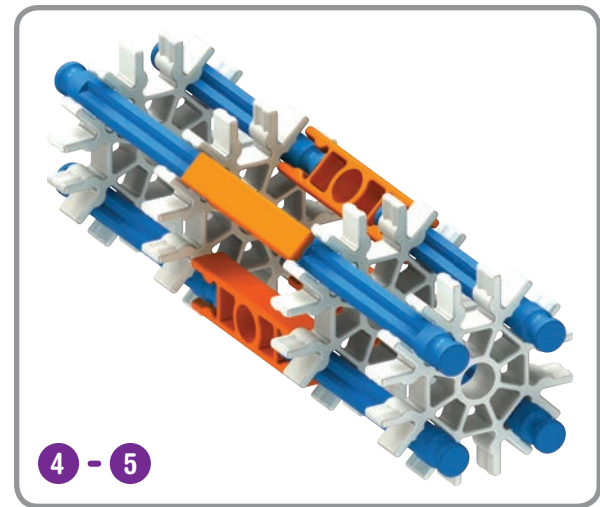
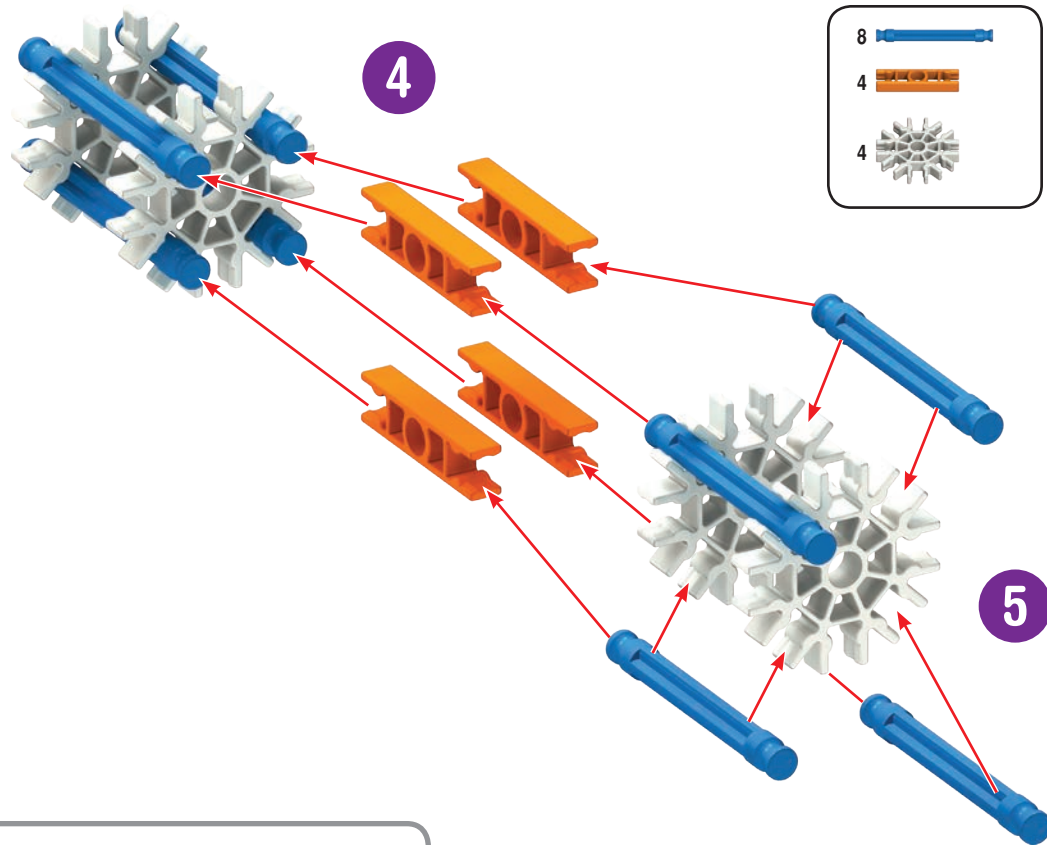

1 - 3

8

4 - 7

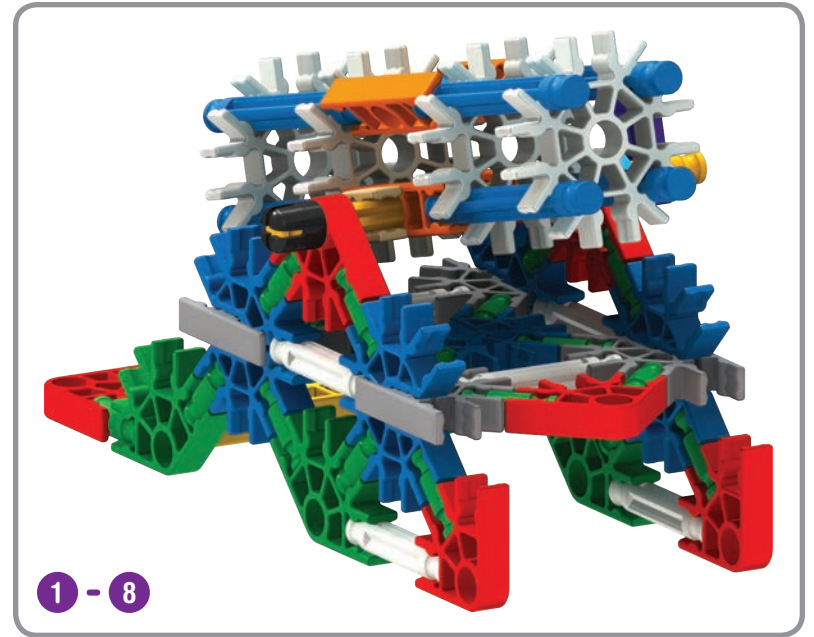
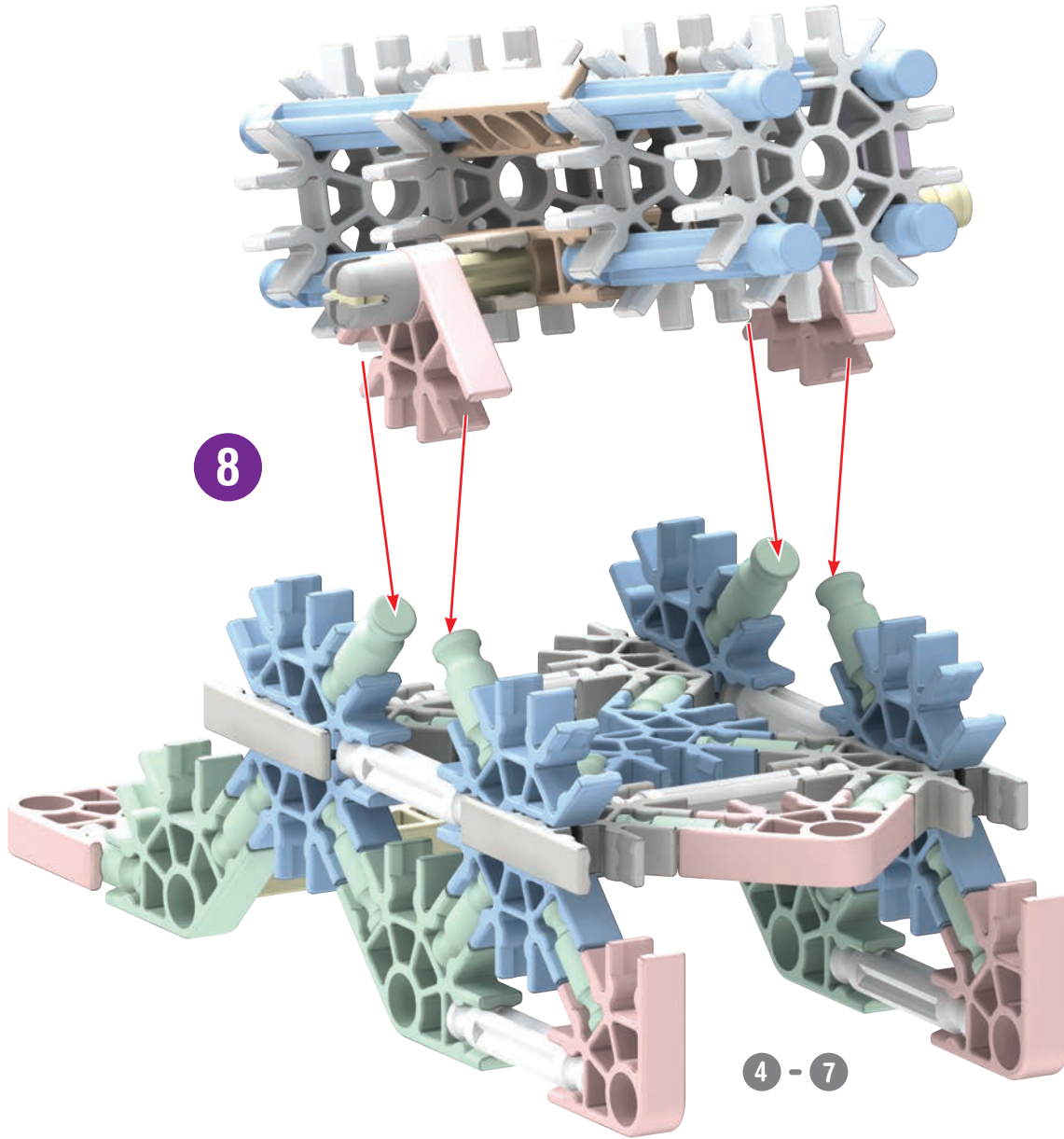

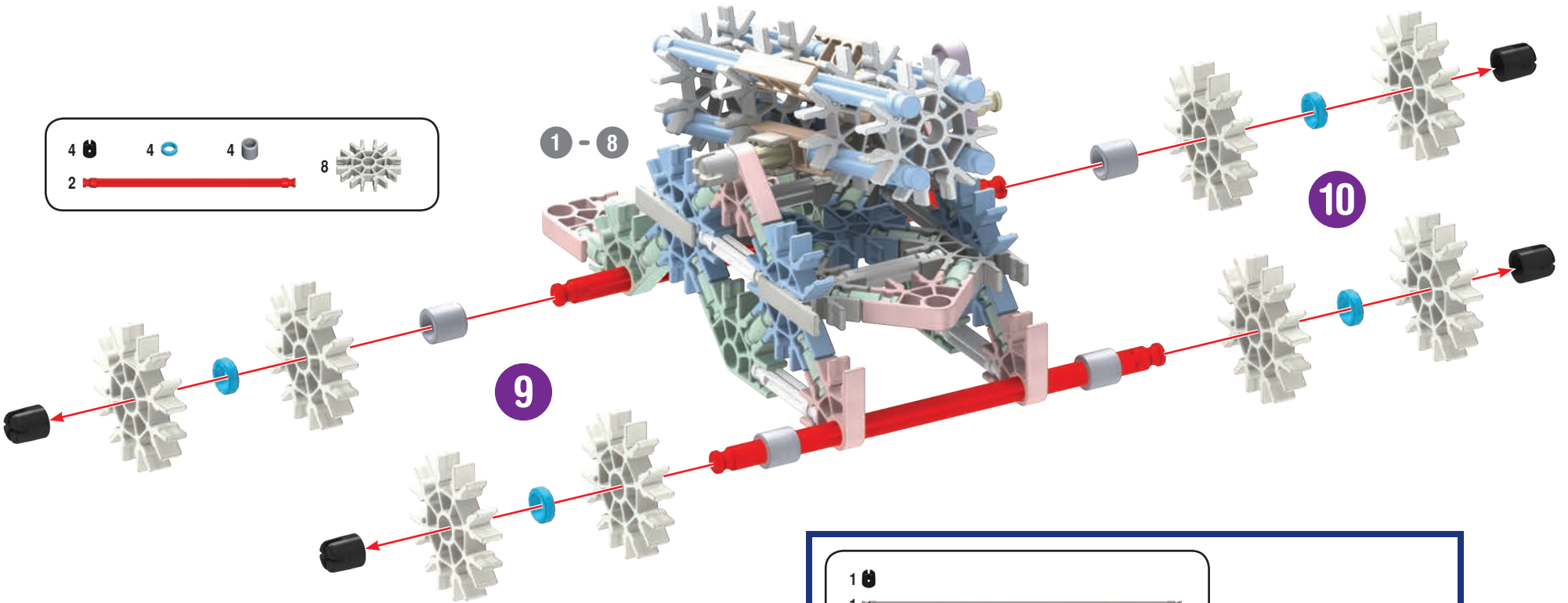
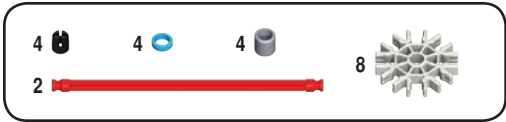

Flick Cannon

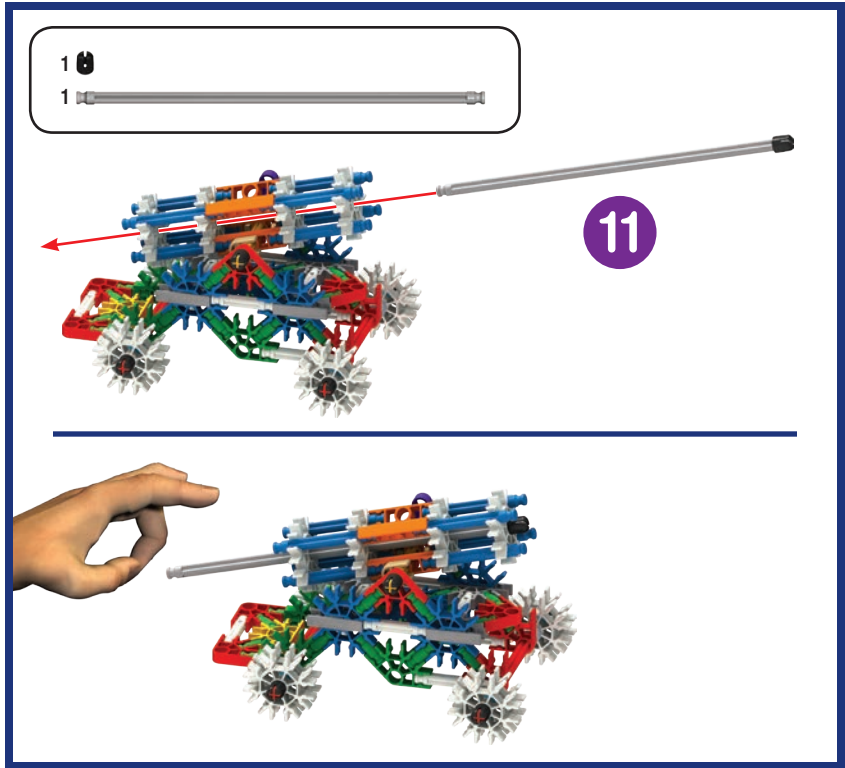
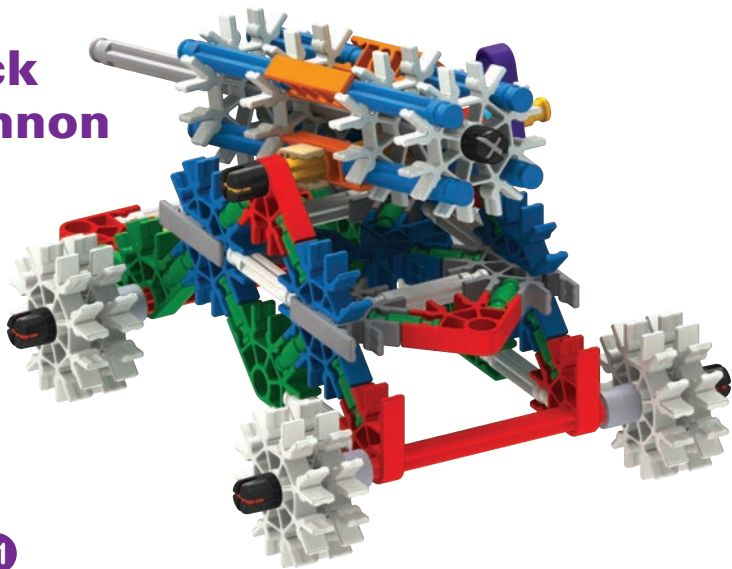

Gravitron

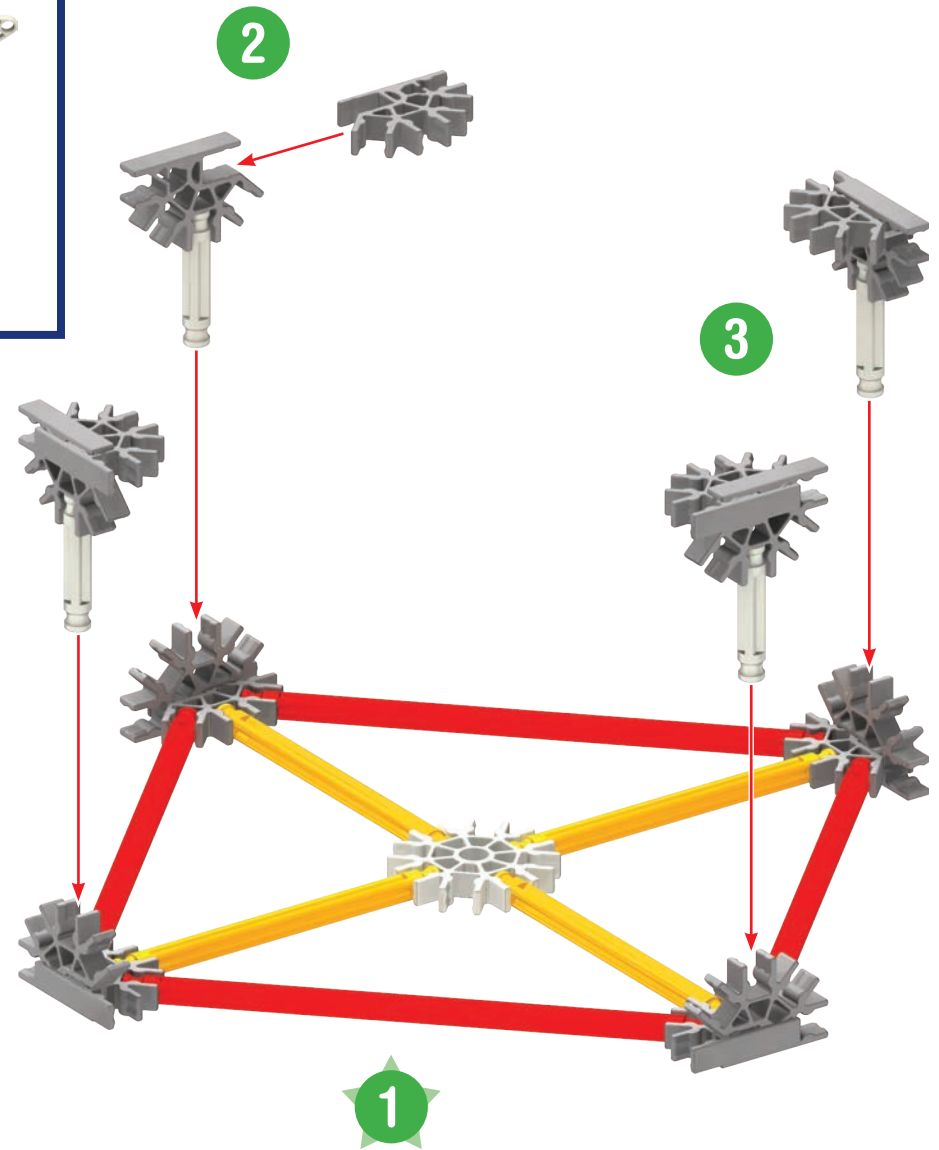
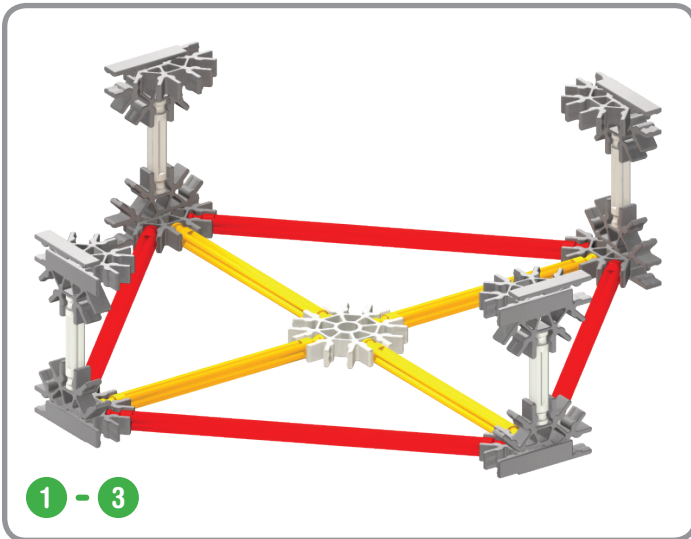
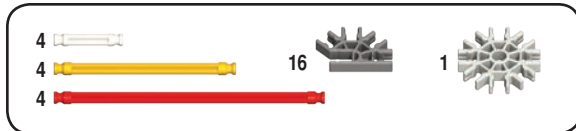
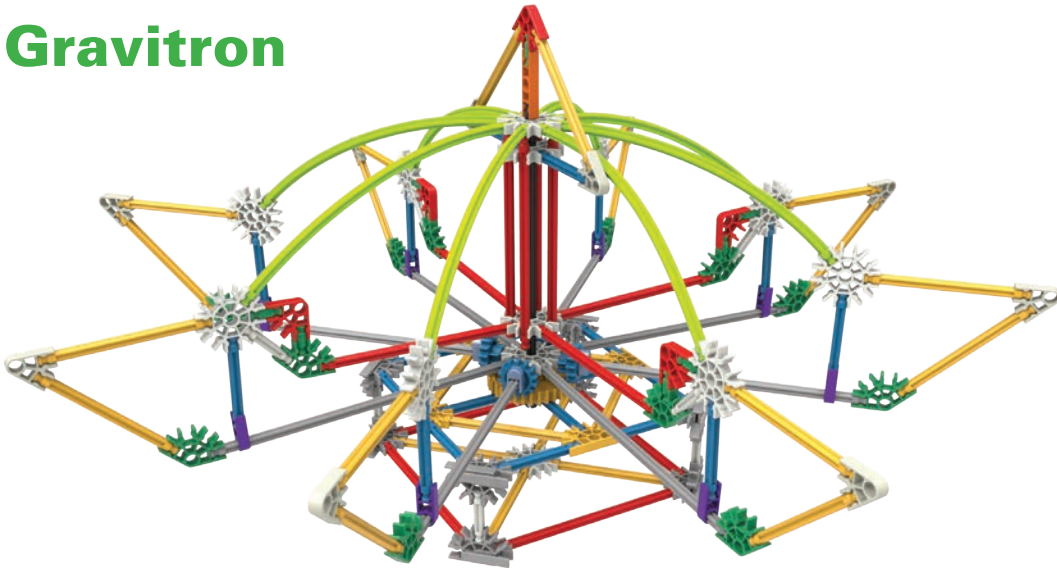

4

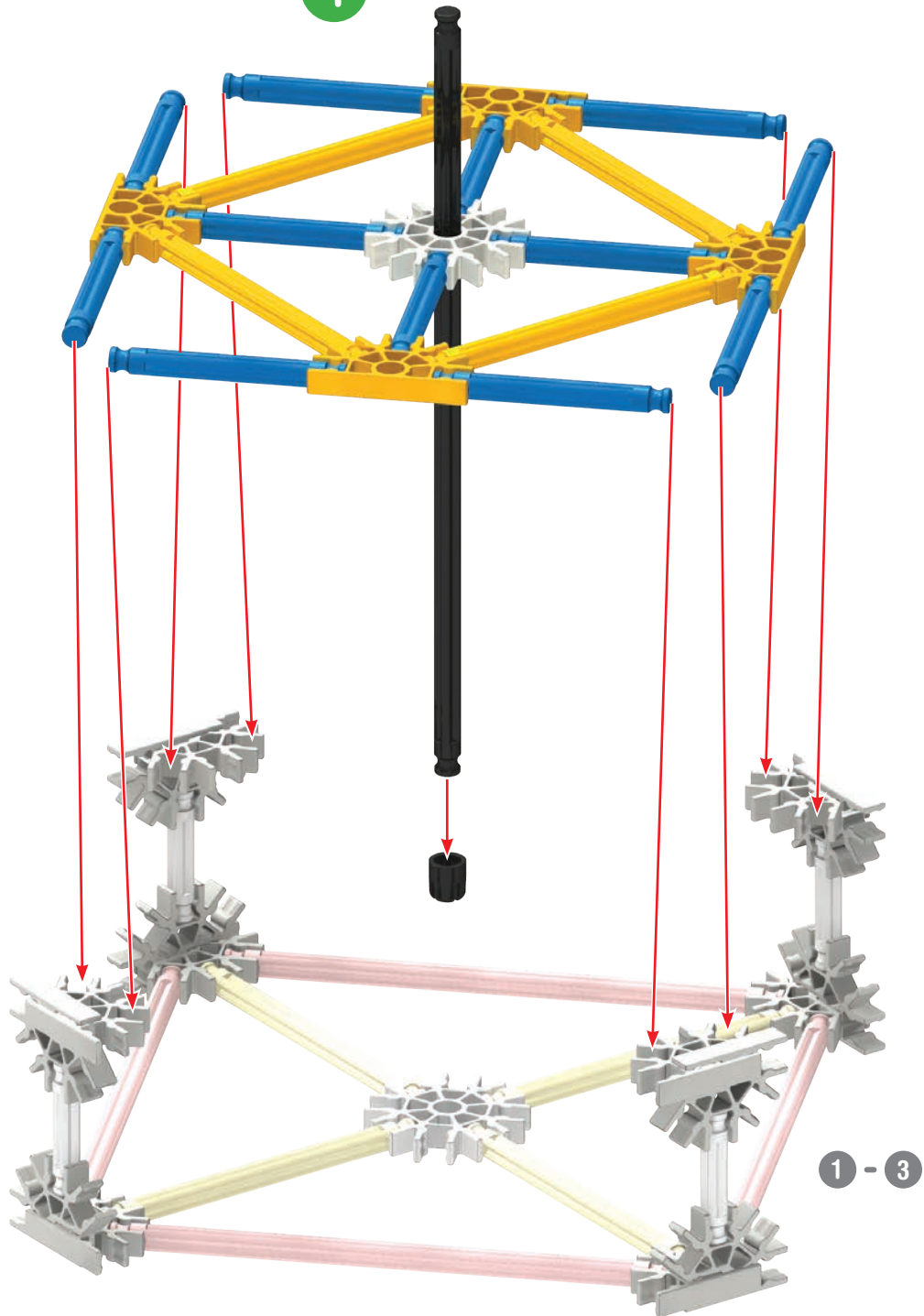

12		1		4		1	
4							
1							

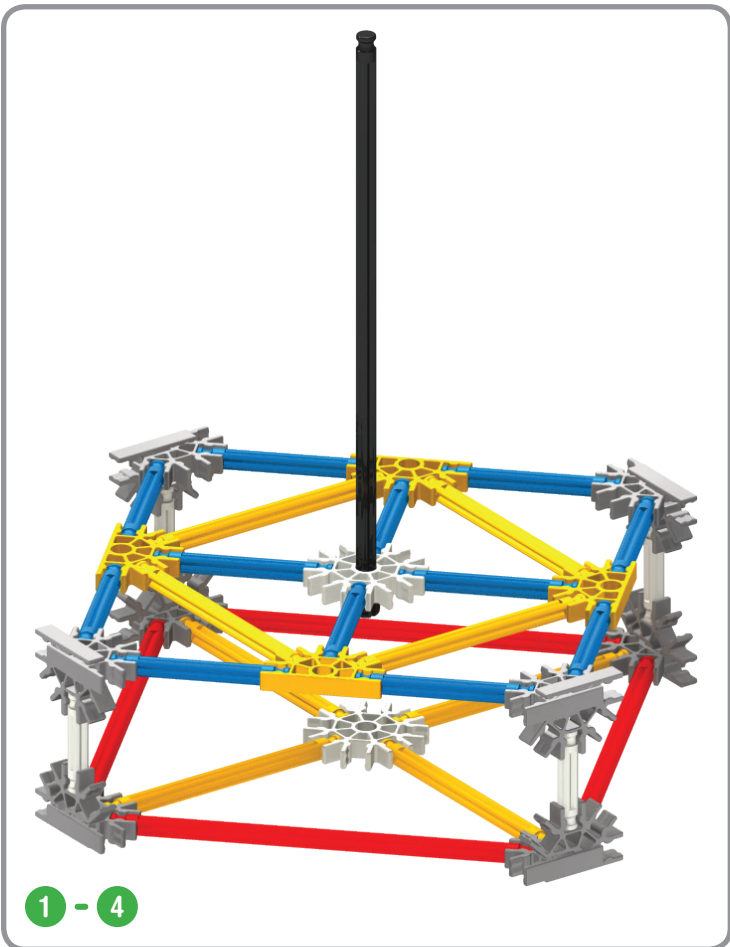

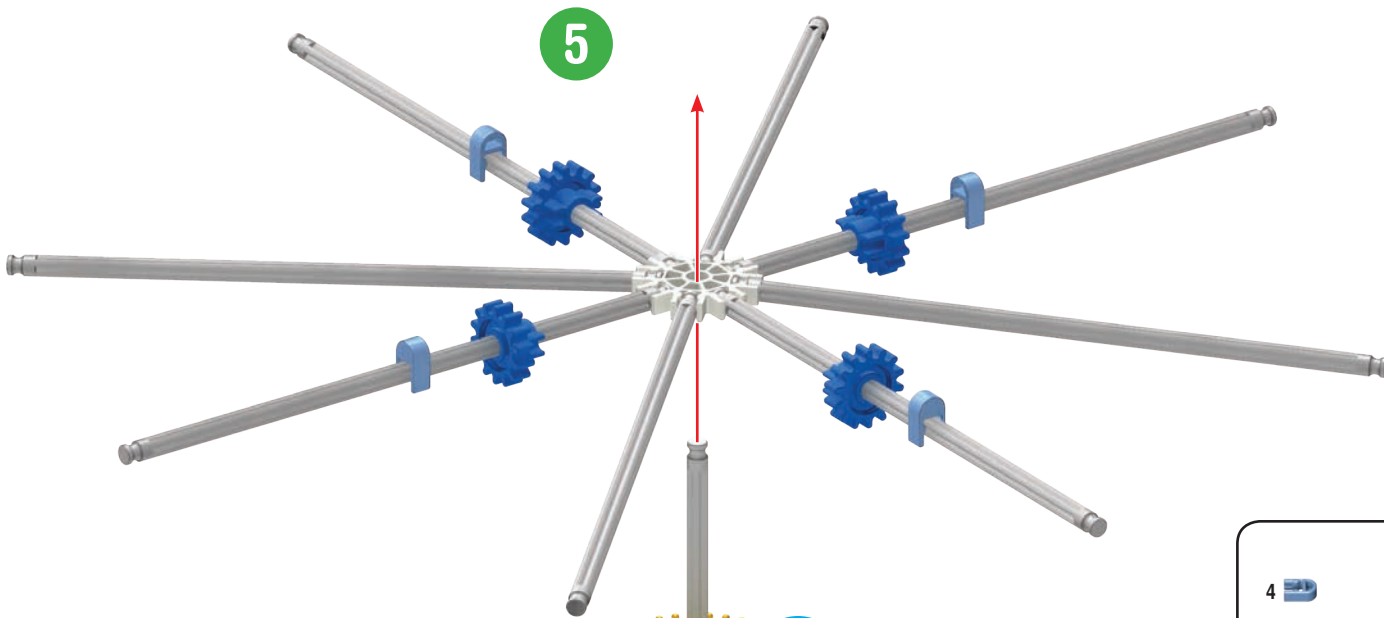

5

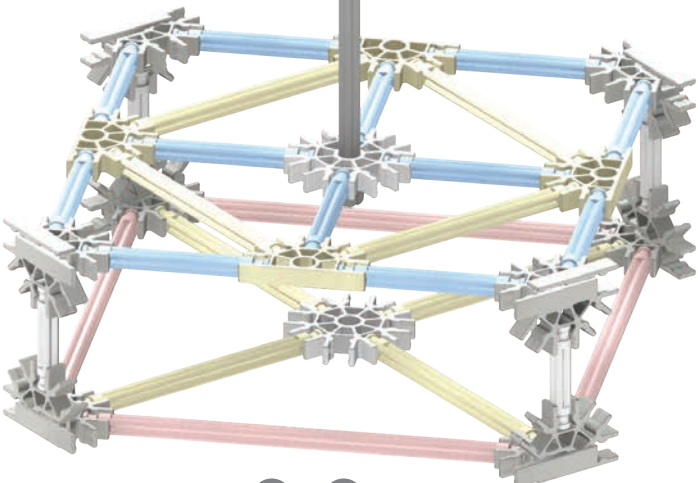
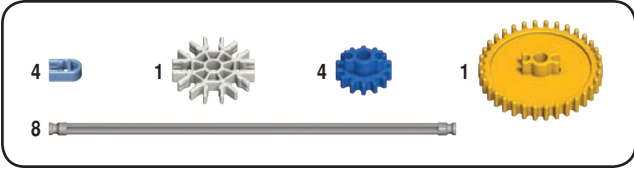

1 - 4

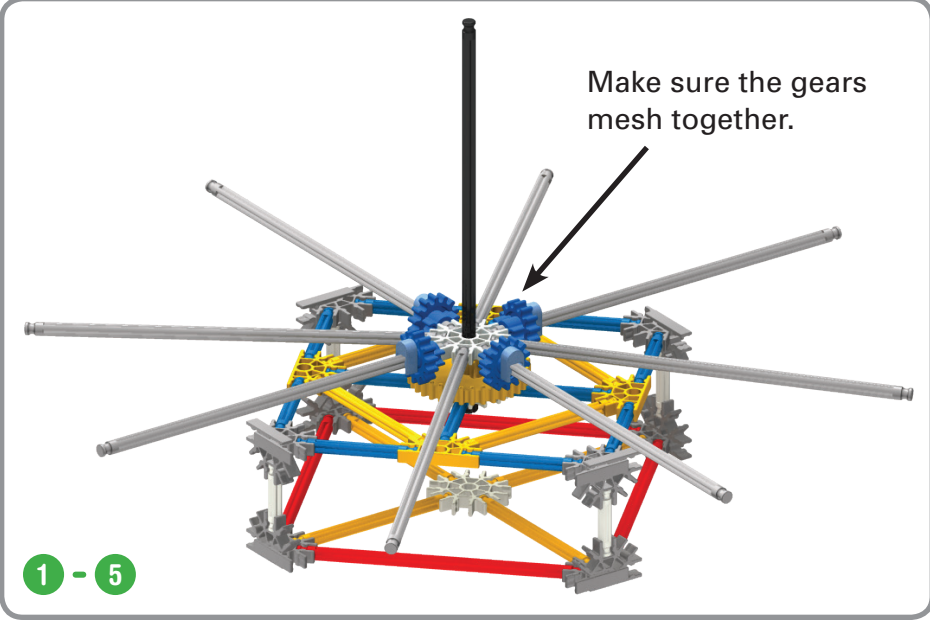

1 - 5

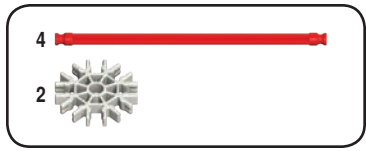

6

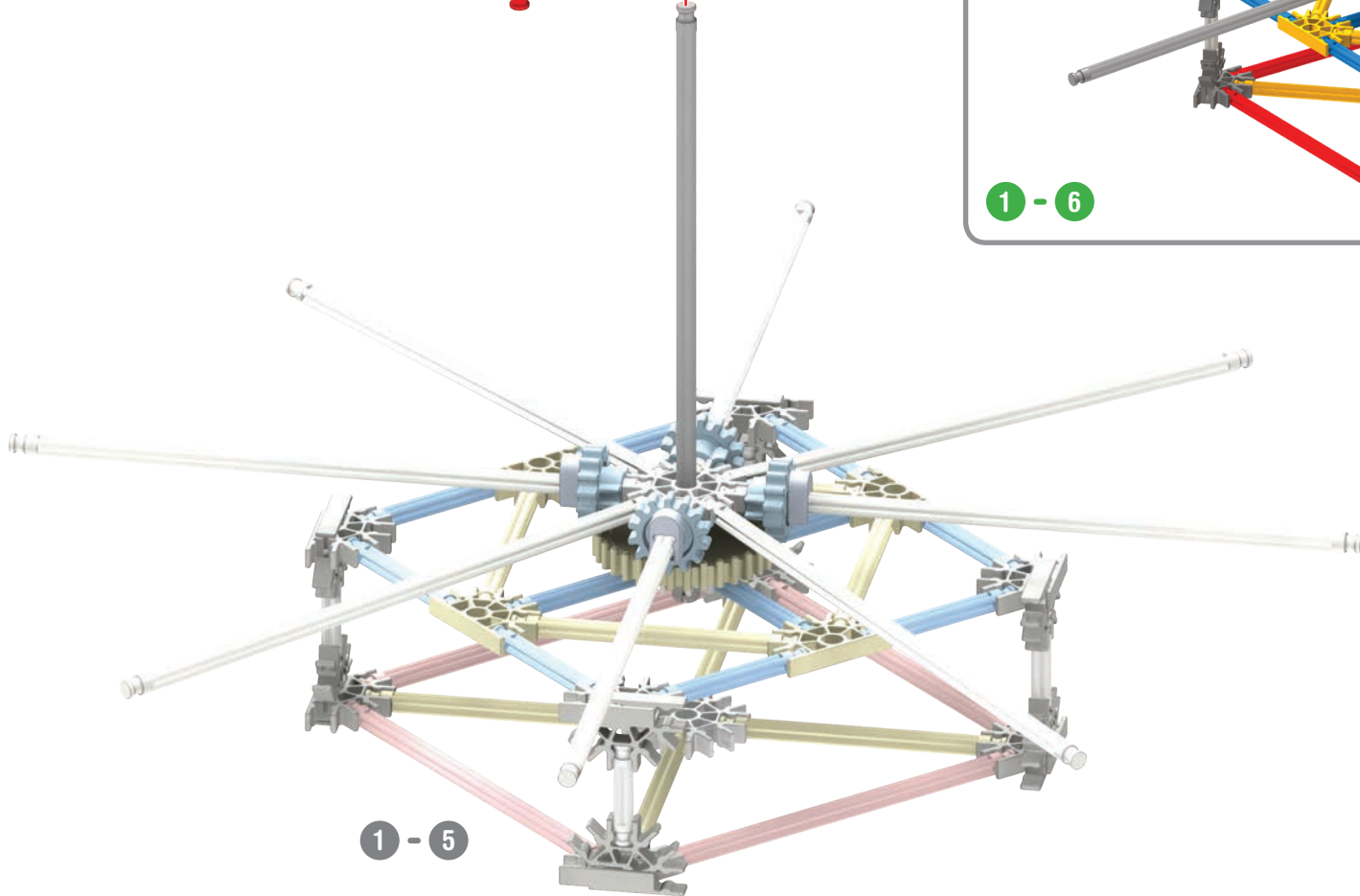
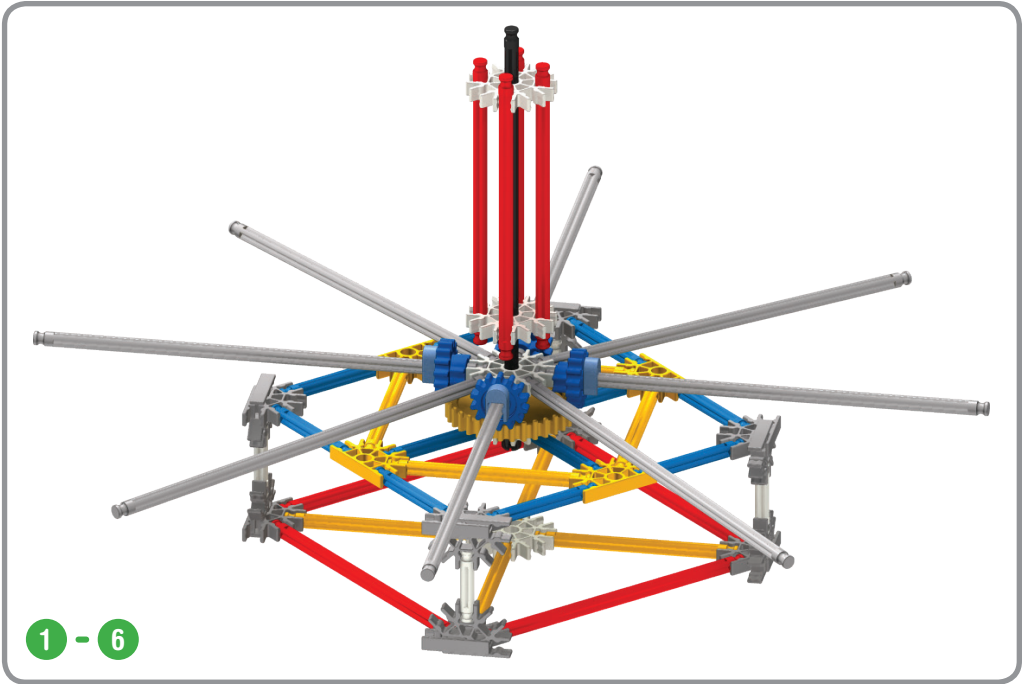
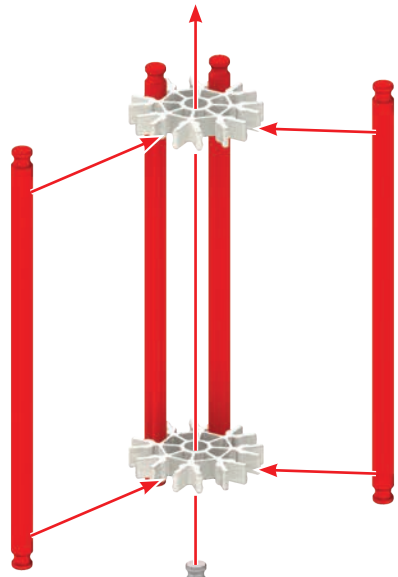

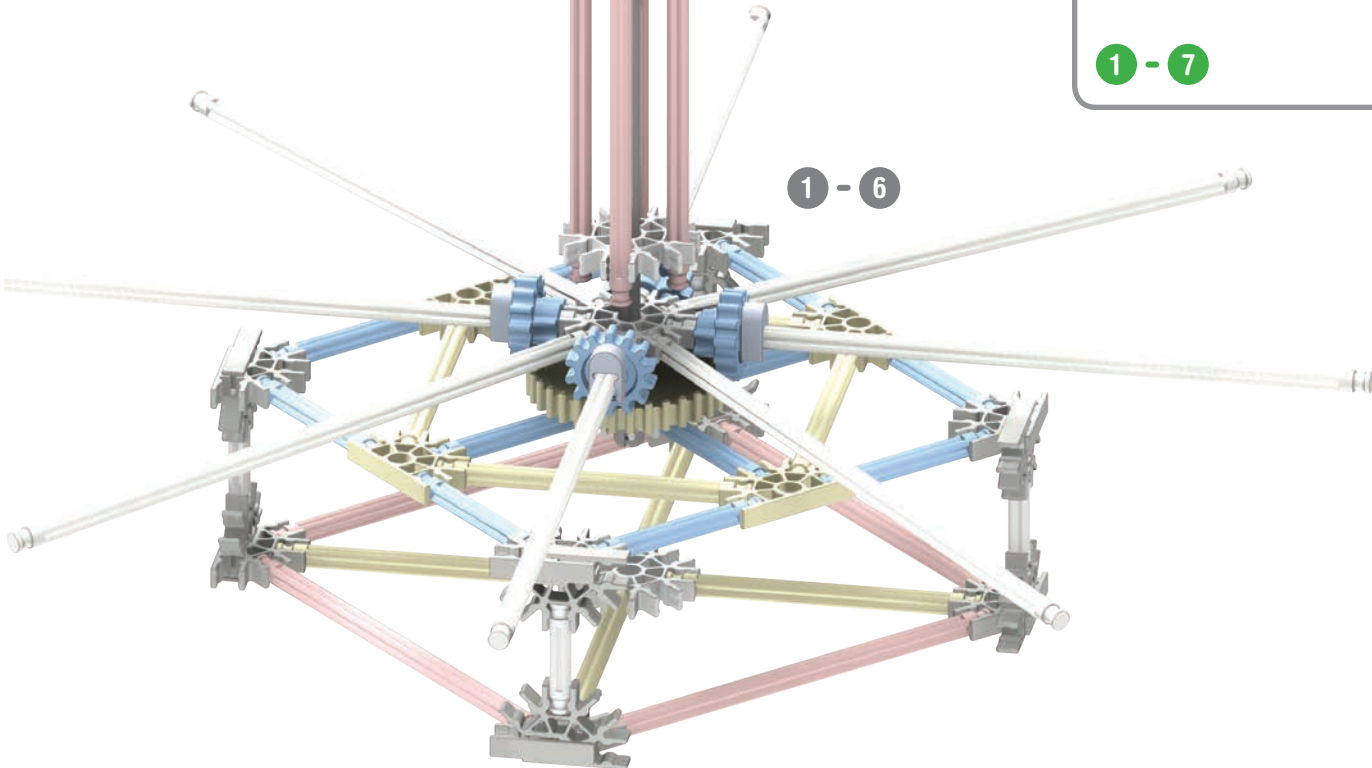
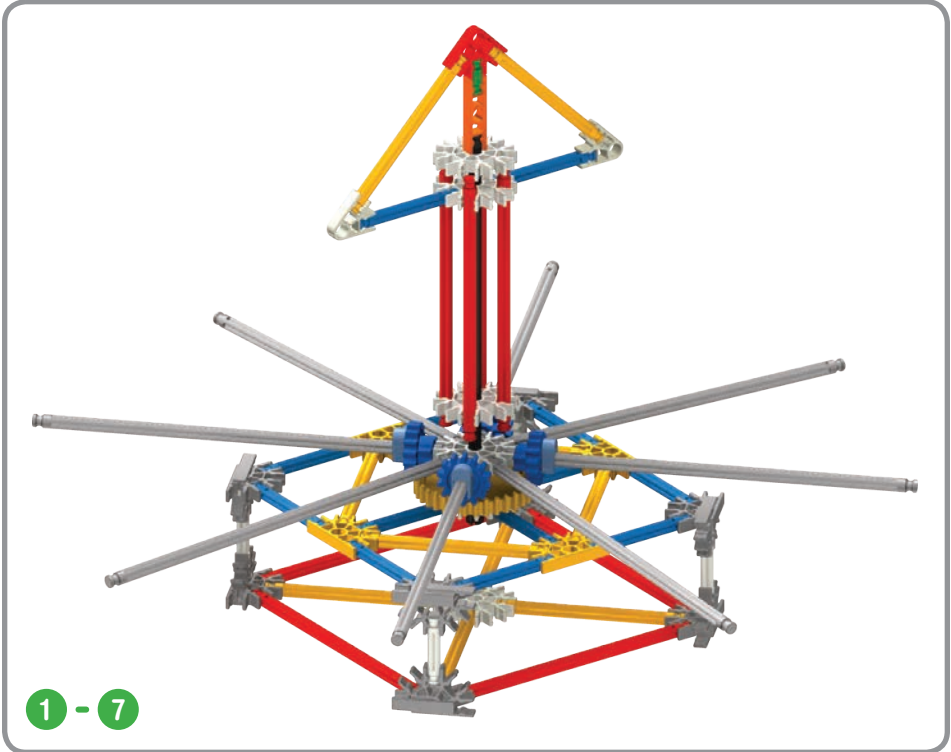
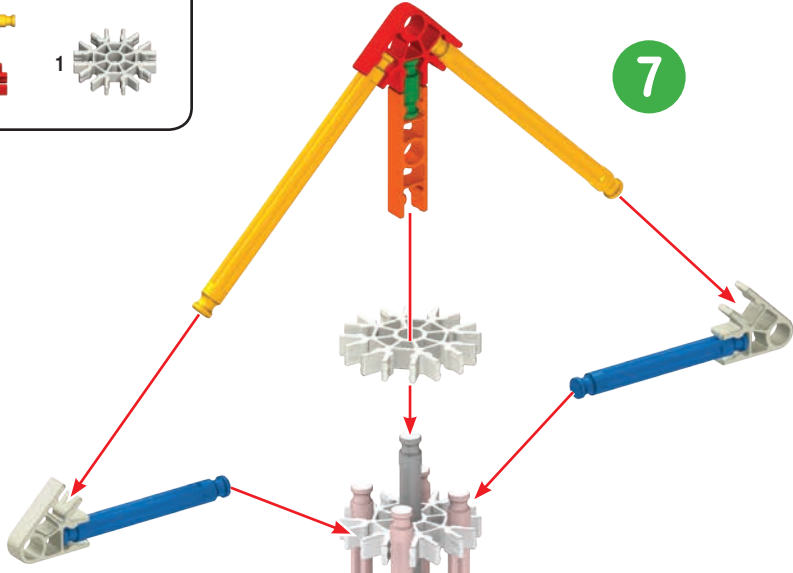
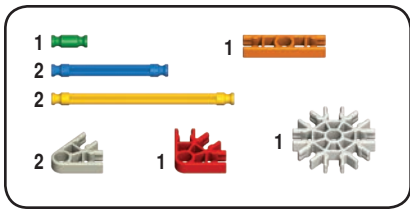

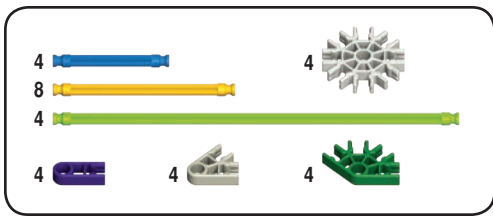

x4

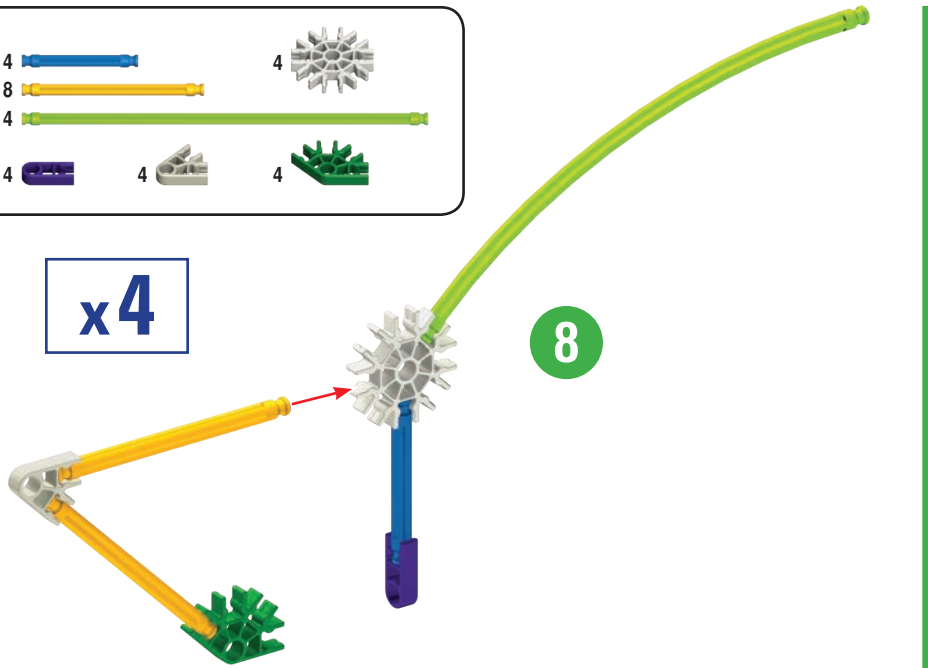

8

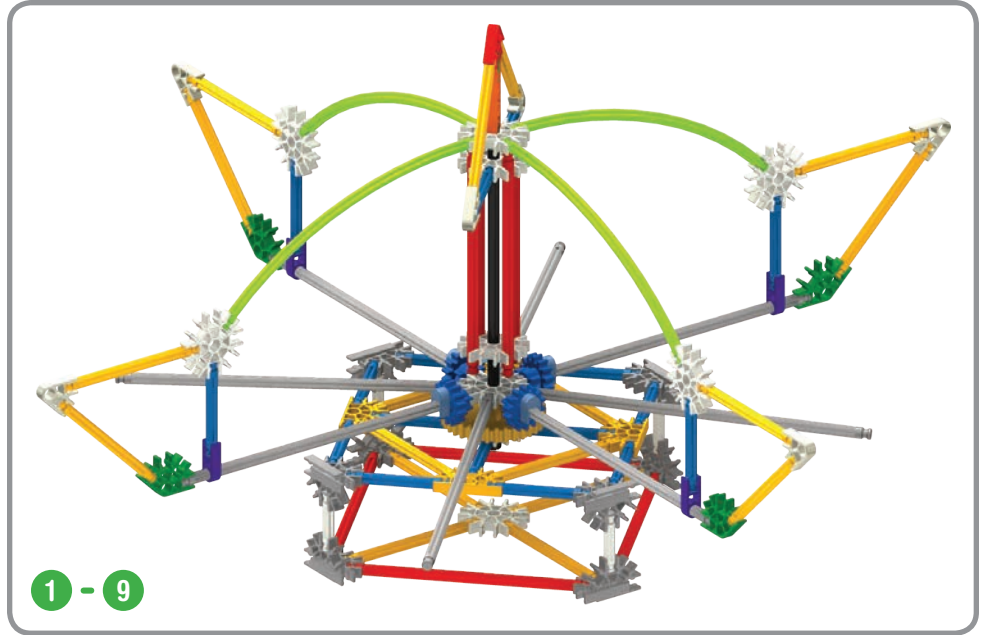

1 - 9

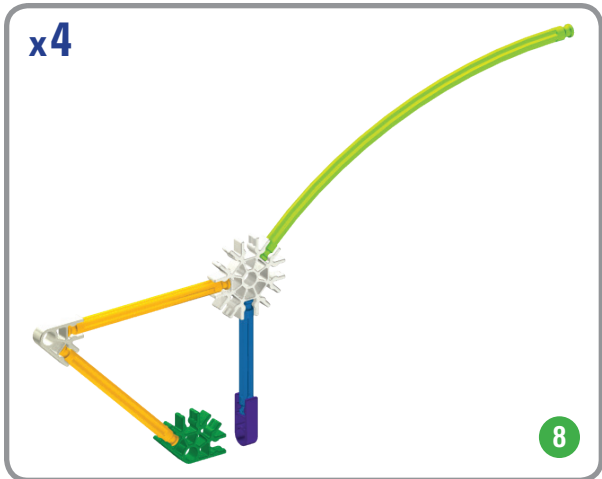

x4

8

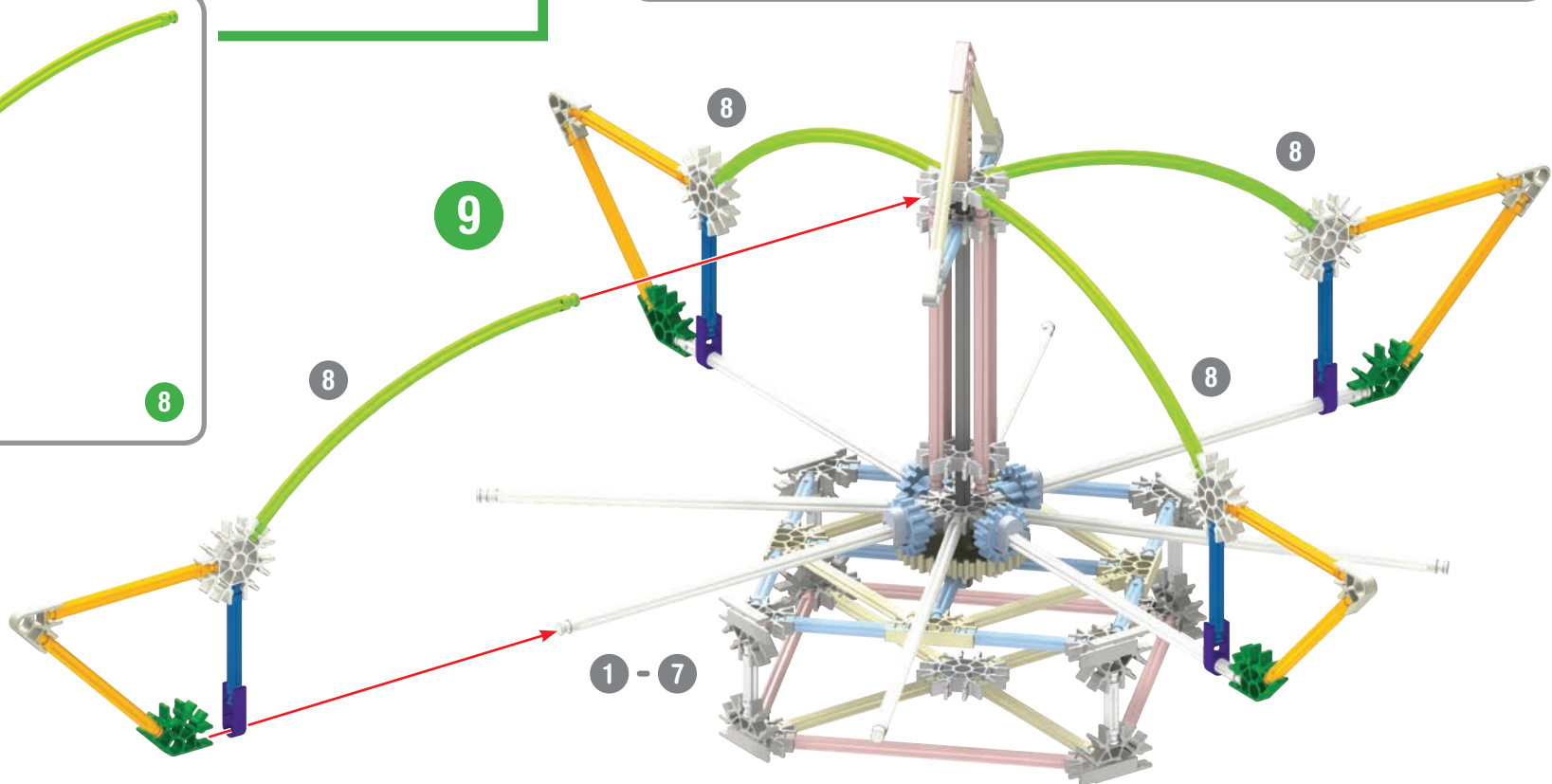

1 - 7

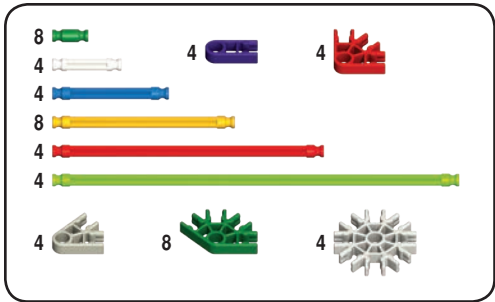

x4

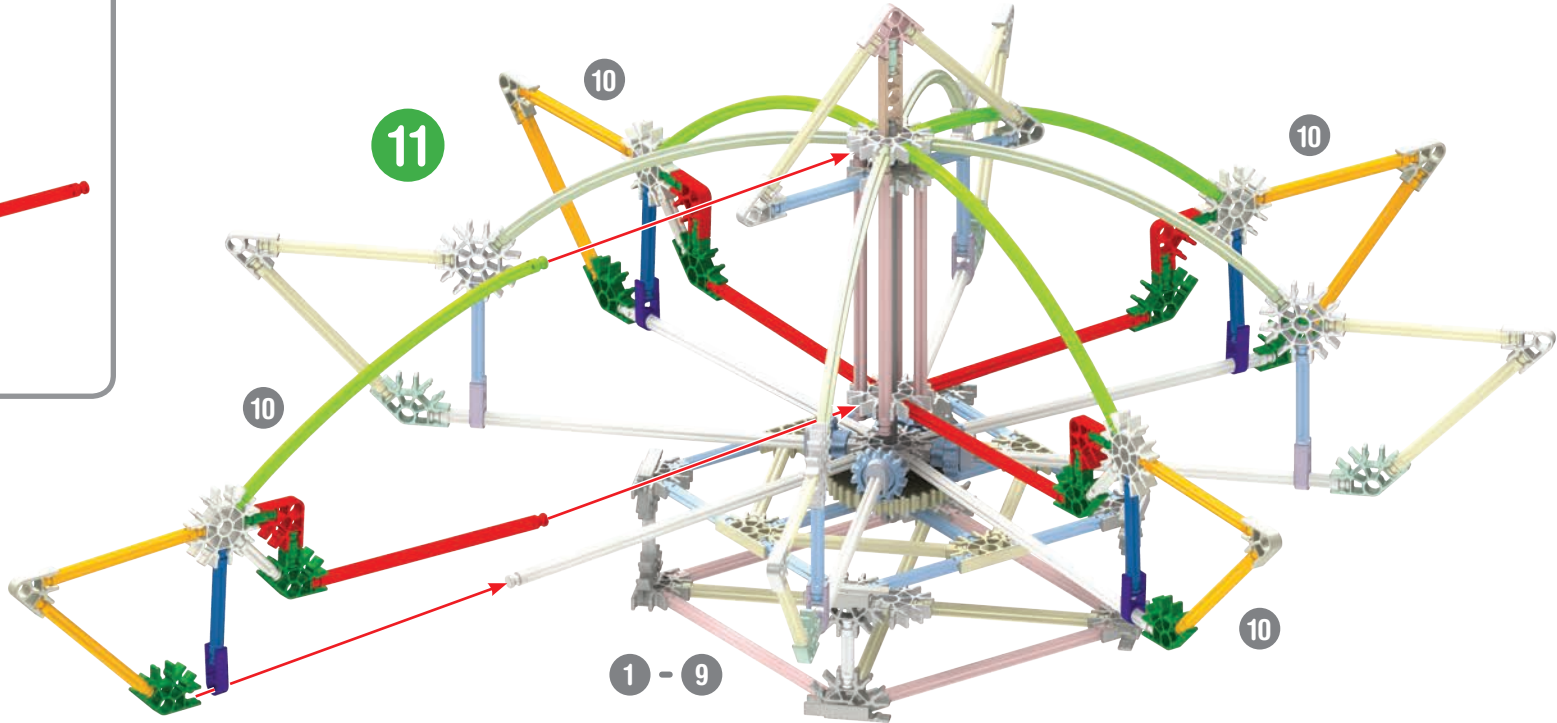
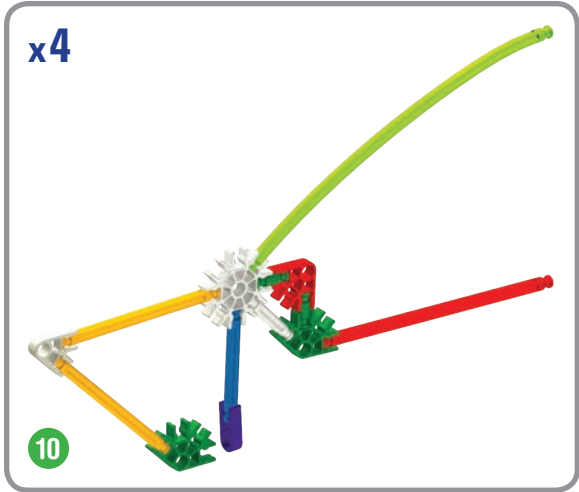
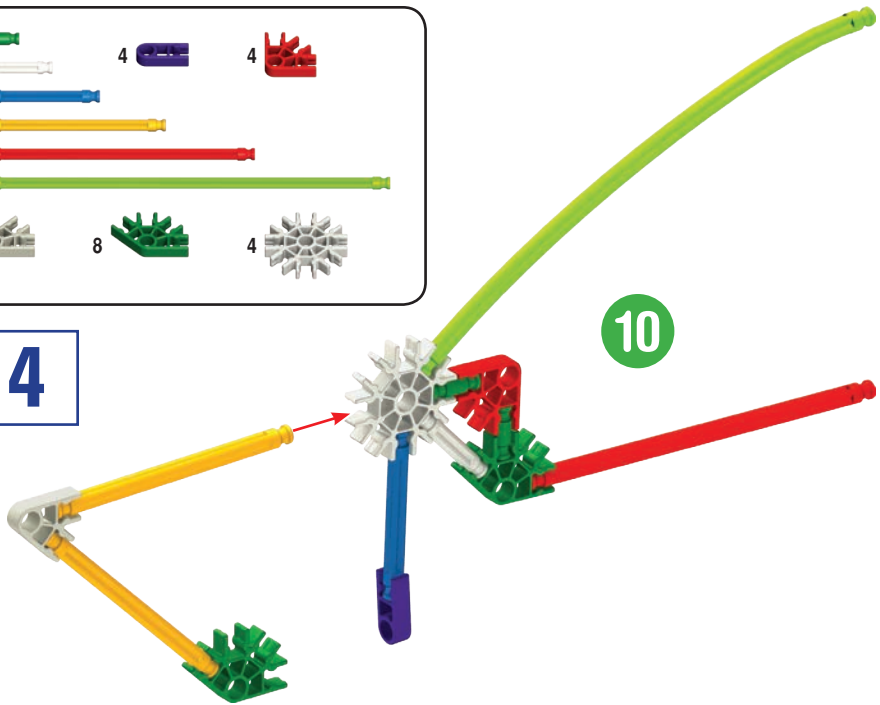

Guitar

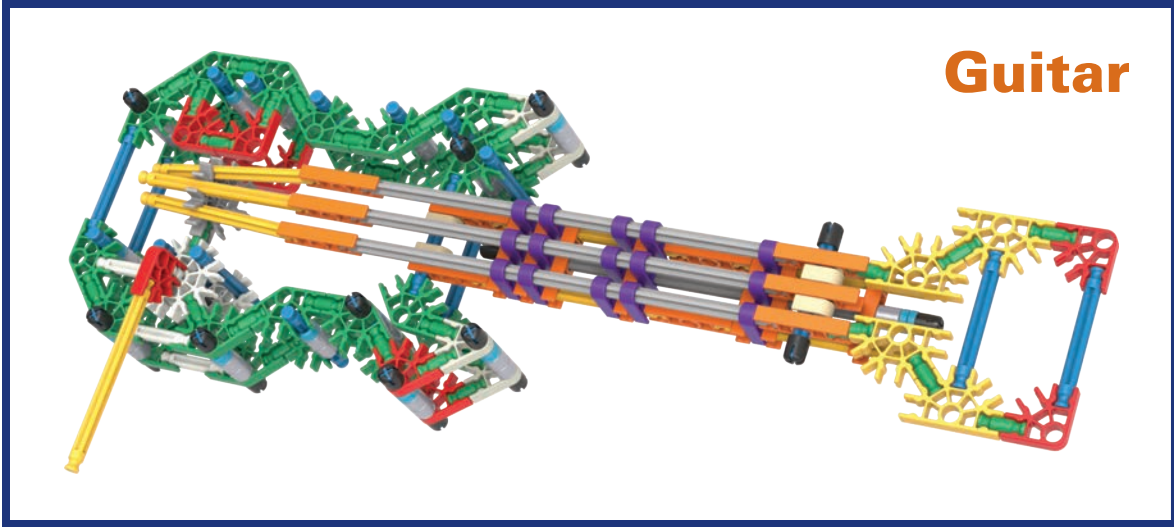

x2

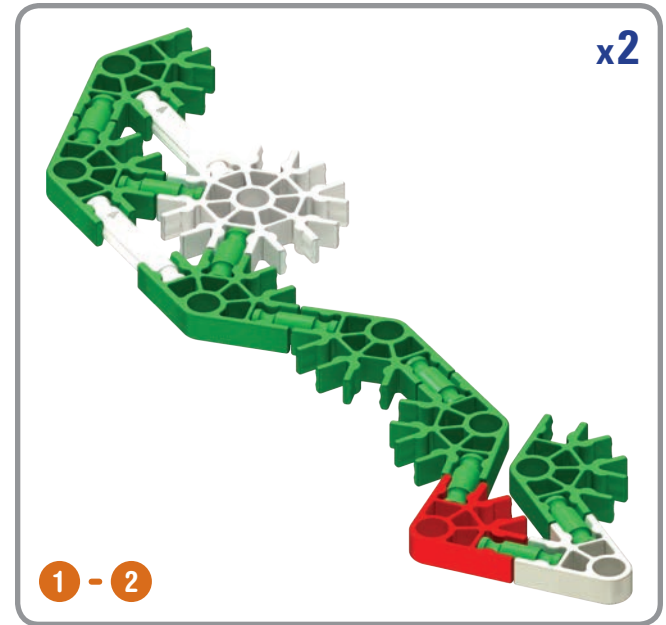
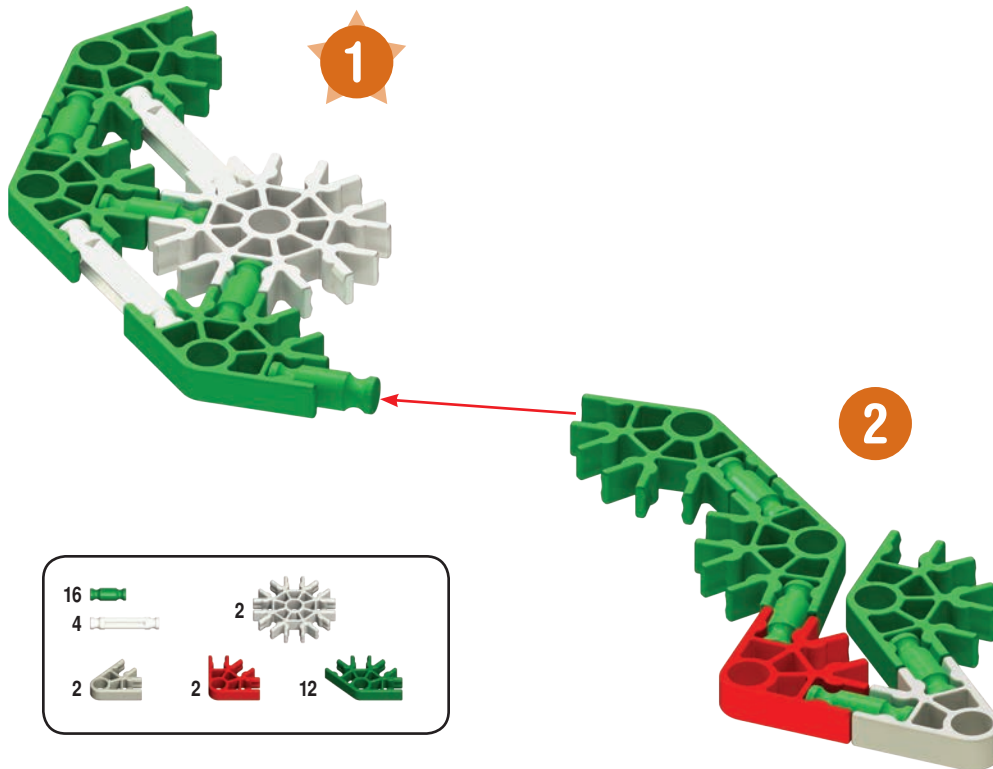

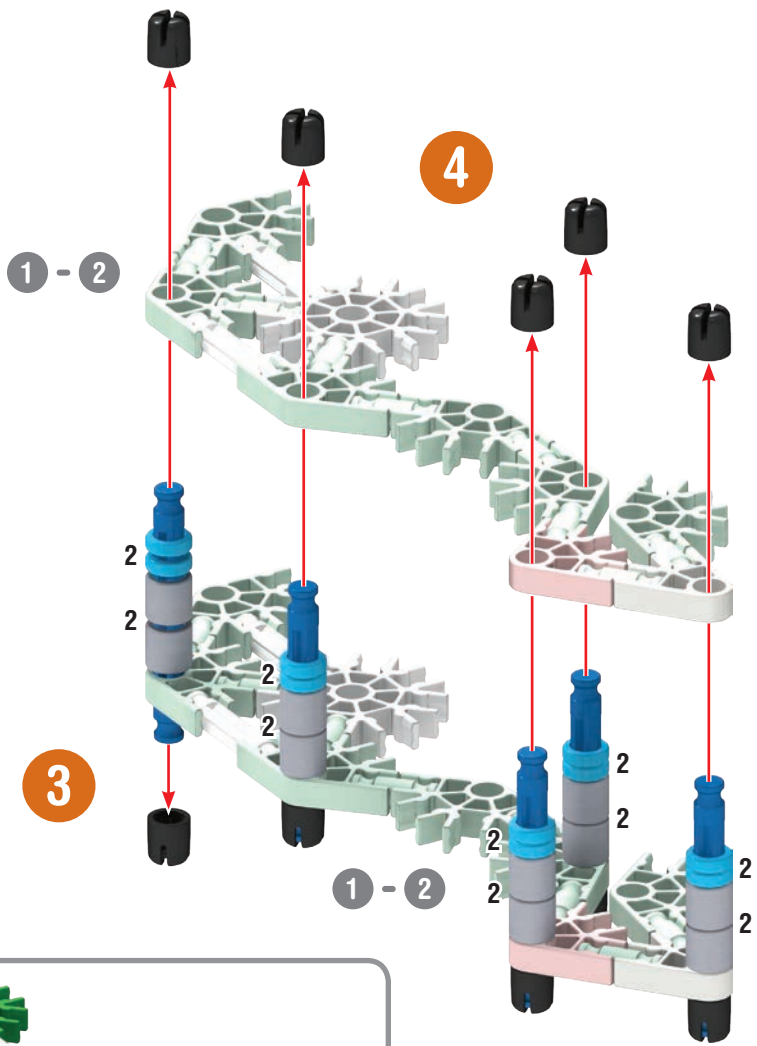

- | | | |
|----|----|----|
| 10 | 10 | 10 |
| 5 | | |



1 - 4

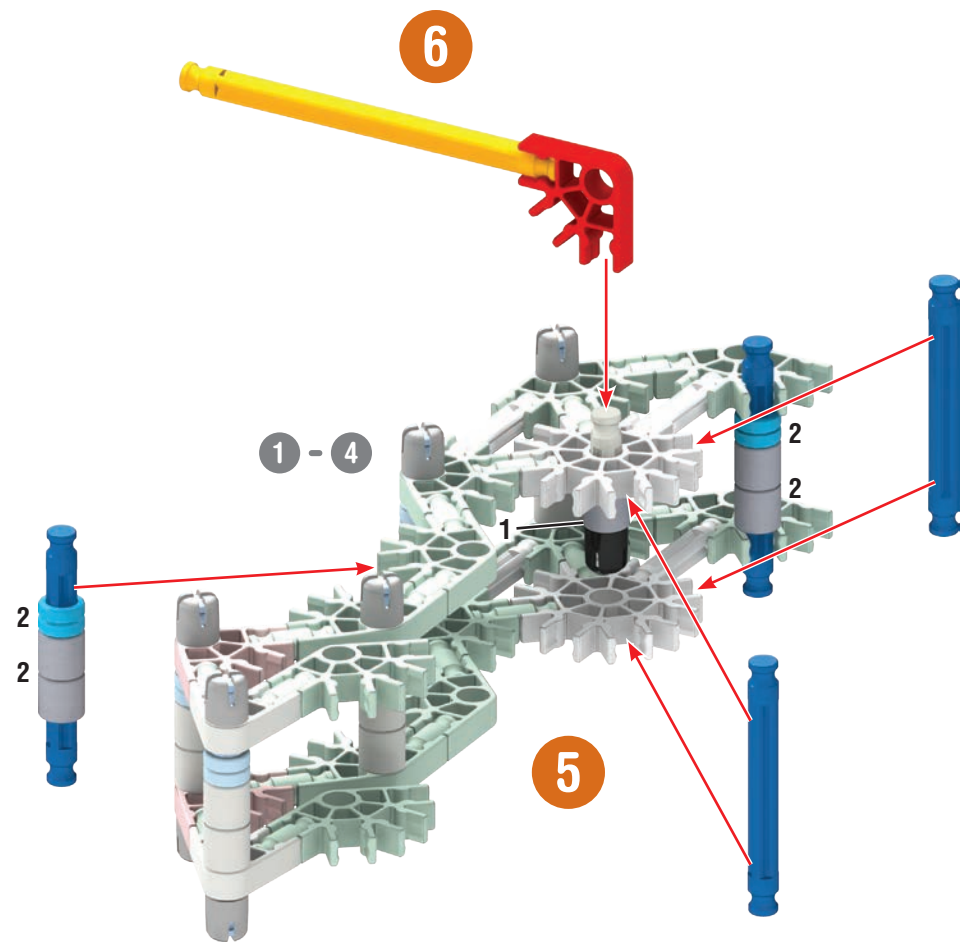





- | | | |
|---|---|---|
| 1 | | 1 |
| 4 | | |
| 1 | | |
| 1 | 4 | 5 |

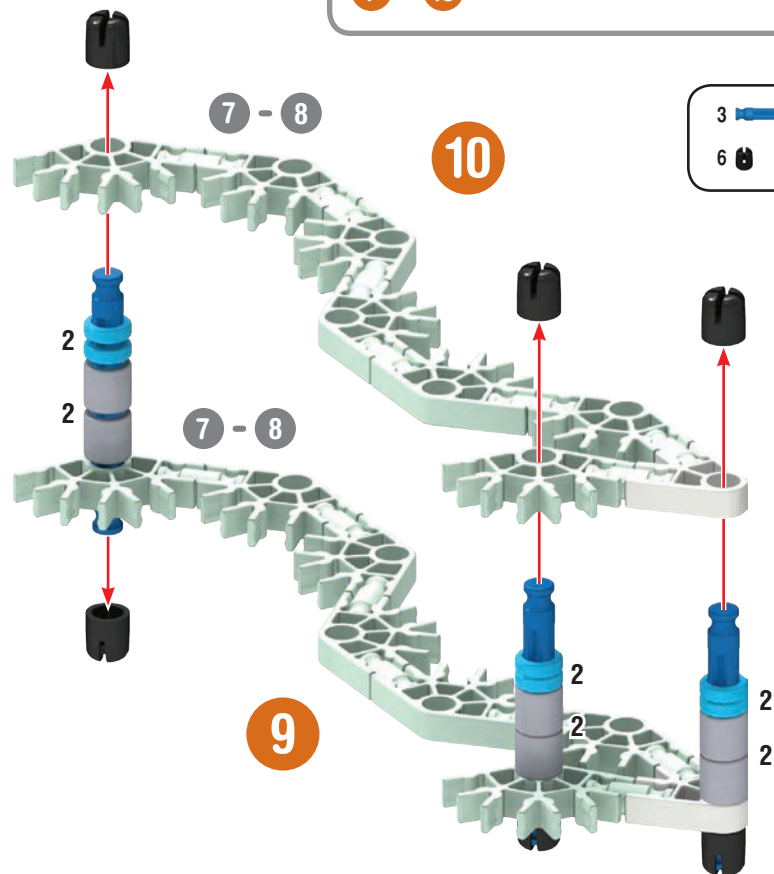
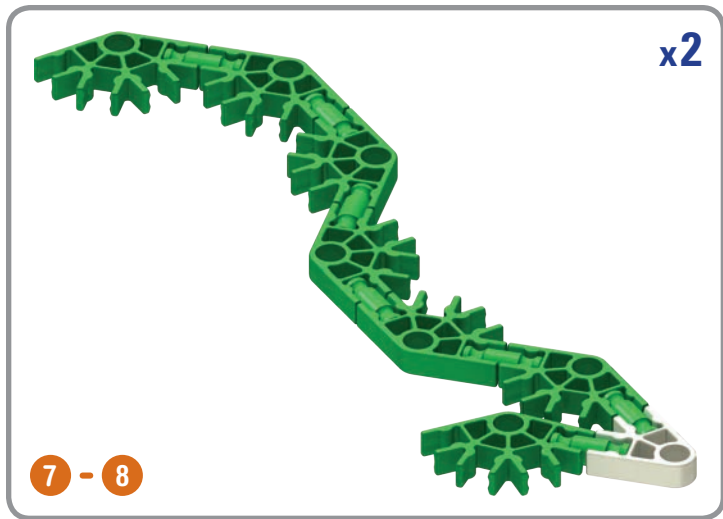
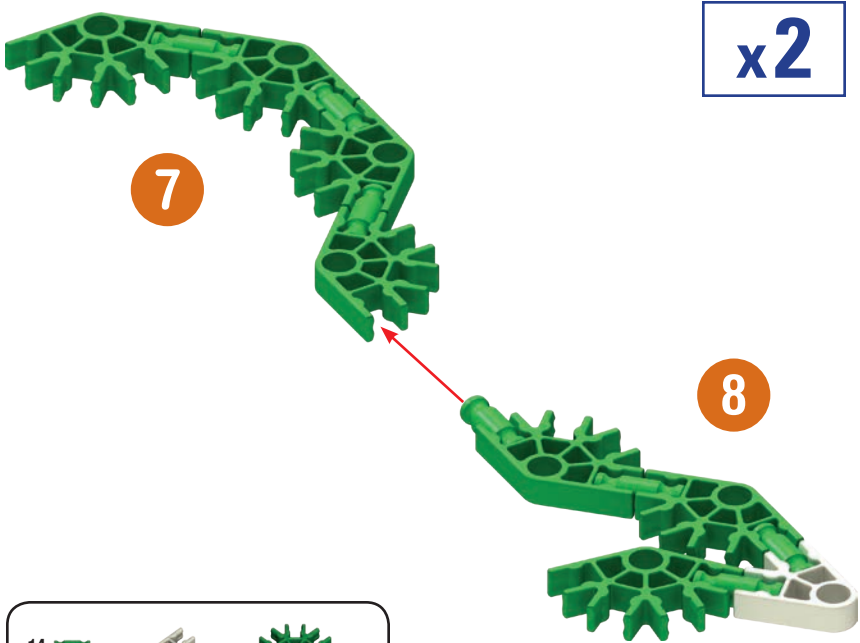

1 - 6



- 6 
- 6 
- 10  10 
- 4 

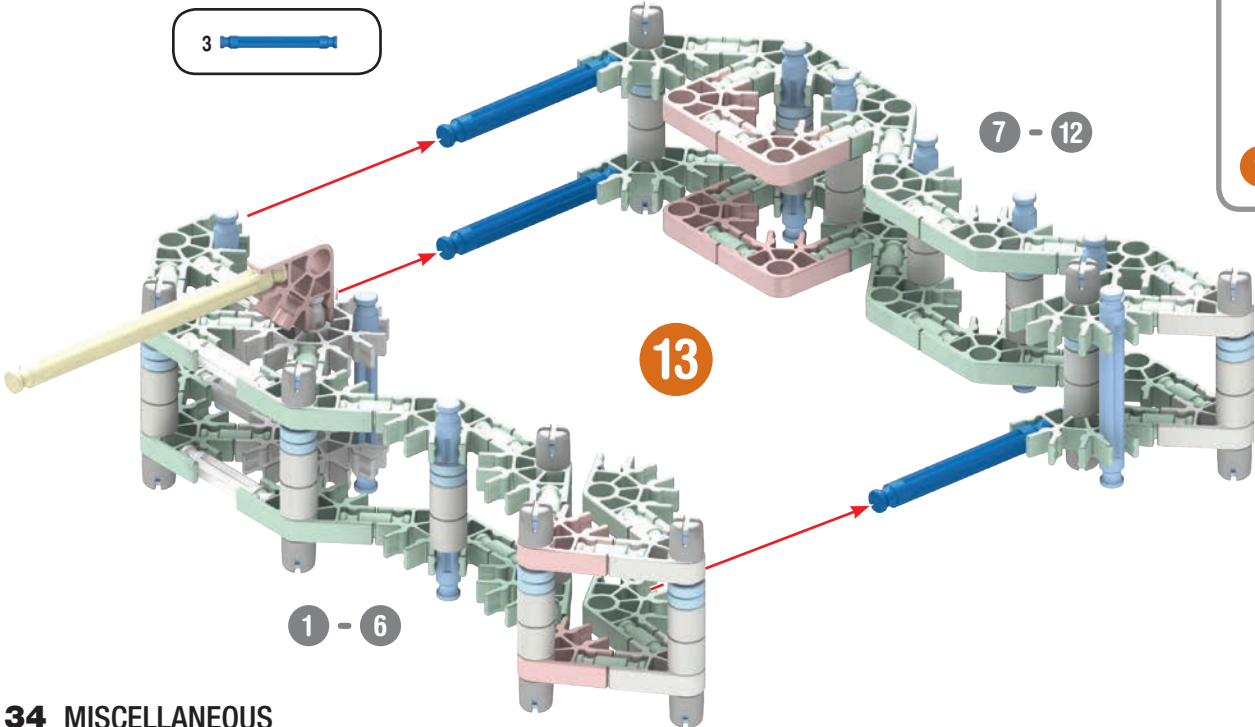
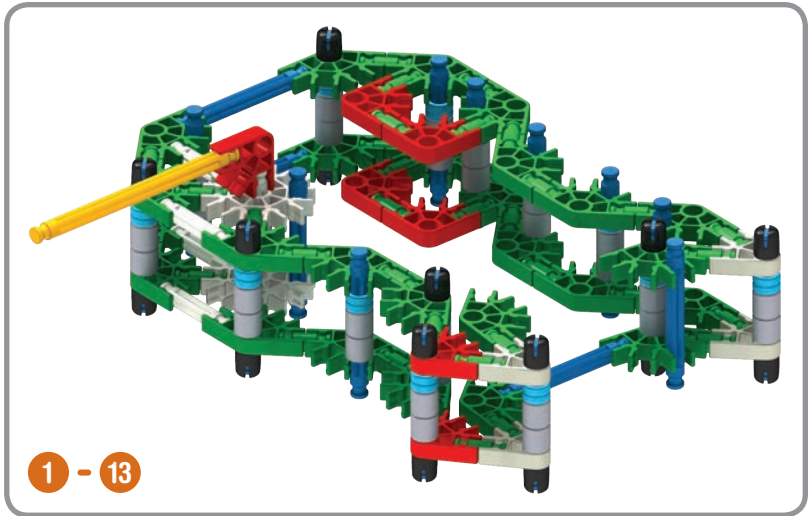
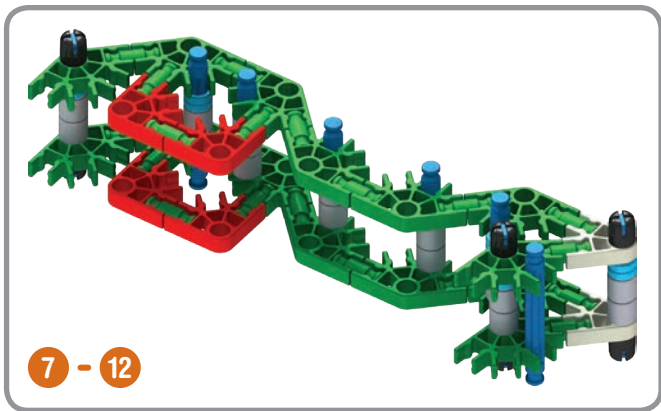
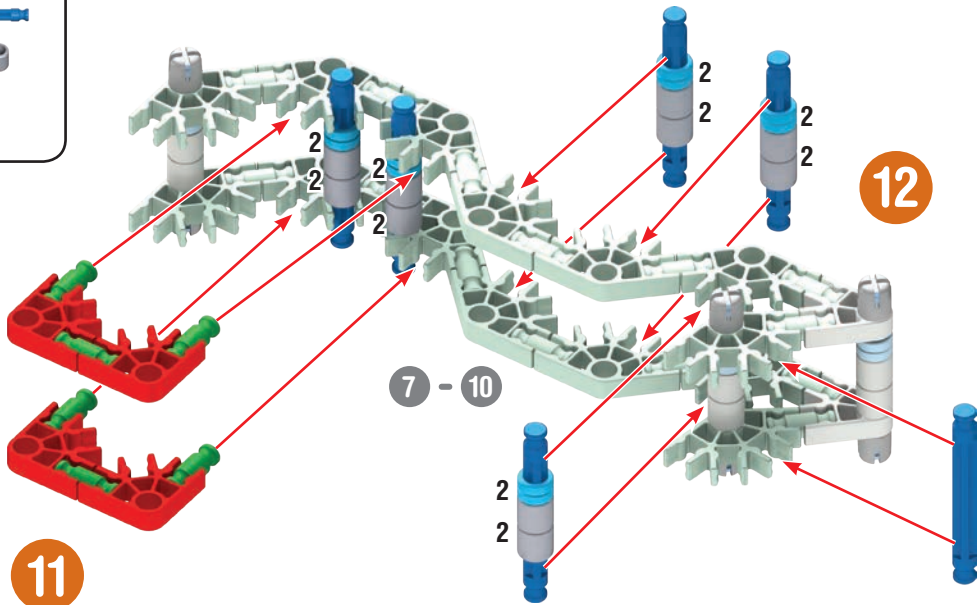

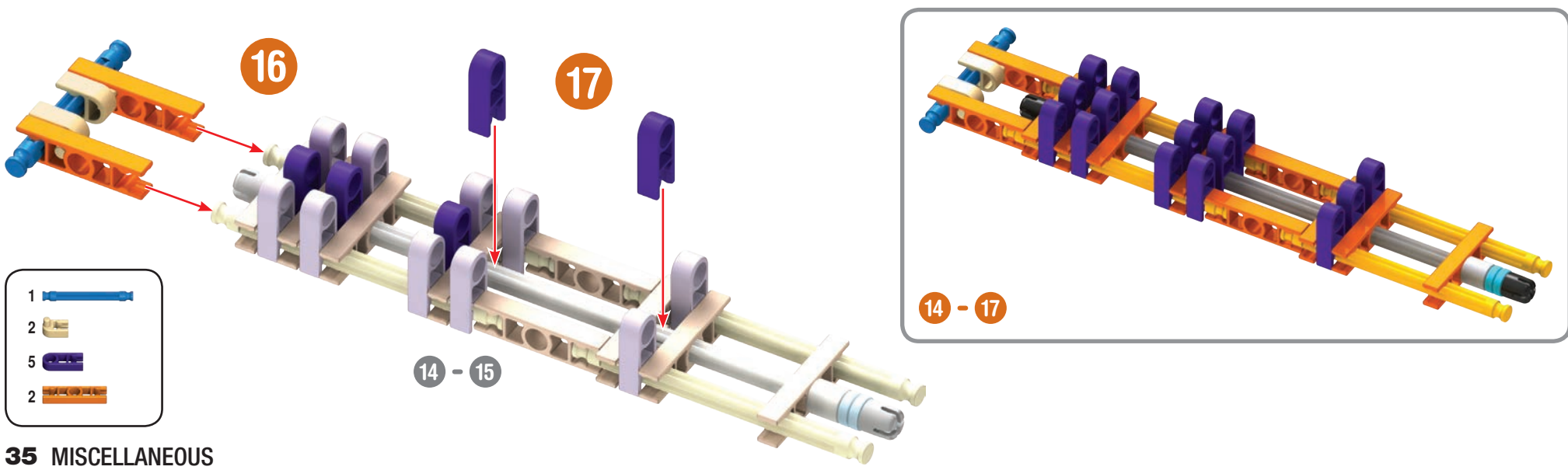
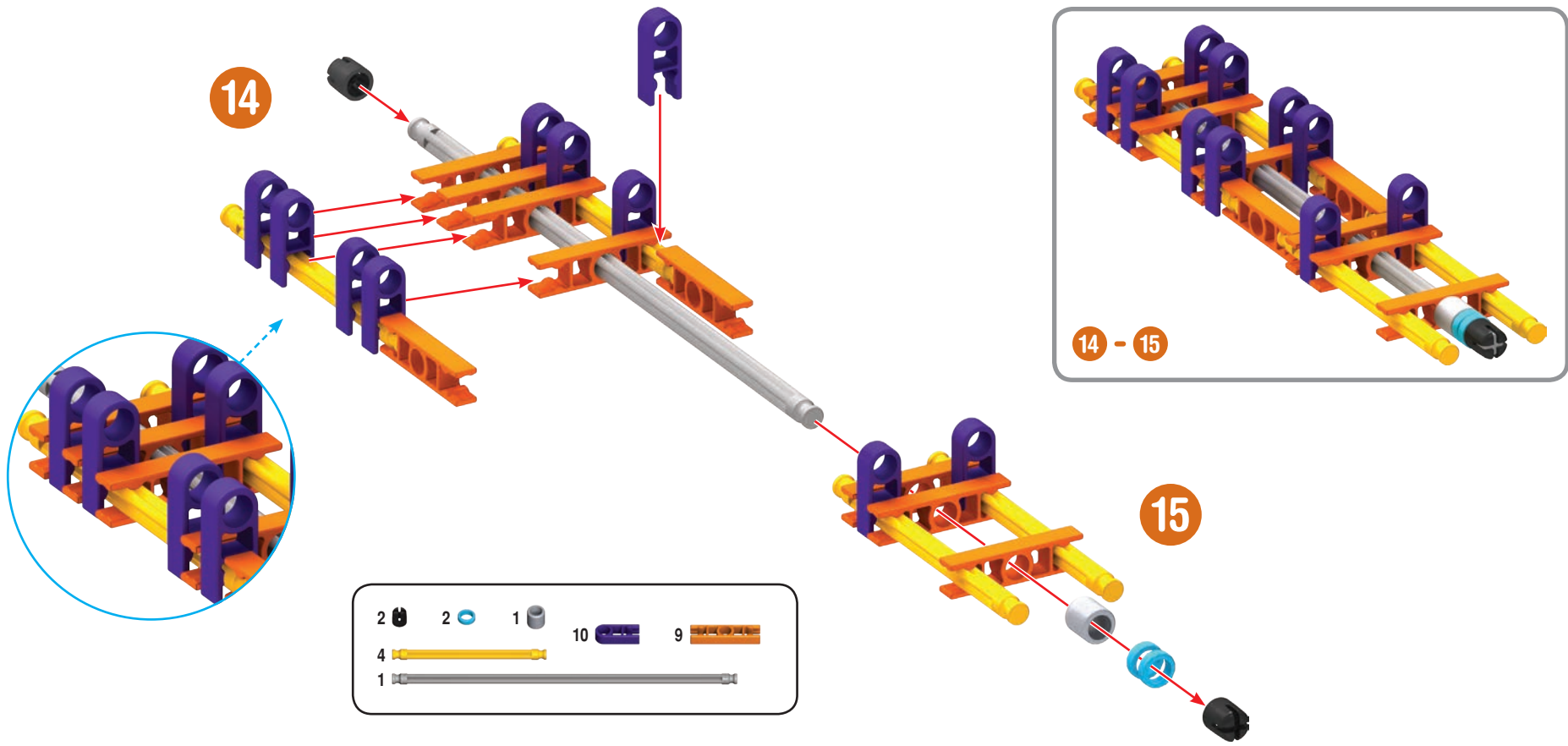

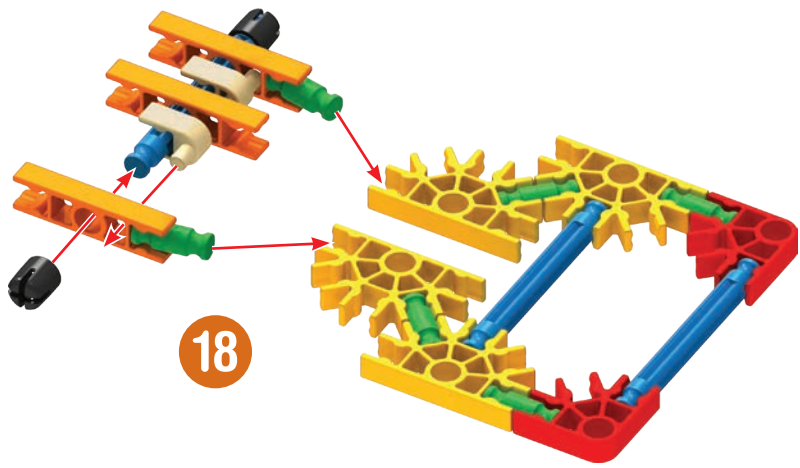

18

- | | | | | | |
|---|--|---|--|---|--|
| 6 | | 2 | | 2 | |
| 3 | | | | | |
| 3 | | 2 | | 4 | |

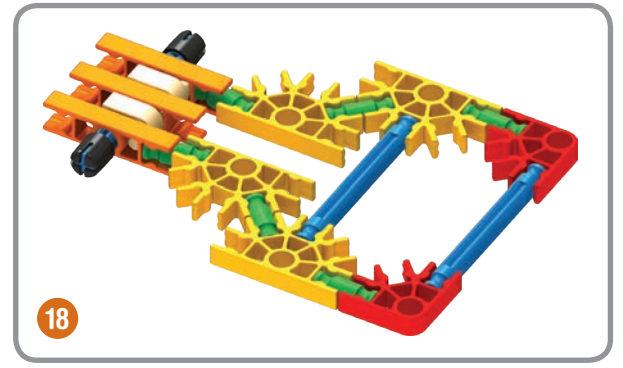

18

- | | | | | | |
|---|--|---|--|---|--|
| 1 | | 3 | | 2 | |
| 3 | | | | | |
| 3 | | | | | |

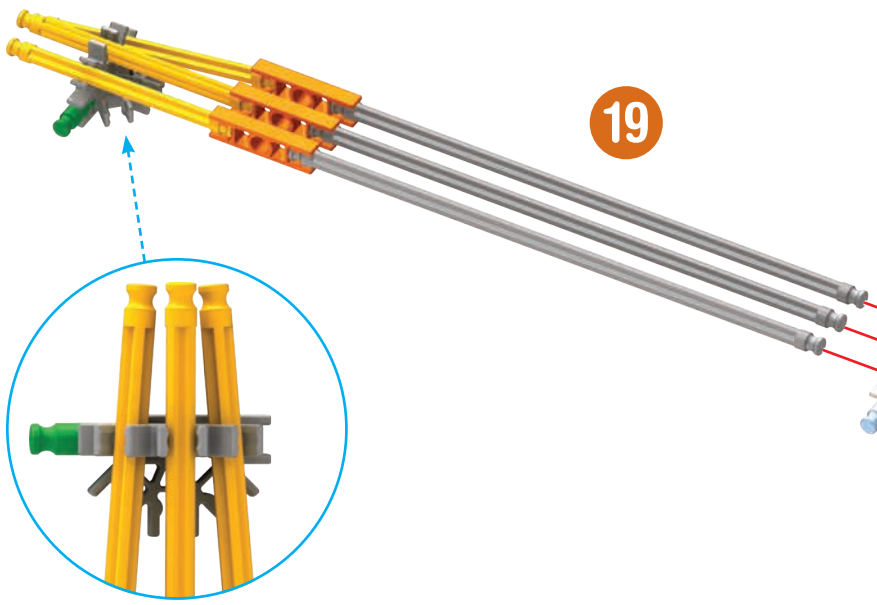

19

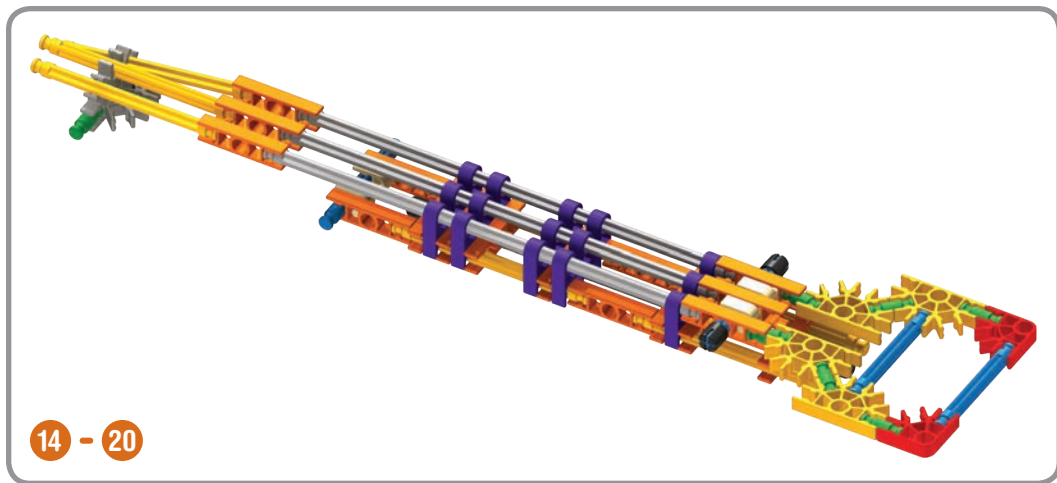

14 - 20

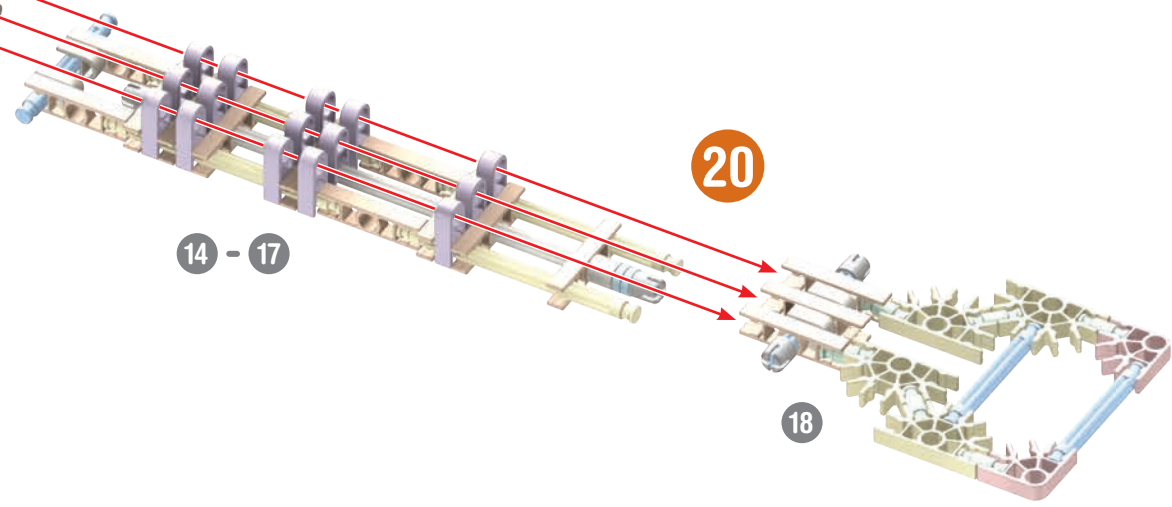

20

14 - 17

18

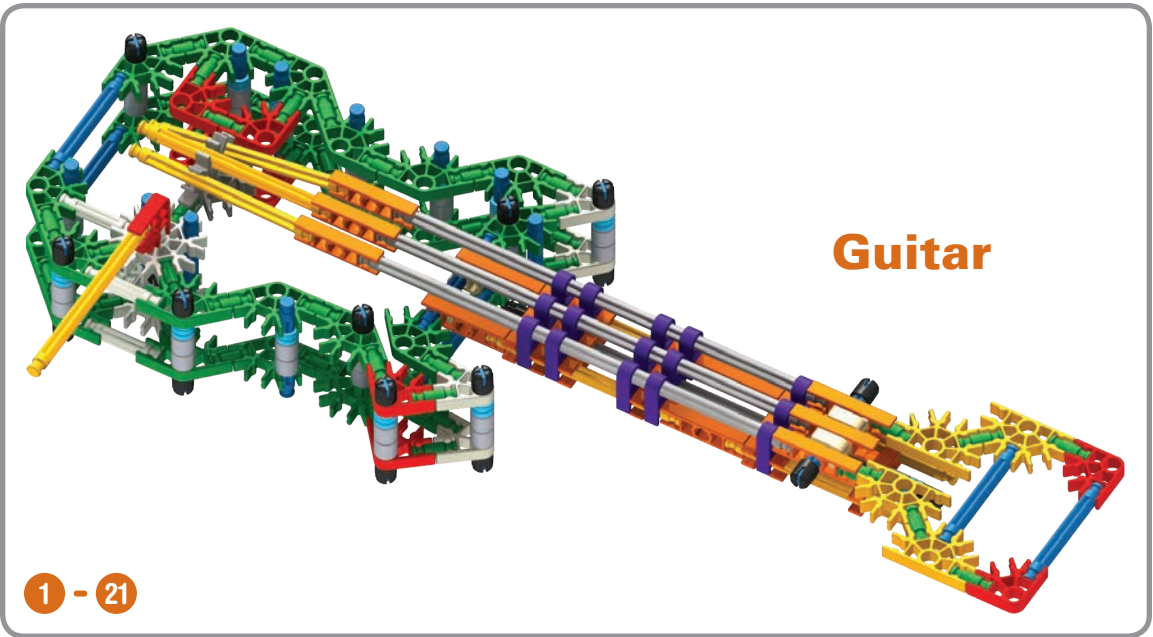

Guitar

1 - 21

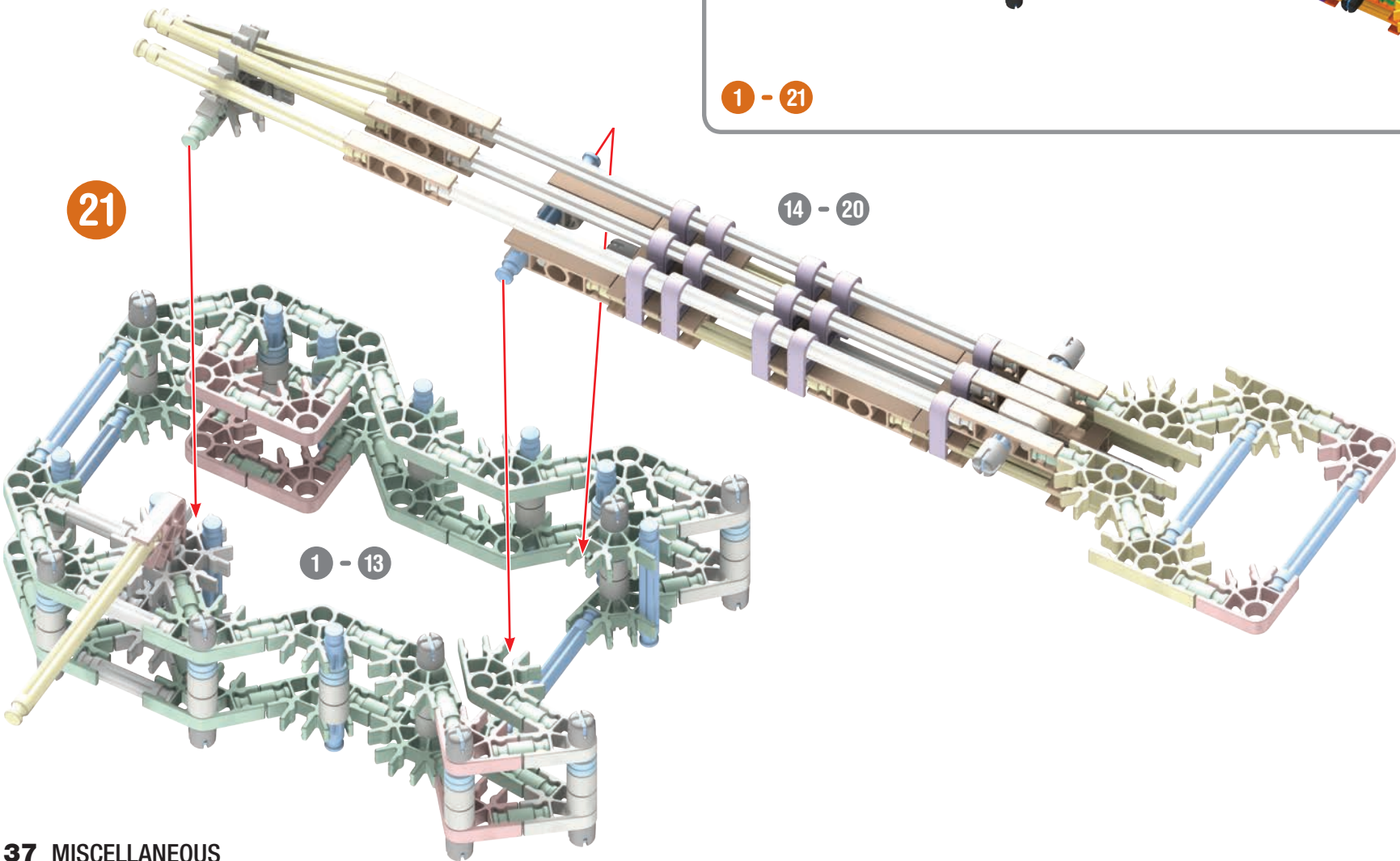

21

14 - 20

1 - 13

Mech

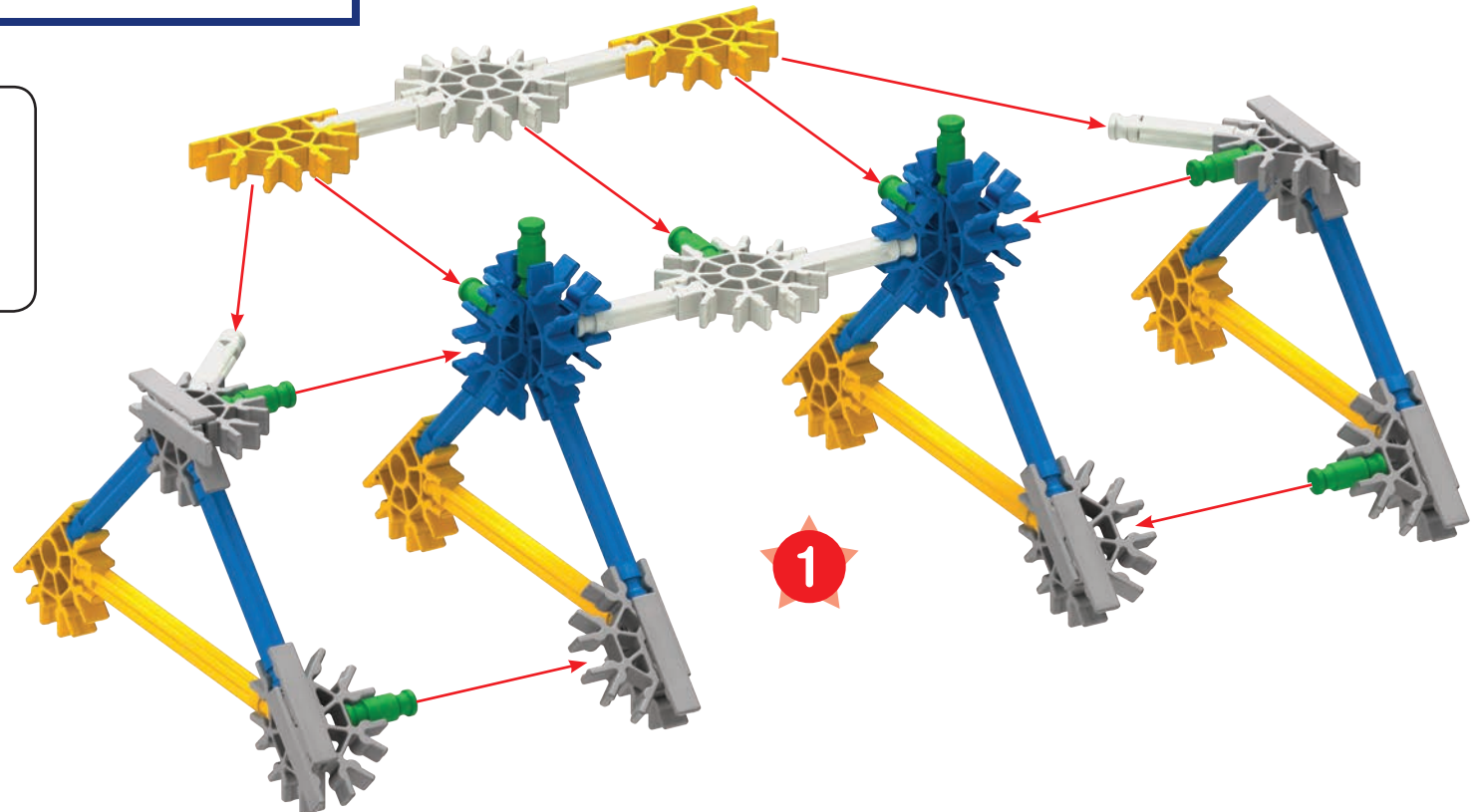
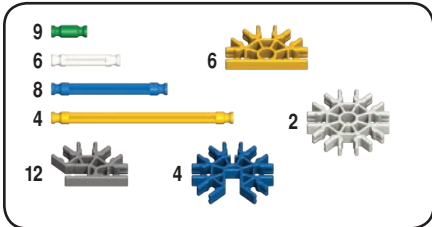
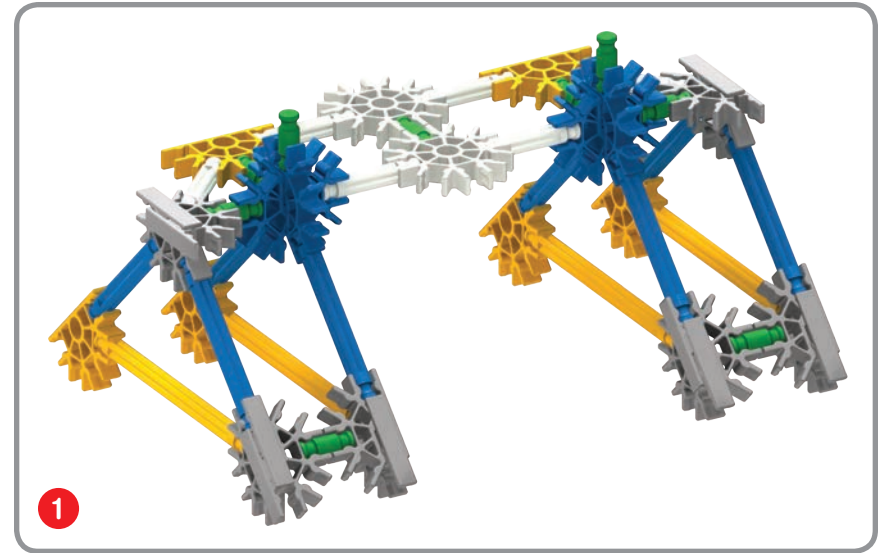
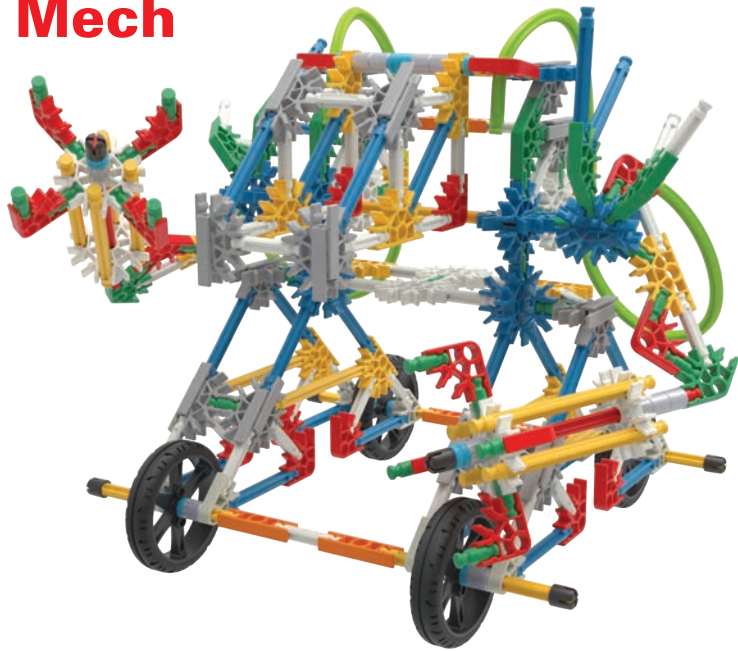

- 14
- 6
- 2
- 2
- 2
- 1
- 6
- 2
- 2
- 6
- 2

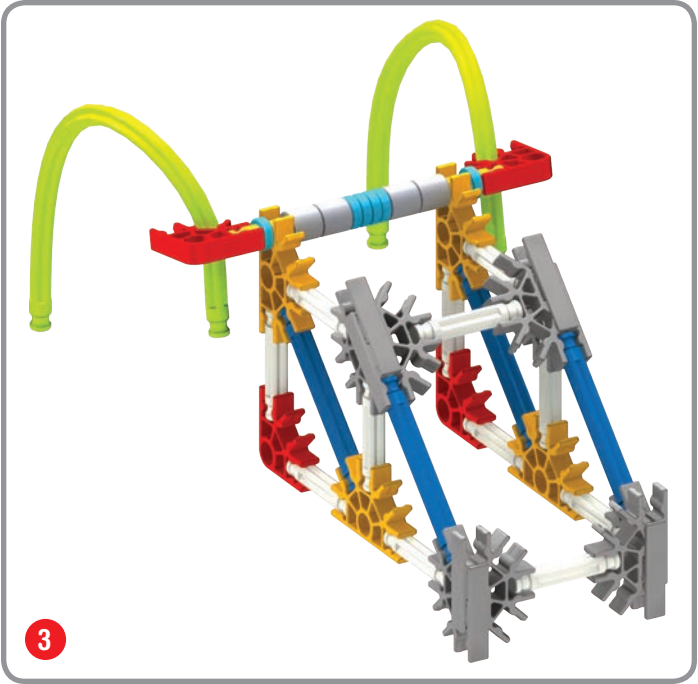
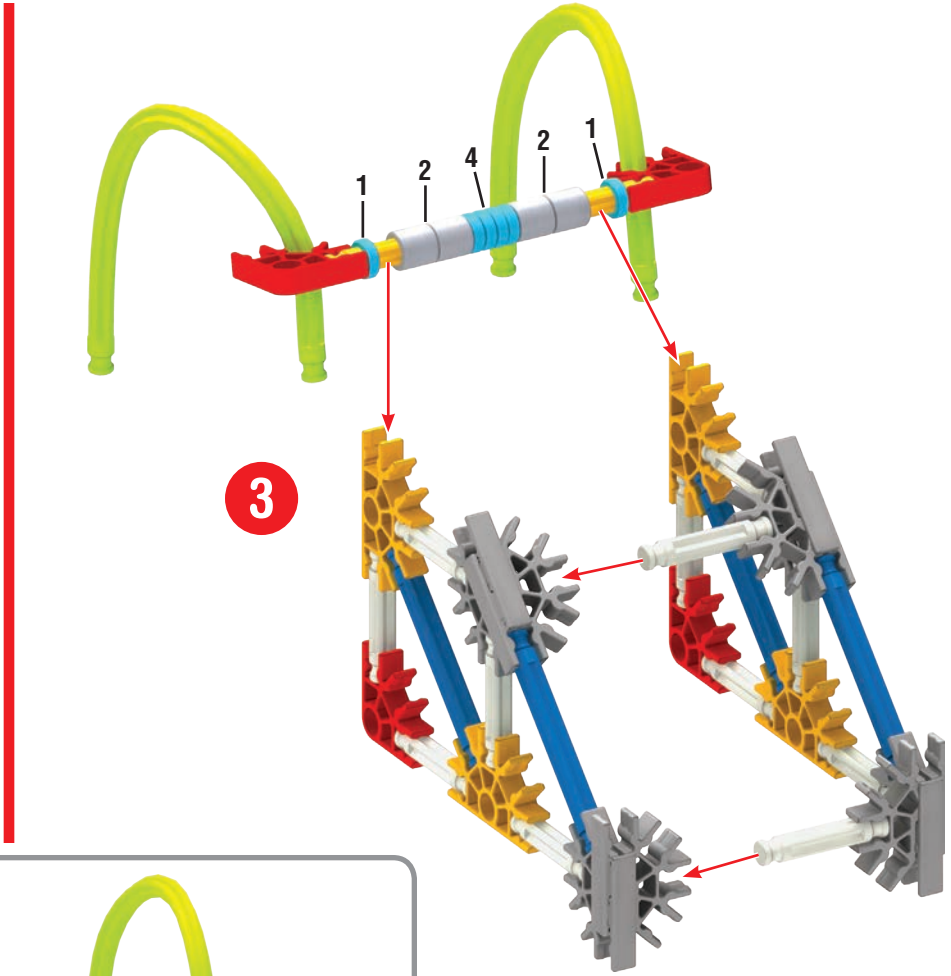
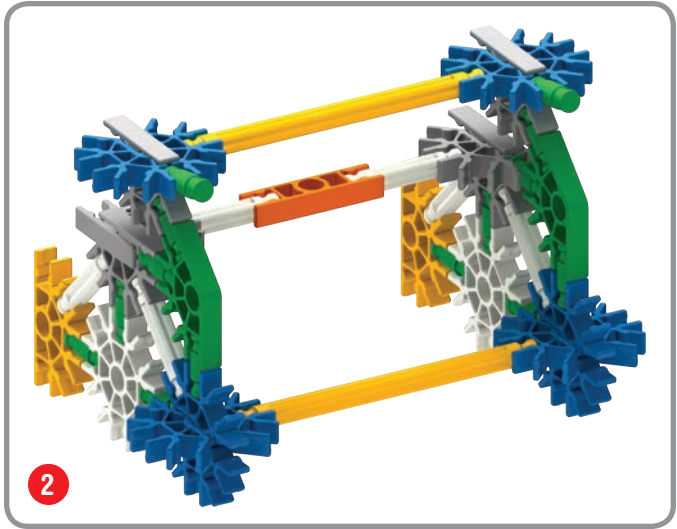
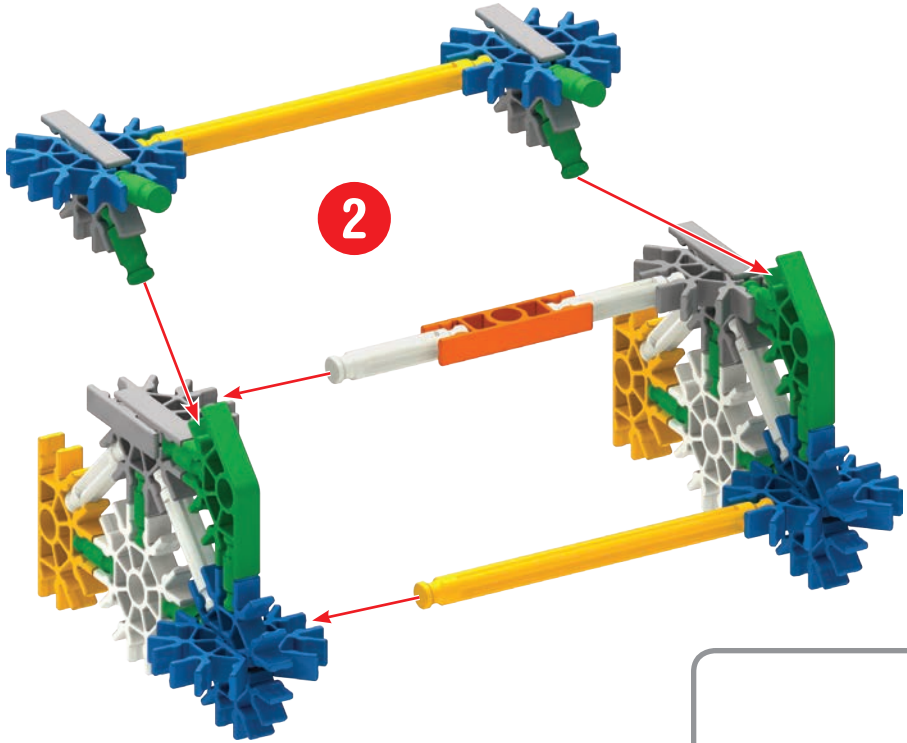

- 12
- 4
- 1
- 2
- 4
- 6
- 4
- 4
- 8

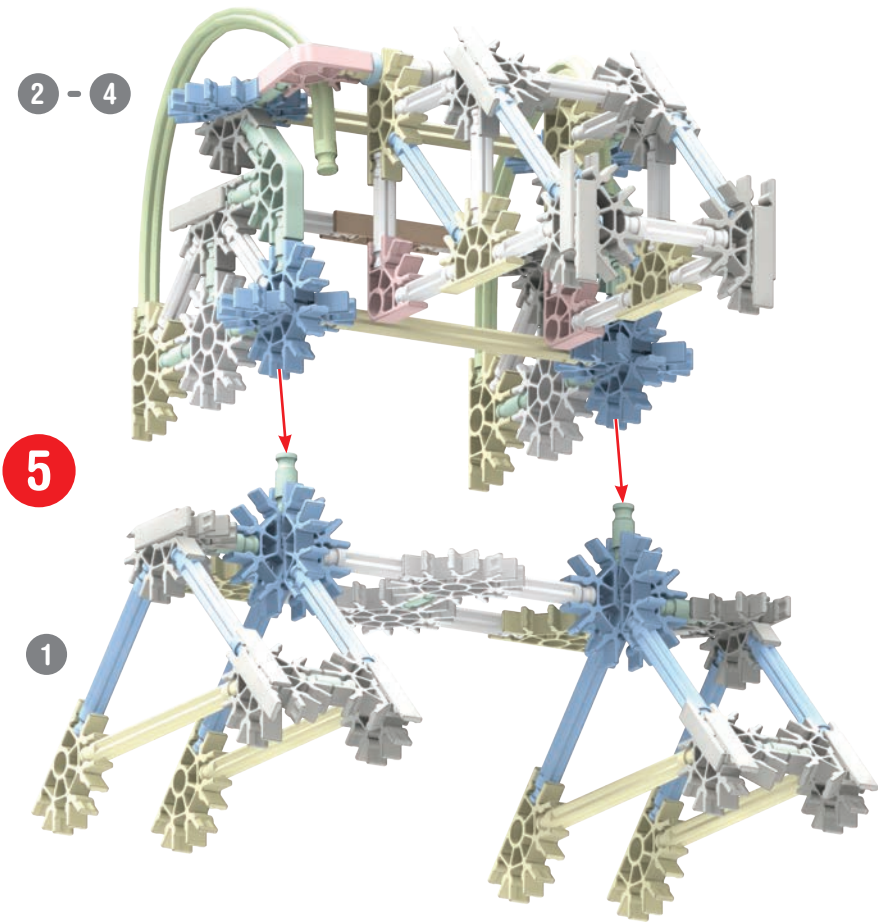
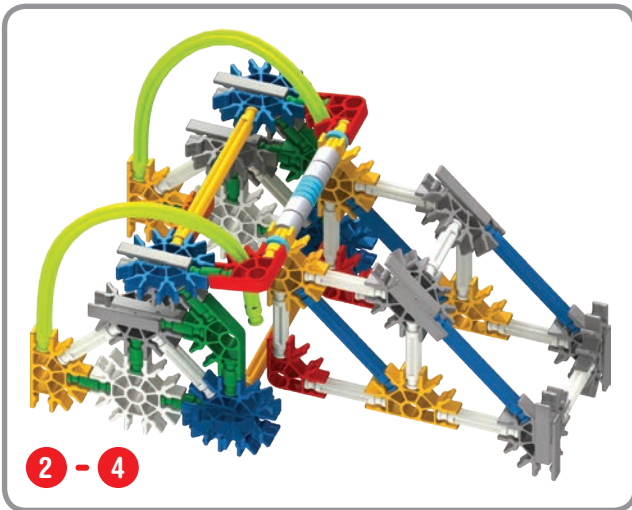
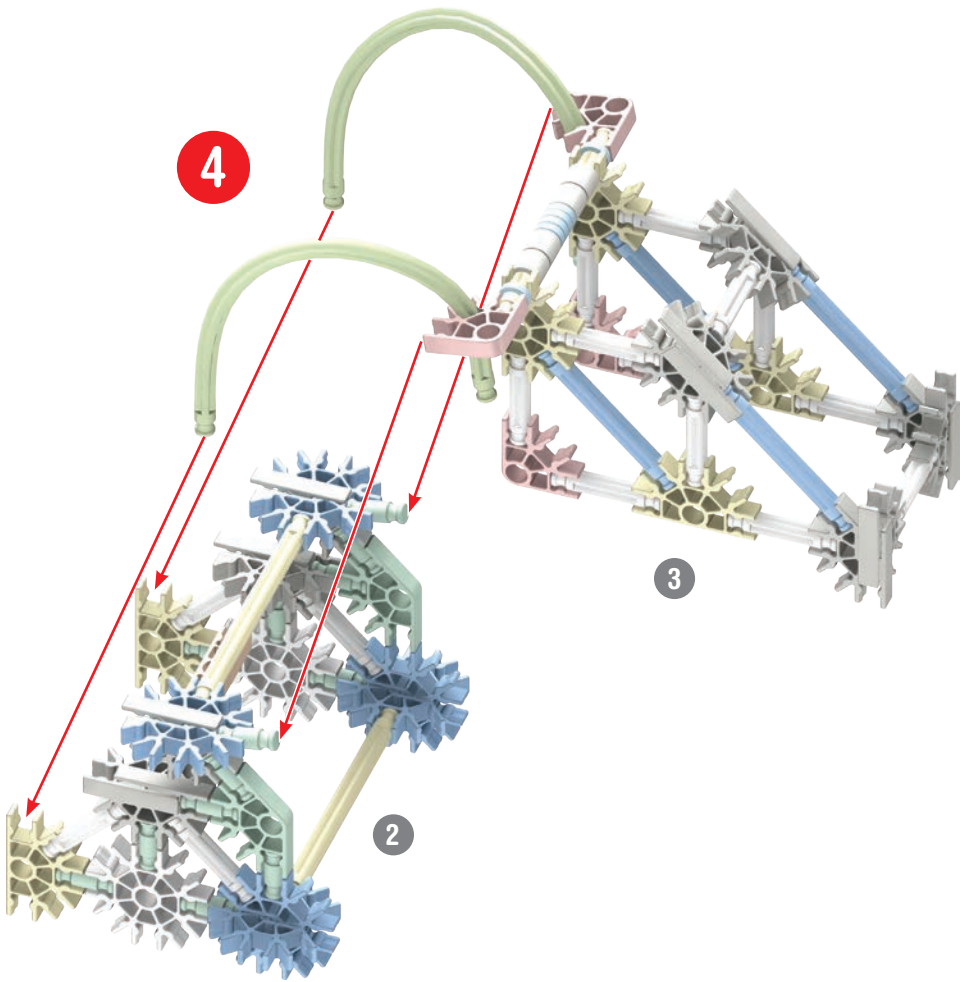



- | | | | | | | | | | | | |
|---|--|---|--|---|--|---|--|---|--|---|--|
| 4 | | 4 | | 4 | | 2 | | 2 | | 2 | |
| 9 | | 4 | | 2 | | 4 | | | | | |
| 2 | | | | | | | | | | | |

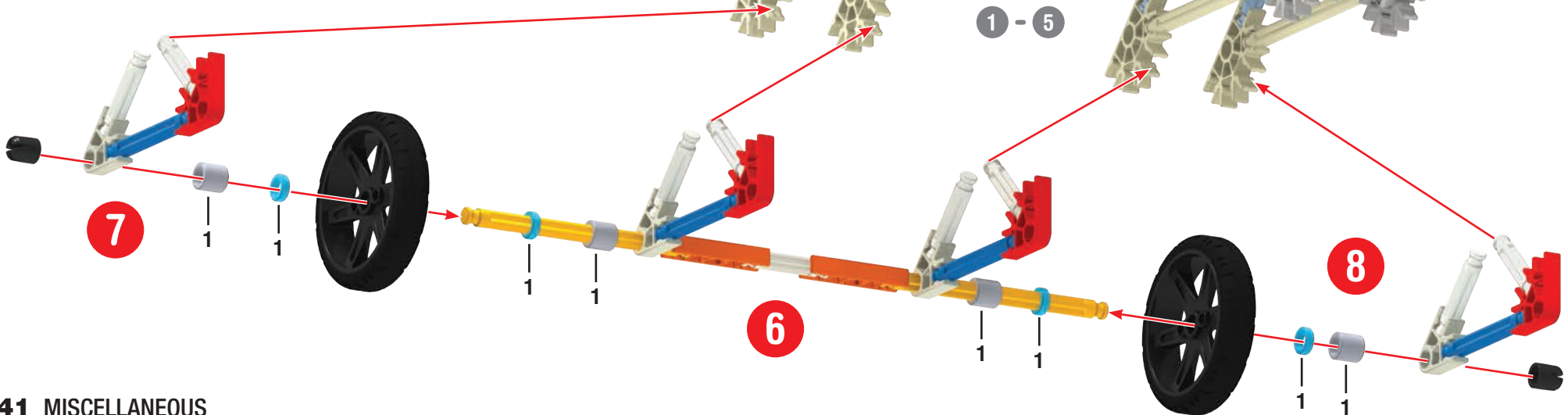
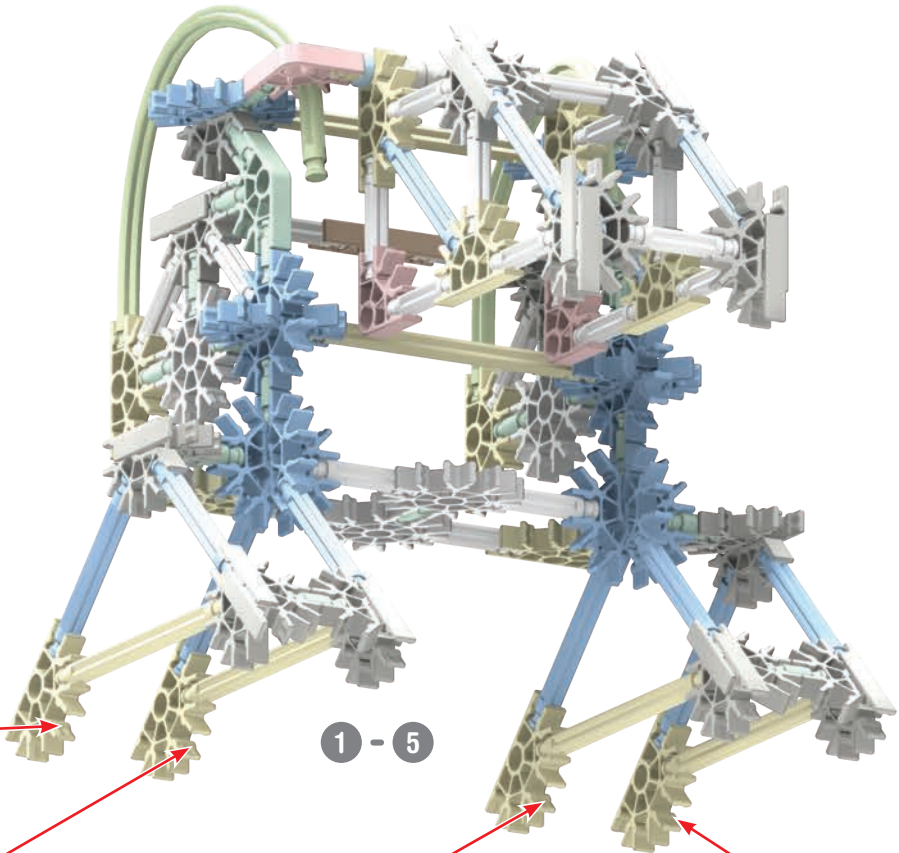

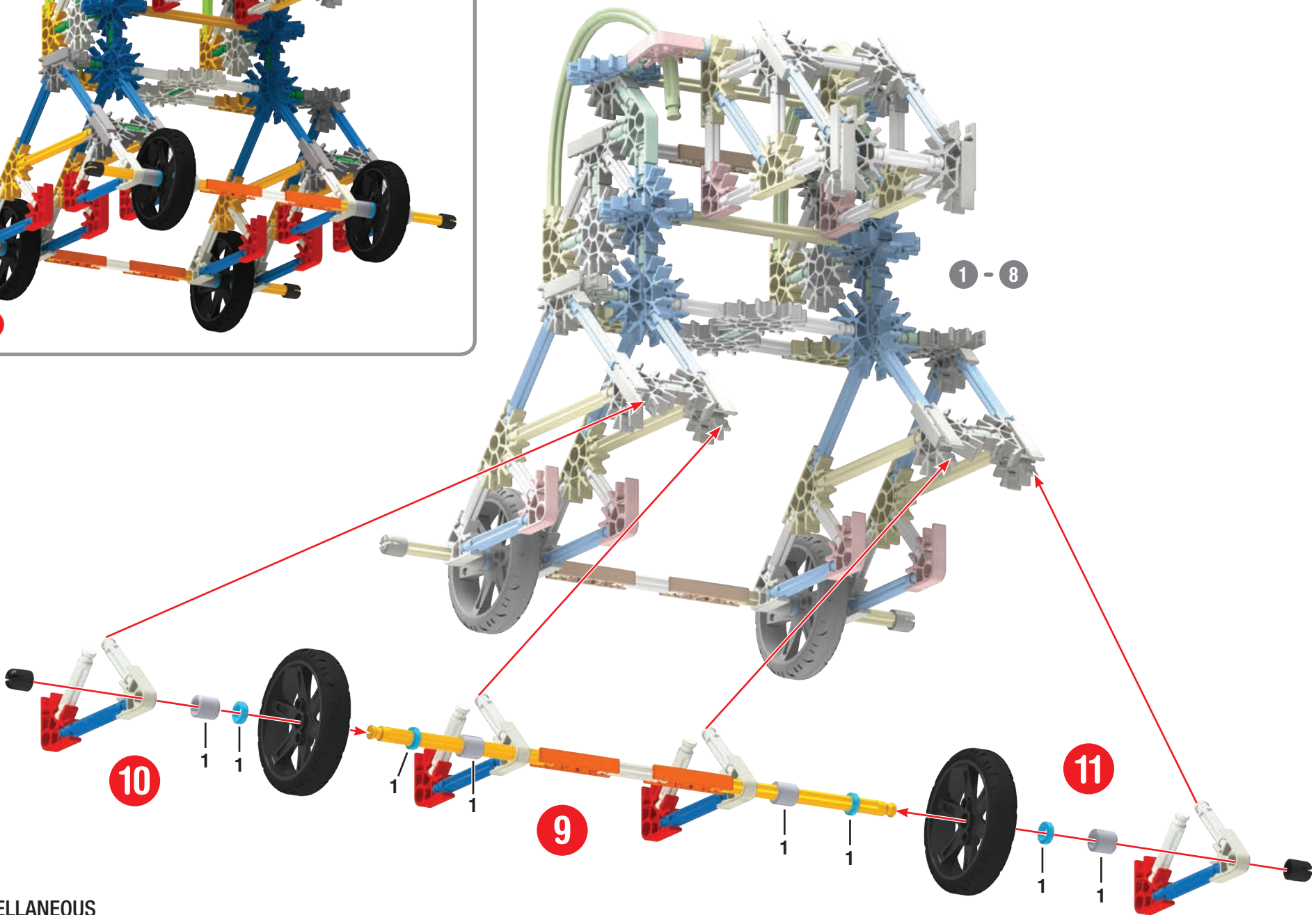
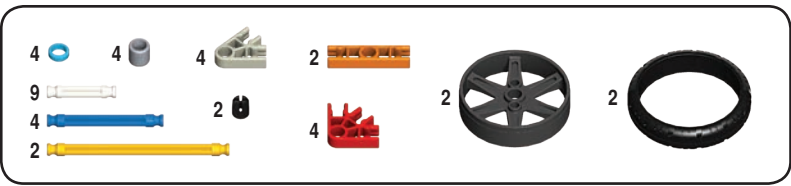
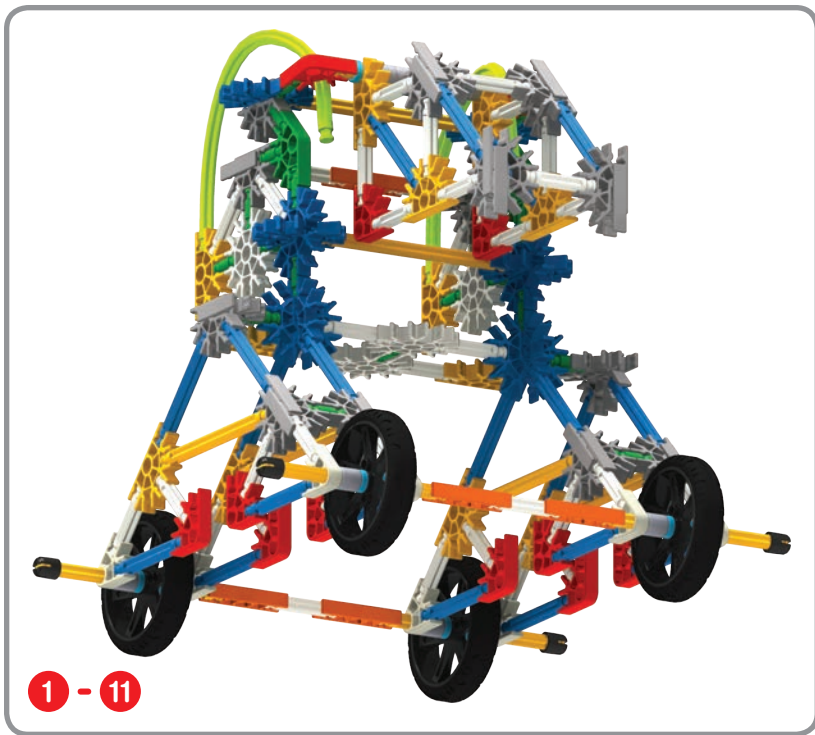

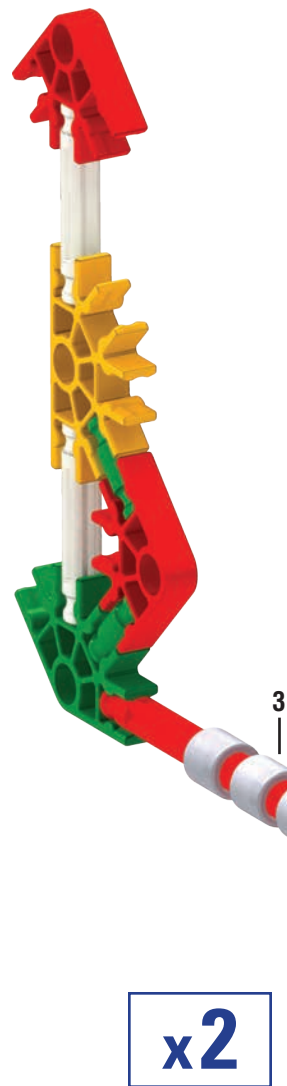

x2

- | | | | | | | | | |
|----|--|---|--|---|--|---|--|---|
| 20 | | 2 | | 4 | | 8 | | |
| 4 | | | | | | | | |
| 8 | | | | | | | | 4 |
| 2 | | | | | | | | |
| 12 | | 2 | | 2 | | | | |

12

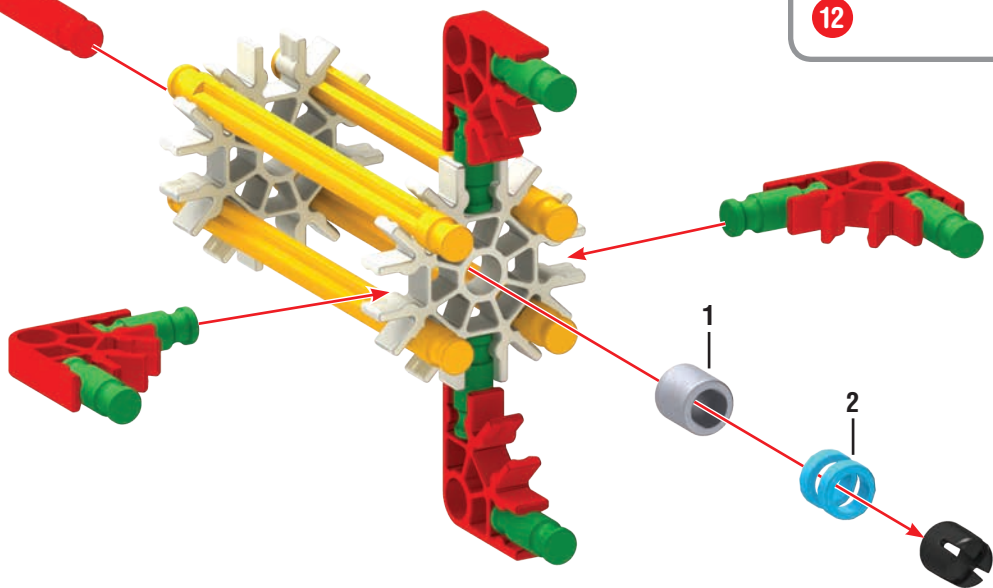

12

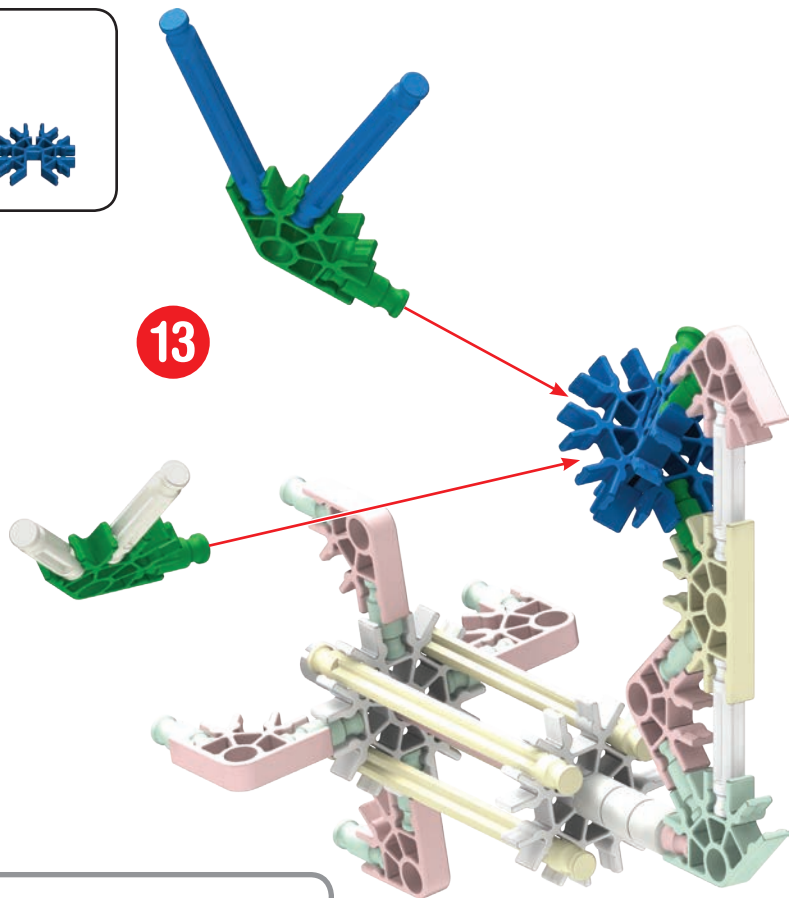
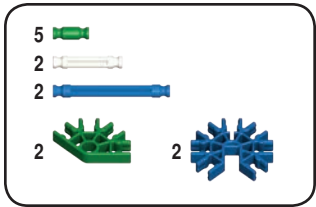

12

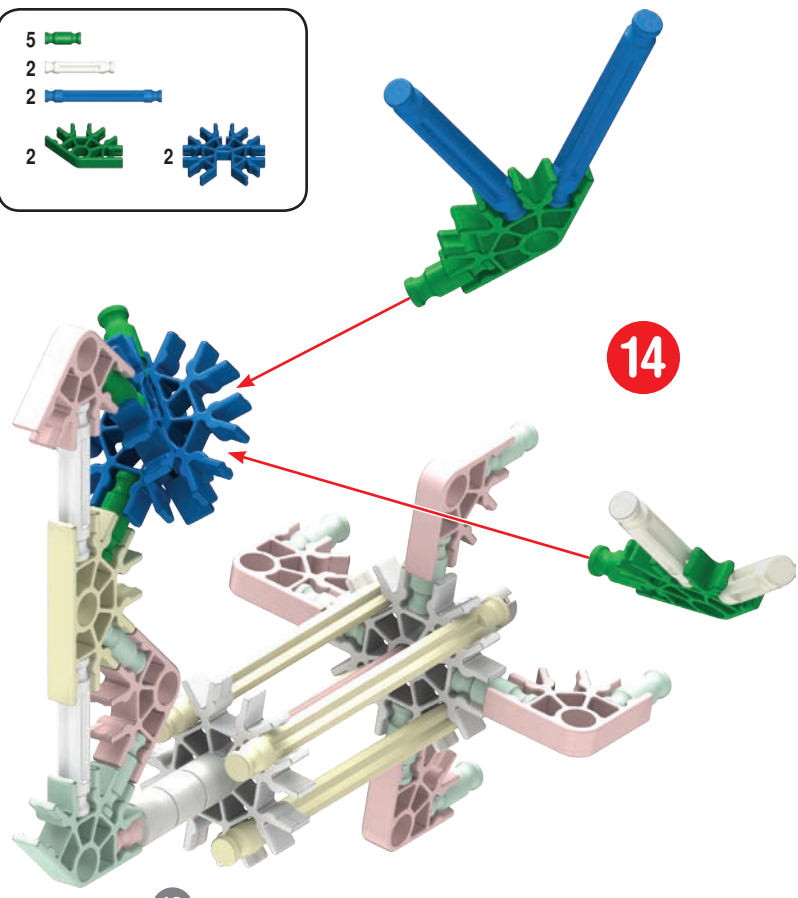
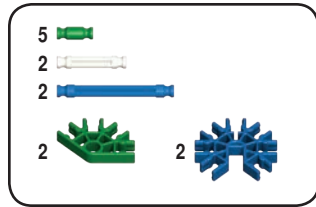
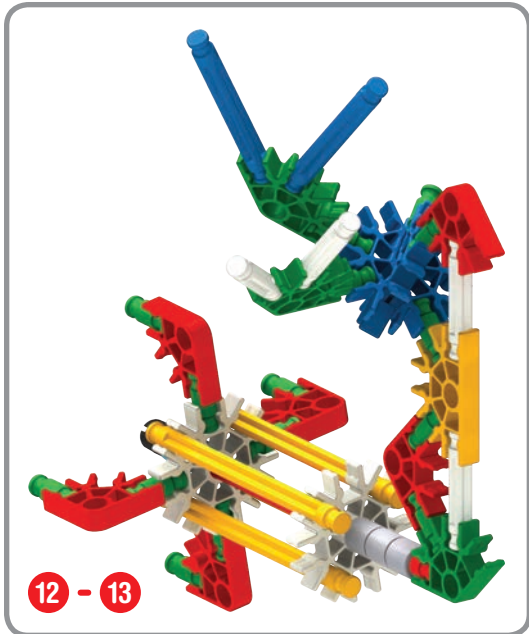

12



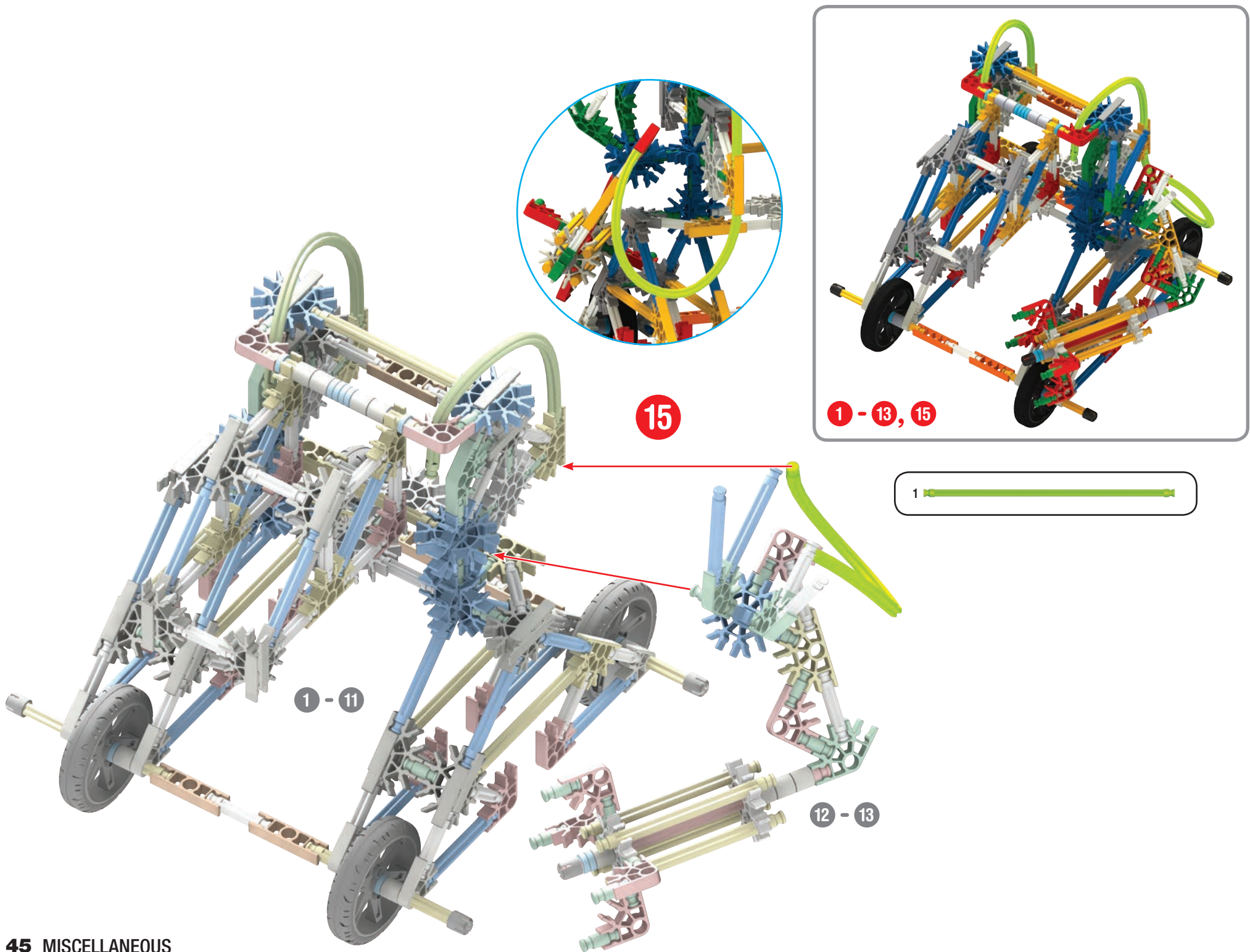

Mech

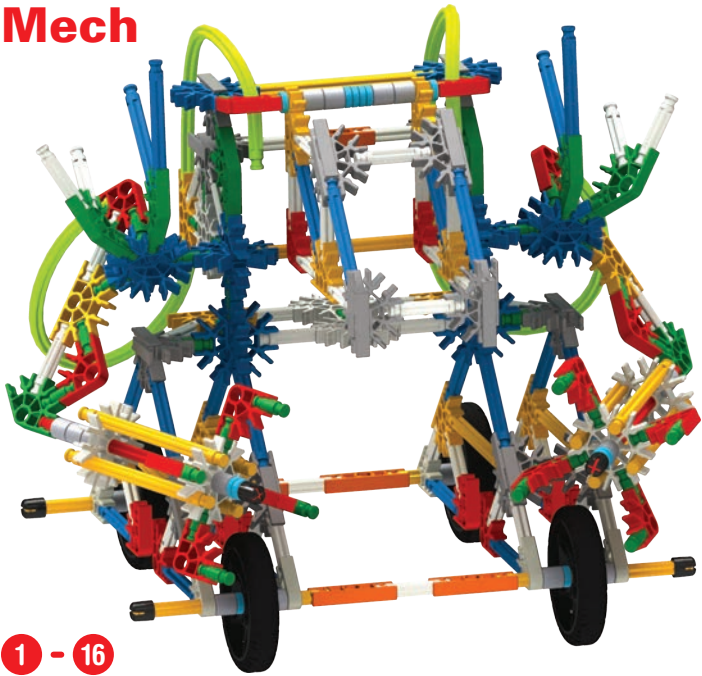

1 - 16

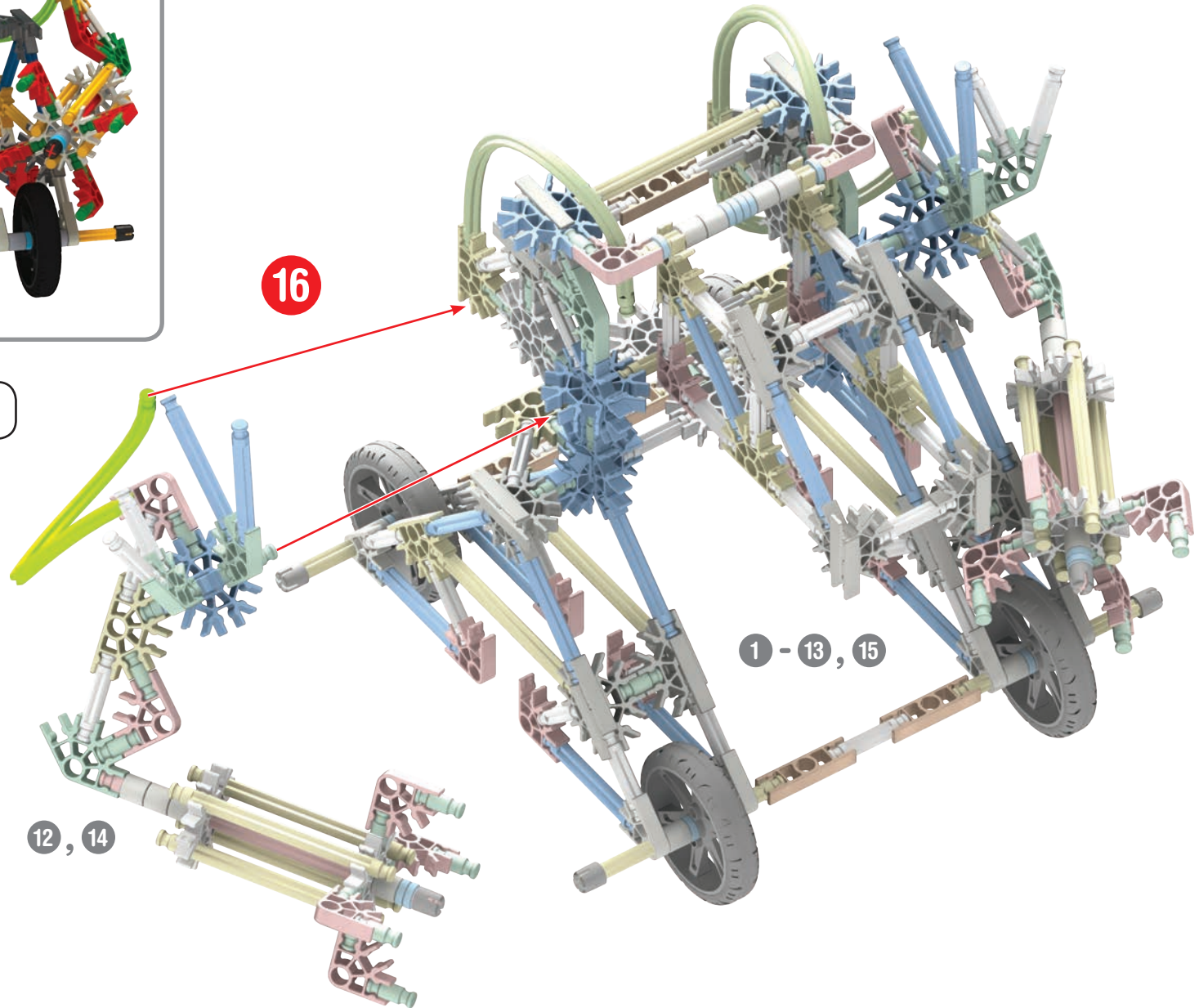

16

1 - 13, 15

12, 14



**Metal
Detector**

- | | | | | |
|----|--|--|---|--|
| 10 | | | 8 | |
| 12 | | | | |
| 4 | | | | |

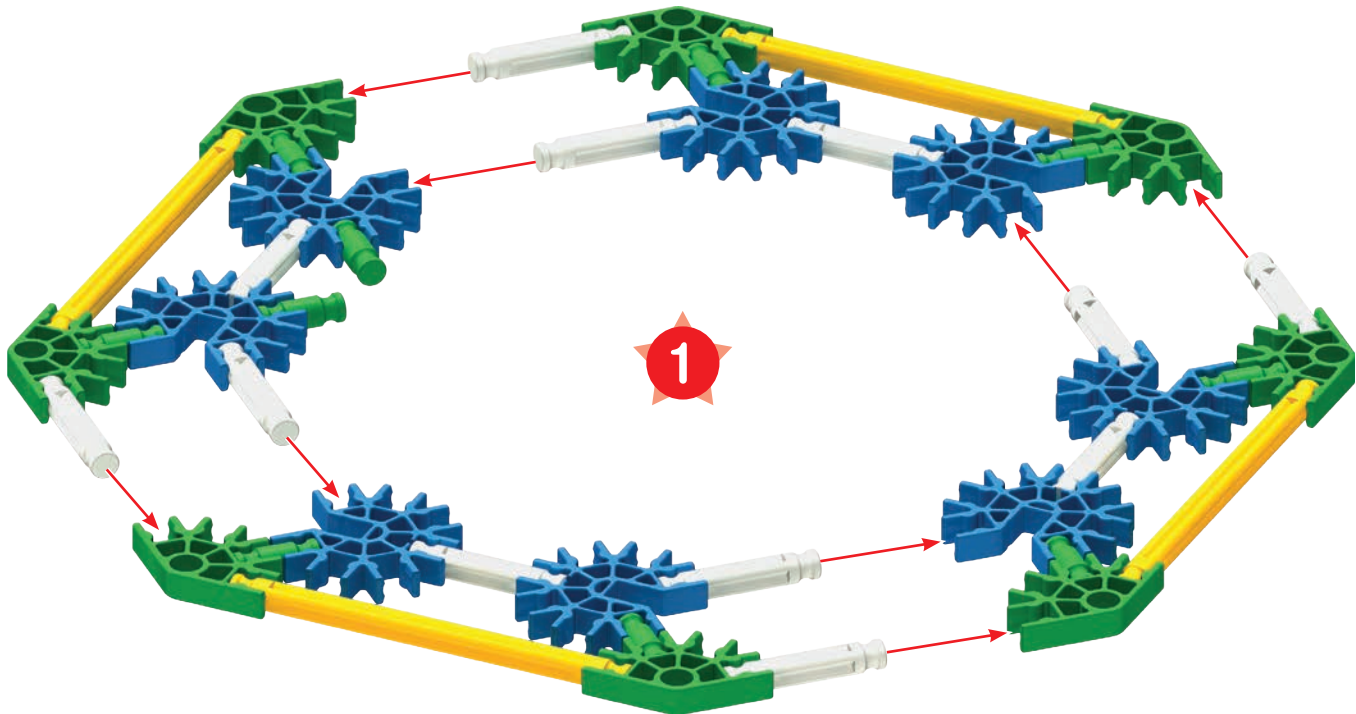
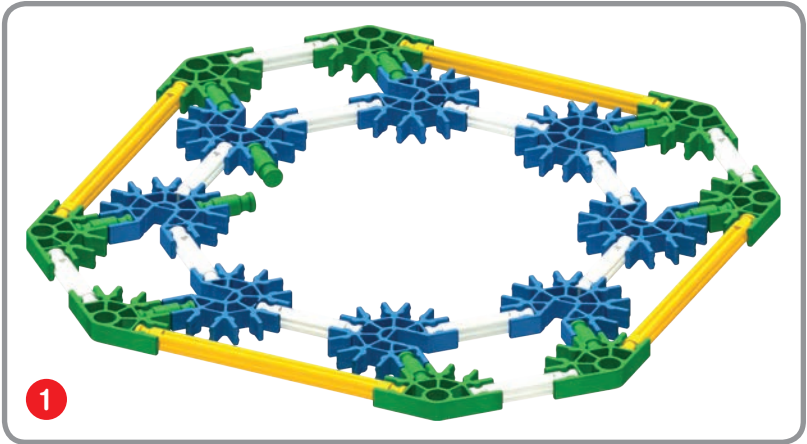

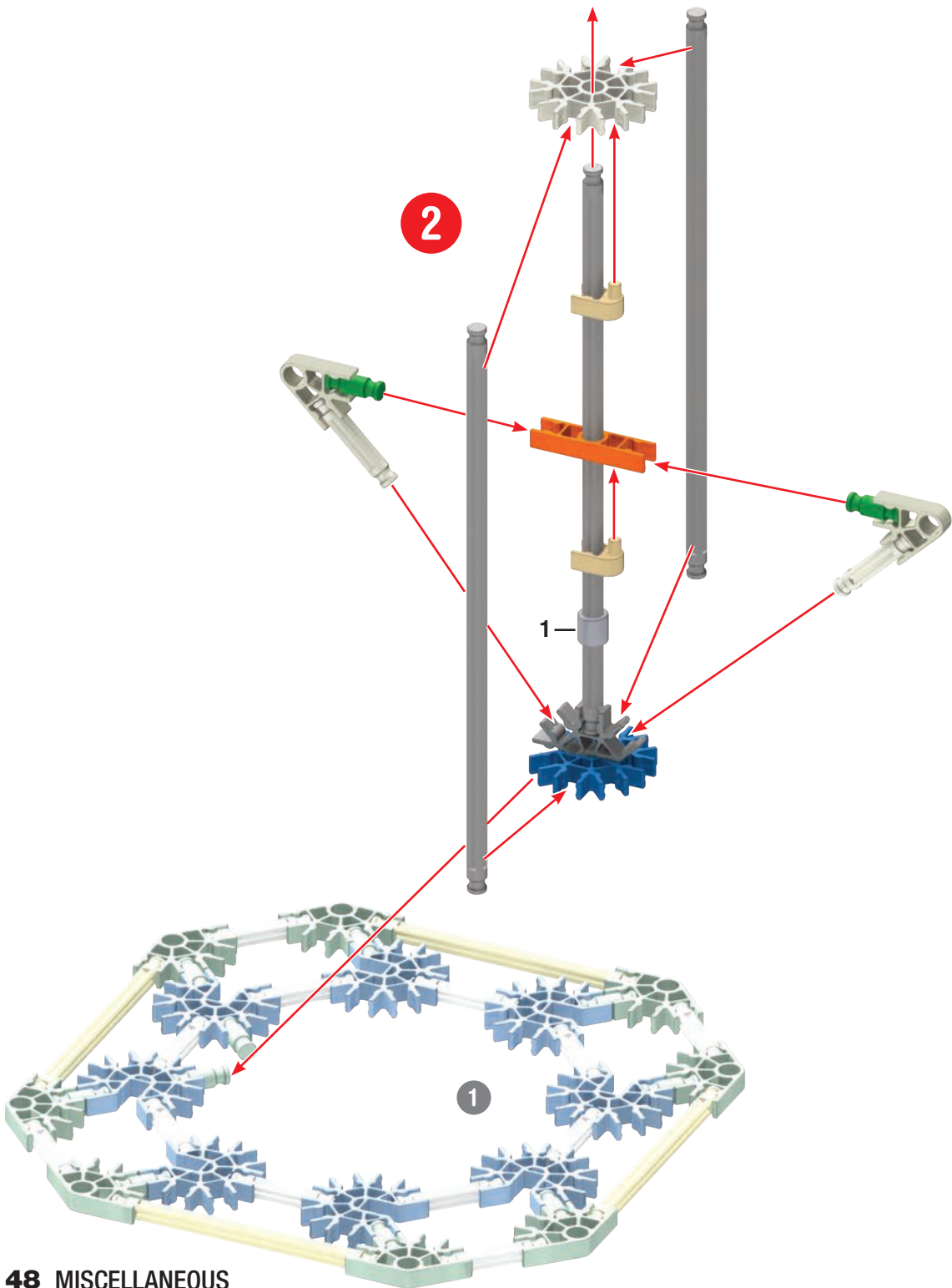

- | | | | | | | | |
|---|--|---|--|---|--|---|--|
| 2 | | 1 | | 2 | | 1 | |
| 2 | | | | | | | |
| 3 | | | | | | | |
| 2 | | 1 | | 1 | | 1 | |

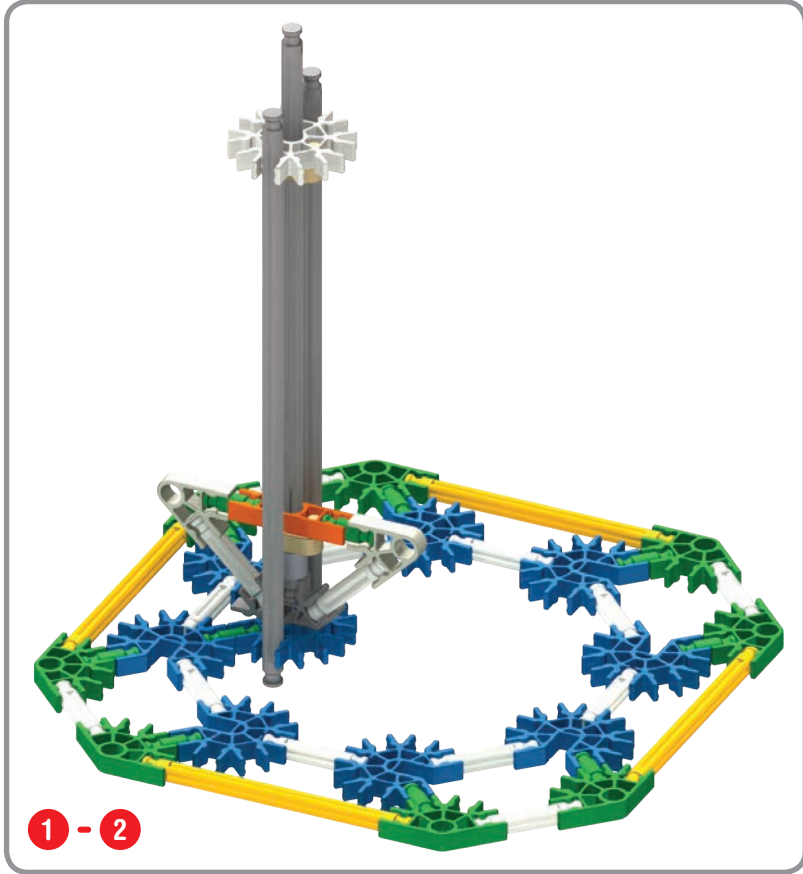

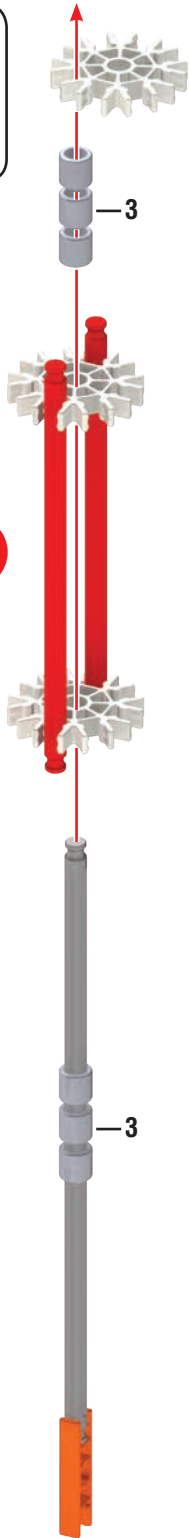
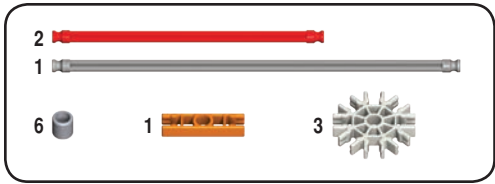

3

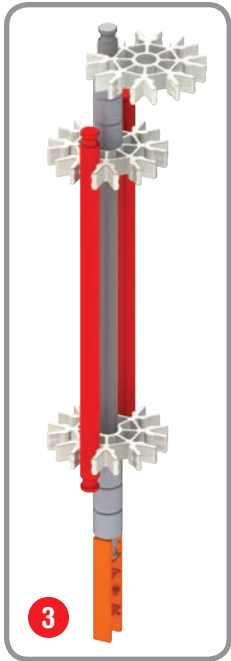

3

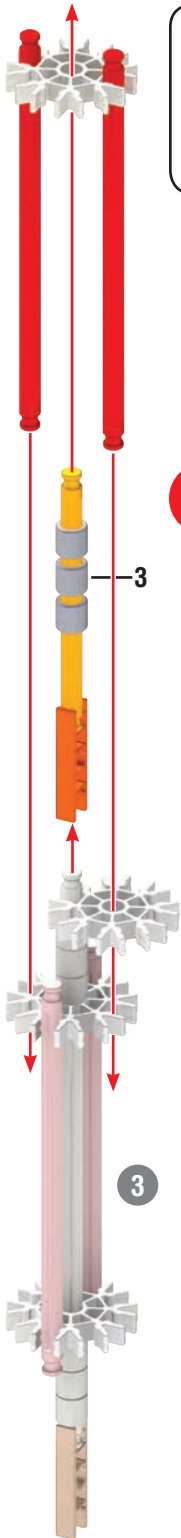
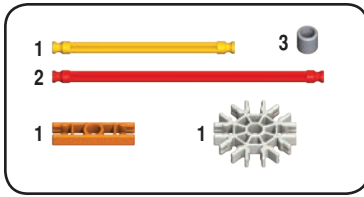

4

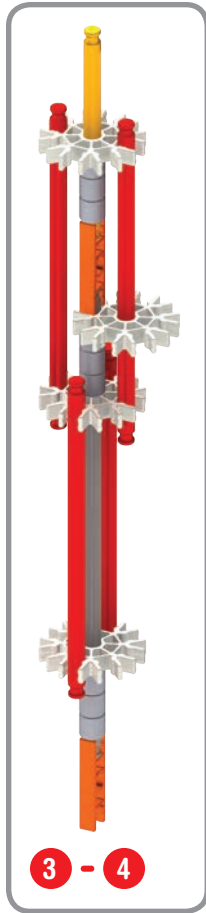

3 - 4

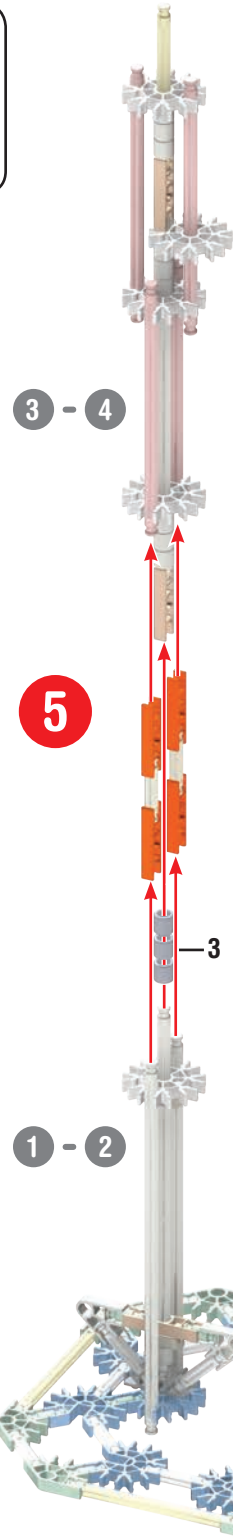

3 - 4

5

1 - 2

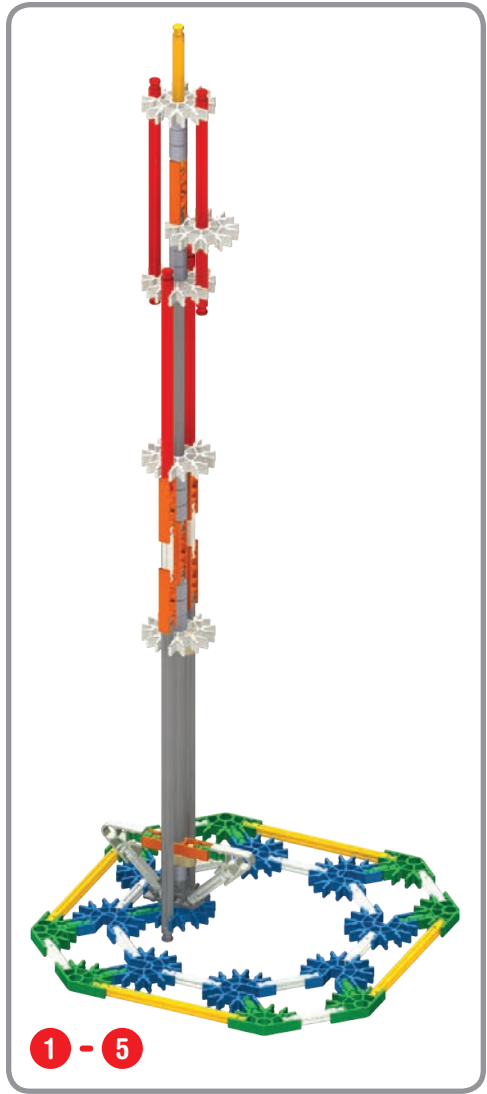

1 - 5

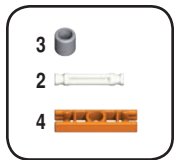

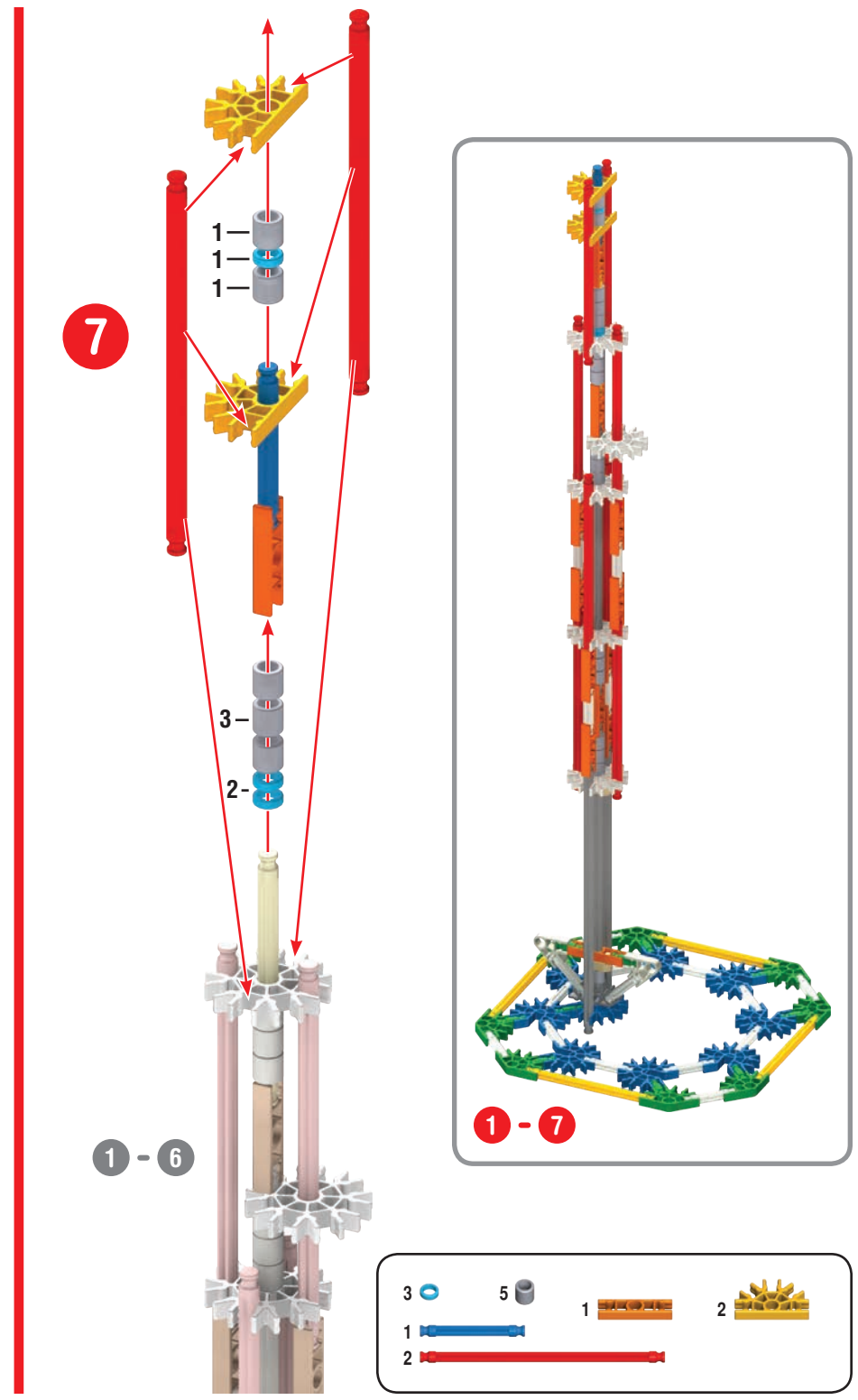
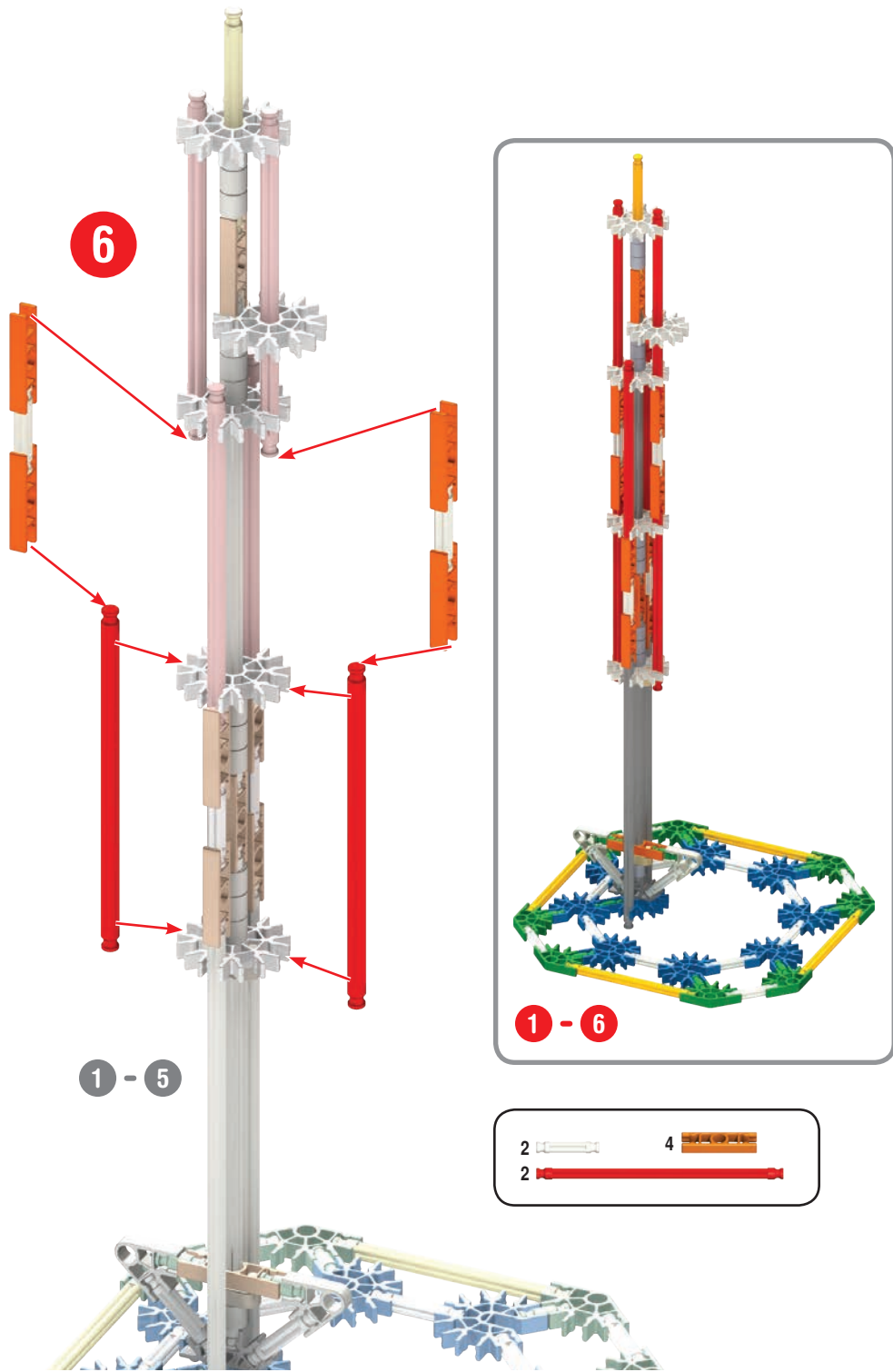

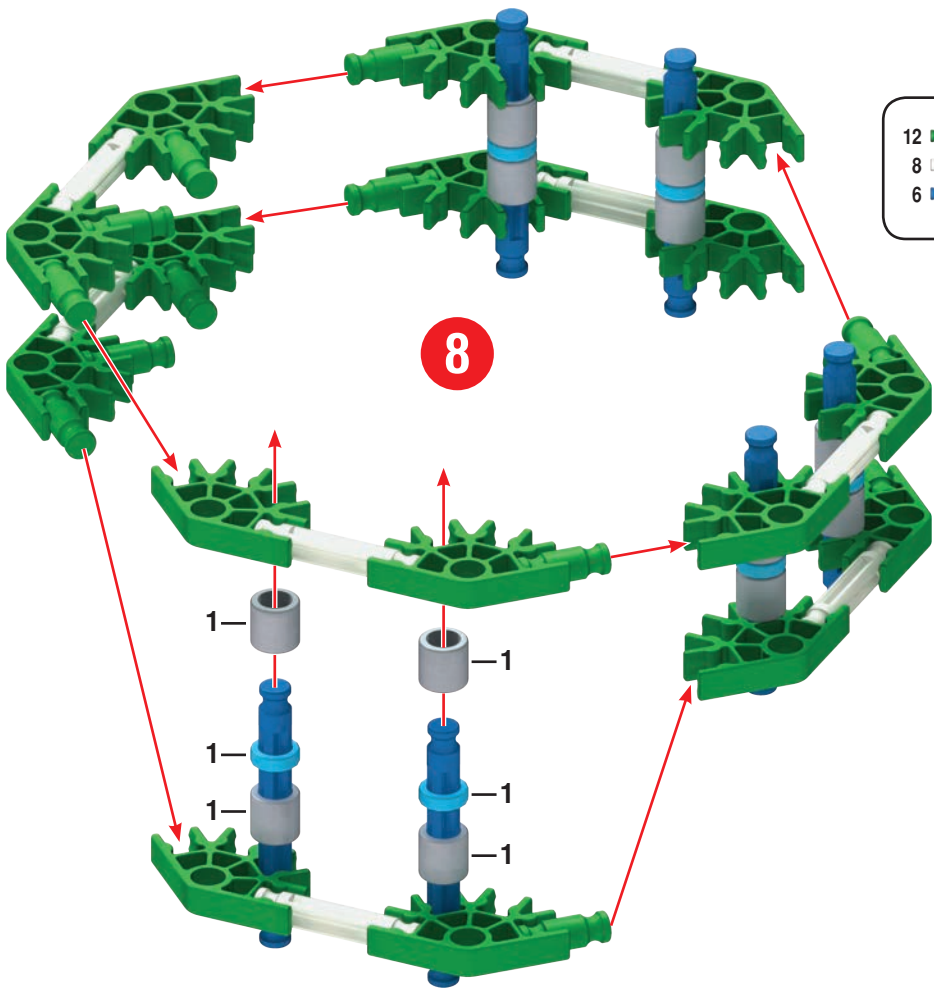

- | | | | | | |
|----|--|---|--|----|--|
| 12 | | 6 | | 12 | |
| 8 | | 6 | | 16 | |

8

- 1
- 1
- 1
- 1
- 1
- 1
- 1
- 1

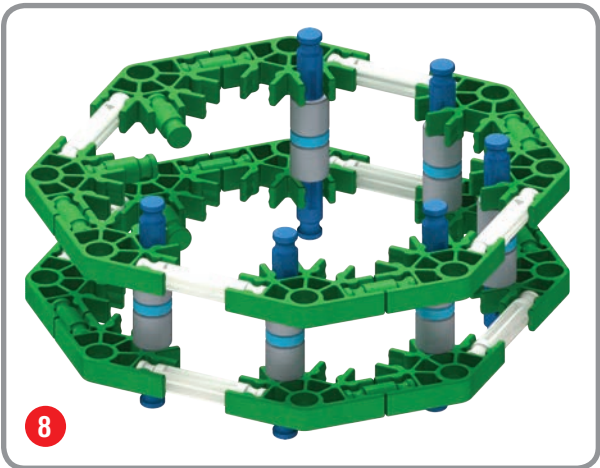

8

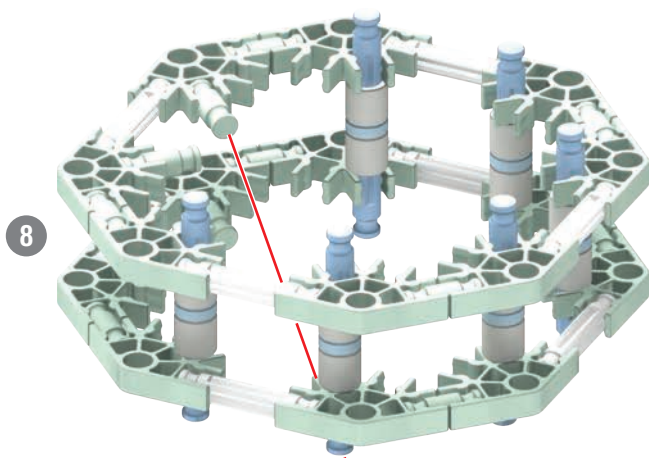

8

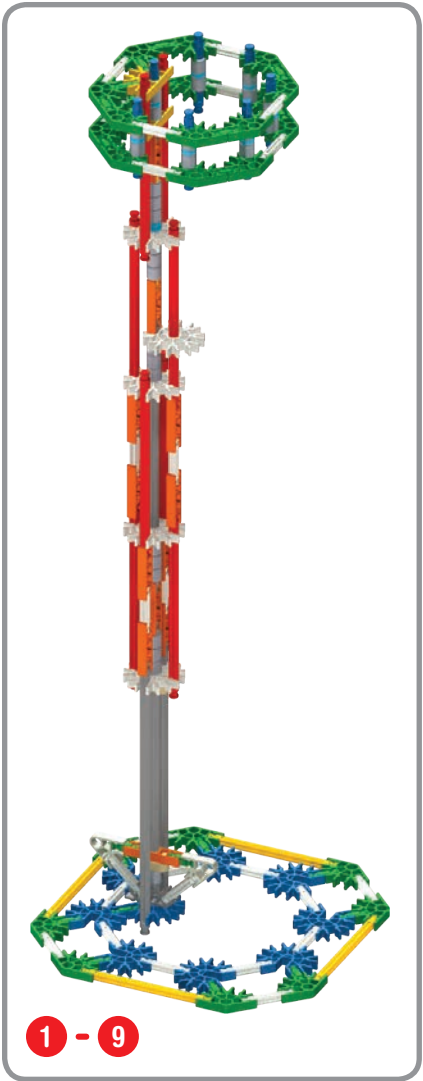

1 - 9

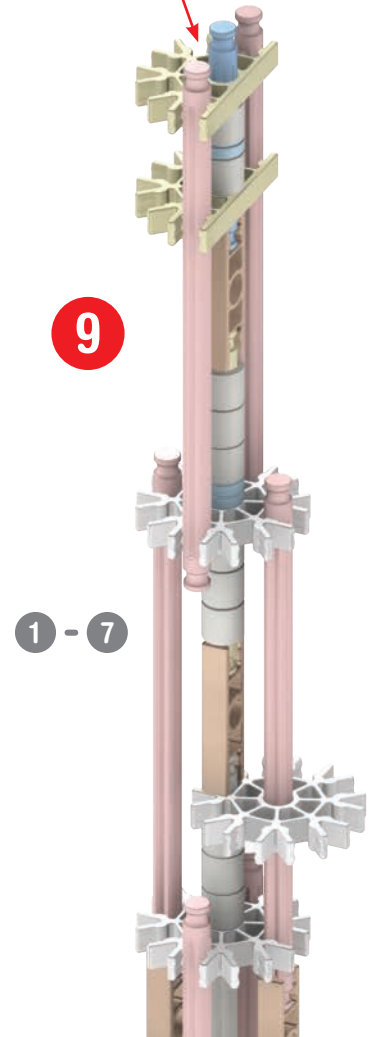

9

1 - 7

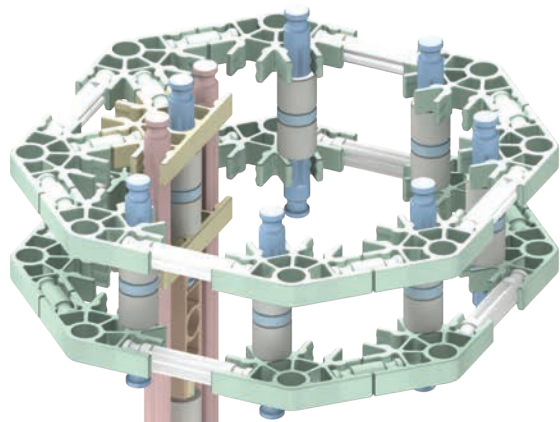

1 - 9

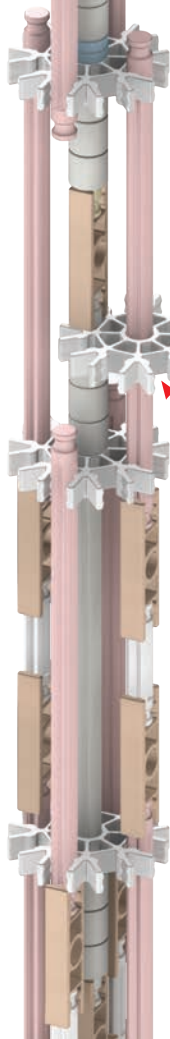
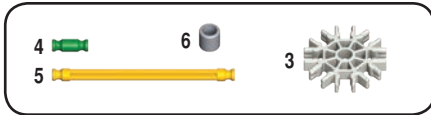

10

10

11

11

6

12

12

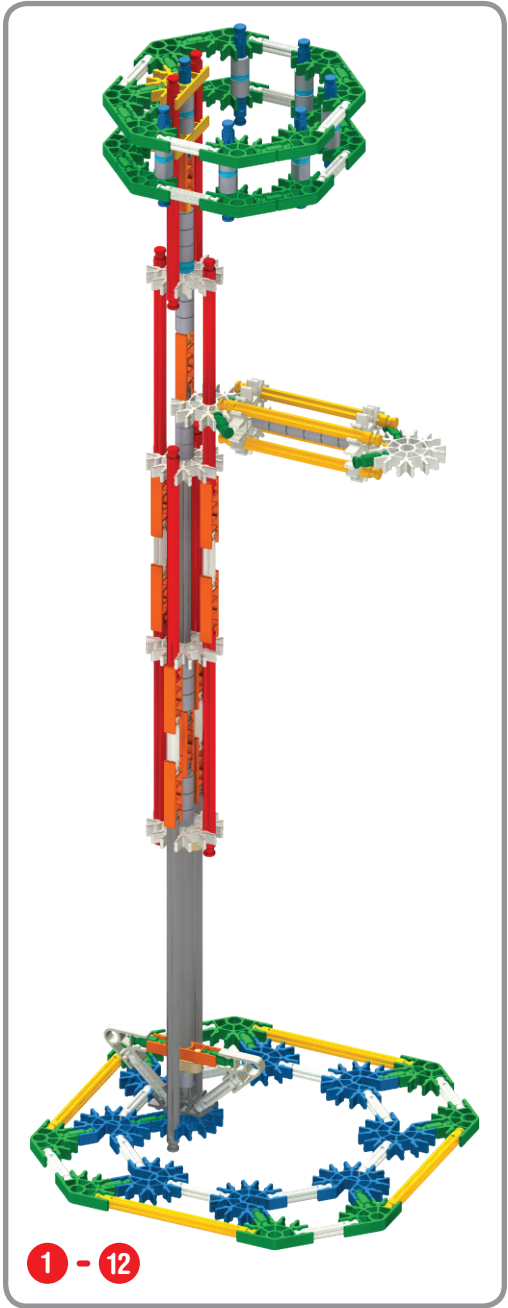

1 - 12

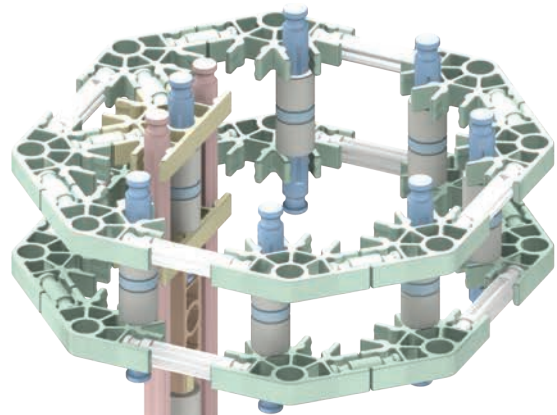

- | | | | |
|---|--|---|--|
| 6 | | 4 | |
| 4 | | | |
| 2 | | | |
| 1 | | | |
| 2 | | 2 | |

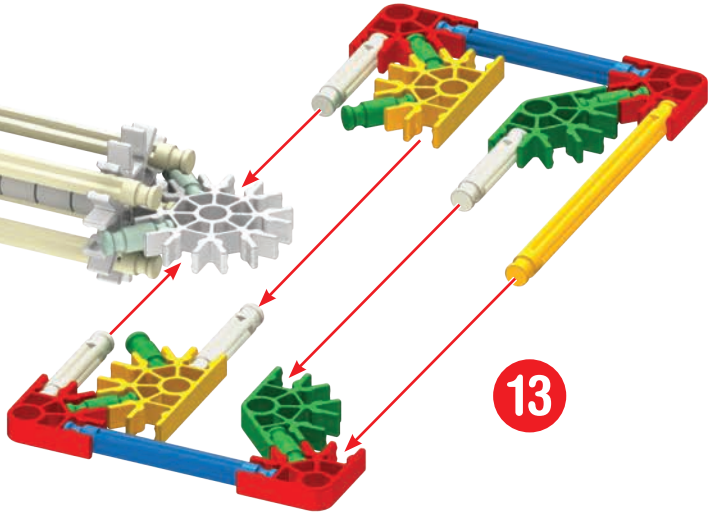
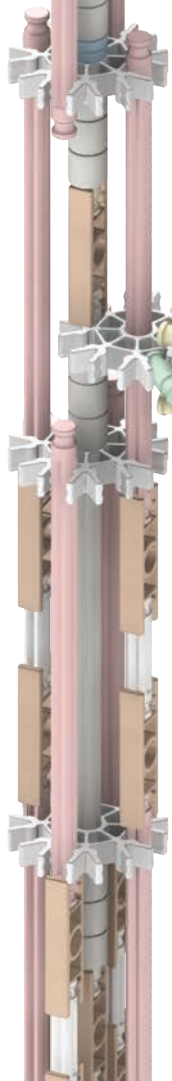

1 - 12



1 - 13

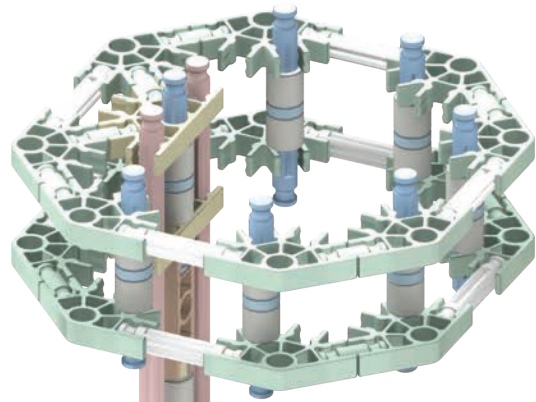

- 4
- 2
- 2
- 8
- 4
- 4

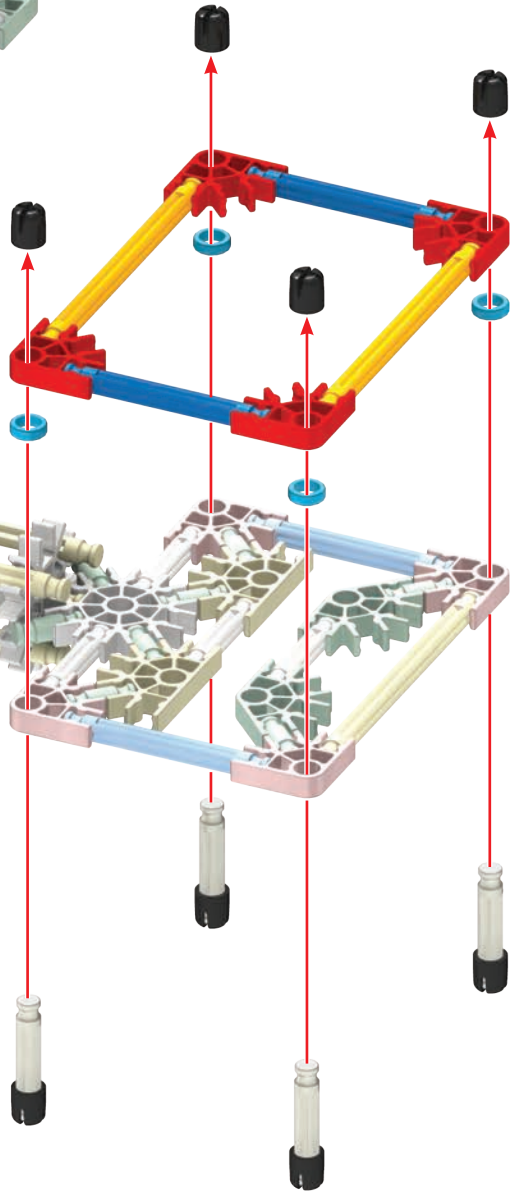

14

1 - 13



**Metal
Detector**

1 - 14

Picture Frame

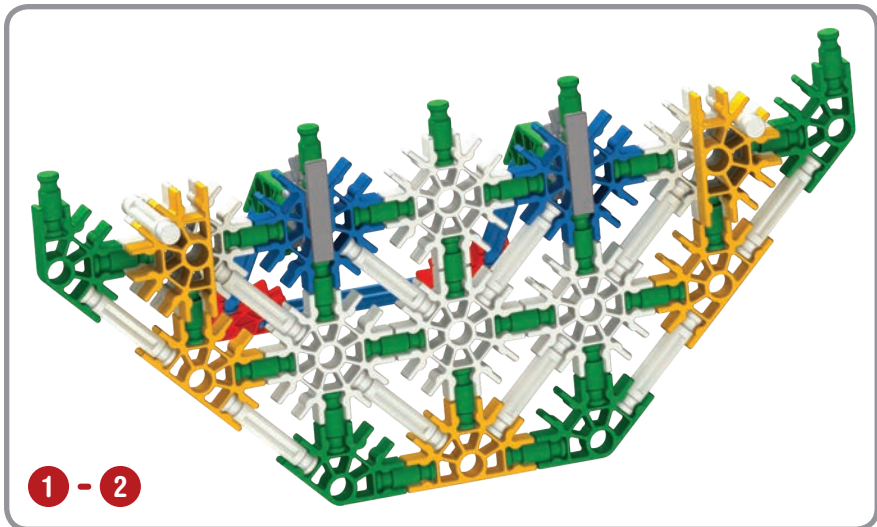
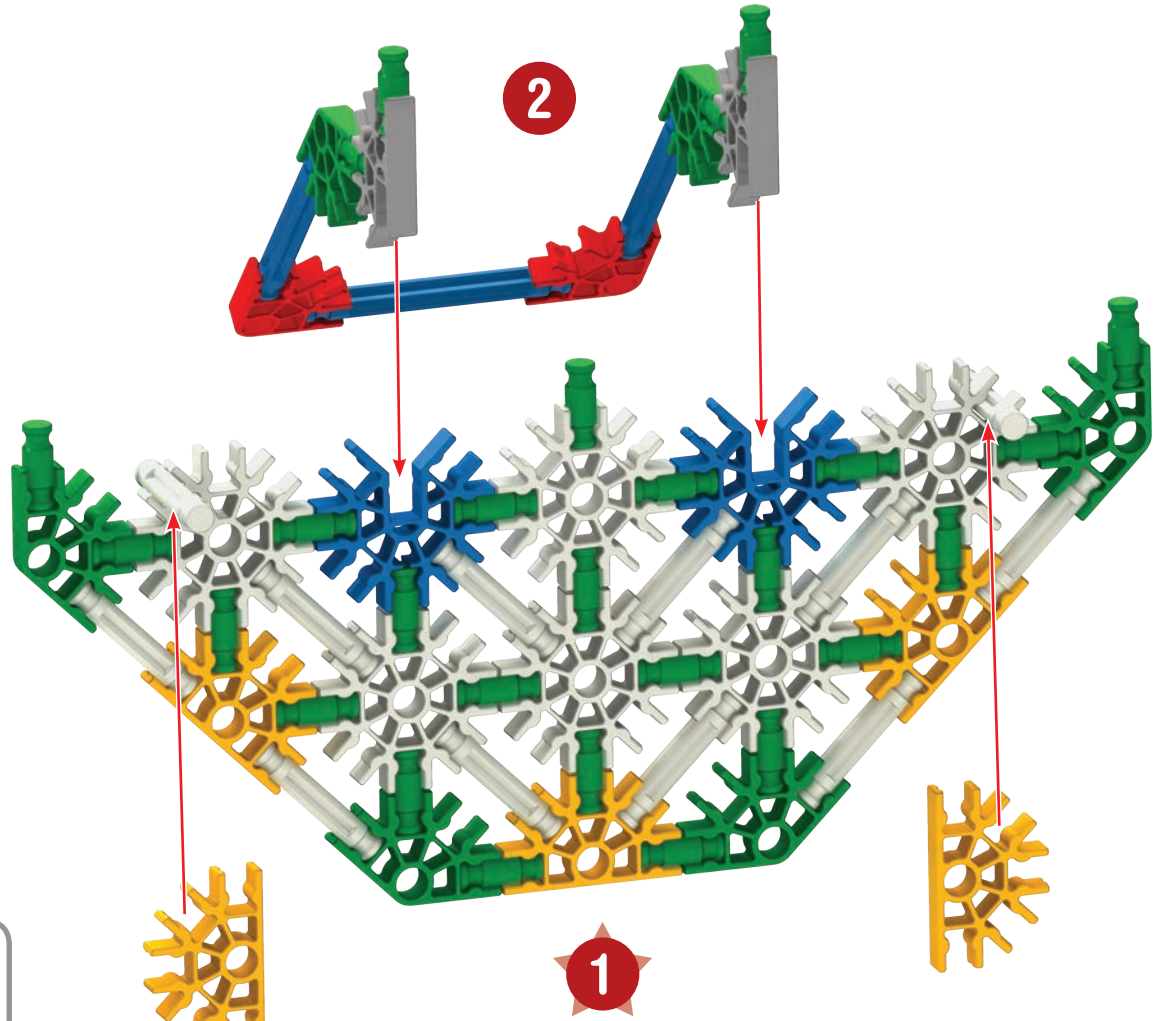
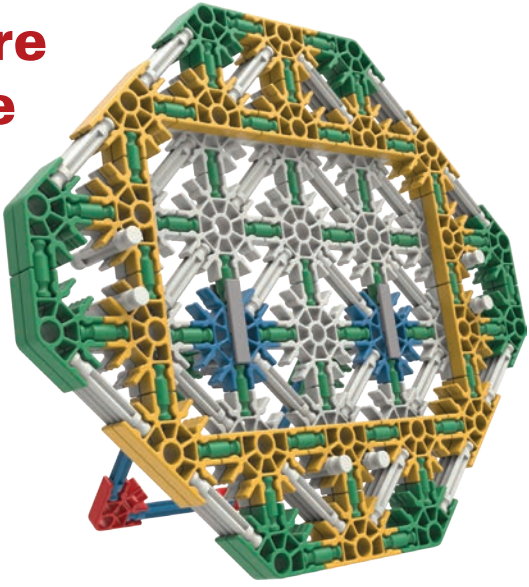

27		2		6		6	
12							
3							
5		2		2			

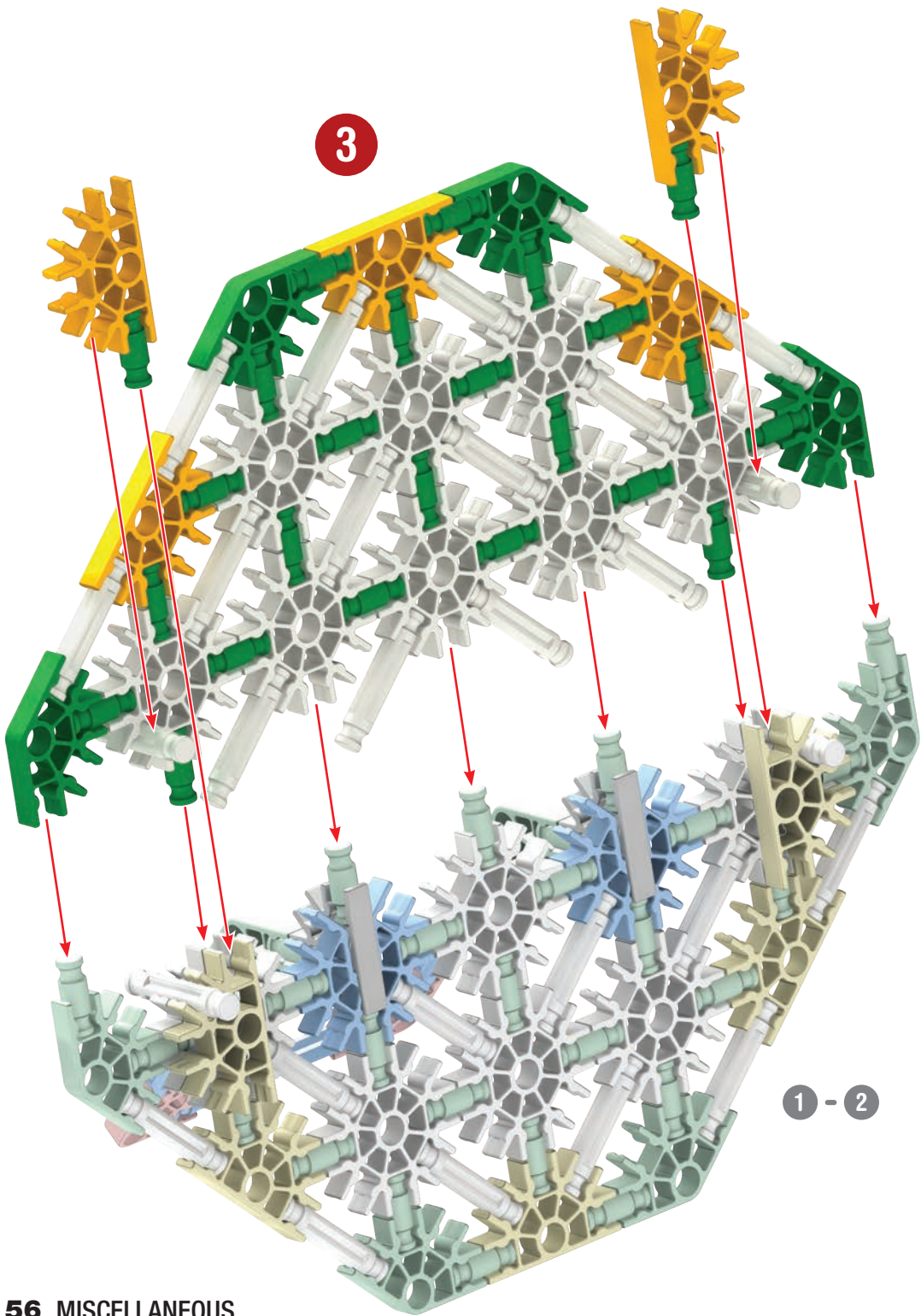

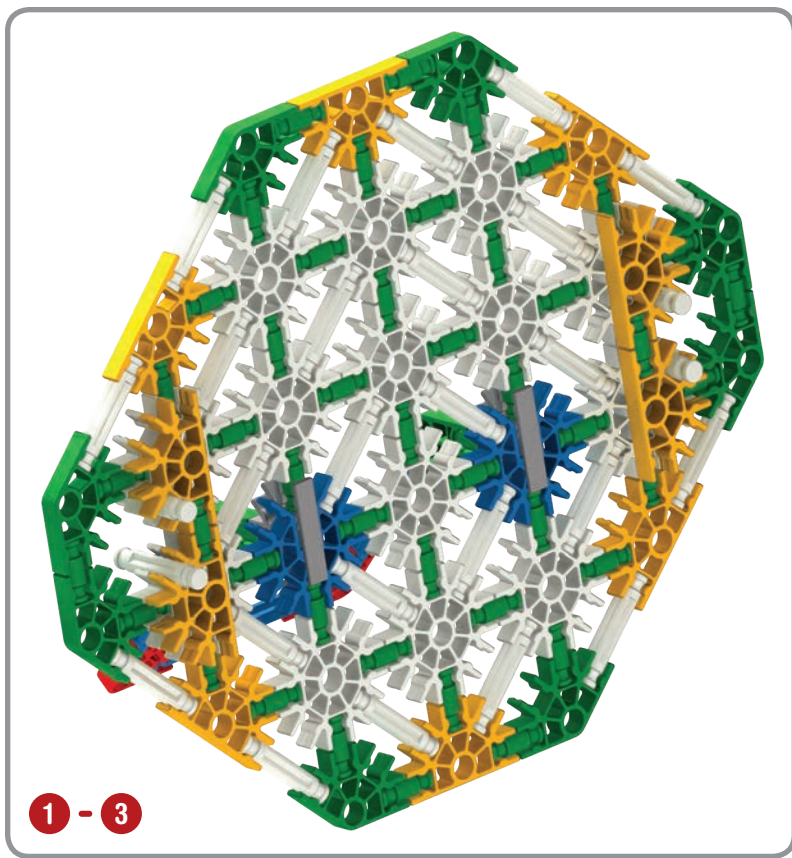

24		8	
16		4	
4		5	

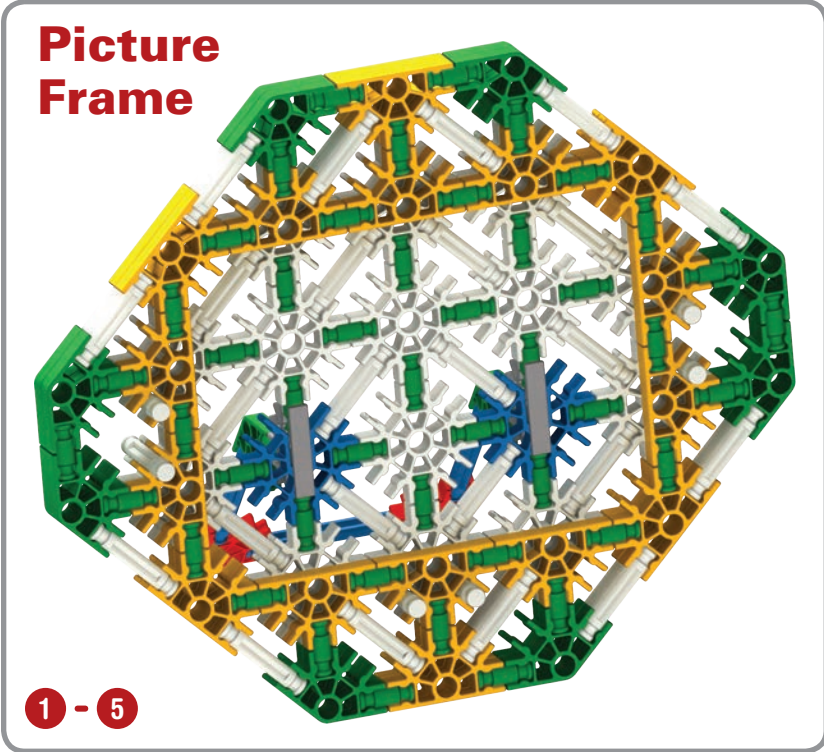
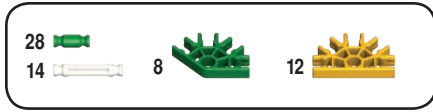
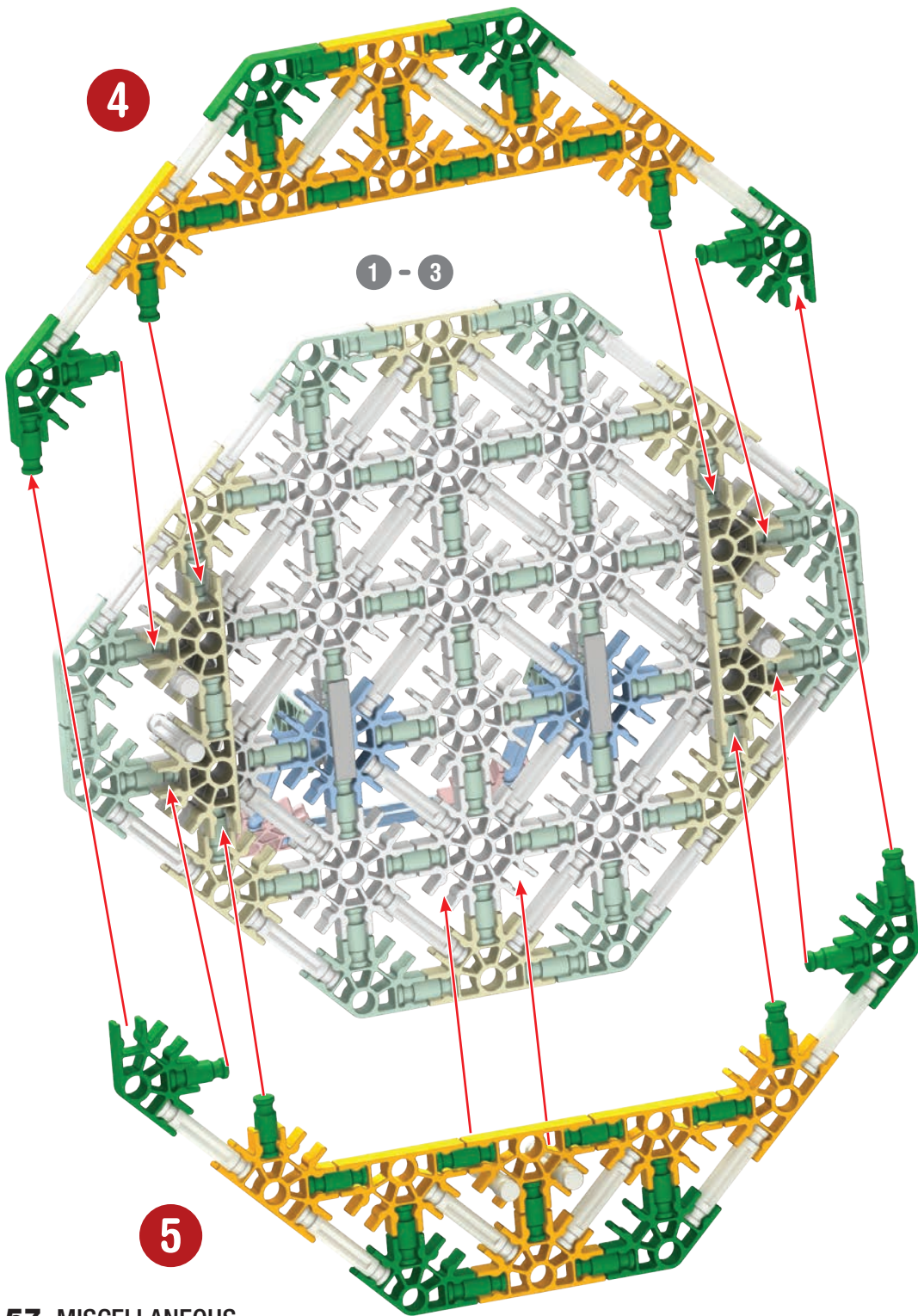

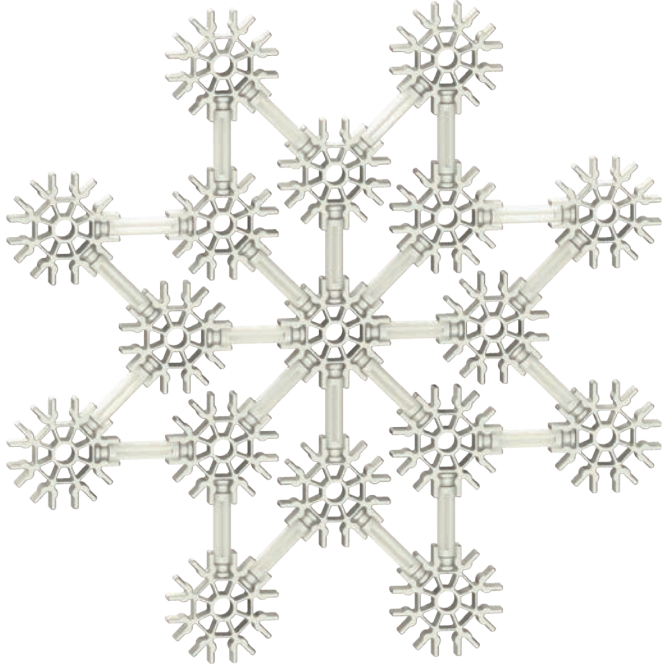

Snowflake



24 

17 

1

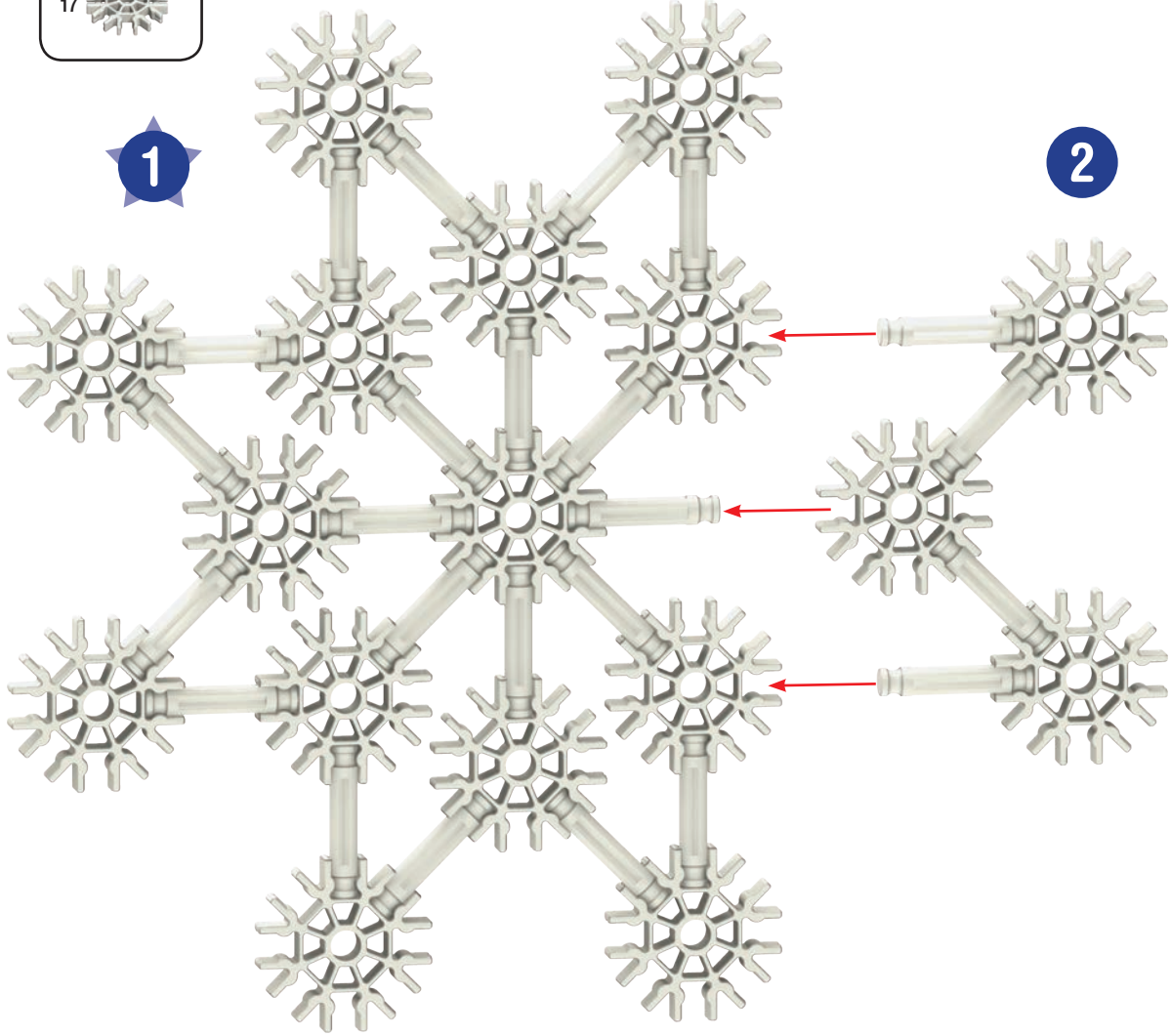

2



- | | | | | | | |
|---|--|---|--|---|--|--|
| 9 | | 1 | | 1 | | |
| 4 | | | | | | |
| 1 | | | | | | |
| 4 | | 4 | | 2 | | |

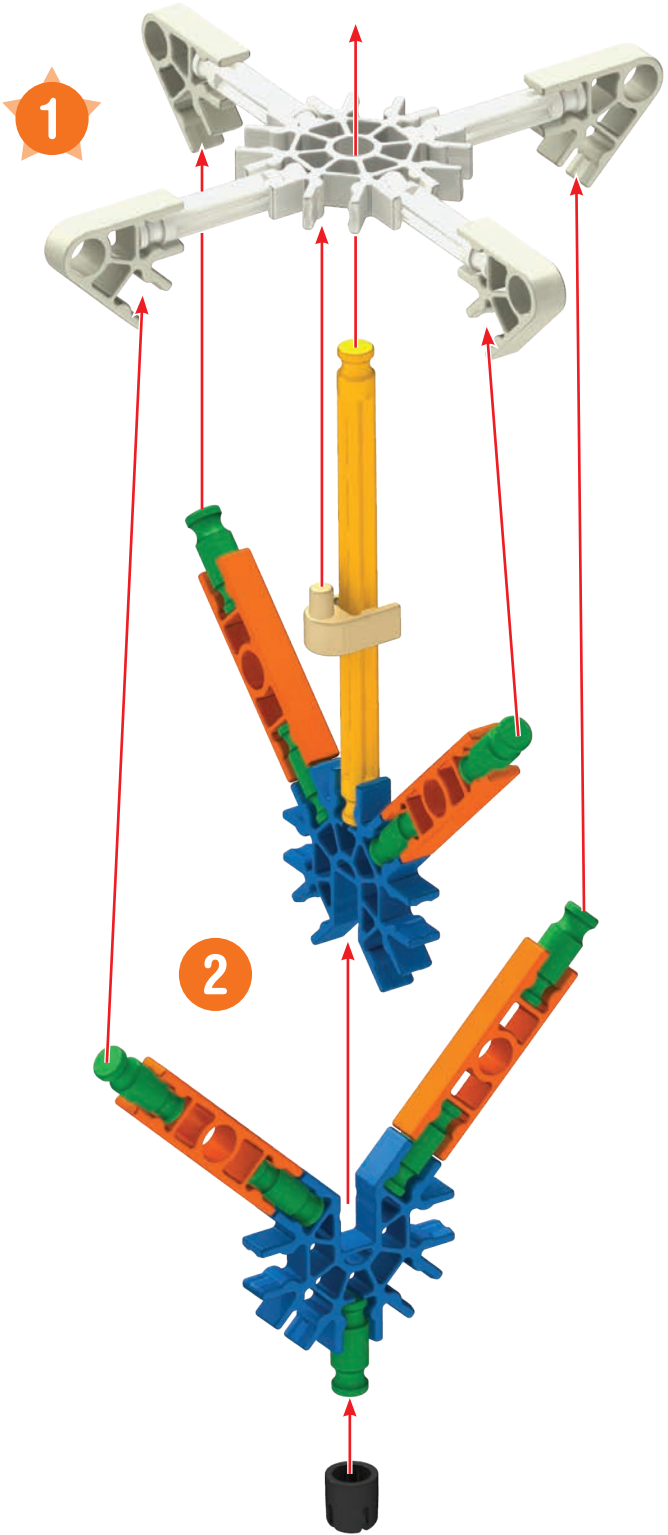

Starburst

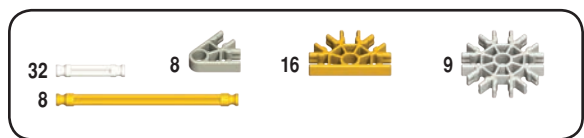
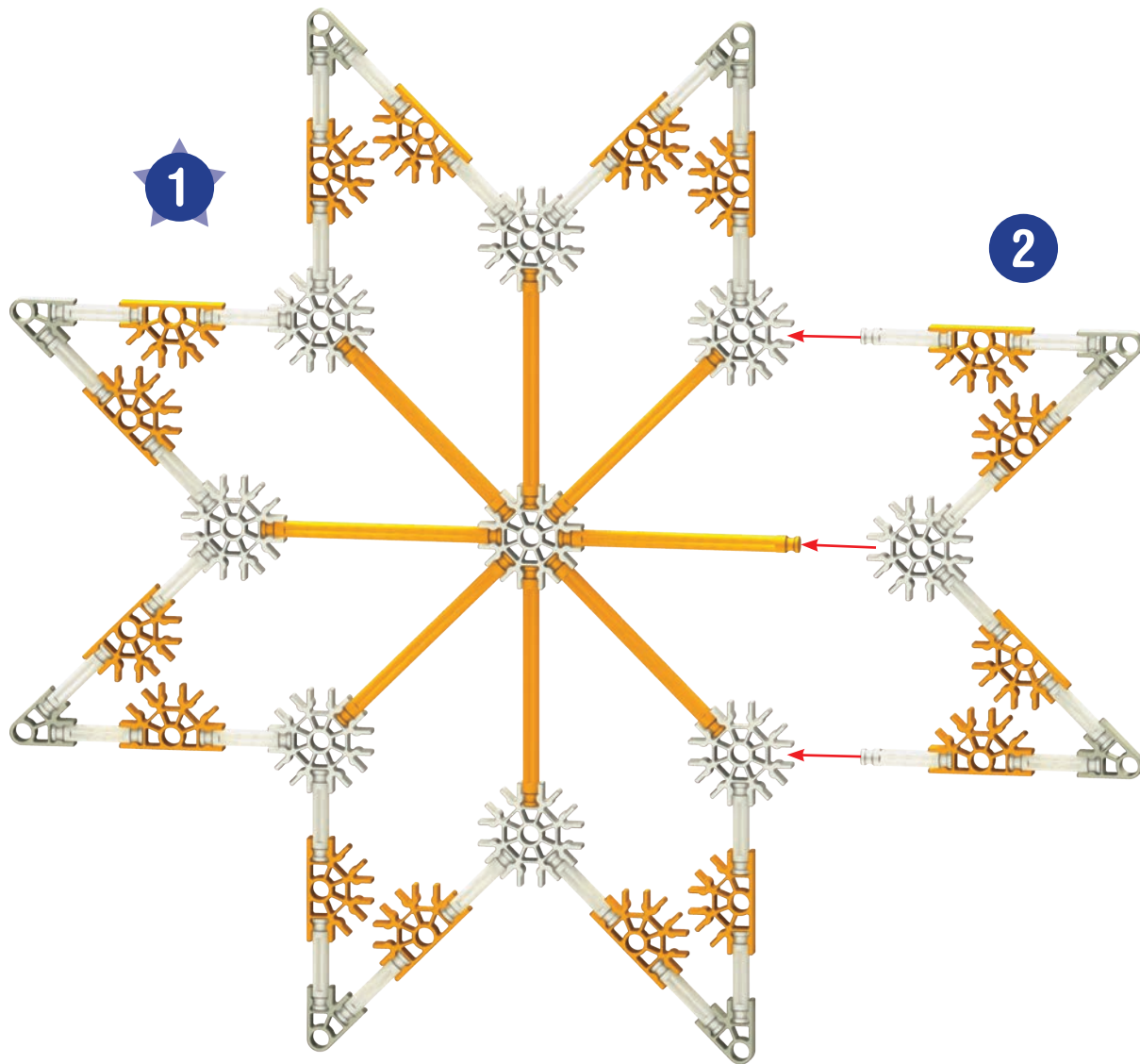
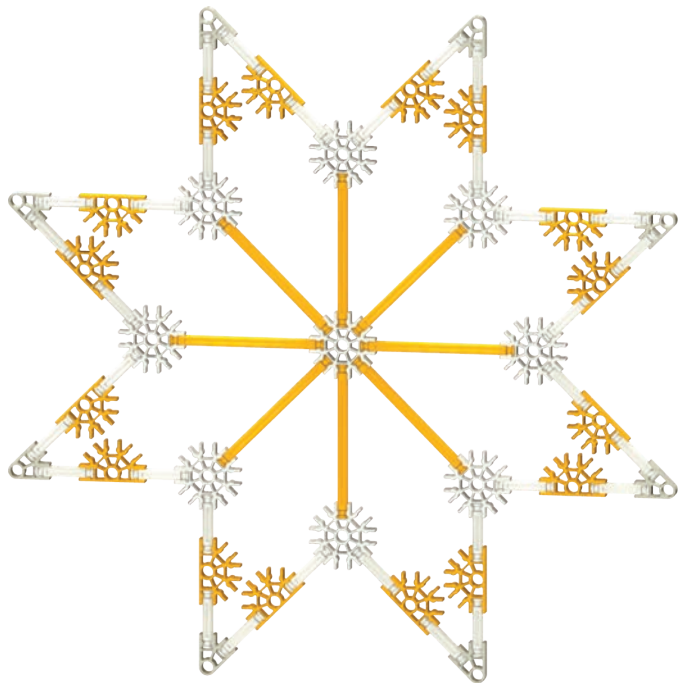
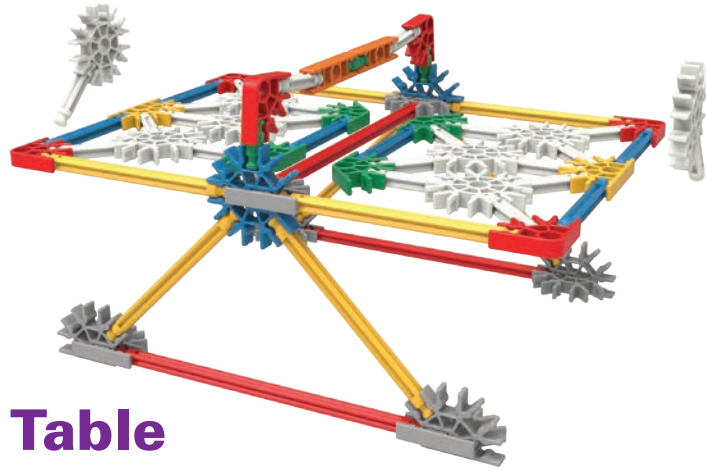
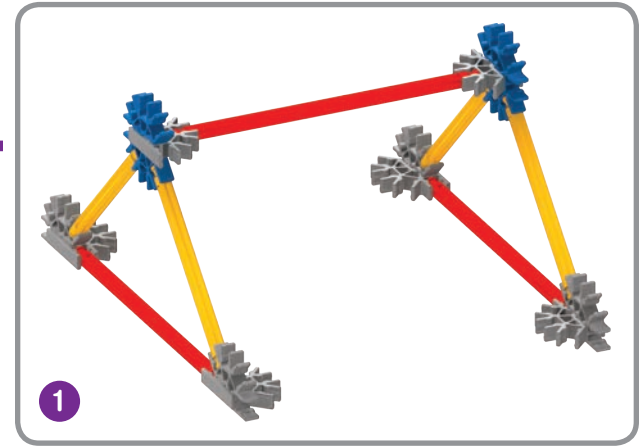
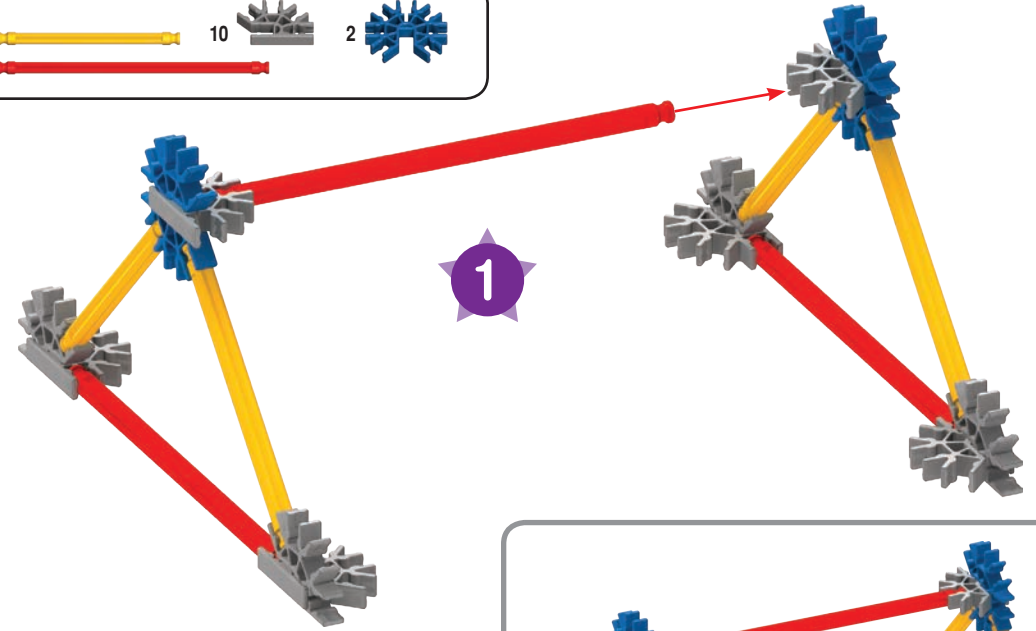

Table Tennis



- 4 10 2
- 3



- 9 2
- 3
- 2
- 2
- 1
- 3

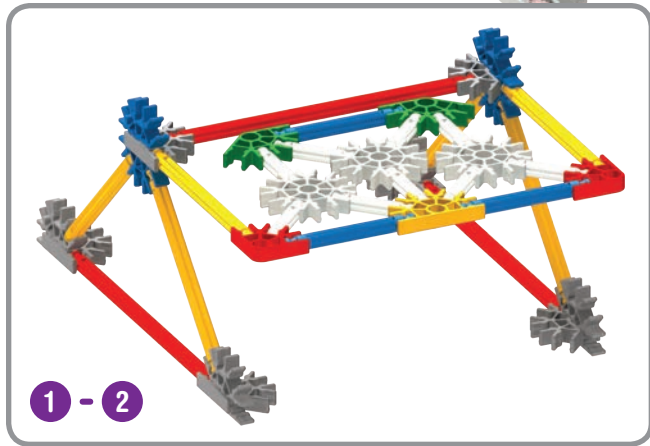
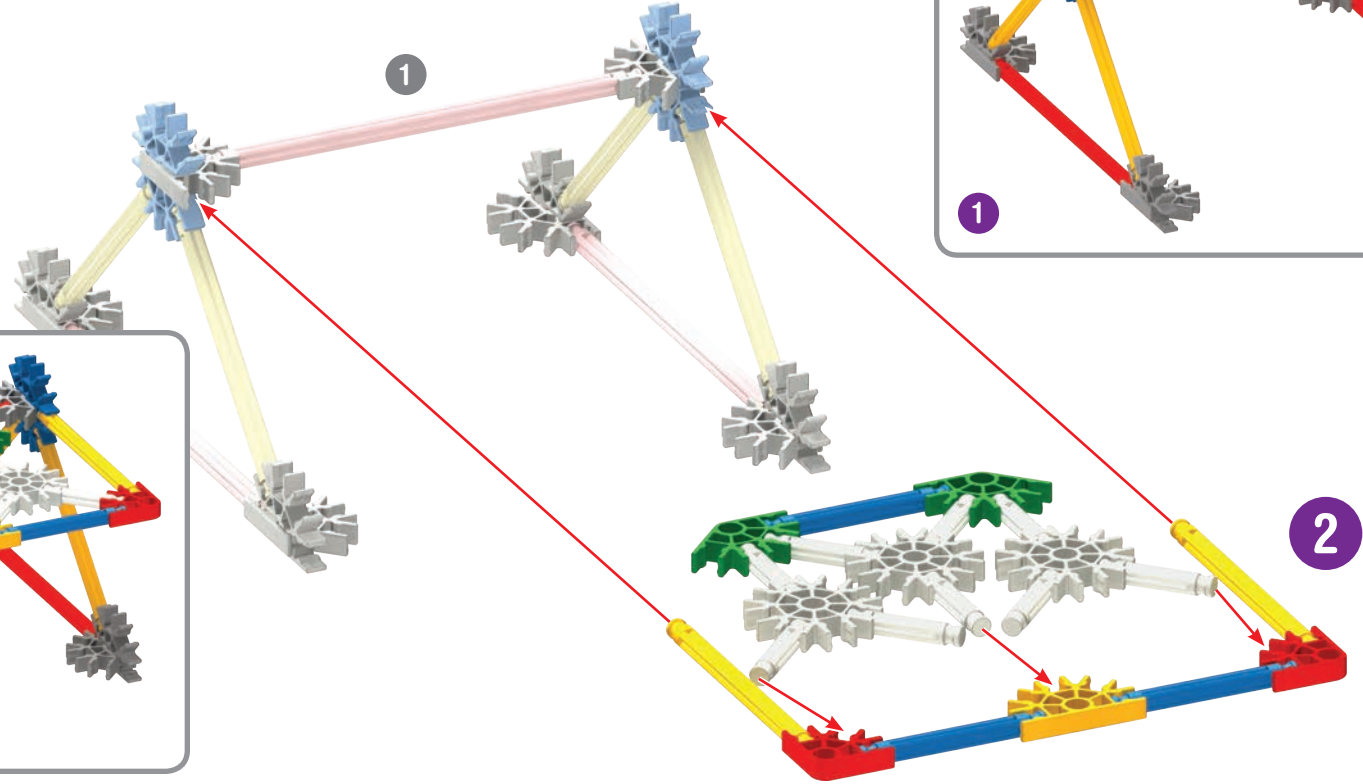

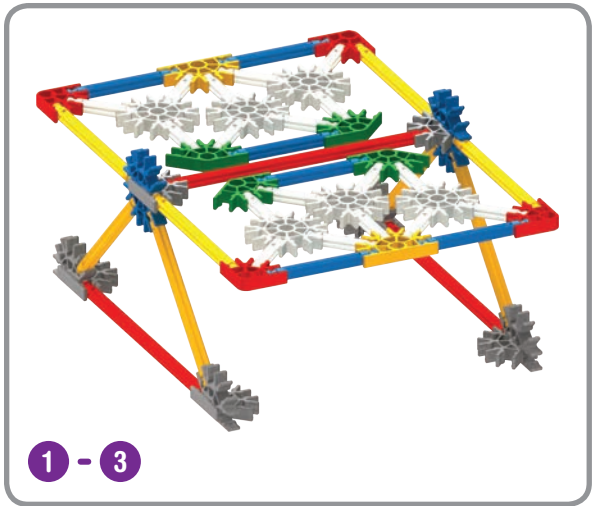
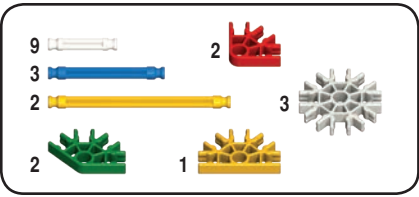
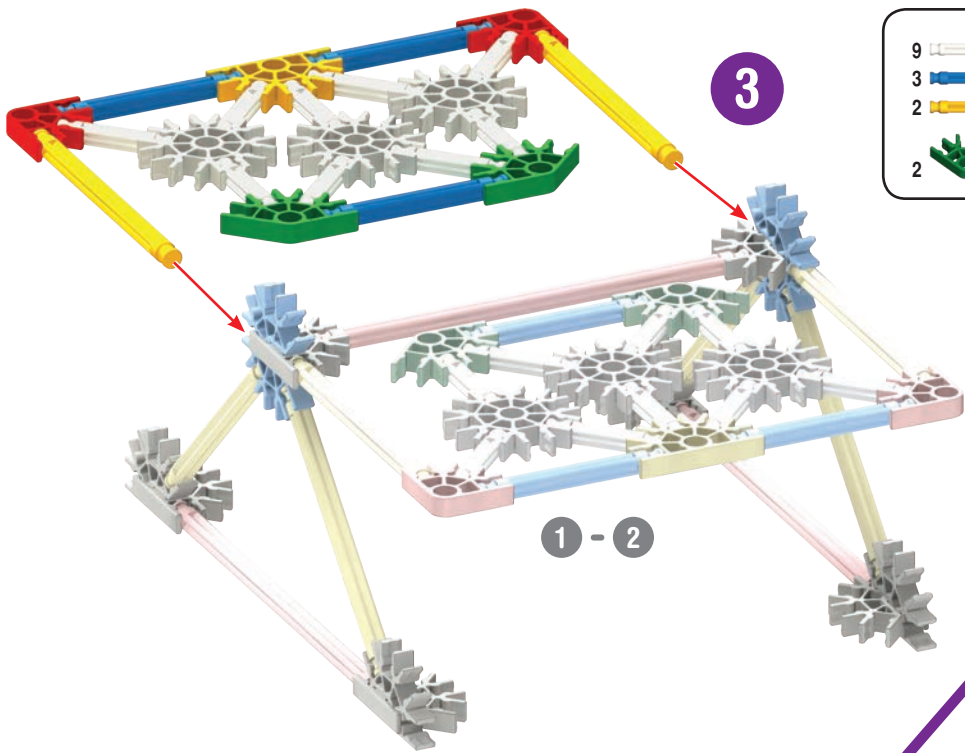

1 - 2

1 - 3

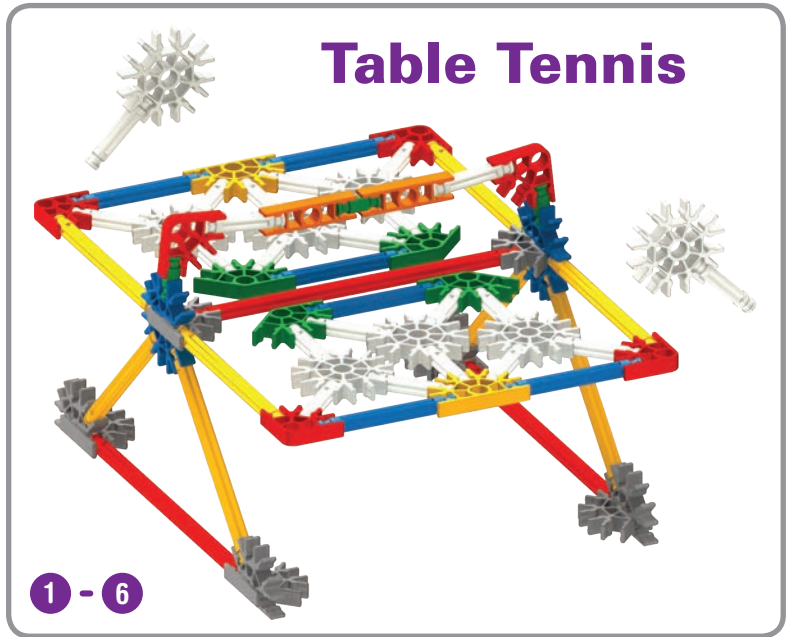

1 - 6

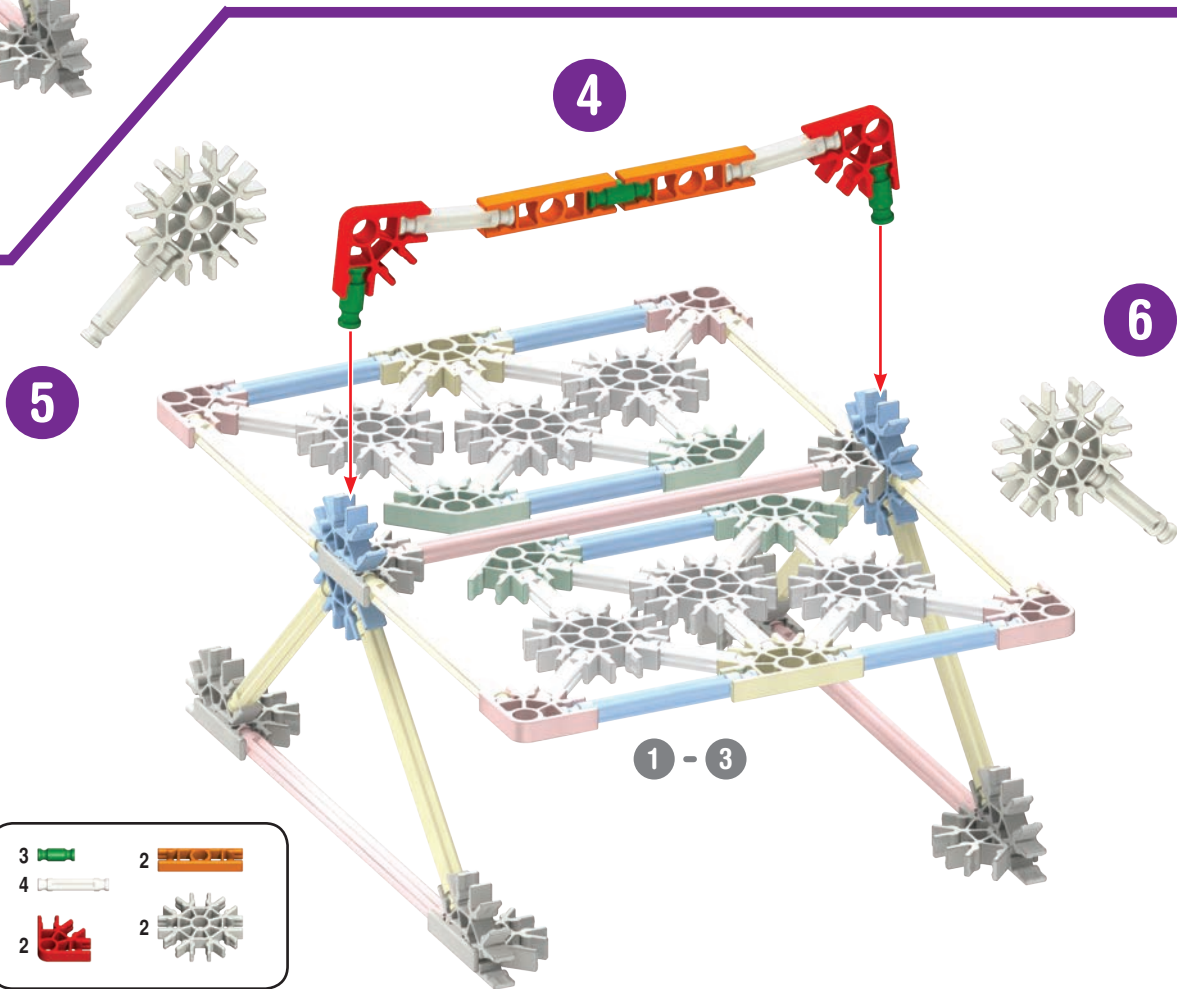

5

4

6

1 - 3

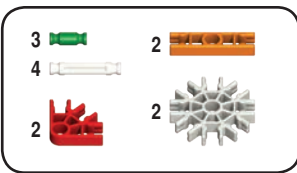

Telephone



12		2		2	
6					
6					
2					
1					
3		10		4	

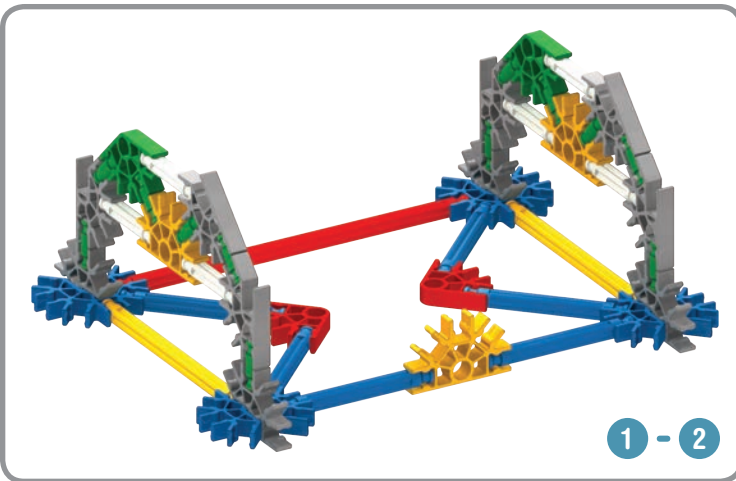
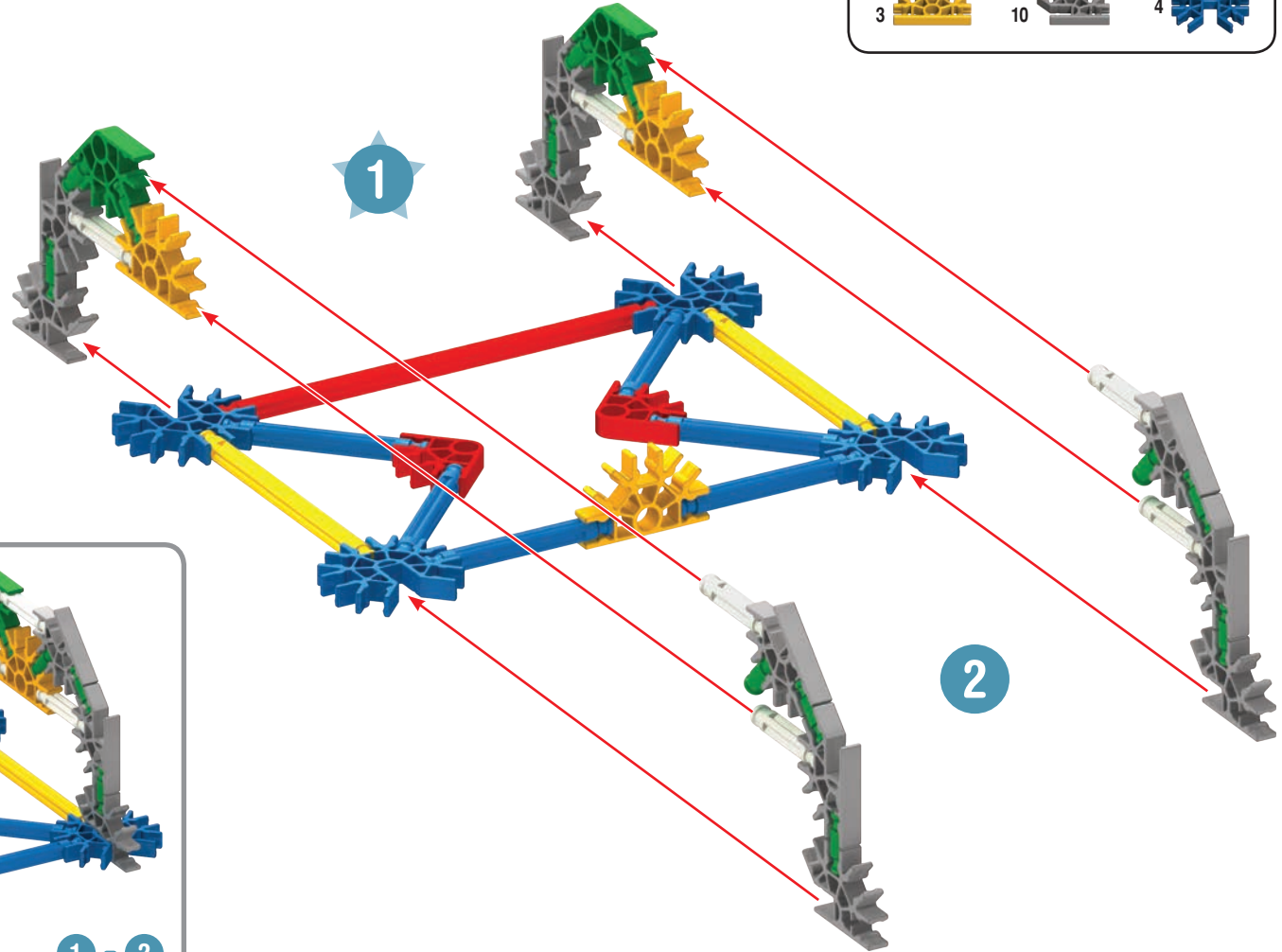

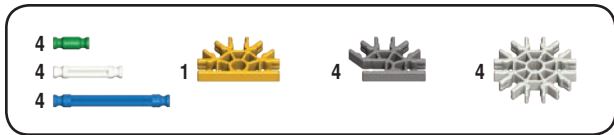
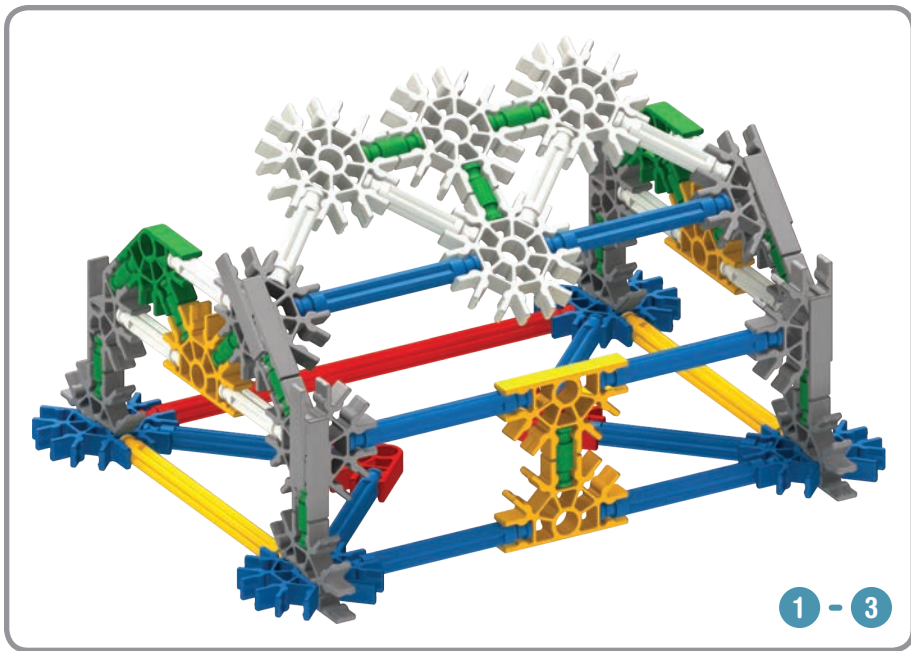



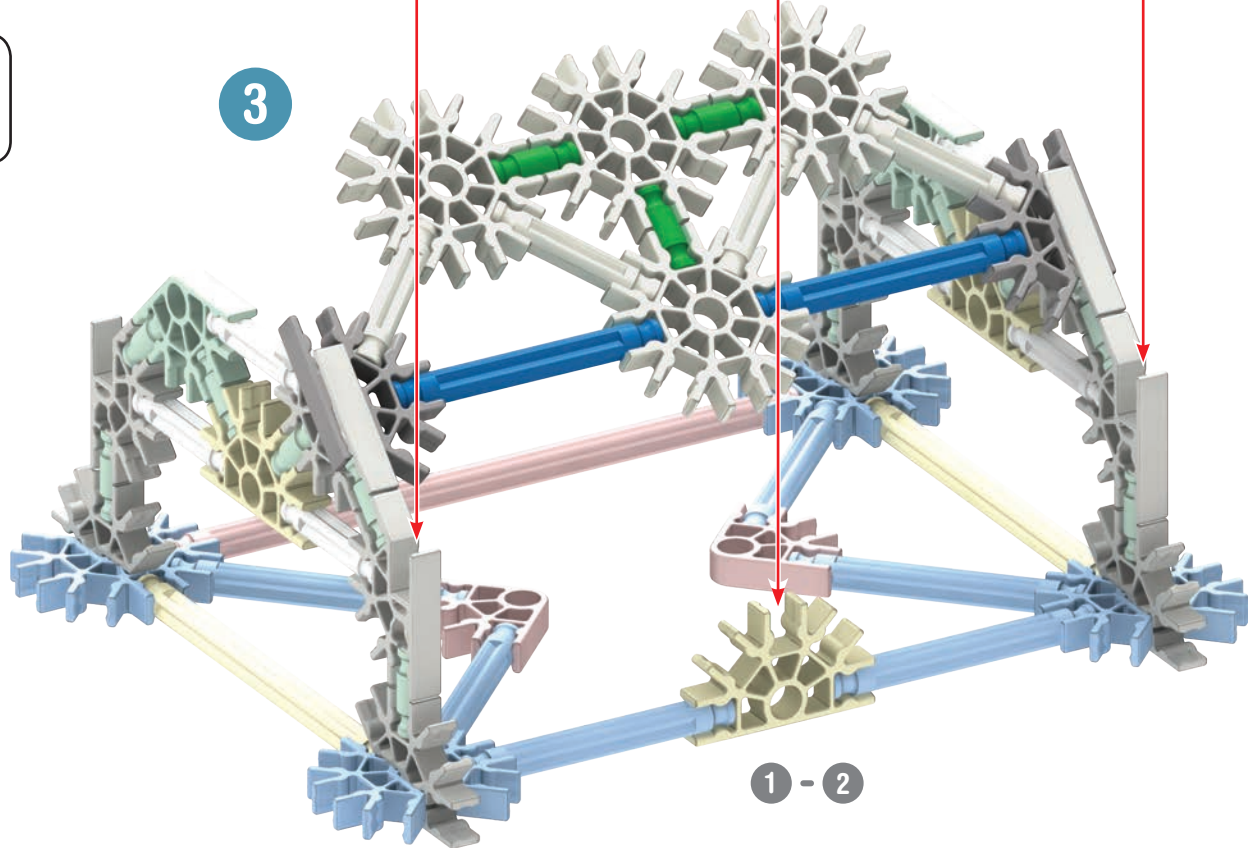
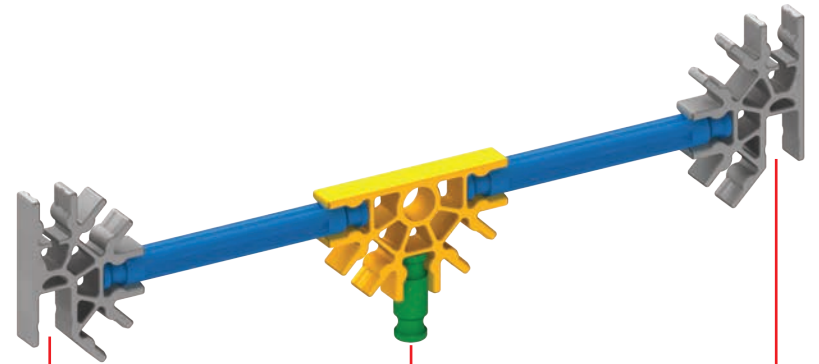

3

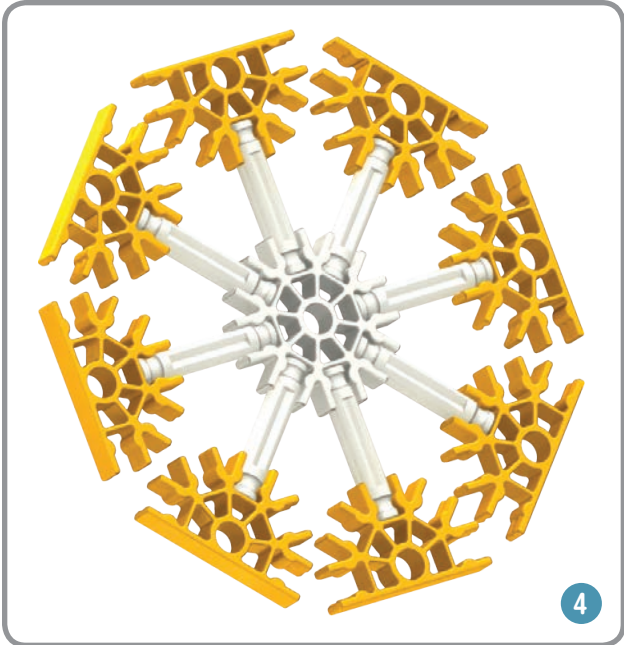
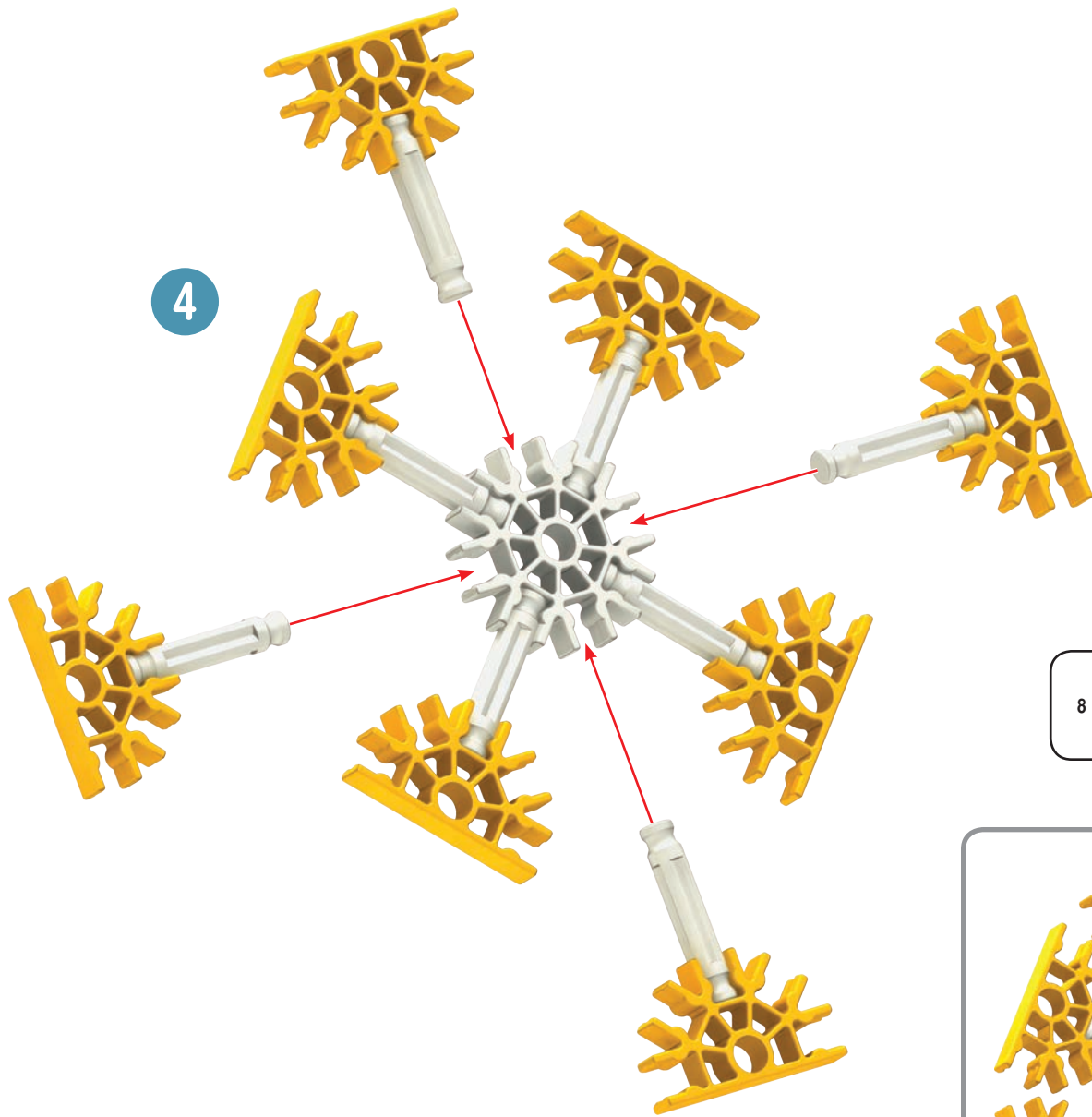

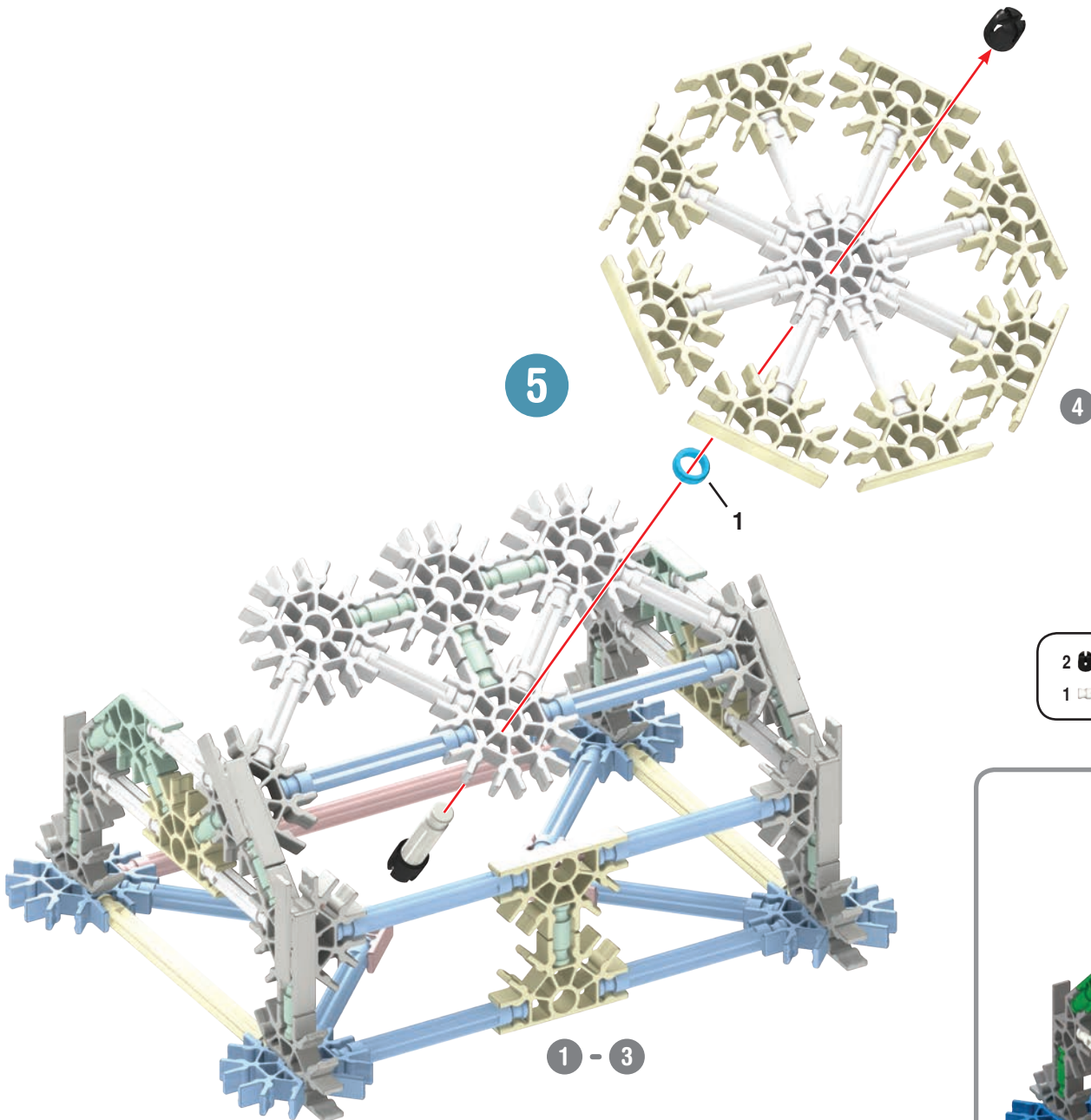
1 - 2





- 2 
- 1 
- 1 

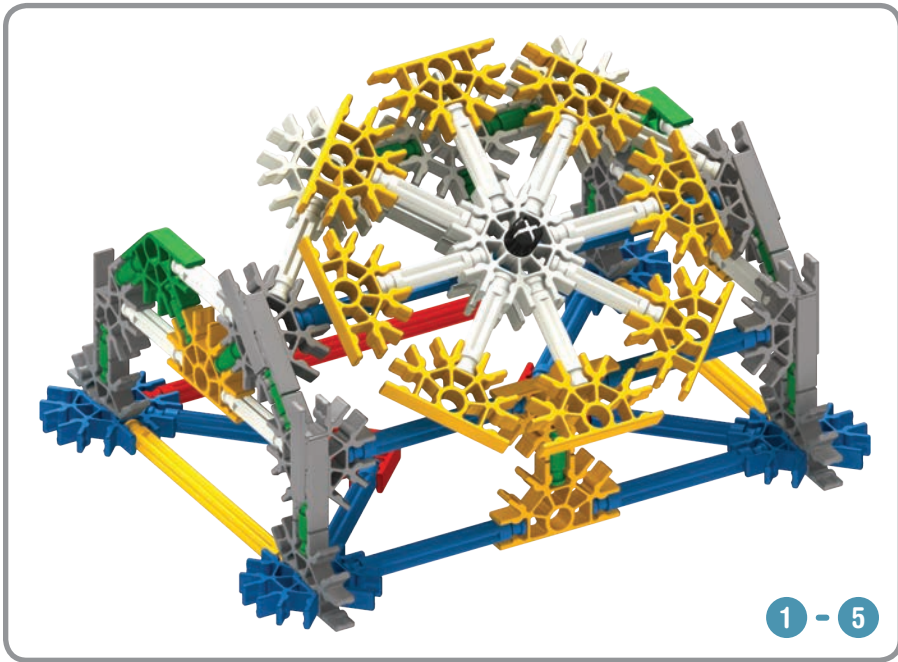

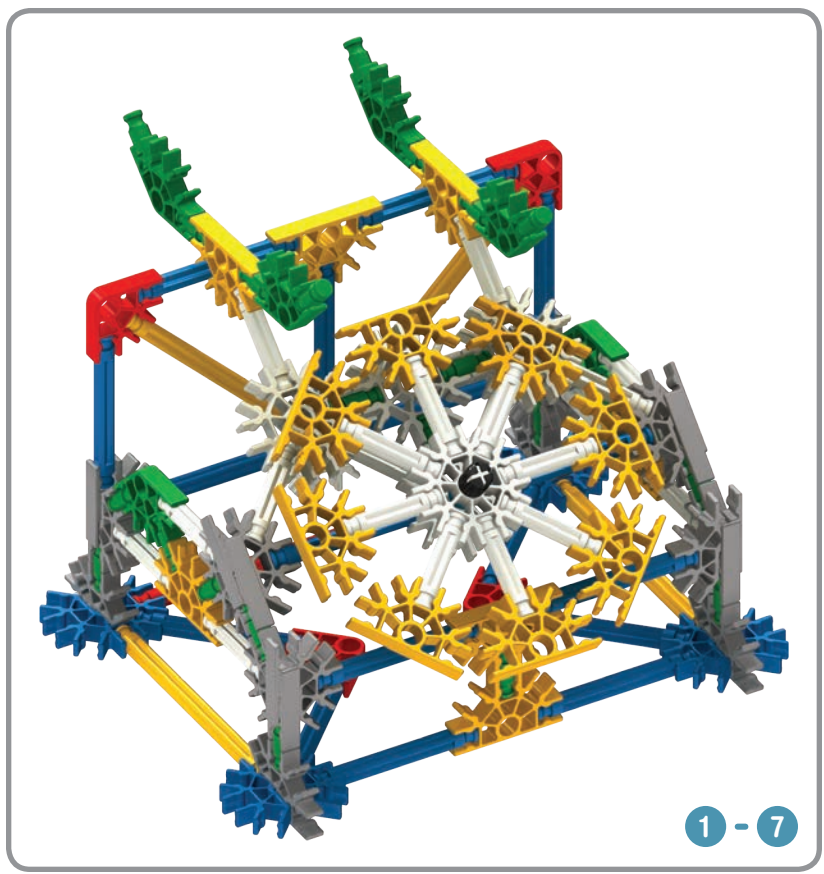
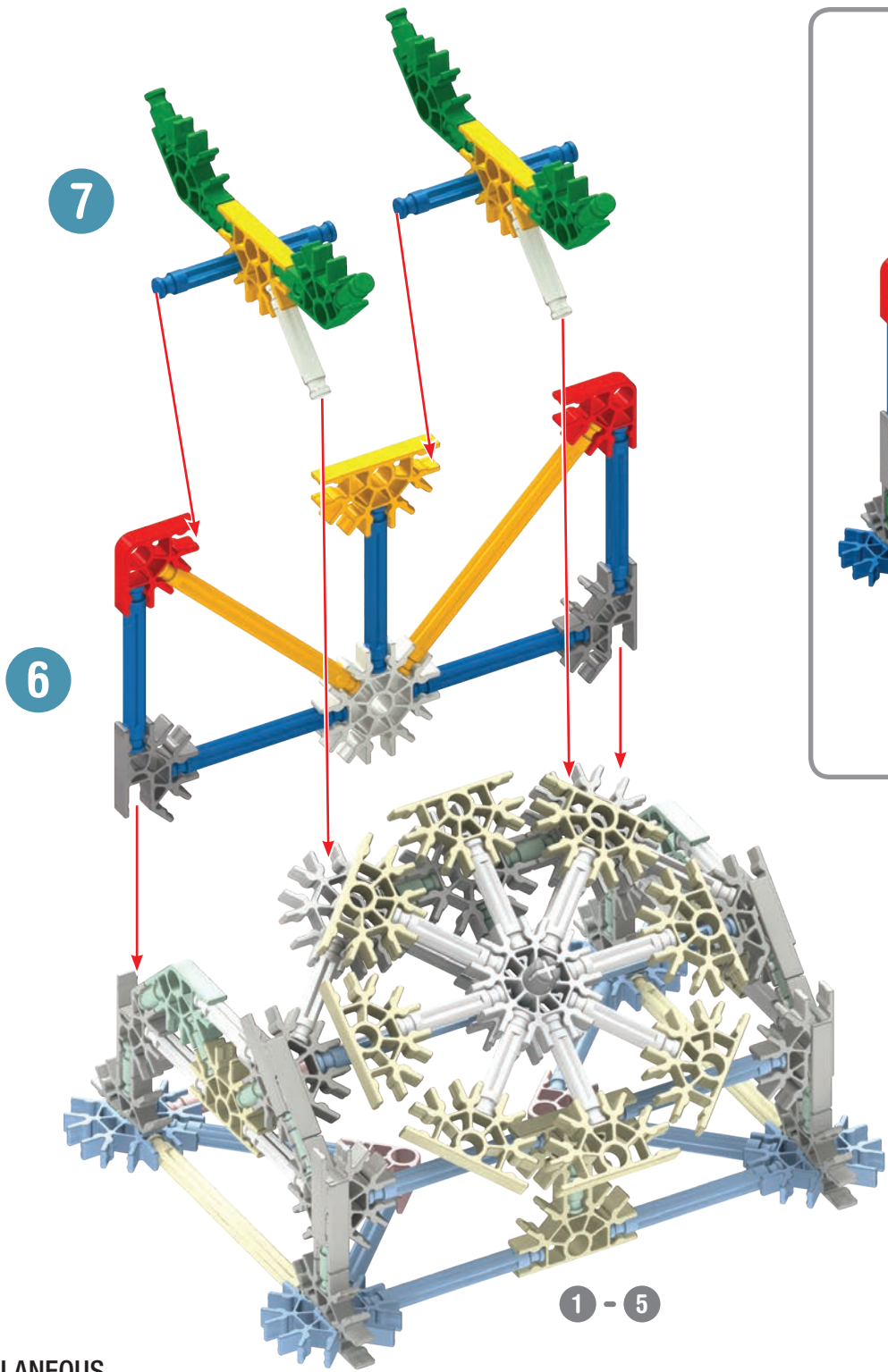

- | | | | | | |
|---|--|---|--|---|--|
| 8 | | 2 | | 4 | |
| 2 | | 7 | | 2 | |
| 3 | | 2 | | 1 | |

x2

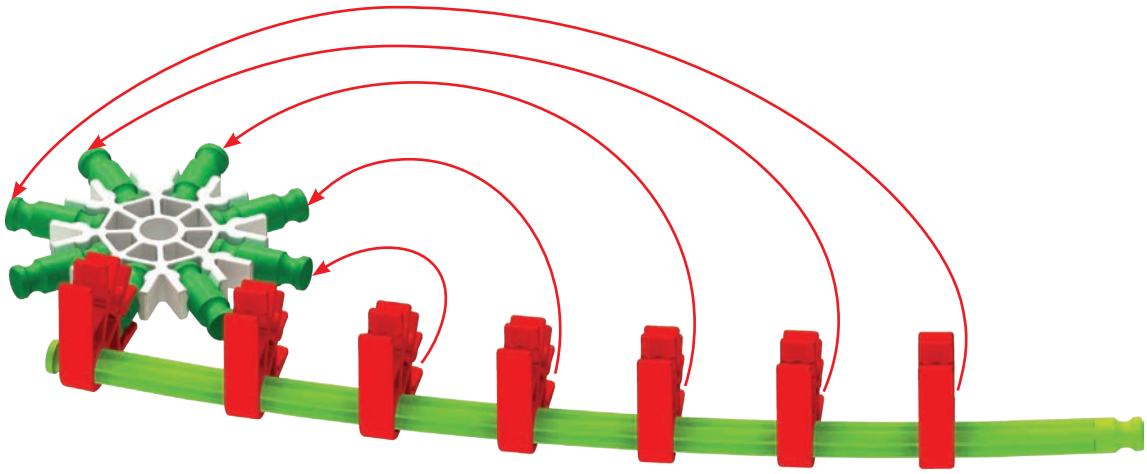
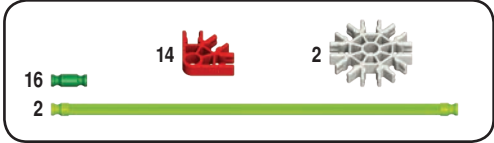

8

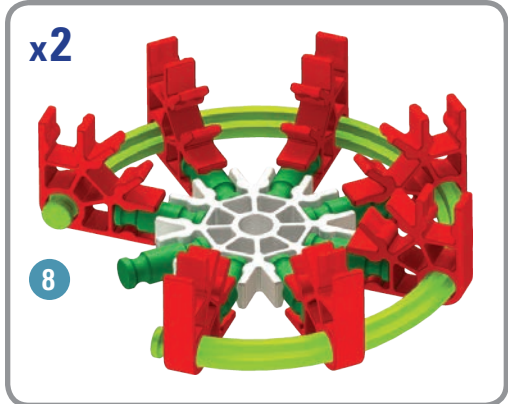

x2

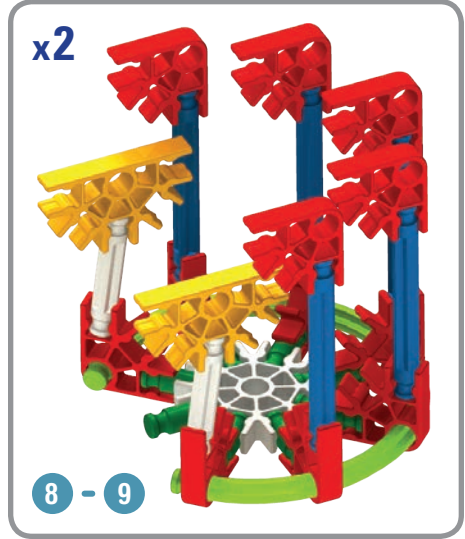
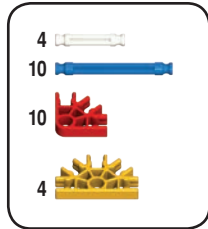
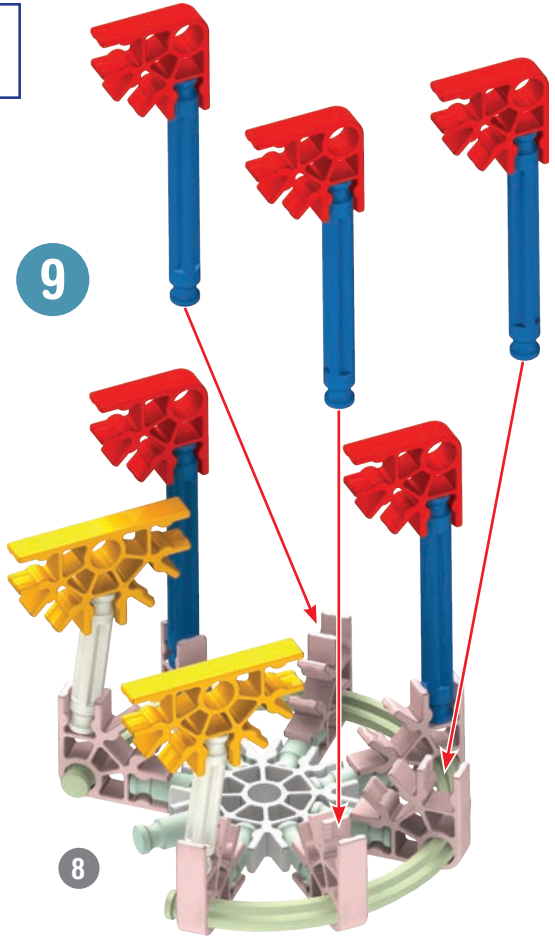

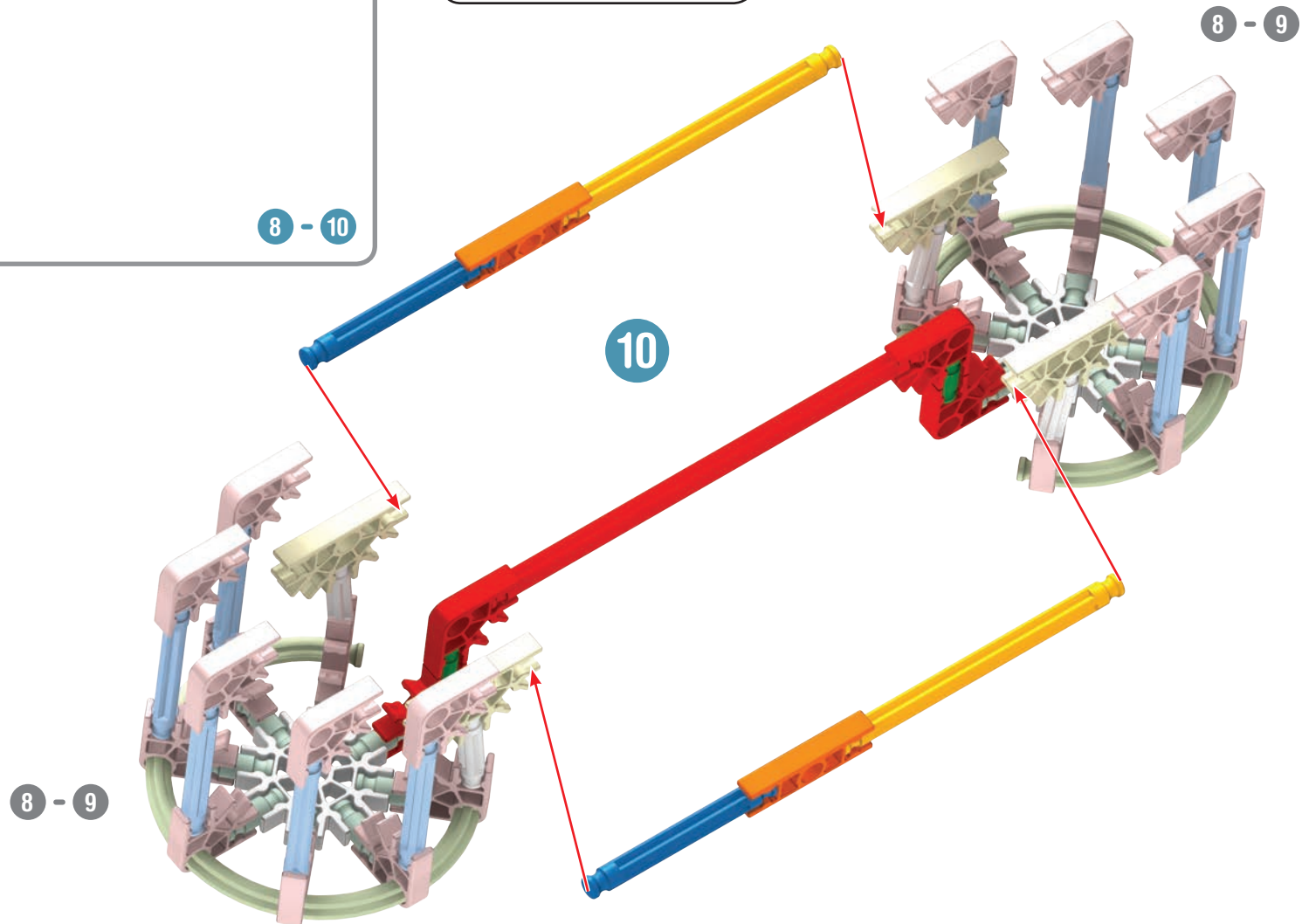
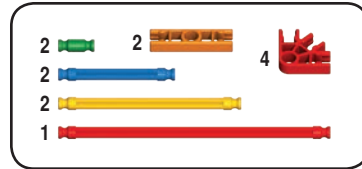
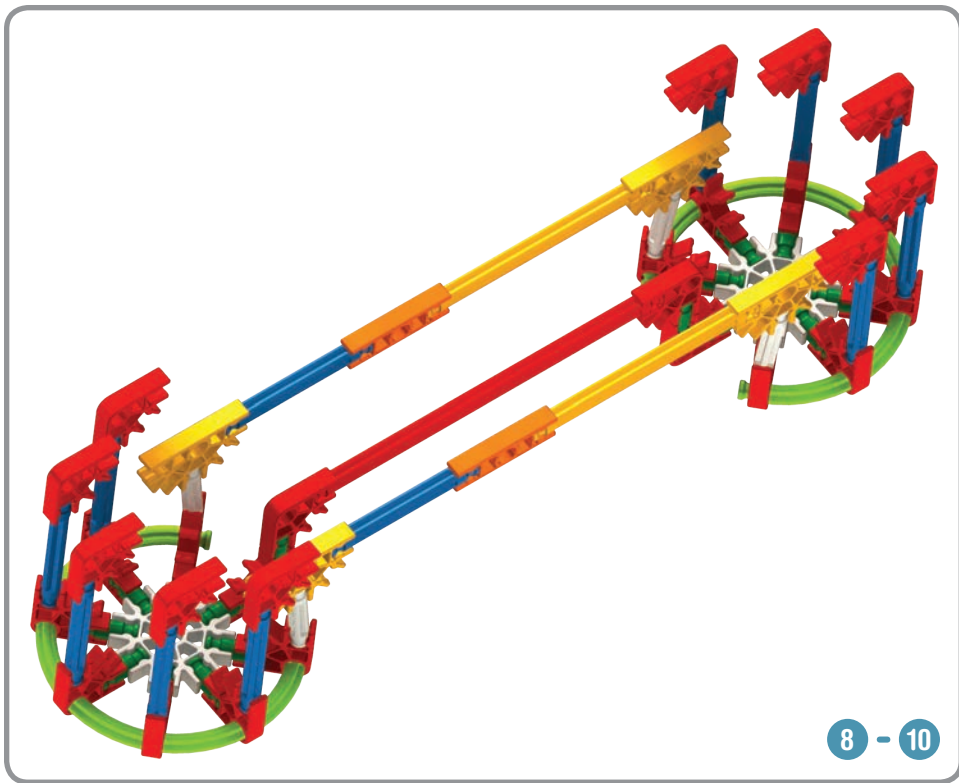

11

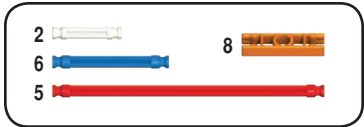
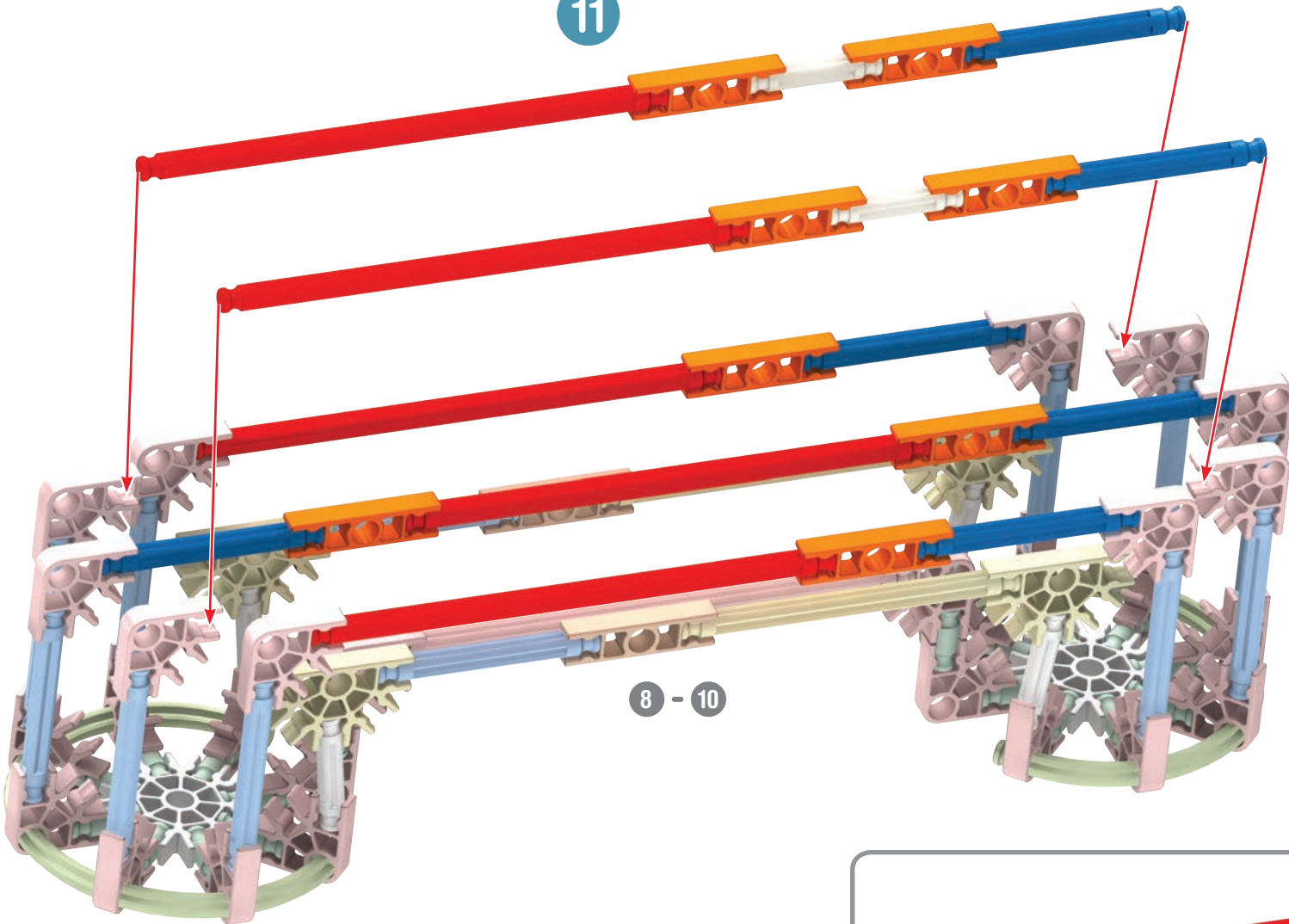

8 - 10



8 - 11

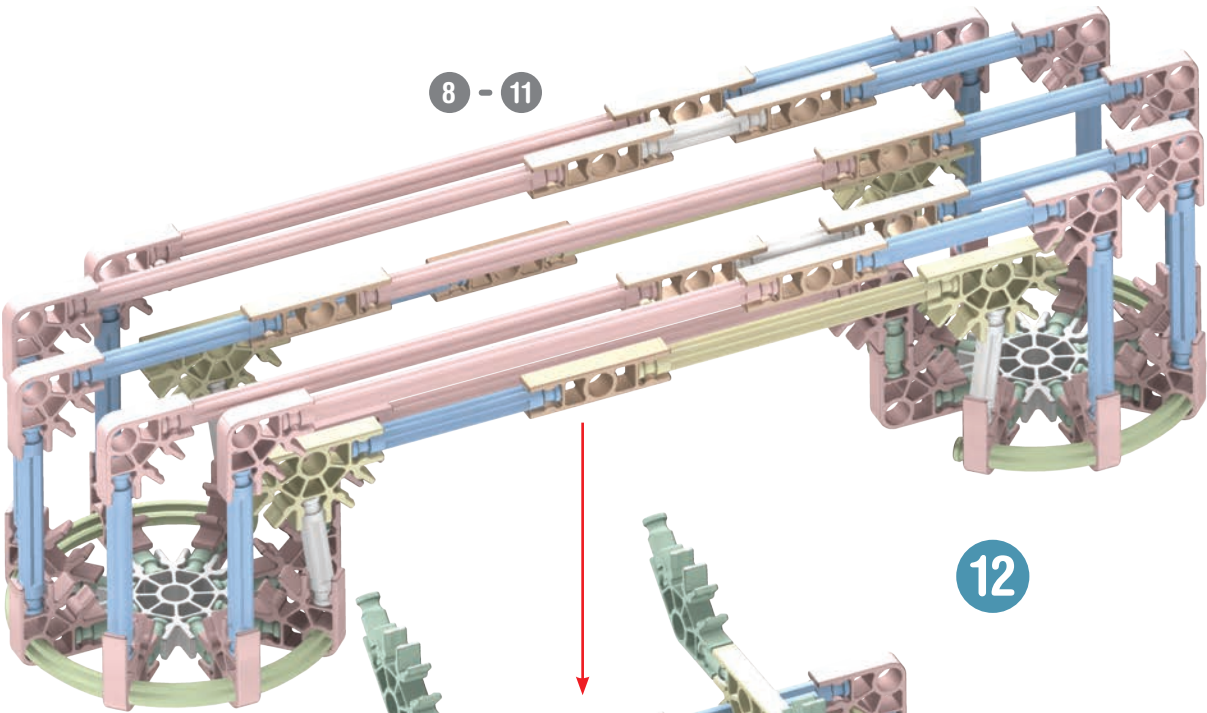

12

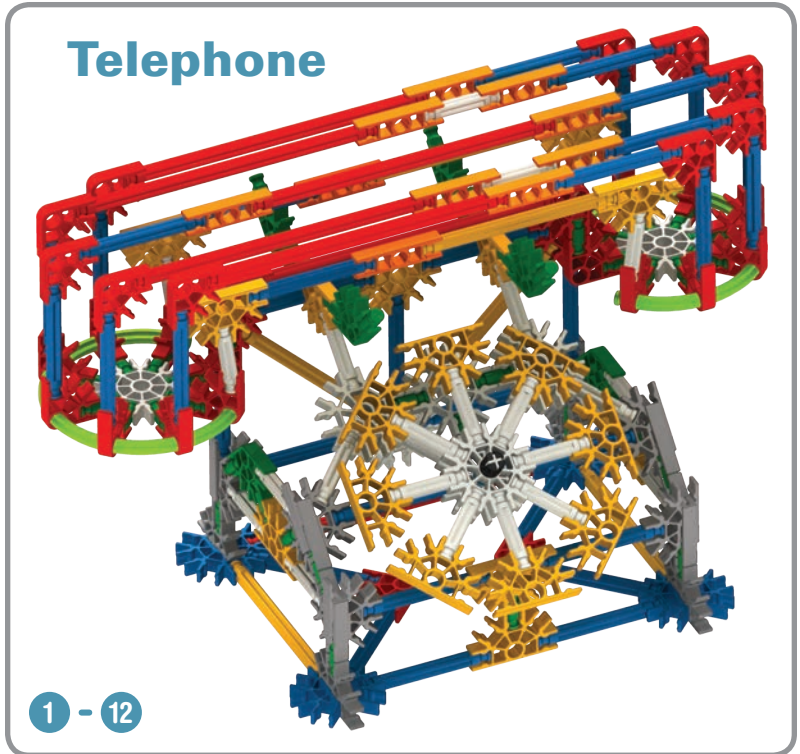
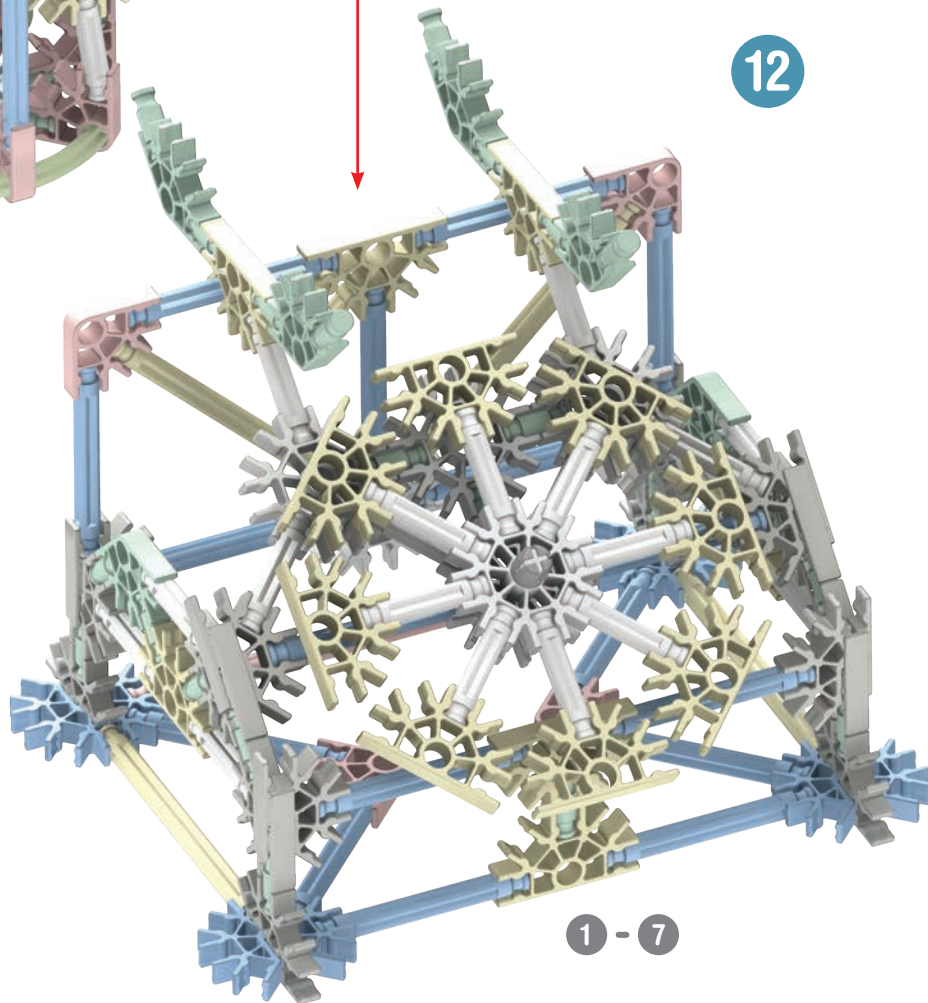

TV



x2

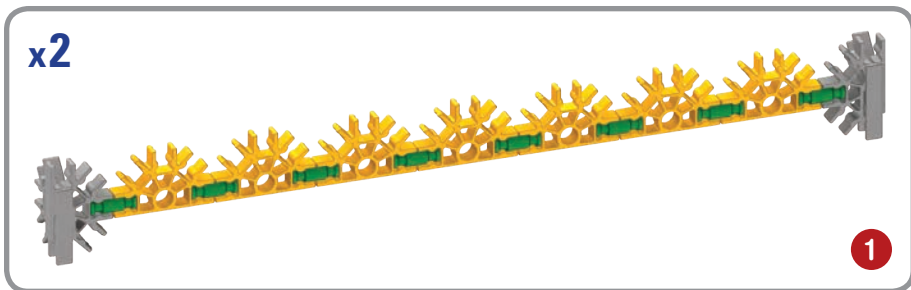

x2

1

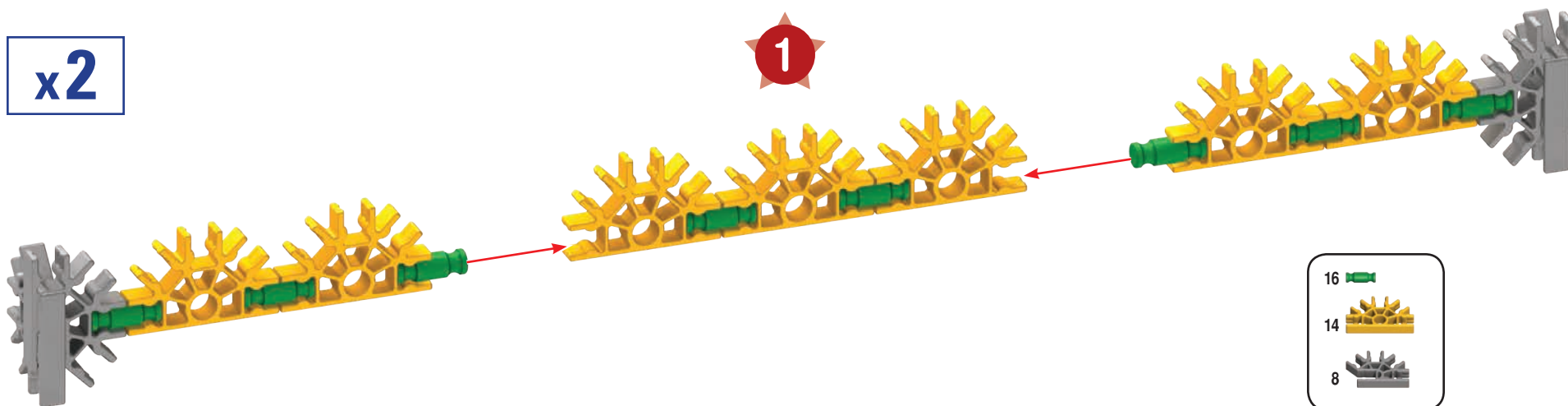

16

14

8

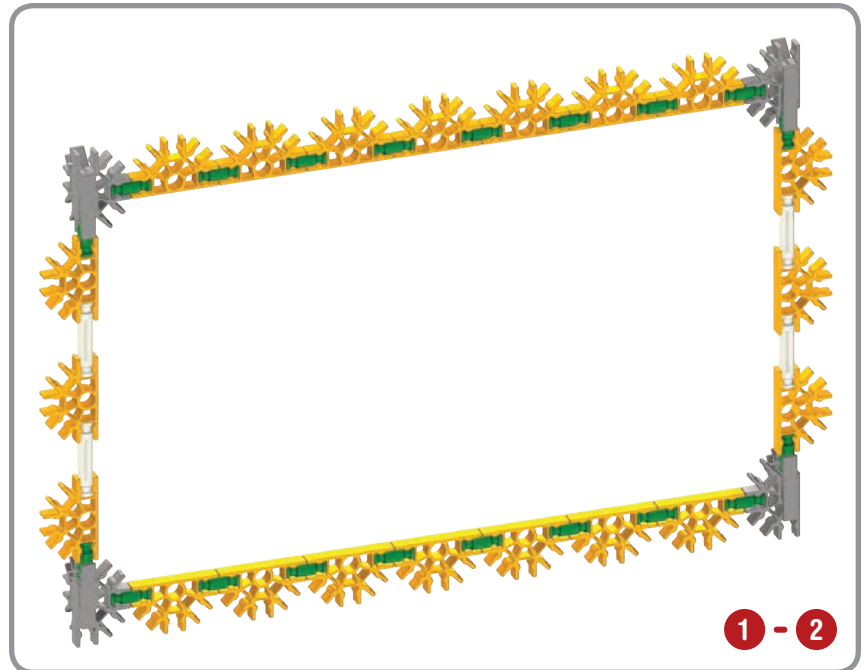
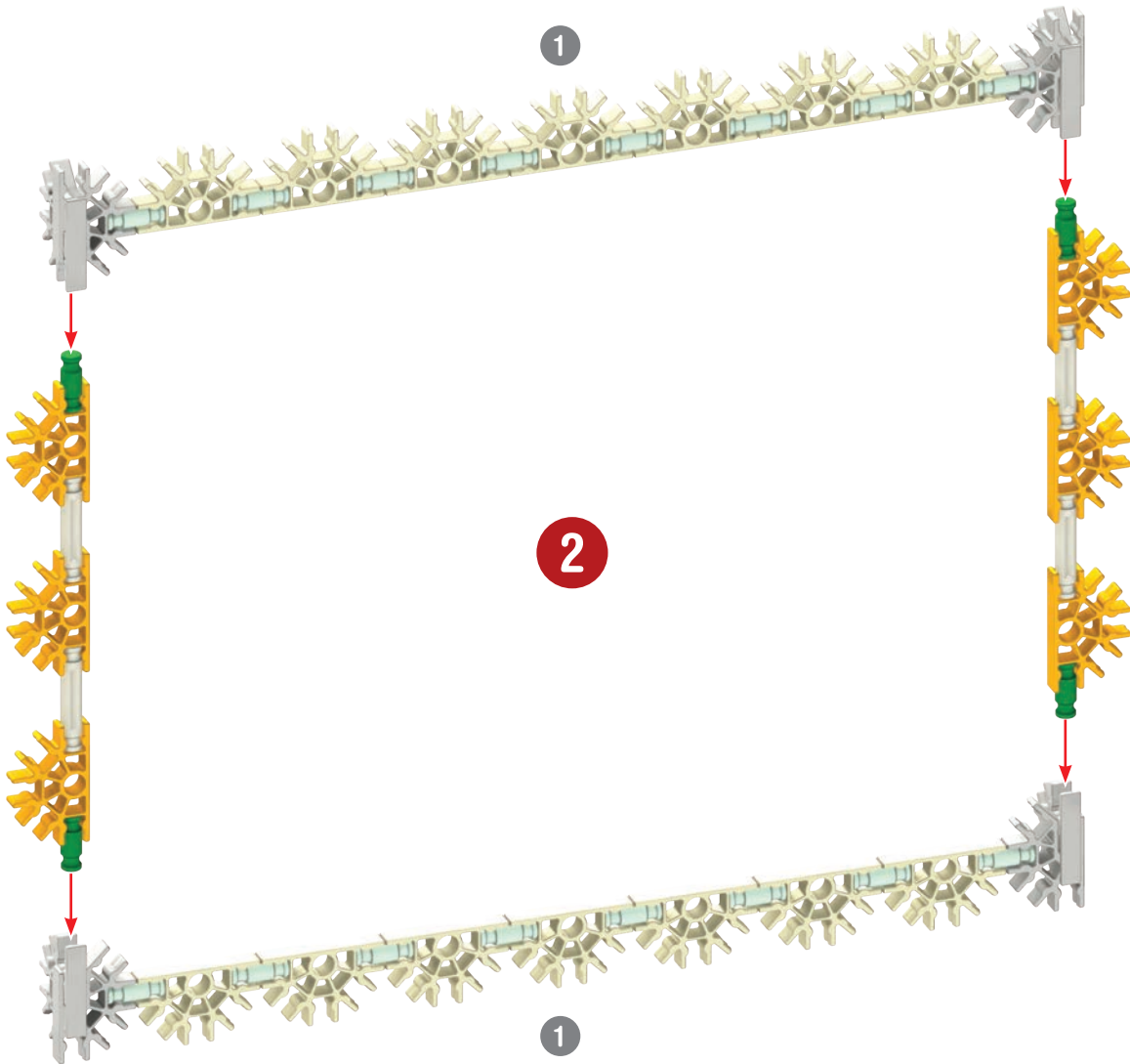

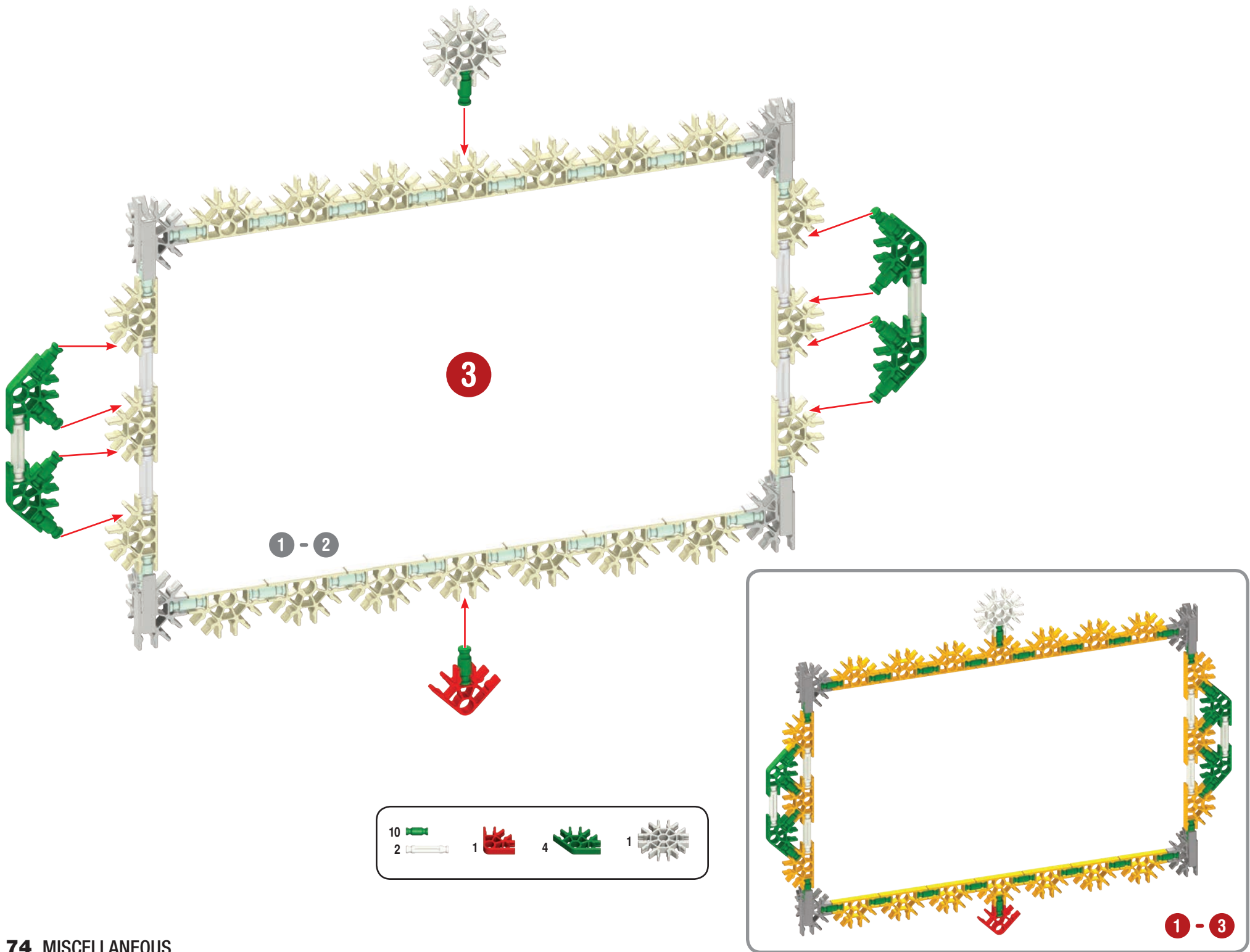

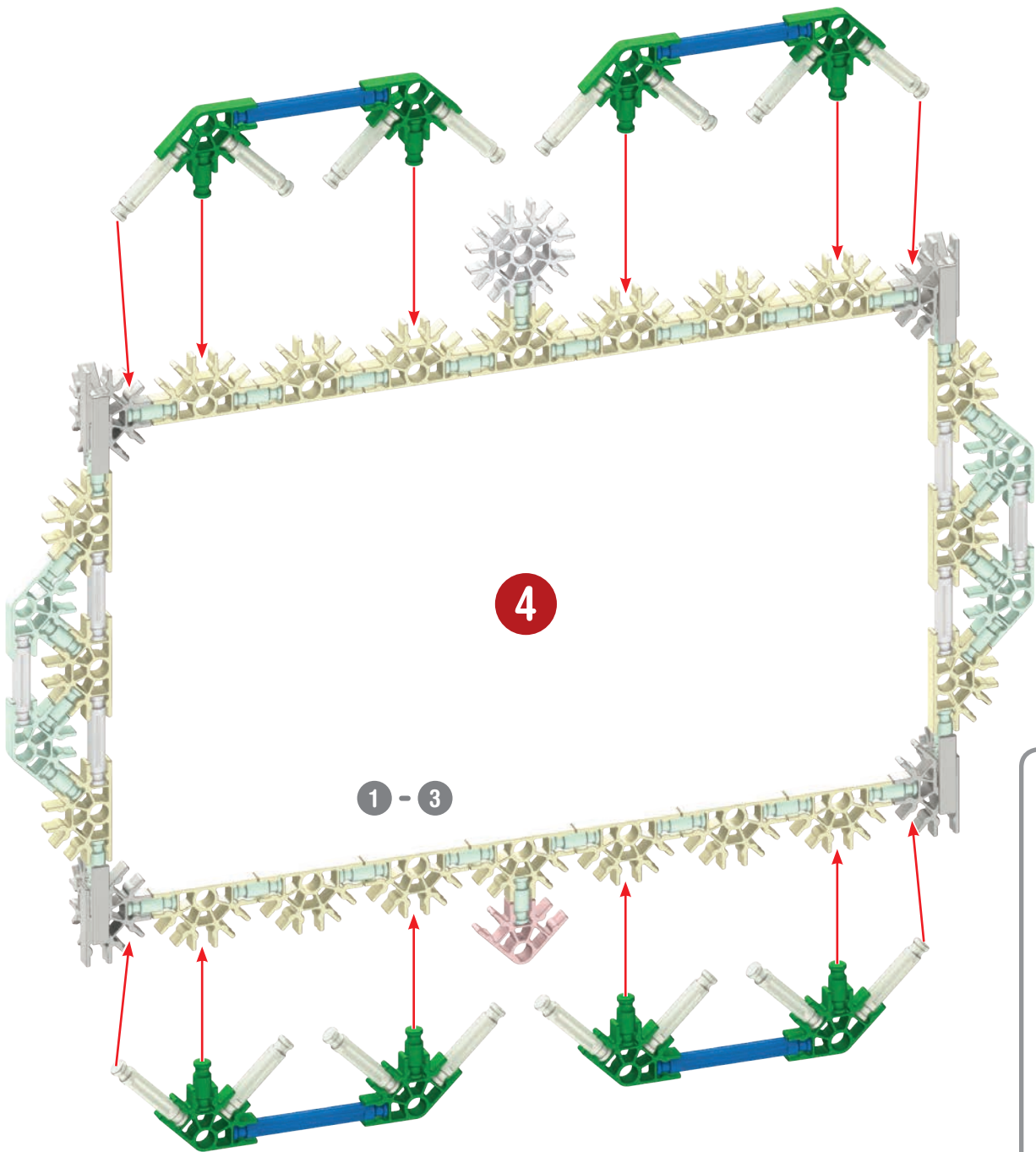

8		8	
16			
4			

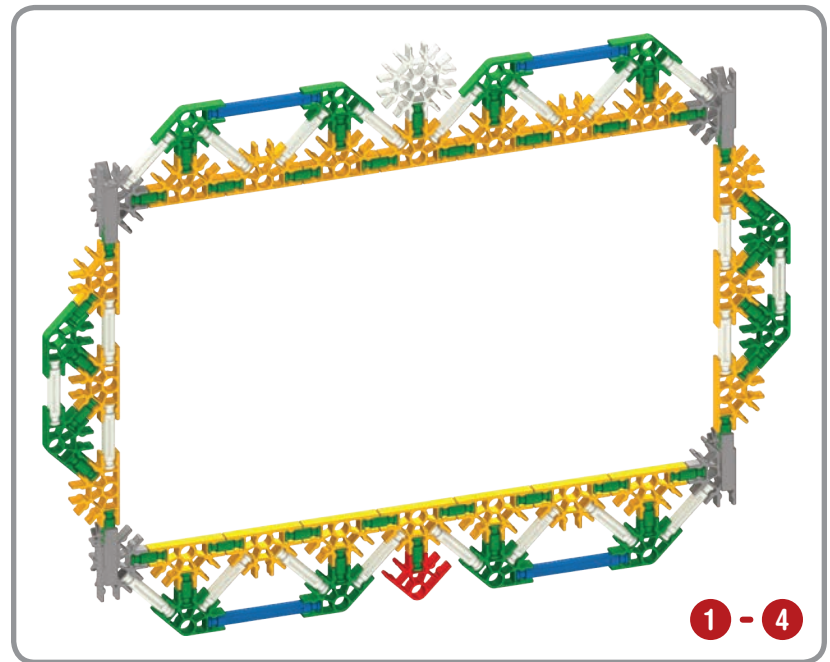

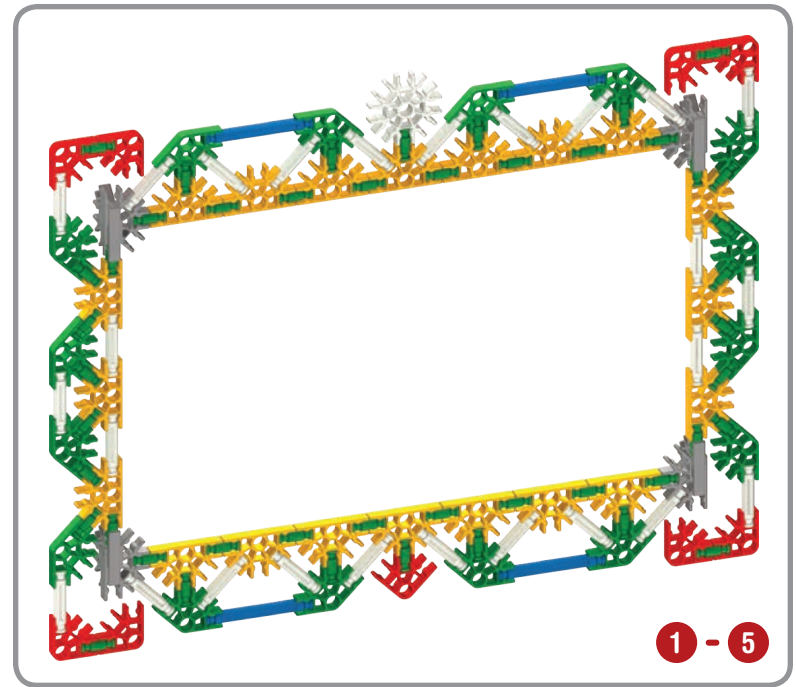
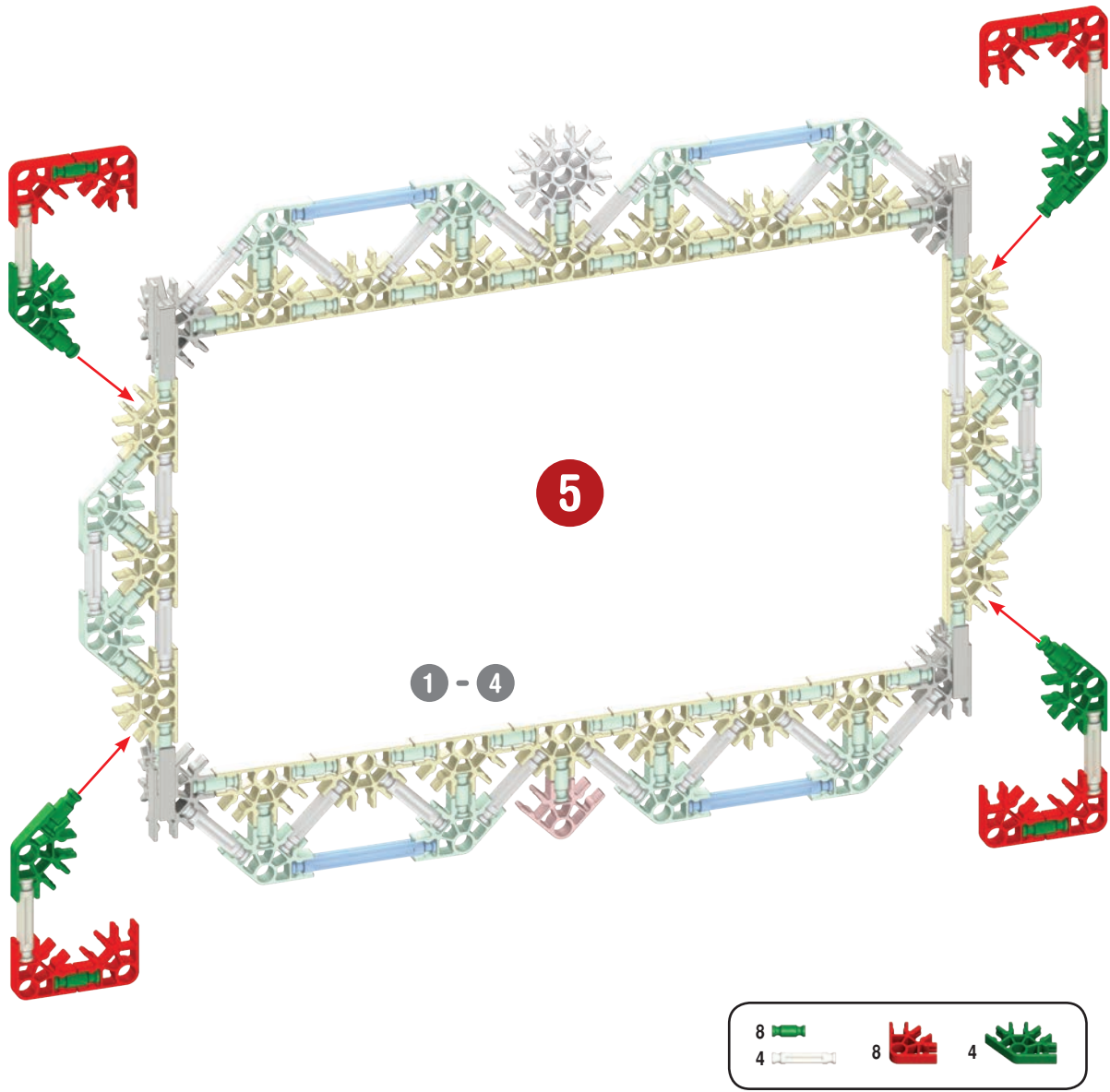

TV

