

K'Nex

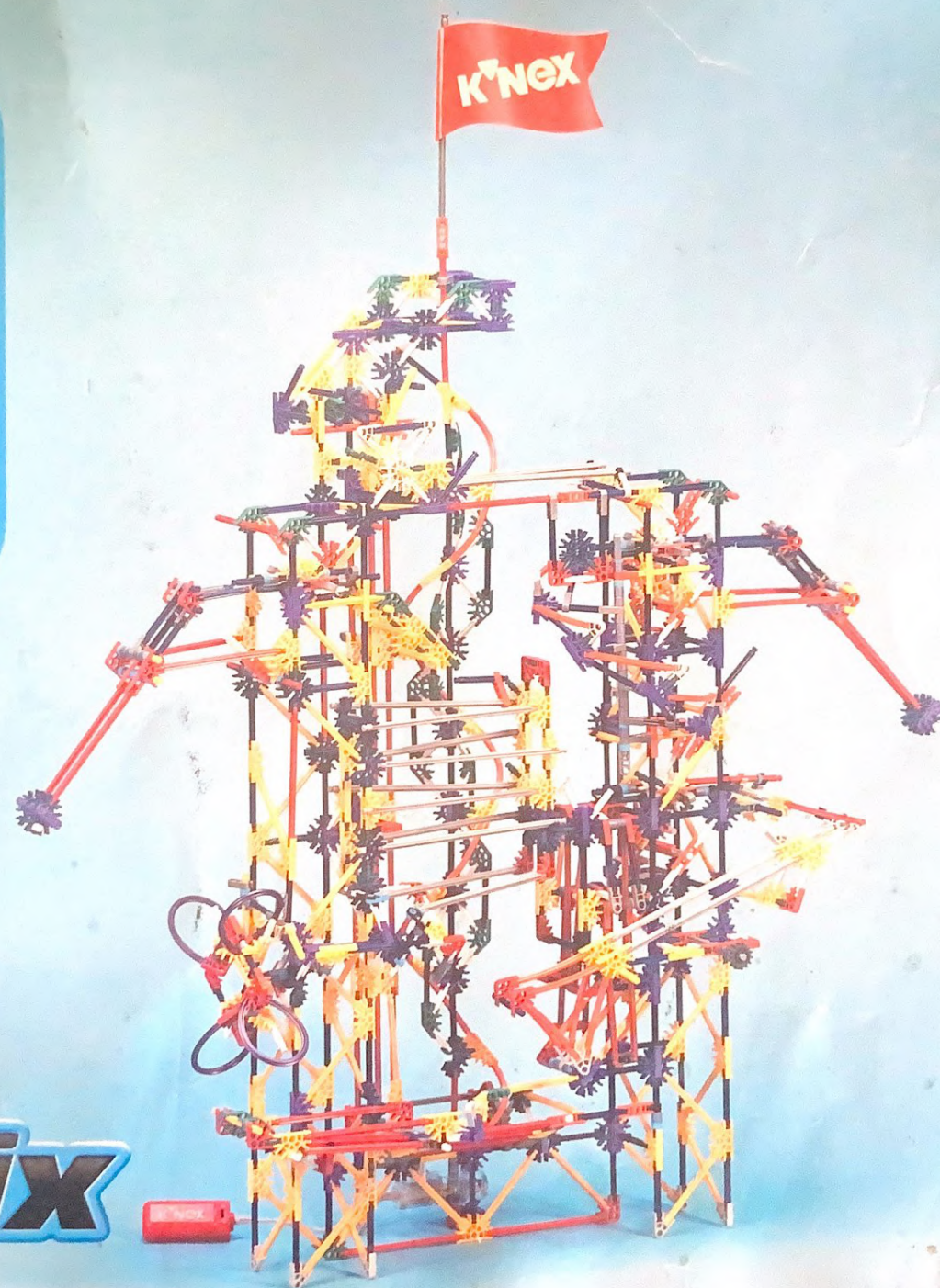

classix

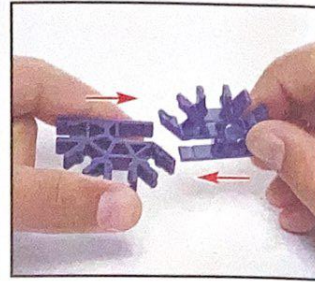
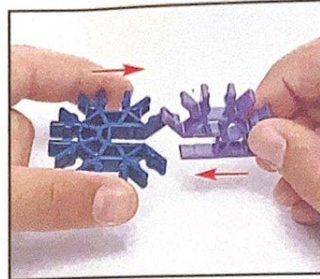
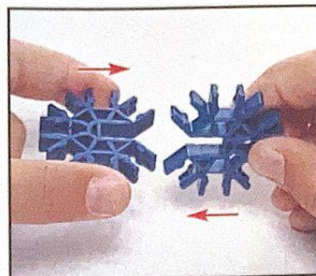
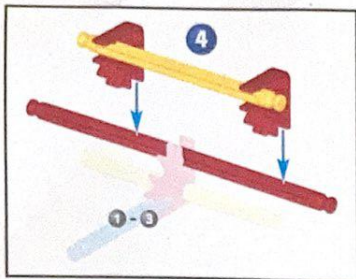
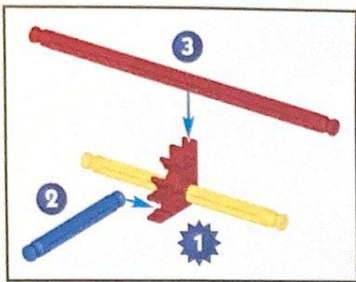

GB BUILDING TIPS: Each K'NEX piece has its own colour and shape; match it to pieces in the picture instructions. Put pieces together exactly as pictures show. Faded colours indicate sections previously built; connecting points will be in full colour.

CONSEILS D'ASSEMBLAGE: Chaque pièce K'NEX a une couleur et une forme bien à elle. Faites correspondre et montez les pièces les unes sur les autres en suivant exactement les instructions illustrées. Les couleurs plus claires indiquent les sections déjà construites. Les points de jonction sont indiqués en couleurs vives.

I CONSIGLI PER LA COSTRUZIONE: Ogni componente K'NEX è dotato di colore e forma caratteristici; basta seguire le istruzioni illustrate, mettendo i pezzi esattamente nella sequenza raffigurata. I colori schiariti indicano le sezioni costruite in precedenza; i punti di collegamento sono in colore vero.

D TIPS ZUM ZUSAMMENBAUEN: Jedes K'NEX-Teil hat seine eigene besondere Farbe und Form; vergleichen Sie jedes Teil mit denen auf den Abbildungen. Die Teile genau wie auf den Abbildungen dargestellt zusammenbauen. Die farblich heller gekennzeichneten Teile zeigen bereits zusammengebaute Abschnitte an. Die Anbringungspunkte sind in kräftigen Farben dargestellt.

E SUGERENCIAS: Cada una de las piezas K'NEX tiene su propio color y forma especiales, los cuales se deben hacer coincidir con las piezas de los dibujos de las instrucciones. Colocar las piezas exactamente como se muestra en los dibujos. Los colores apagados indican secciones que ya han sido montadas anteriormente. Los puntos de conexión se indican con colores vivos.

S BYGGTIPS: Varje K'NEX-del har en speciell färg och form. Matcha med delarna i bildanvisningarna. Sätt ihop delarna precis som visas på bilderna. Blekare färger representerar redan byggda sektioner. Anslutningspunkter visas i helfärg.

DK BYGGETIPS: Alle K'NEX dele har forskellig farve og form; find hver enkelt del på illustrationen, og sæt delene sammen, nøjagtigt som illustrationen viser. Svagere farver viser dele, som er sat sammen på forhånd; samlepunkterne vises i fuld farve.

N BYGGETIPS: Hver K'NEX-del har en særegen form og farge. Finn de samsvarende delene i bildeinstruksjonene. Sett delene sammen akkurat slik bildene viser. Svakere farger angir deler som allerede er bygget. Koblingspunktene vises med full farge.

SF RAKENNUSVINKKEJÄ: Jokainen K'NEX-pala on erivärinen jamautoinen. Kiinnitä palat ohjeissa kuvattuihin osiin. Yhdistä palat toisiinsa täsmälleen kuvissa näytetyllä tavalla. Haaleat värit kuvaavat mallin aikaisemmin koottuja osia ja liitântäkohdat on esitetty kirkailla väreillä alli toimisi.

NL BOUWTIPS: Elk K'NEX-stuk heeft zijn eigen speciale kleur en vorm; vergelijk ze met de stukken in de illustraties. Zet de onderdelen precies zo in elkaar als in de illustratie wordt aangegeven. Verbleekte kleuren geven de eerder gebouwde gedeeltes aan; de aansluitpunten worden in felle kleuren weergegeven.

P SUGESTÕES PARA CONSTRUÇÃO: Cada peça K'NEX tem a sua própria cor e forma especiais. Encaixe estas peças de forma idêntica à mostrada nas instruções ilustradas, exactamente conforme ilustrado. As cores esbatidas indicam secções previamente construídas. Os pontos de ligação são apresentados em cores sólidas.

G ΣΥΜΒΟΥΛΕΣ ΚΑΤΑΣΚΕΥΗΣ: Κάθε κομμάτι K'NEX έχει το δικό του χρώμα και σχήμα. Ταίριαξτε το με τα κομμάτια που φαίνονται στις φωτογραφίες. Ενώστε τα κομμάτια όπως ακριβώς δείχνουν οι φωτογραφίες. Τα ξεθωριασμένα χρώματα υποδεικνύουν τα τμήματα που έχετε ήδη κατασκευάσει. Τα σημεία σύνδεσης φαίνονται με κανονικό χρώμα.

TR MONTAJ İÇİN TAVSİYELER: Her bir K'NEX parçasının kendine özgü özel renk ve şekli vardır; bu parçaları teker teker resimli açıklamadaki parçalara bakarak eşleştirin. Parçaları tam resimlerde görüldüğü gibi biraraya getirin. Soluk renkler daha önce monte edilmiş kısımları göstermektedir. Birleştirilecek noktalar (daha koyu olan) tam renkle gösterilmiştir.

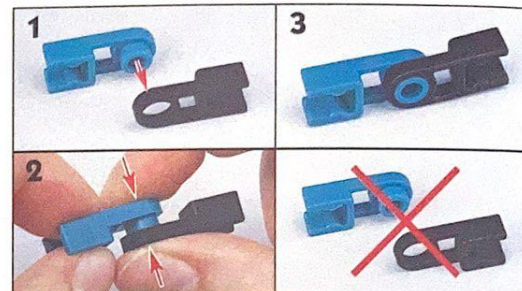

CHI 建造提示: 每一塊 K'NEX 零件有特別的顏色和形狀; 將這些零件與圖片說明的組合片對上。依圖片將零件逐一組合起來。淺色的部份表示已拼裝好; 接合點會以全色顯示。

J 組み立て上の注意 K'NEXの各部品は、それぞれカラーや形状が異なります。各部品を説明図と照らし合わせて確認してください。部品は説明図にしたがって正しく組み合わせてください。薄いカラーで表示されている部分は、すでに組み立てられた部分です。接続する部分は、実際のカラーで示されています。

K 조립 힌트: K'NEX 부품 하나 하나는 제각기 다른 색상과 모양 을 갖습니다 그림 설명서 그대로 부품들을 맞추십시오 그리고 그림에 서 보여주는 대로 정확하게 부품들을 조립하십시오. 흐린 색상은 이미 조립된 부분을 표시합니다 조립할 연결 부분은 진한 색상으로 표시되어 있습니다.

IL טיפים לבניה. לכל חלק של K'NEX צבע וצורה מיוחדים לו. התאם אותם לחלקים המופיעים בתמונות שבהוראות. חבר את החלקים בדיוק שפי שרואים בתמונות. צבעים דהויים מצביעים על חלקי דגם שכבר נבנו קודם לכן. נקודות החיבור מופיעות בצבעים מלאים.

Ball Machine

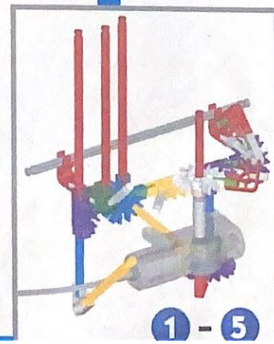
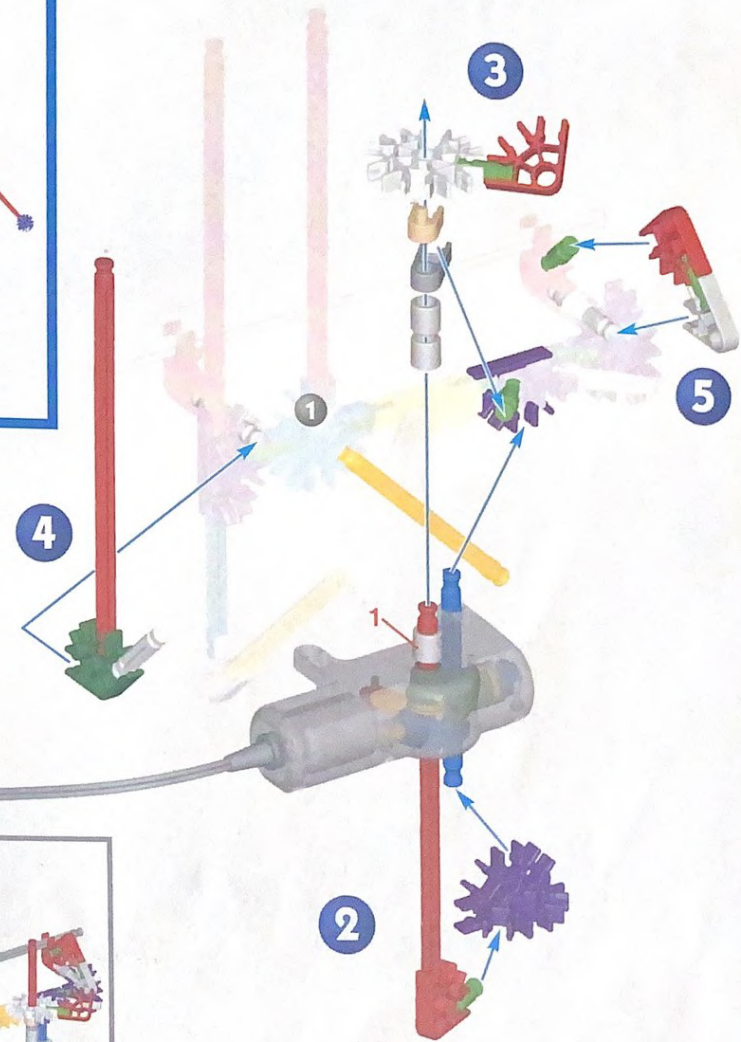
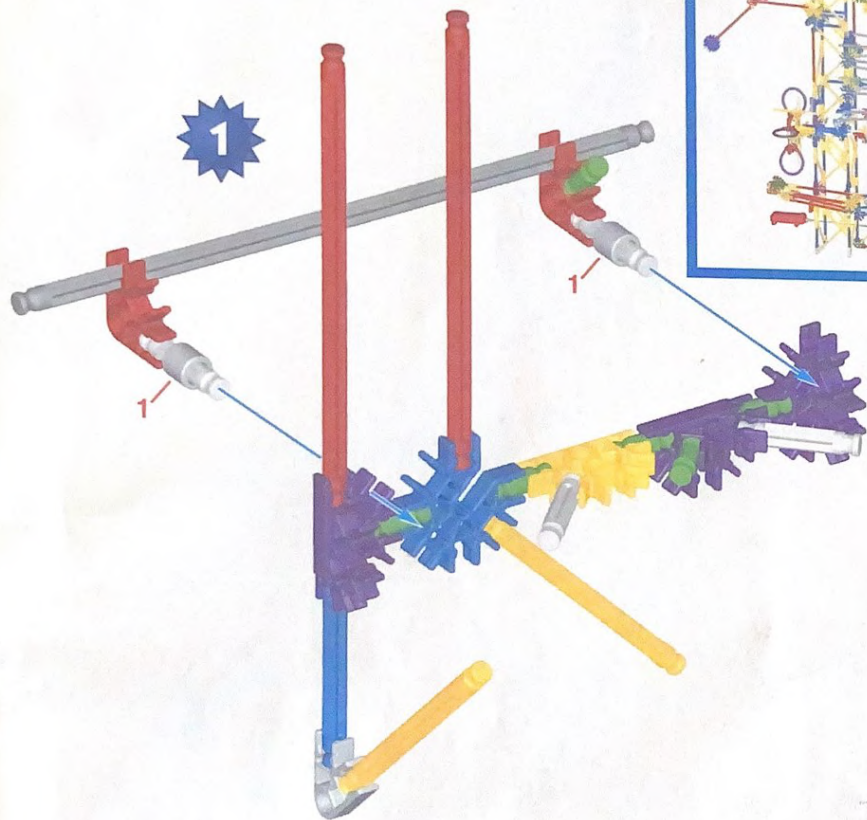
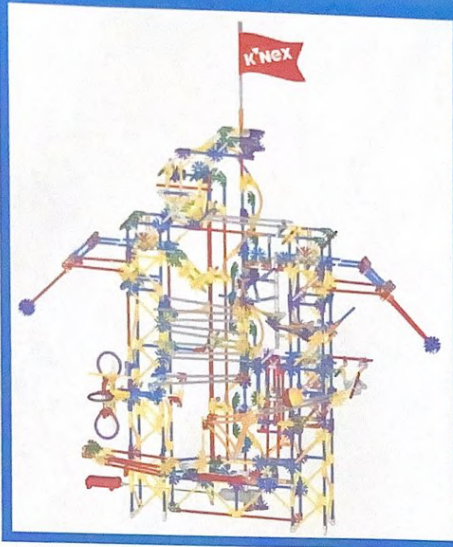

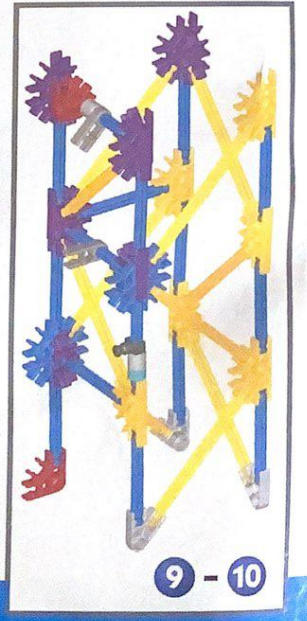
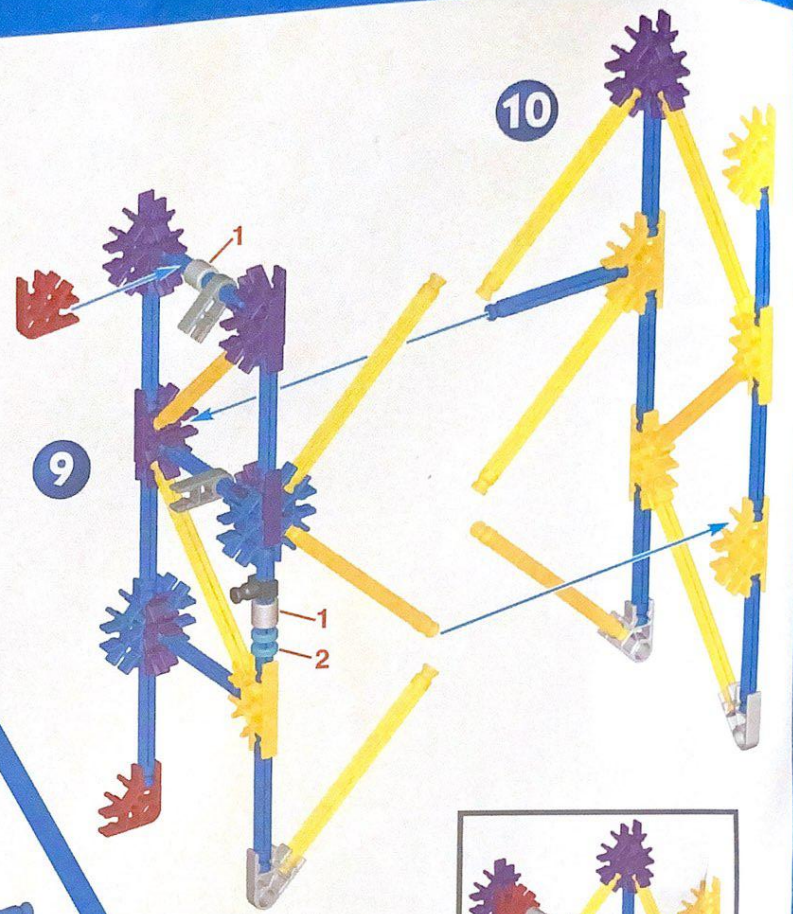
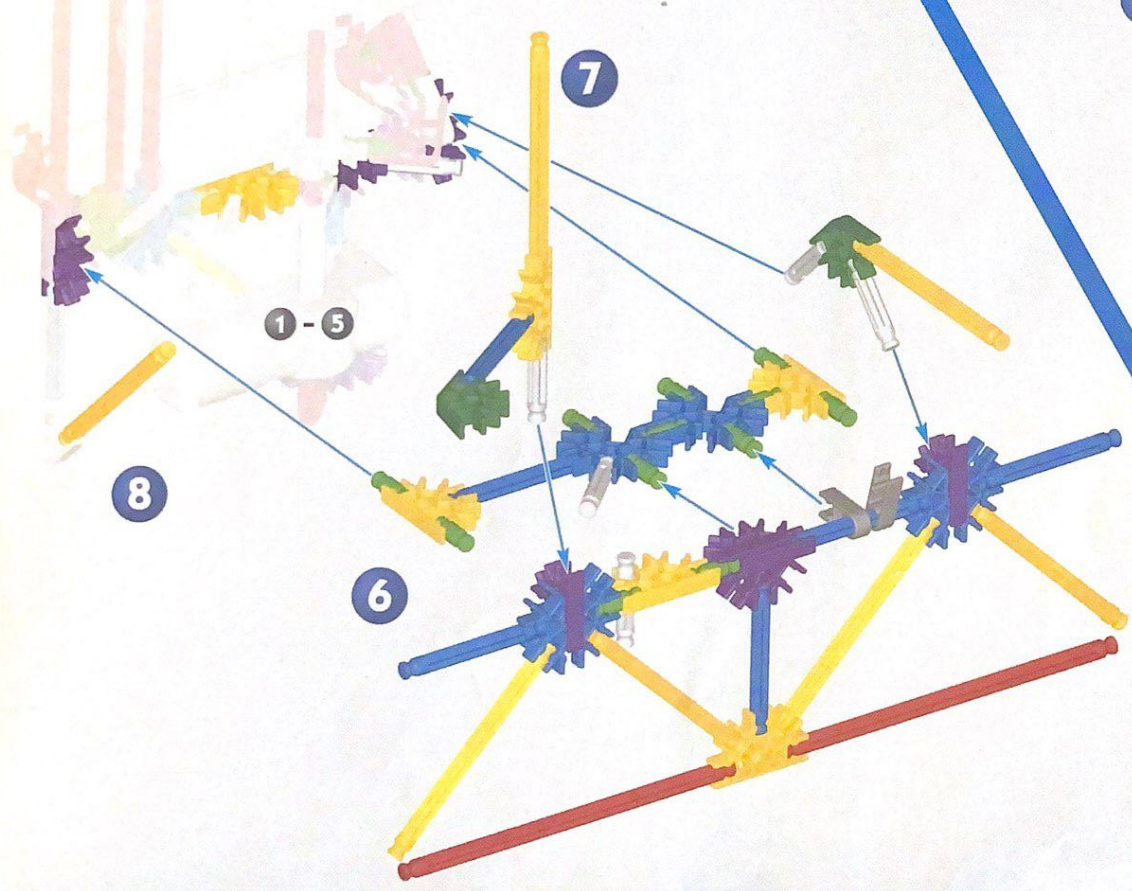
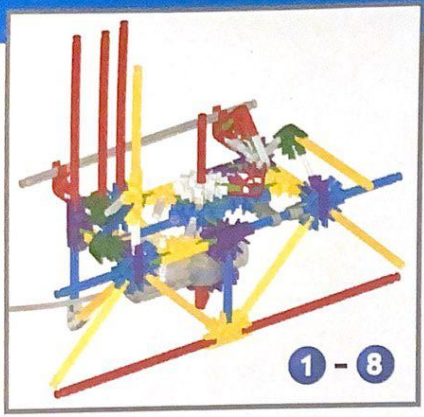

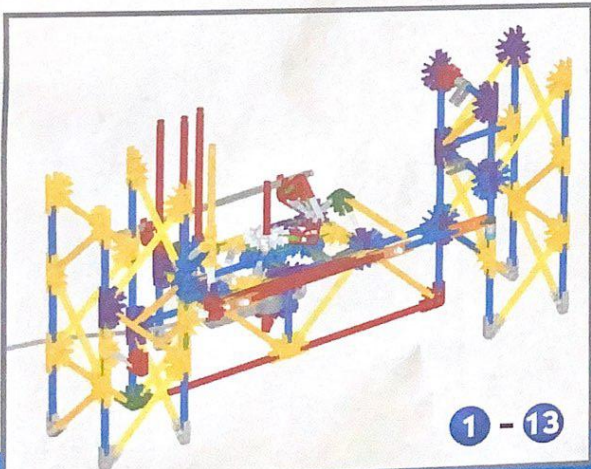
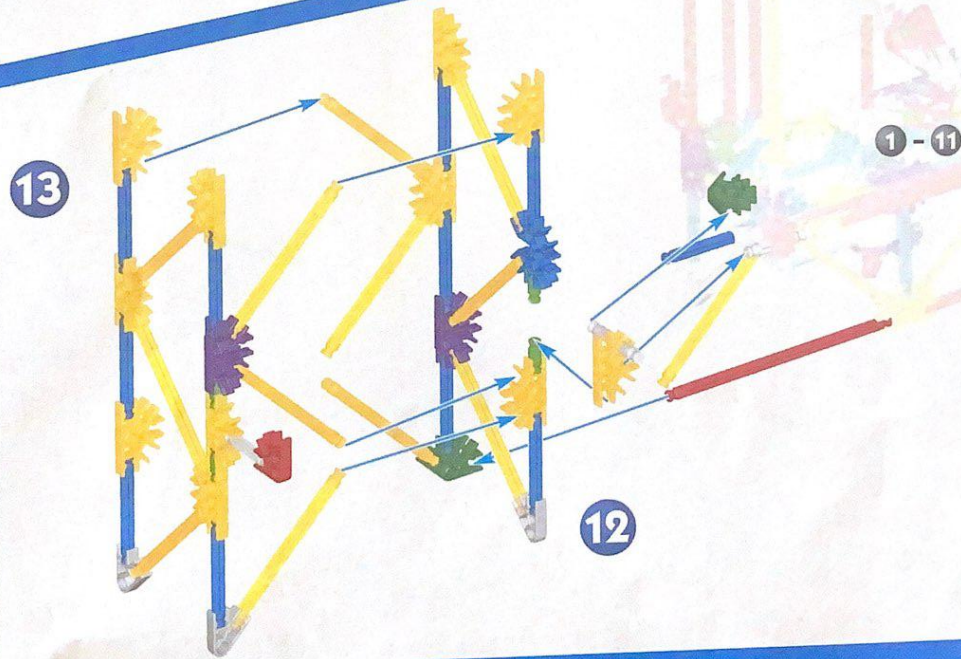
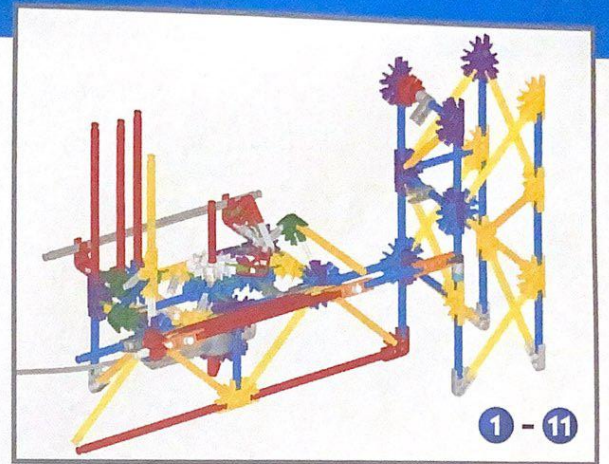
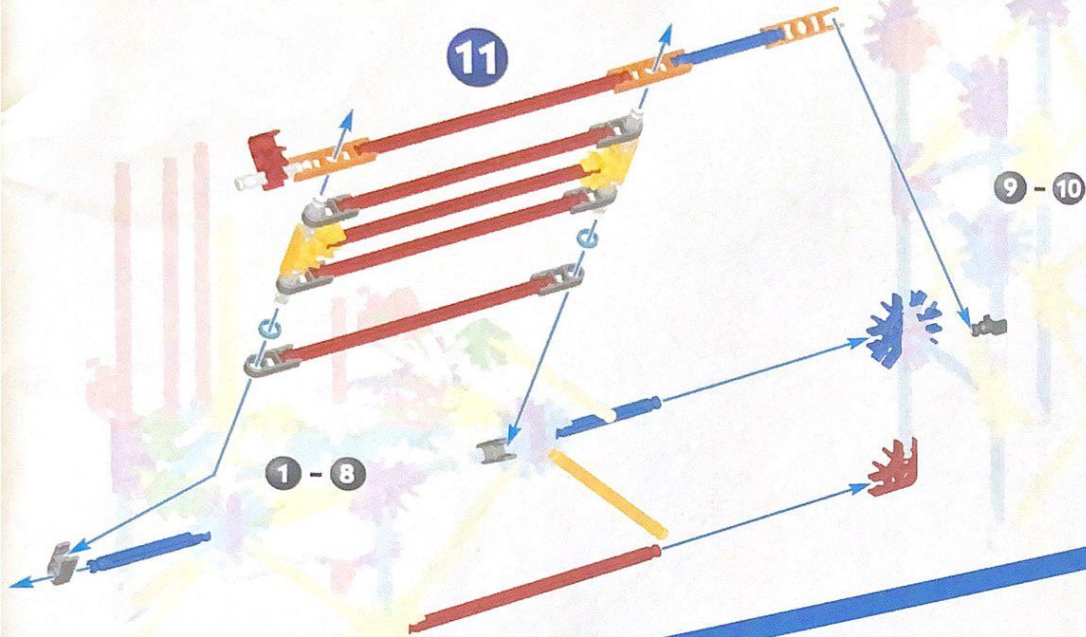

14

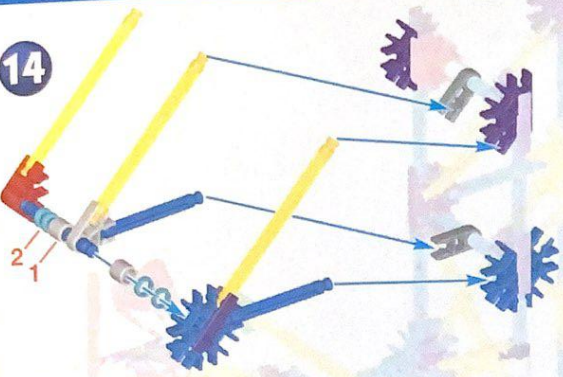

1 - 13



1 - 14

1 - 14

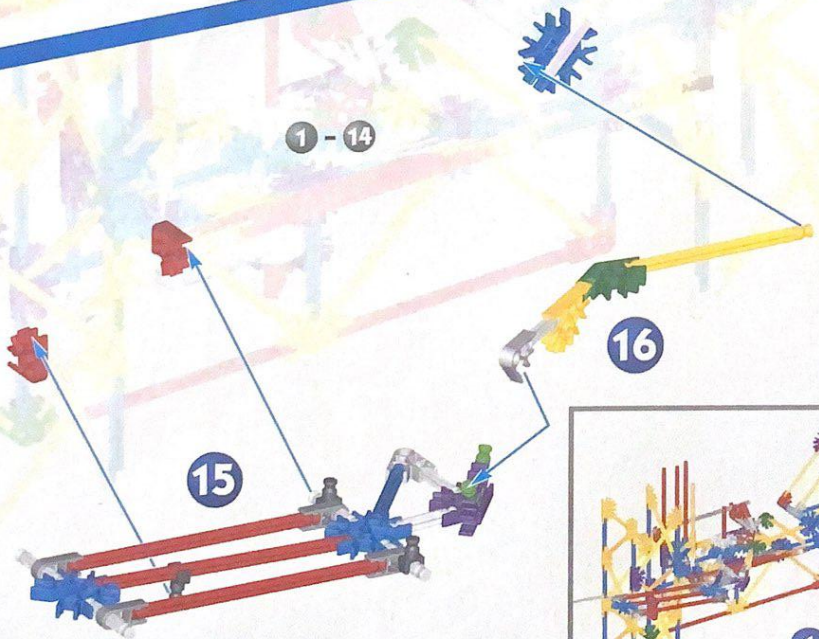

15

16

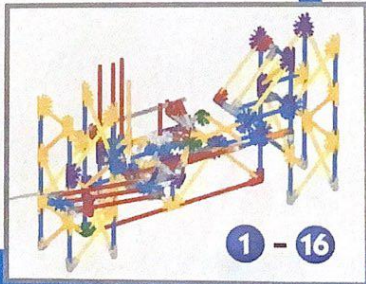

1 - 16

17

18

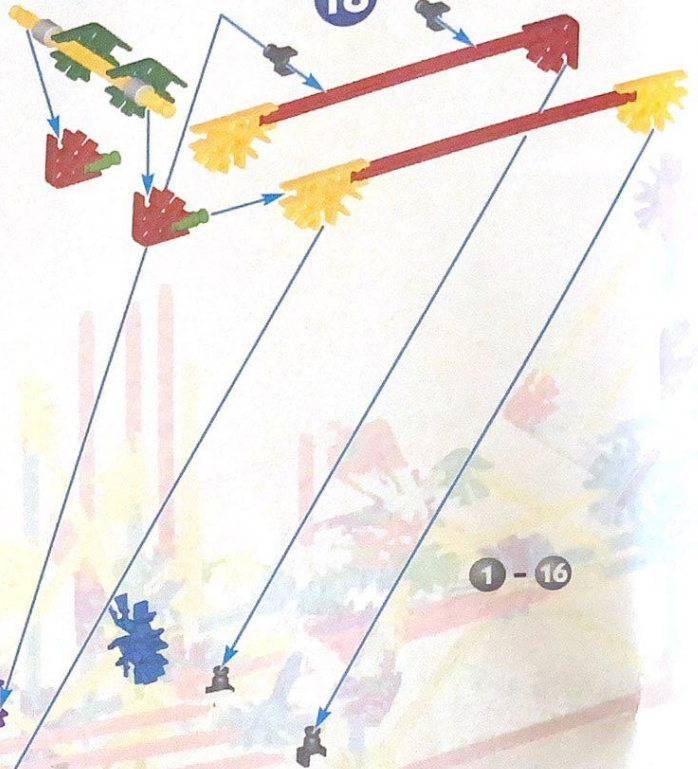

1 - 16

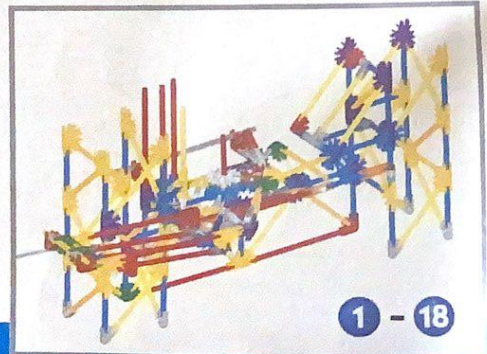

1 - 18

20

19

1 - 18

1 - 20

21

1 - 20

1 - 21

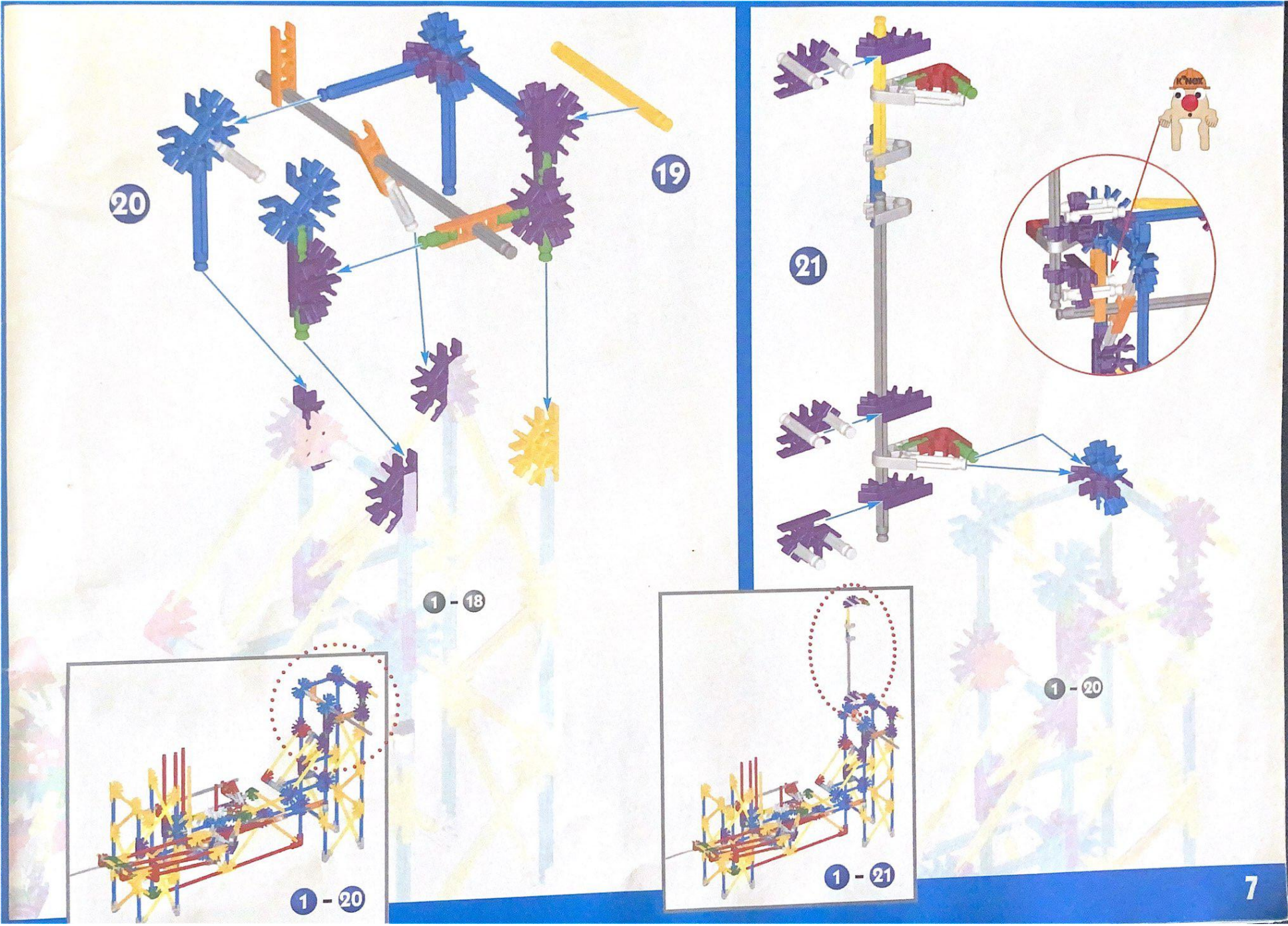
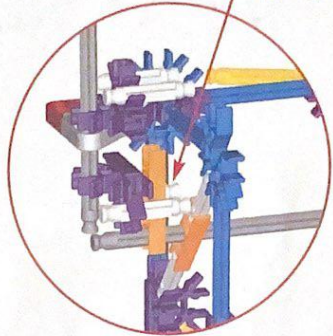
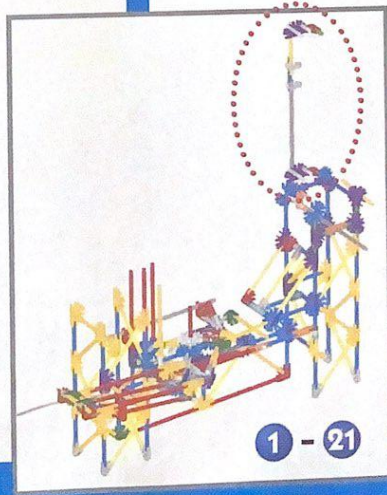
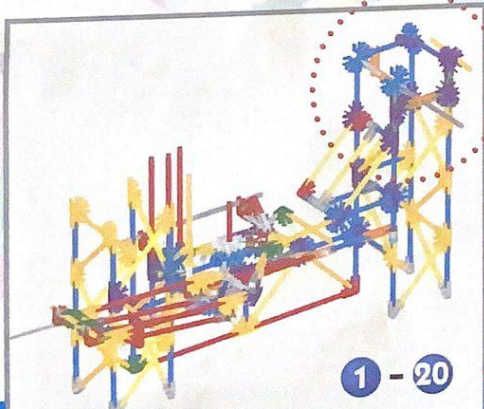

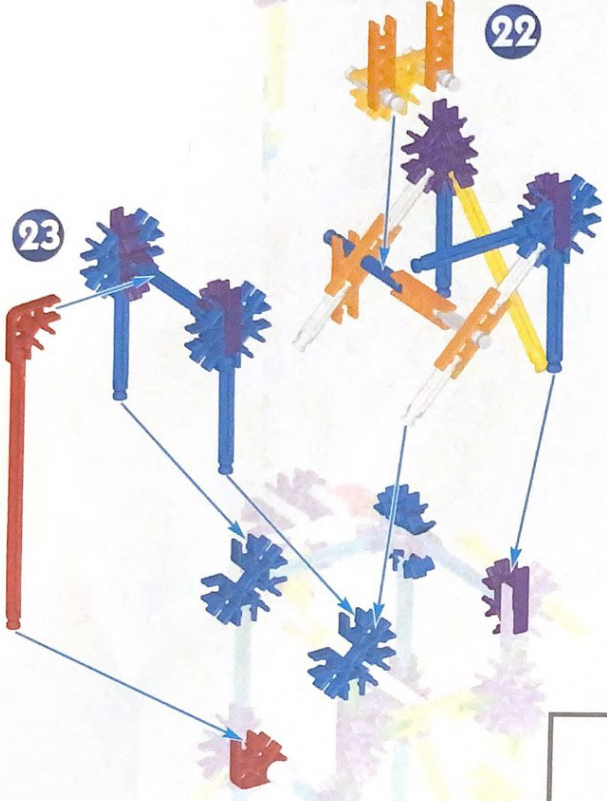

1 - 21

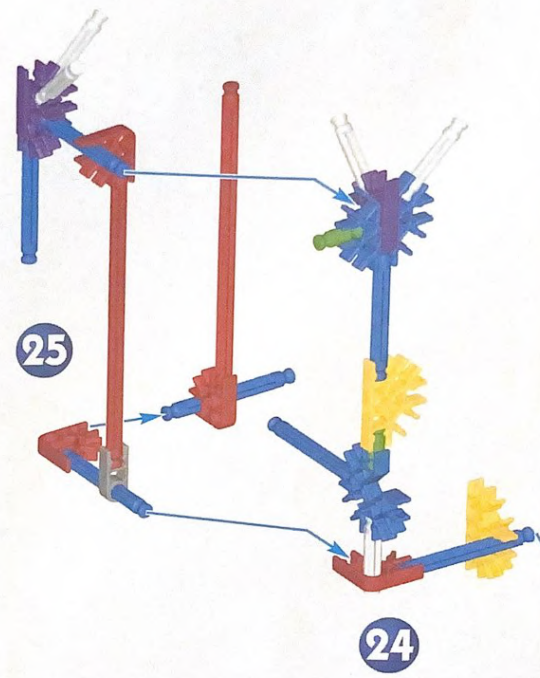

1 - 23

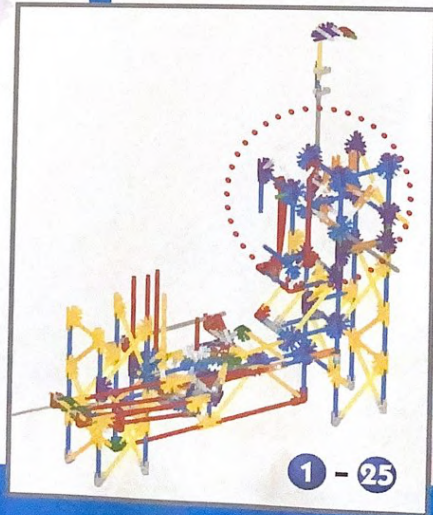

1 - 25

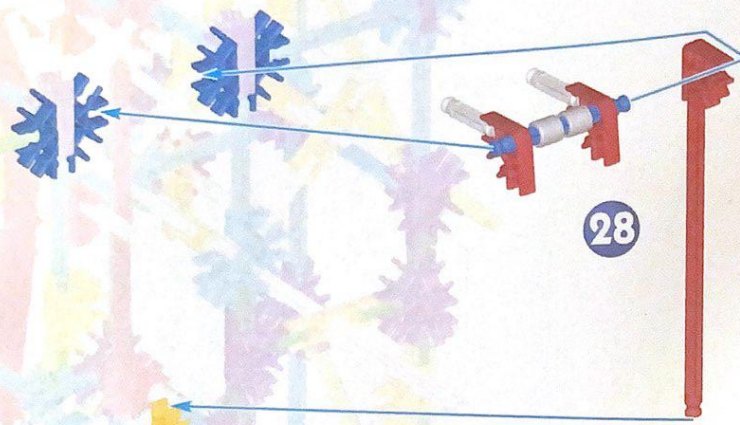

1 - 27

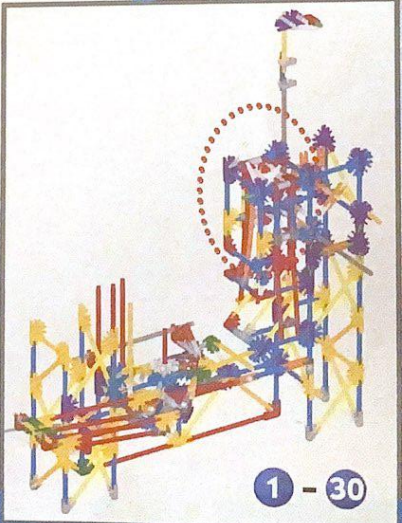

1 - 28

2 2

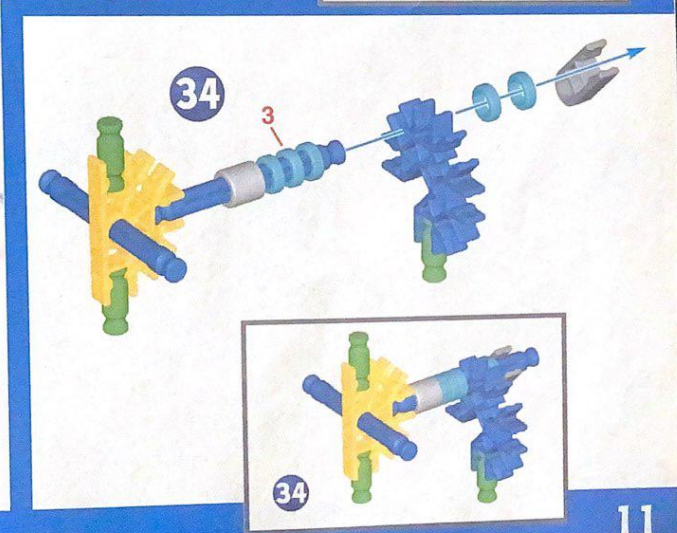
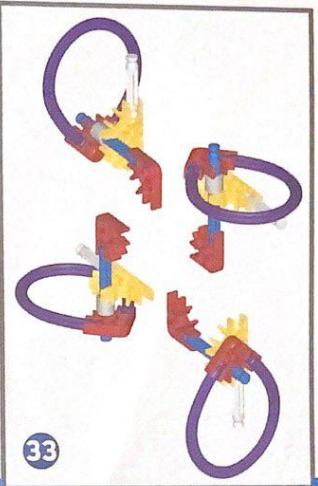
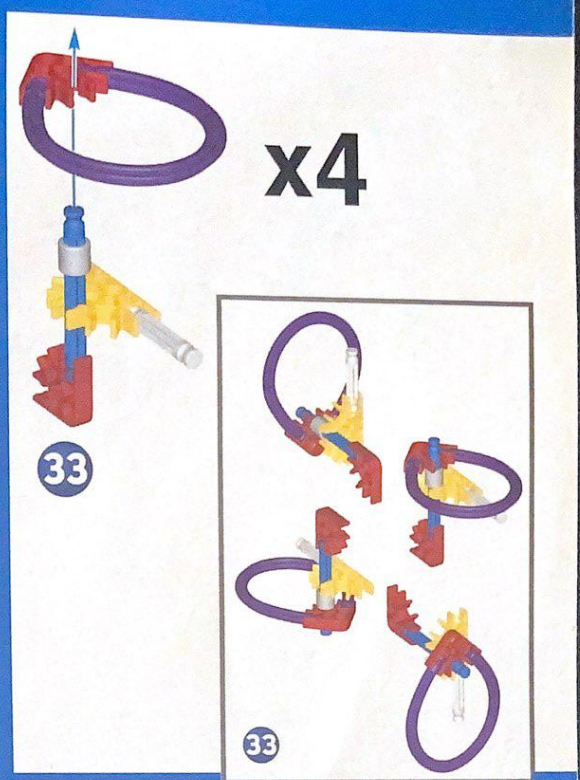
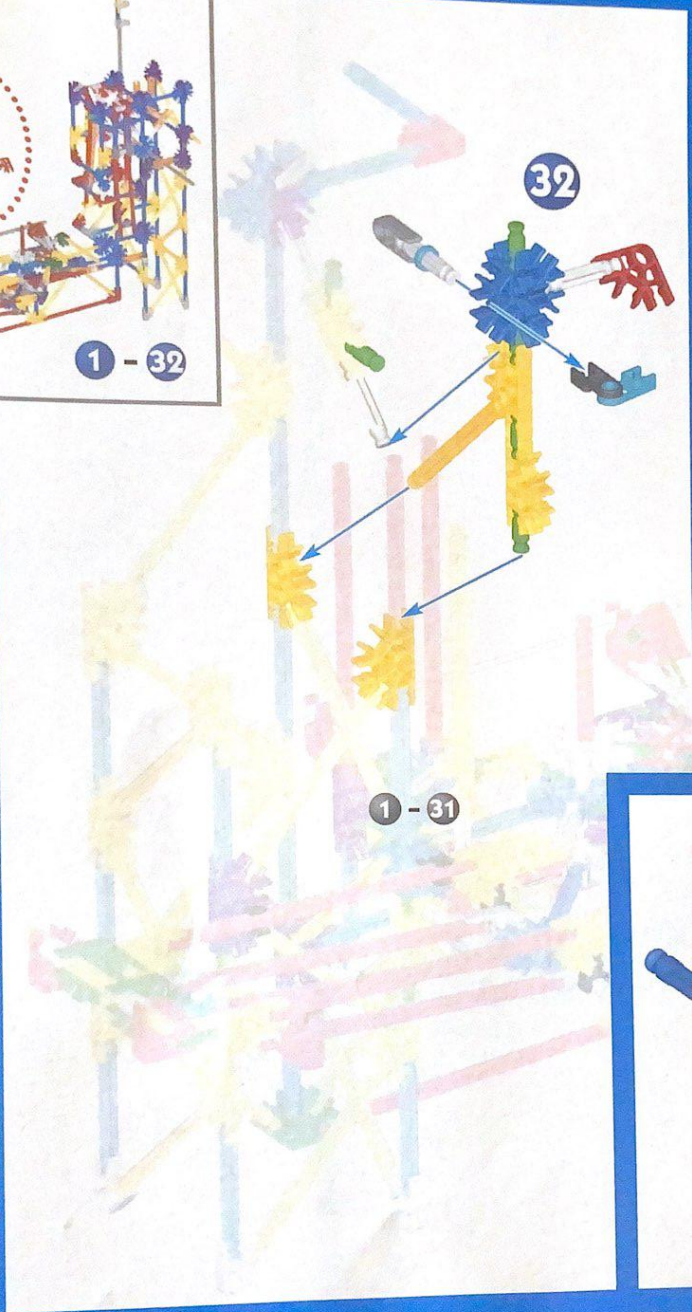
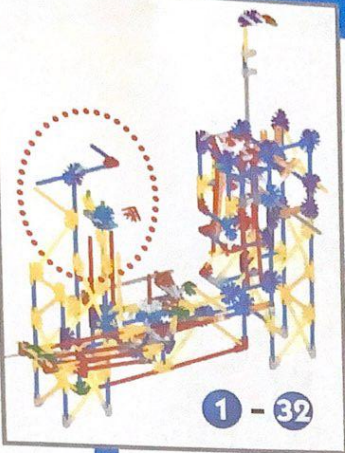
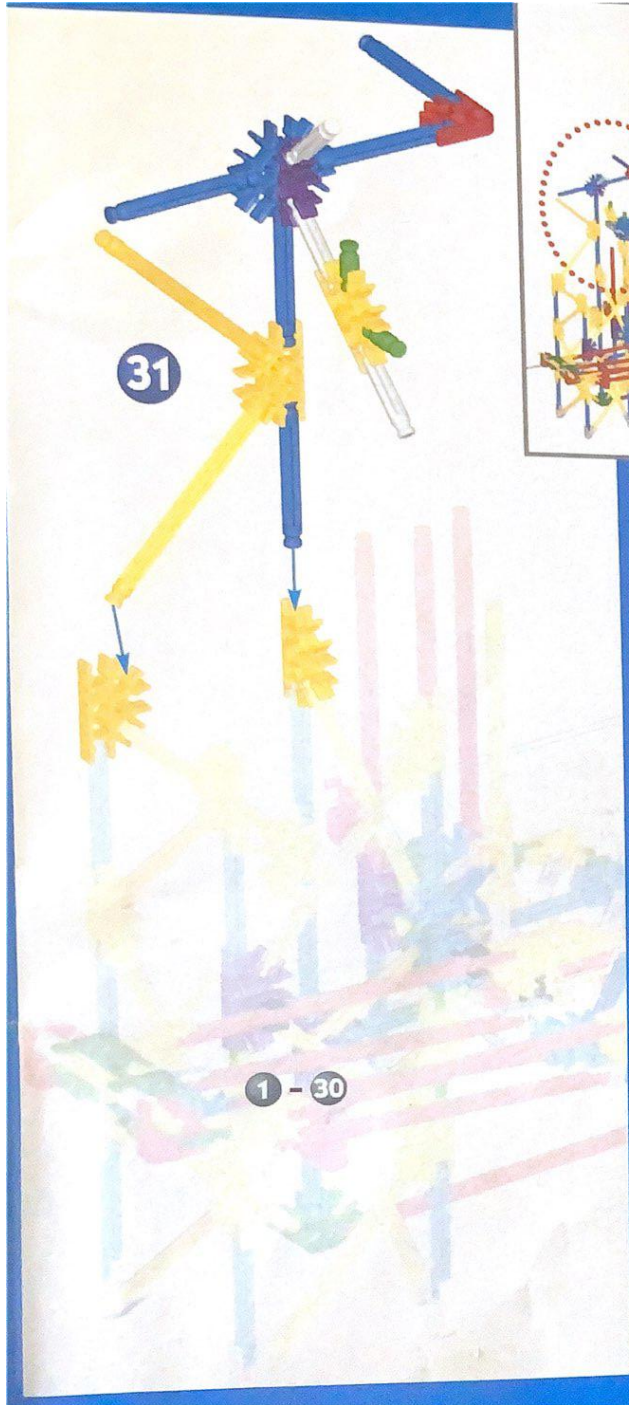

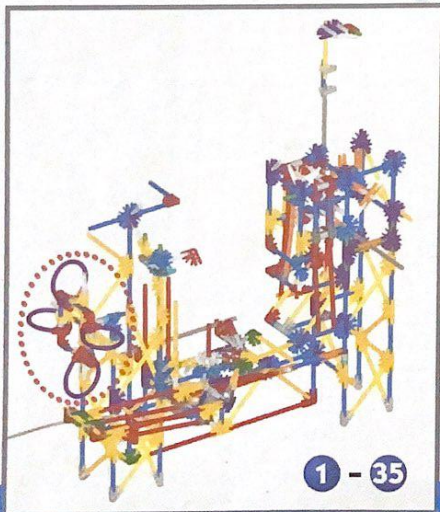
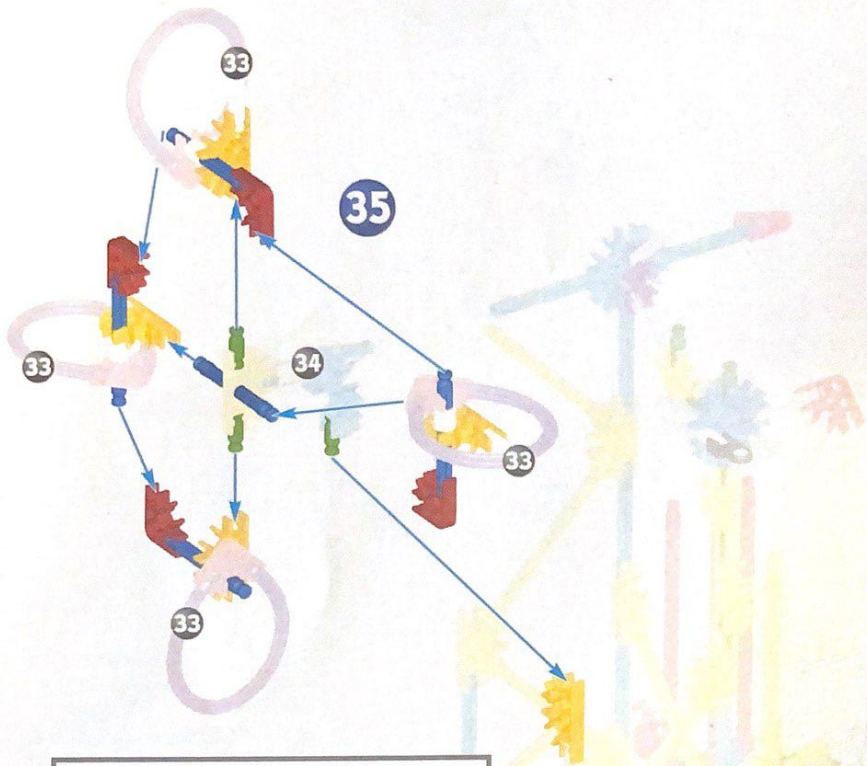

1 - 32

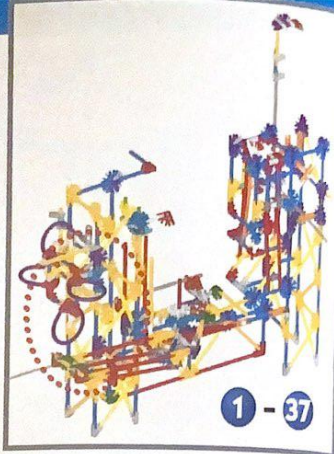
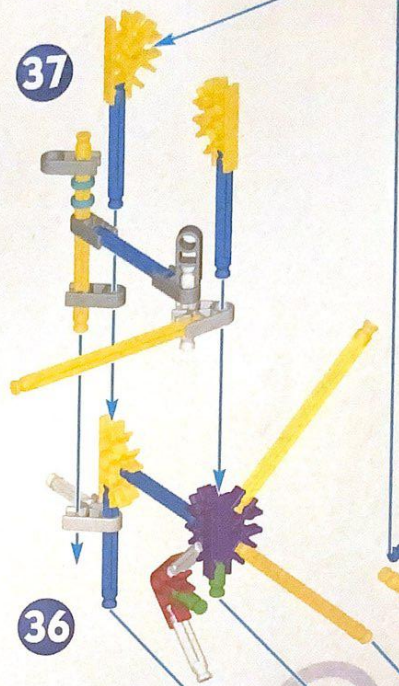

1 - 35

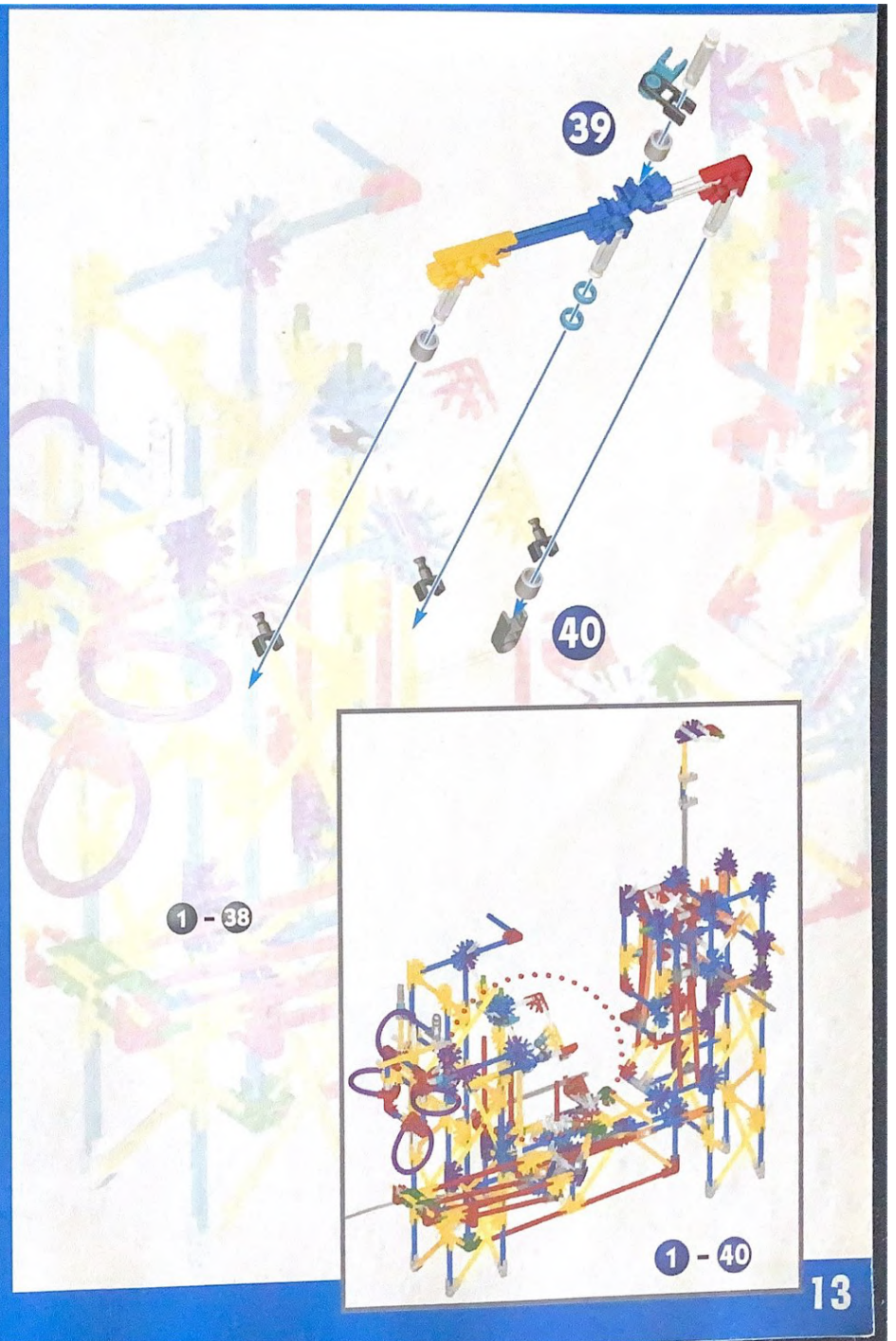
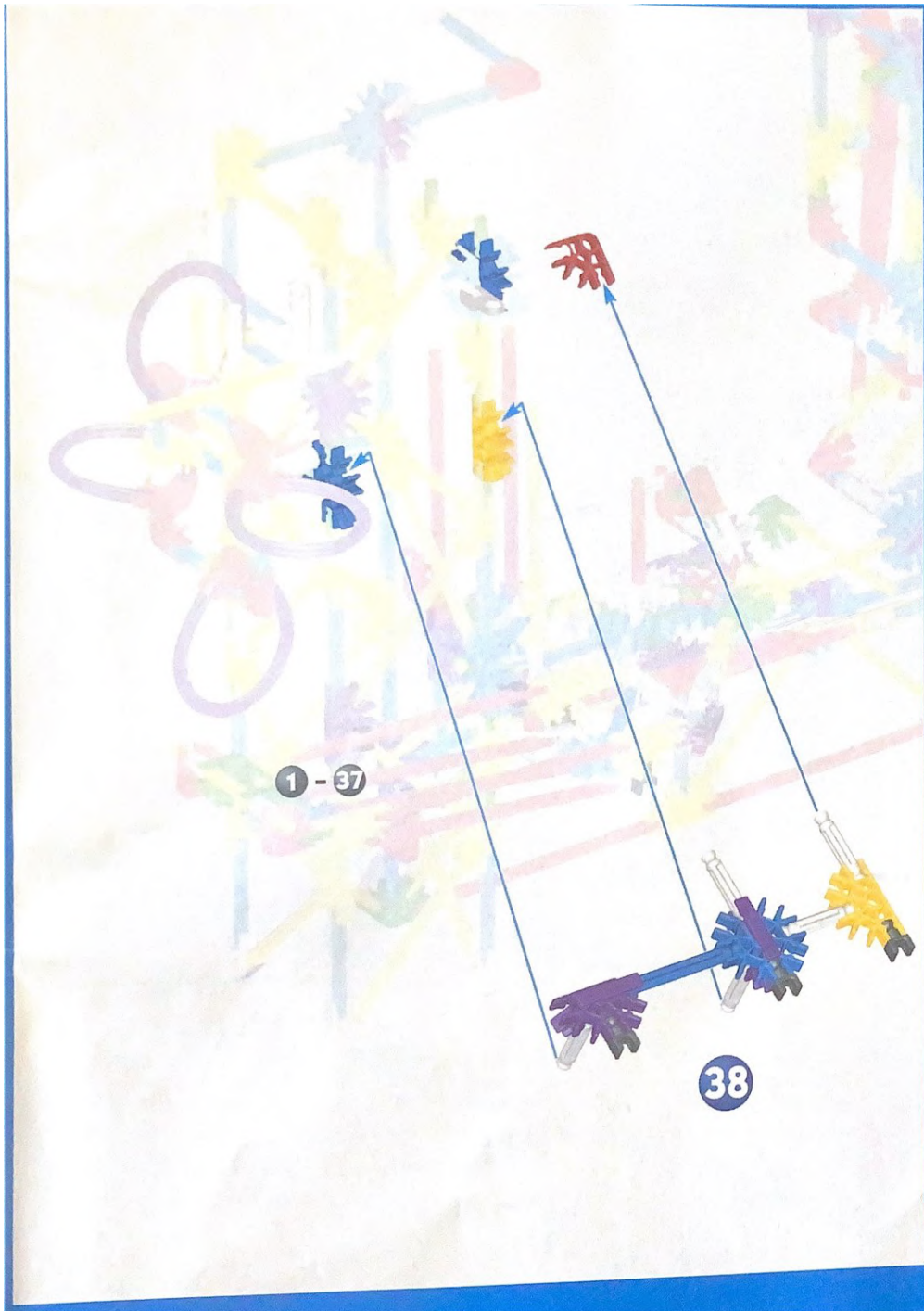

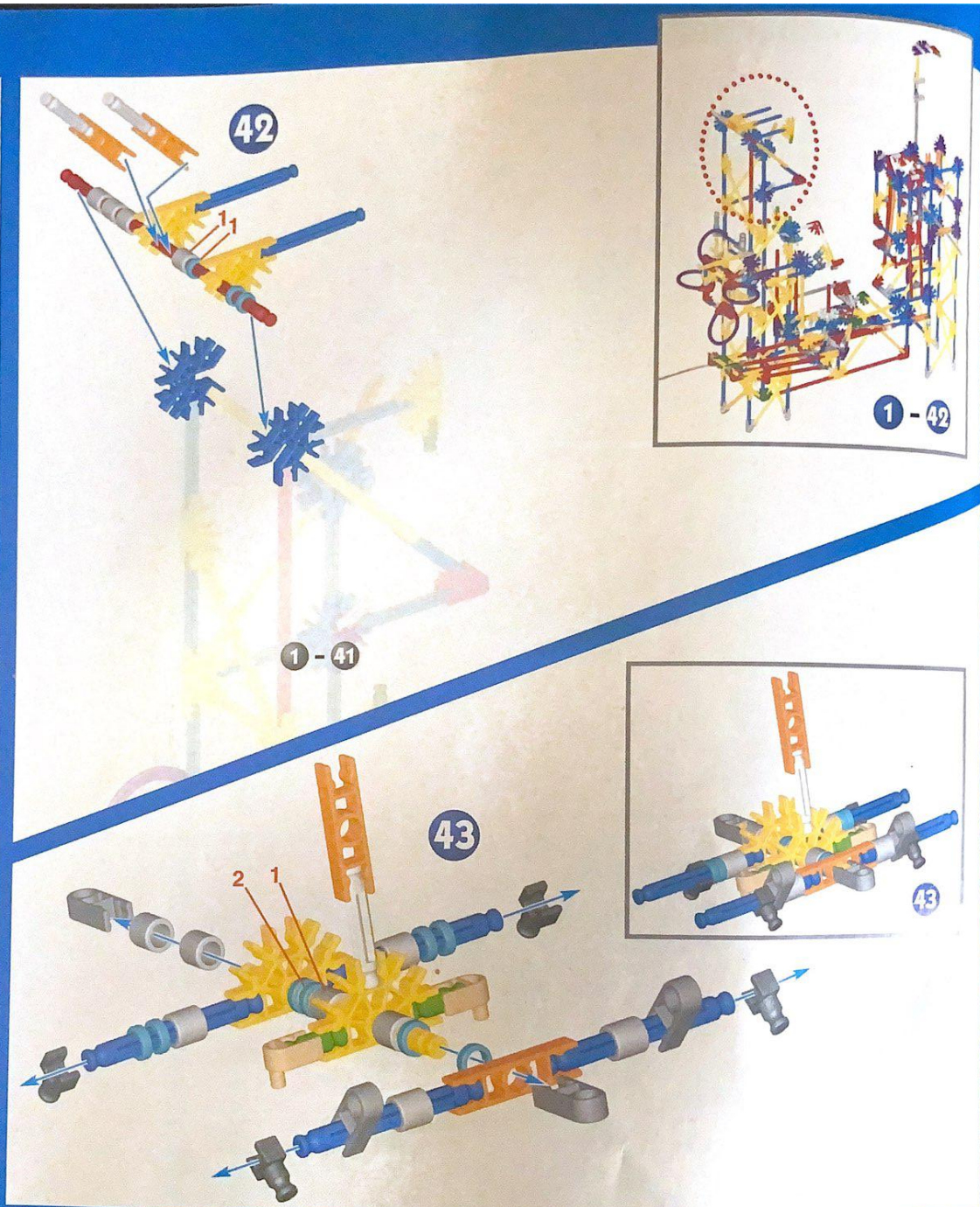

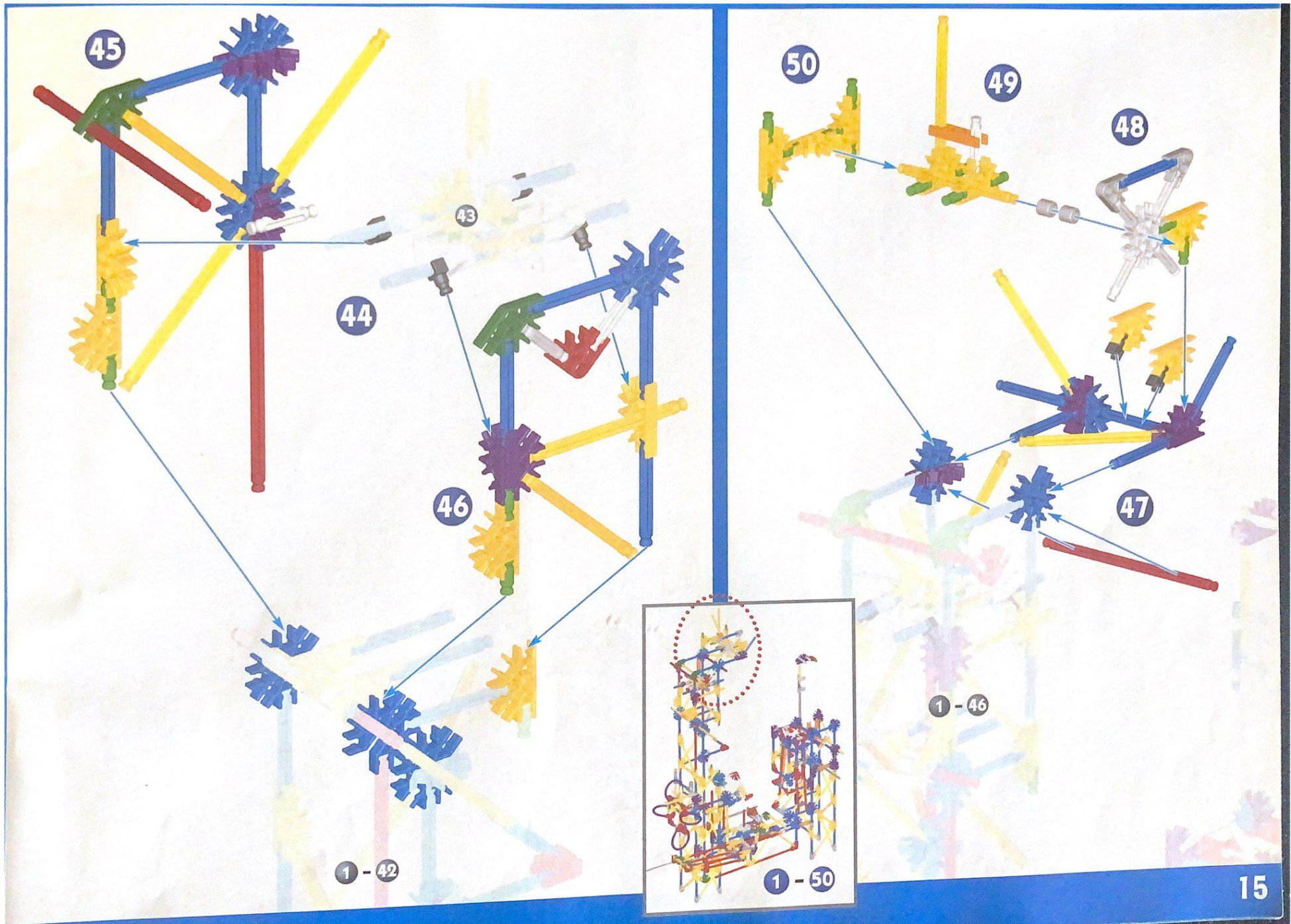

1 - 50

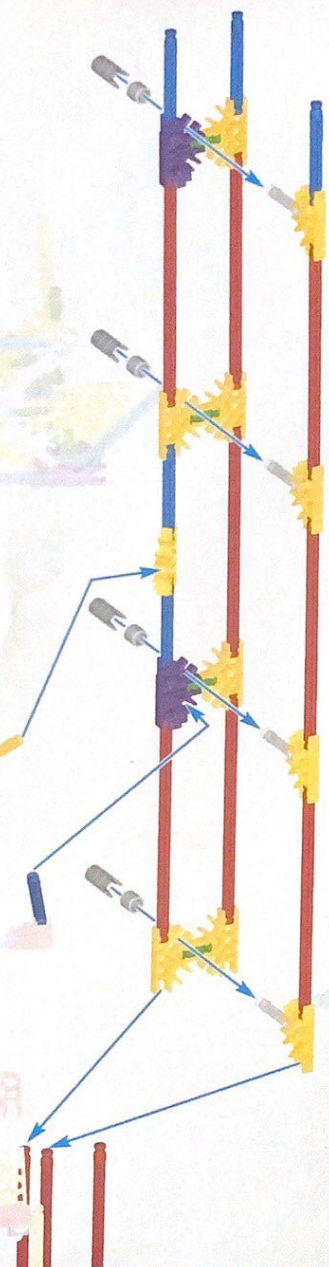

51

52

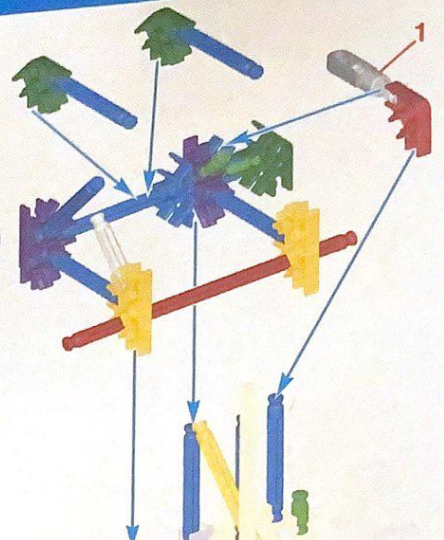

1 - 51

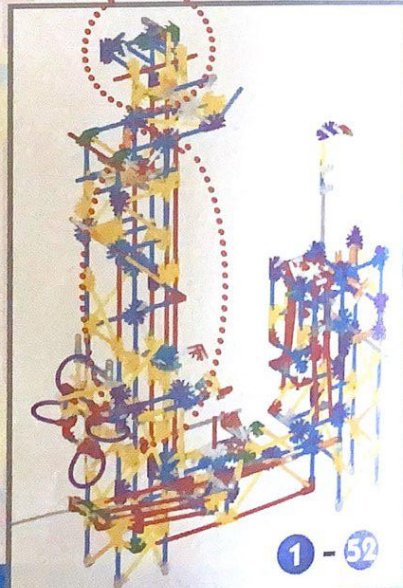

1 - 52

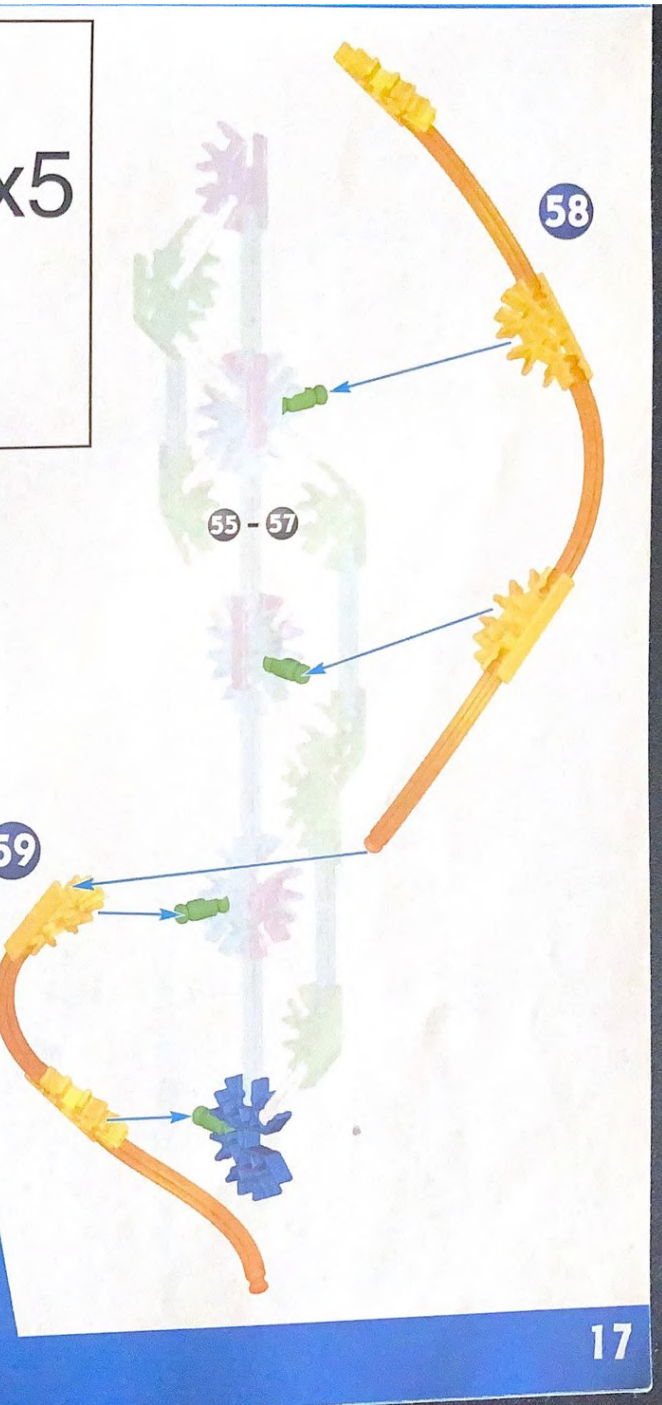
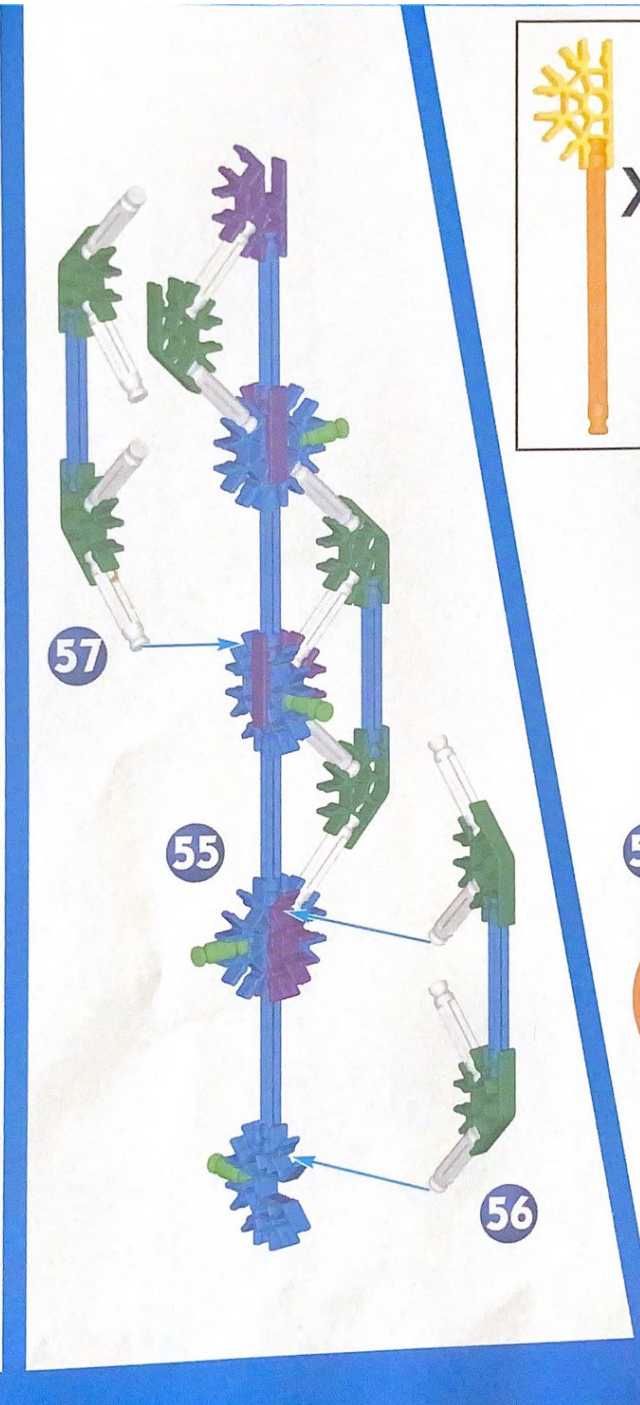

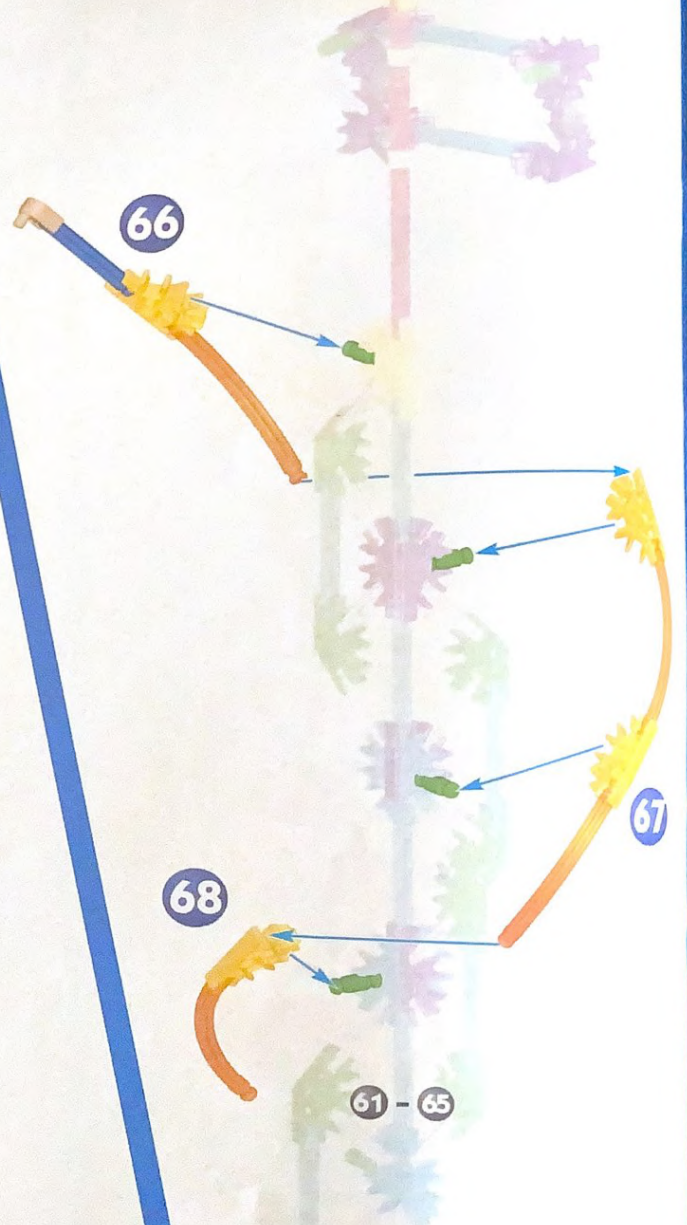
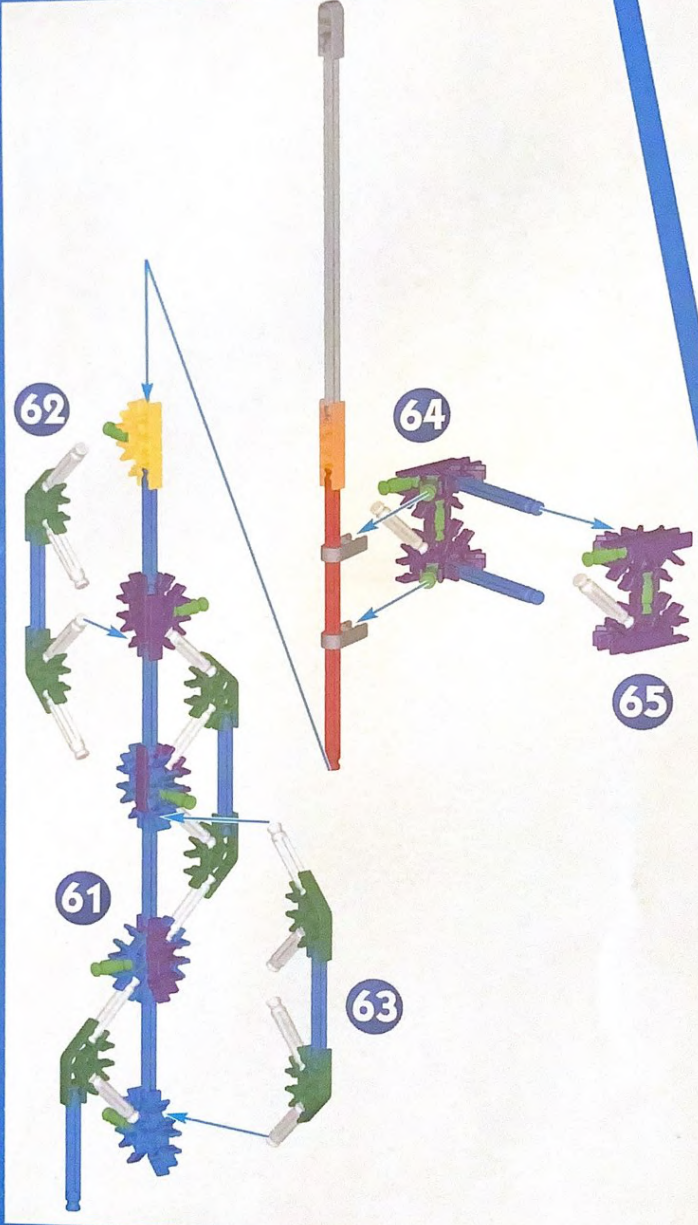

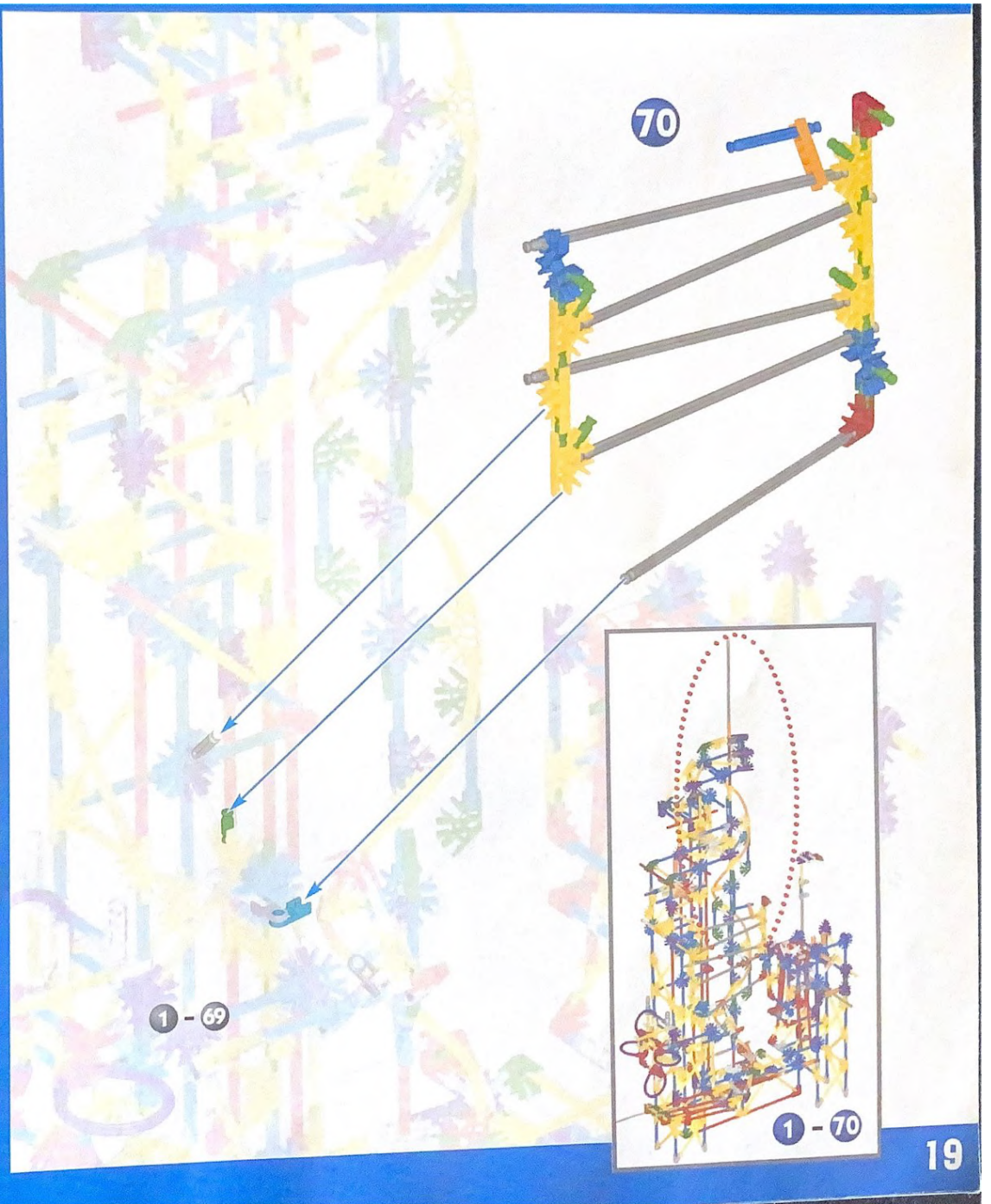



1 - 70

71

72

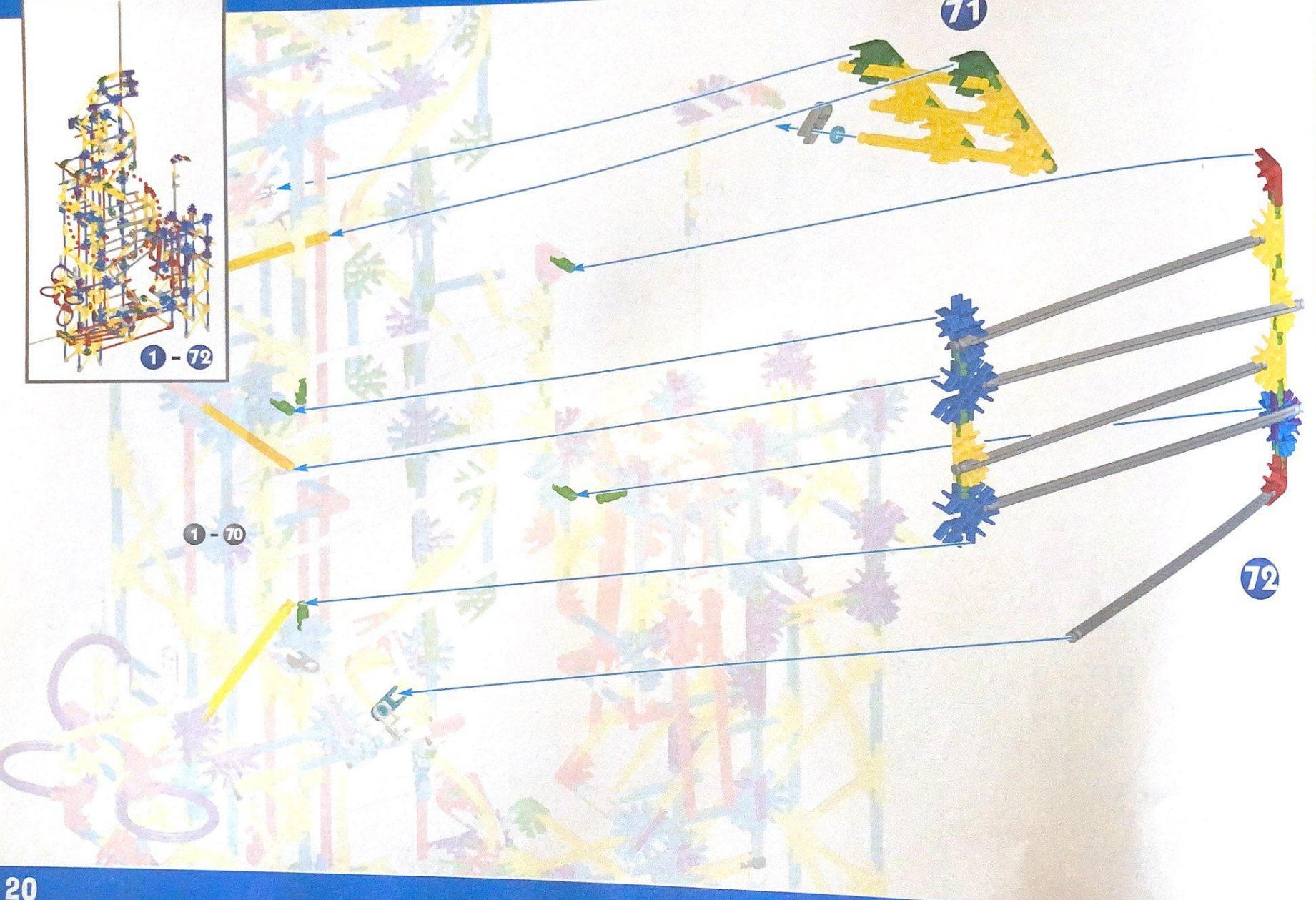

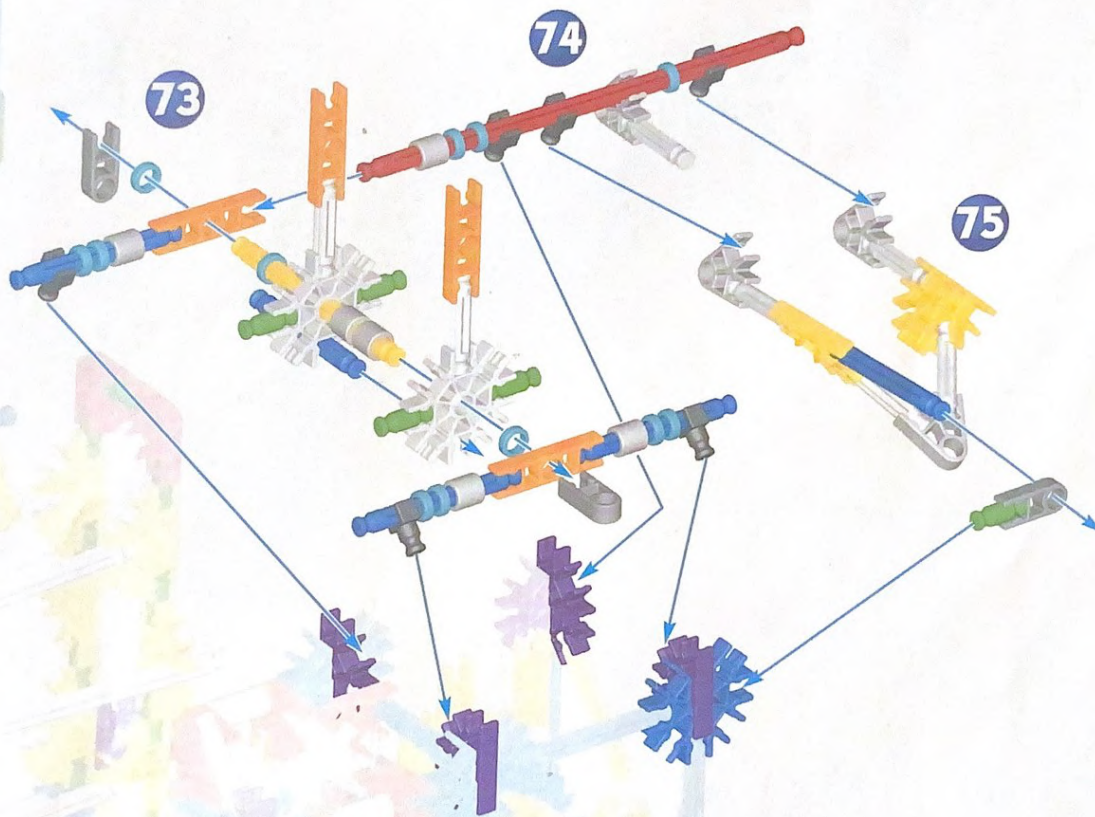

1 - 72

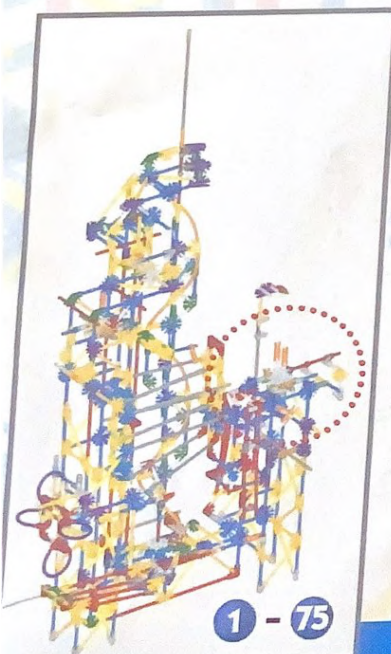

1 - 75



1 - 75

76

77

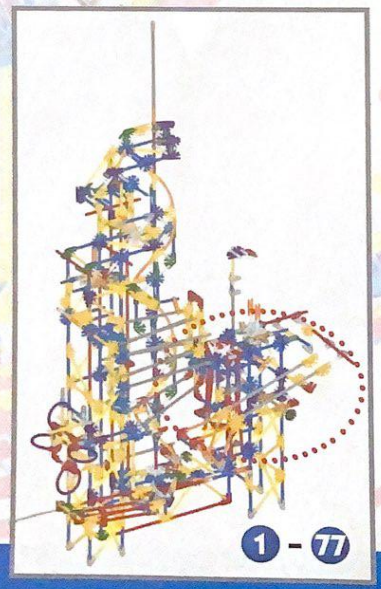

1 - 77

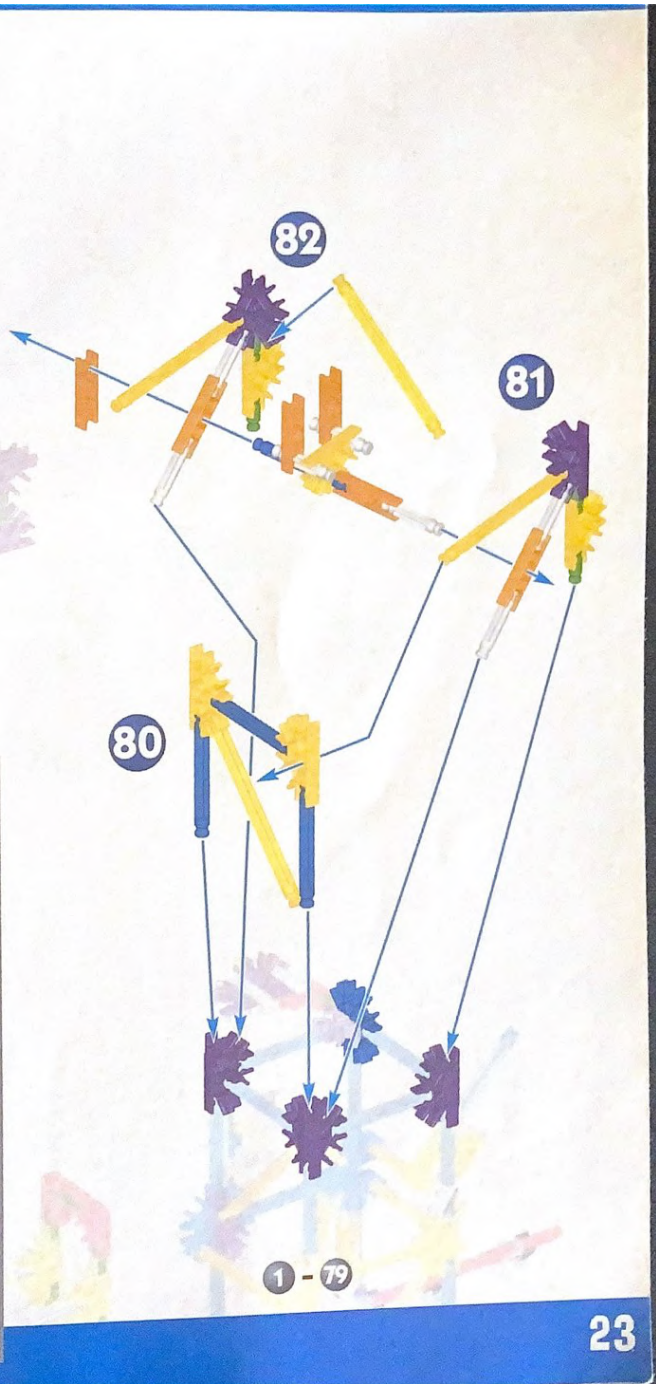
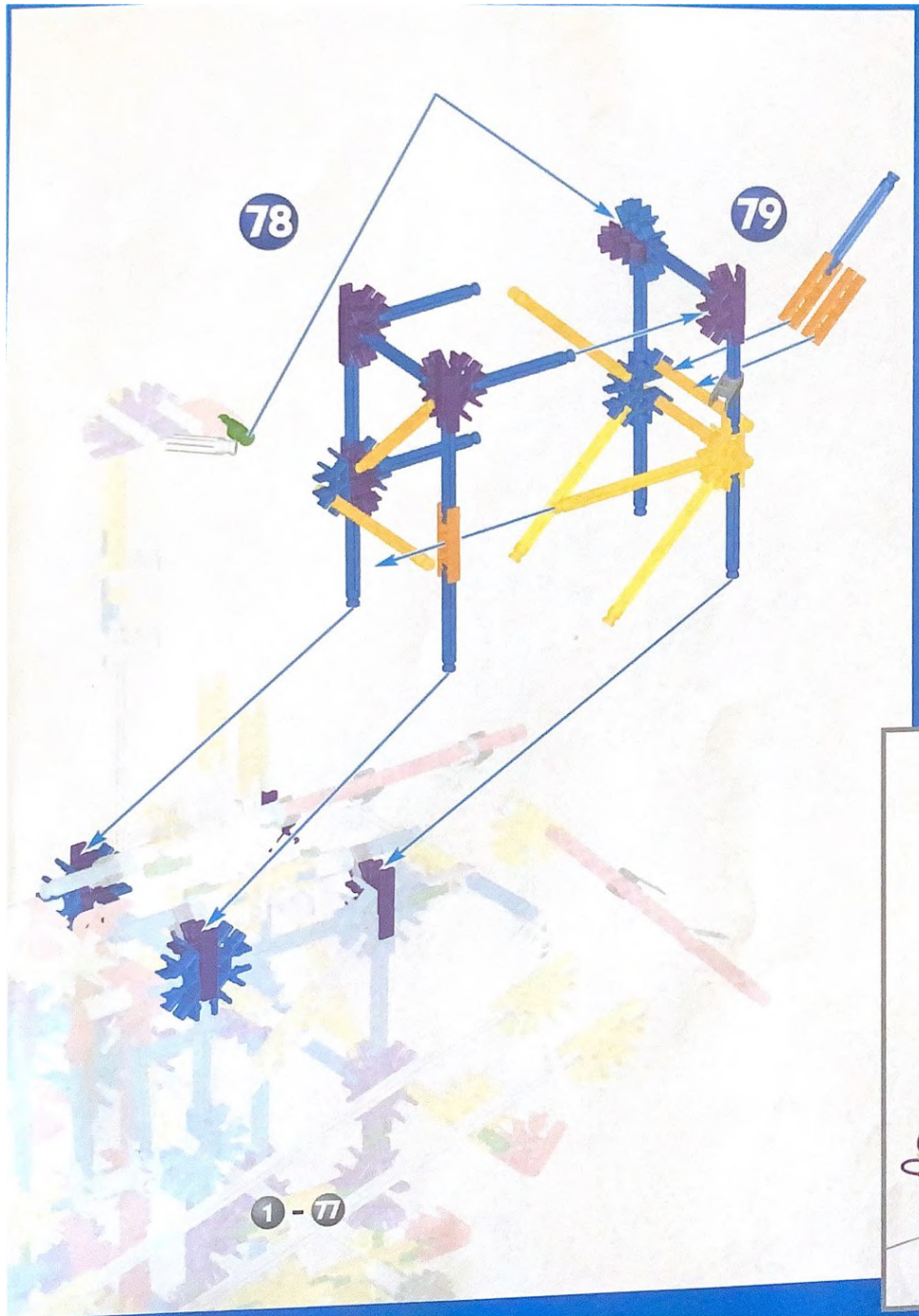

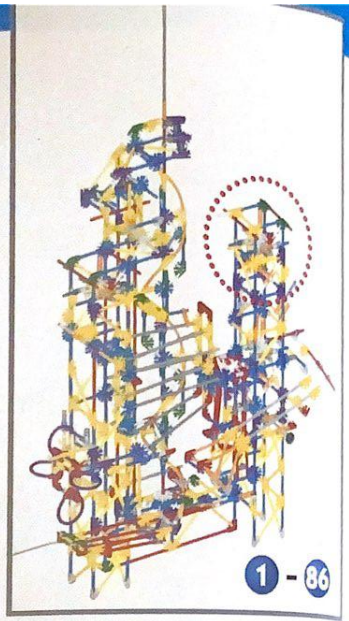
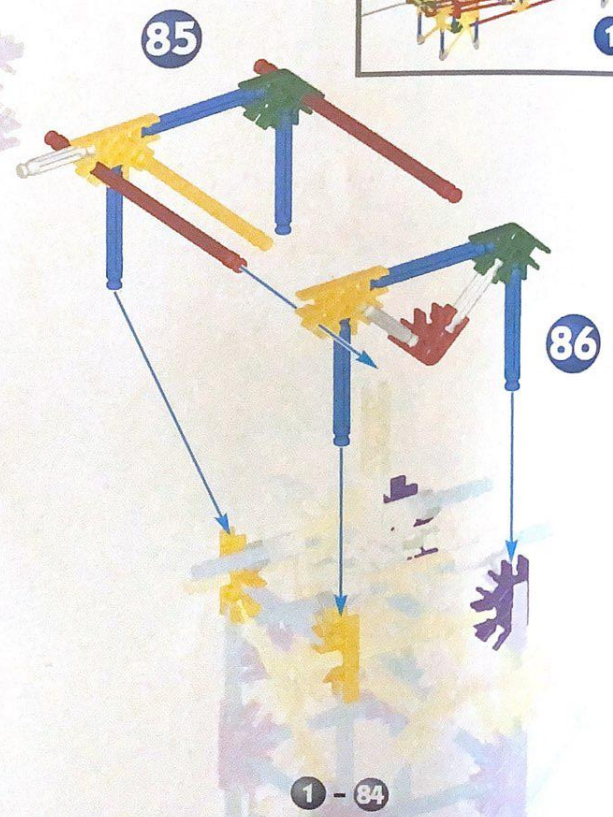

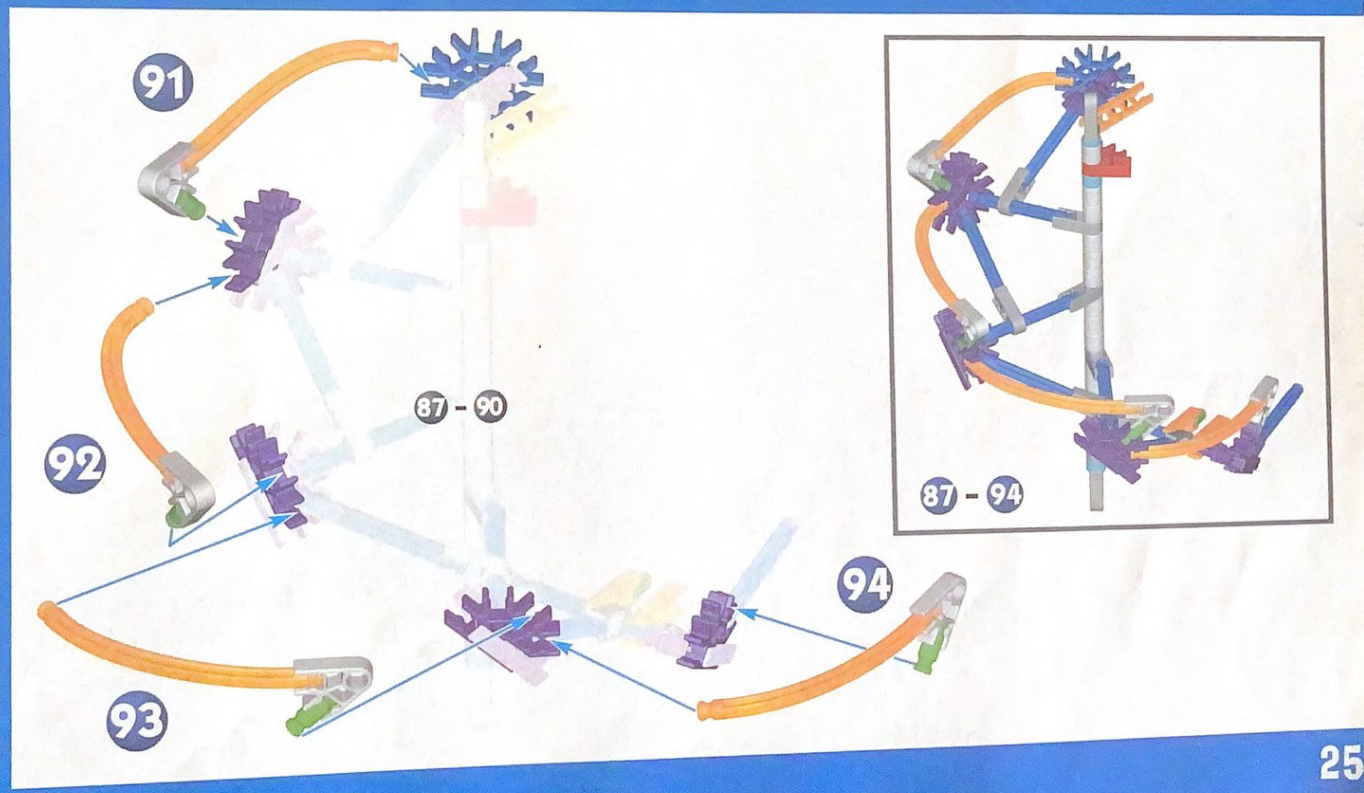
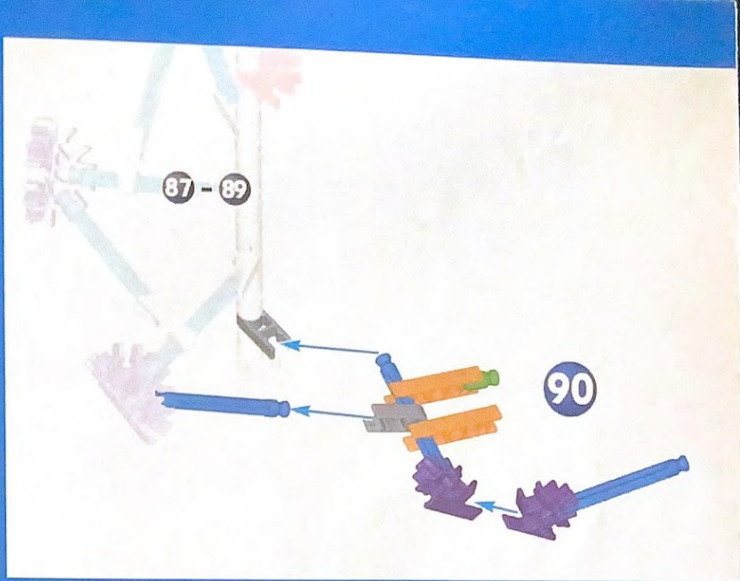
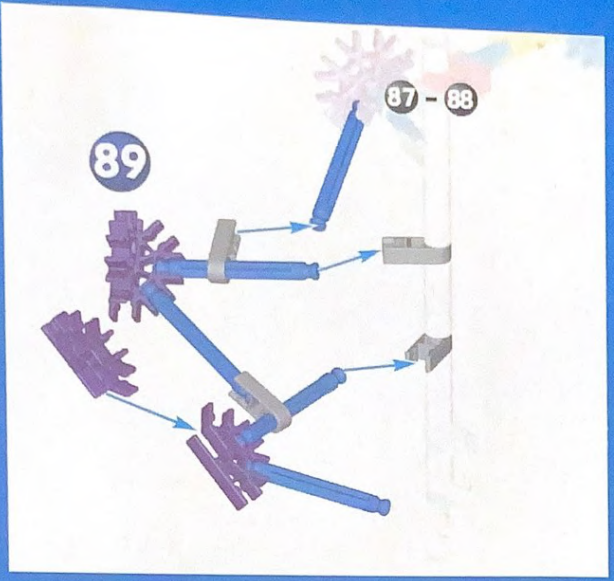
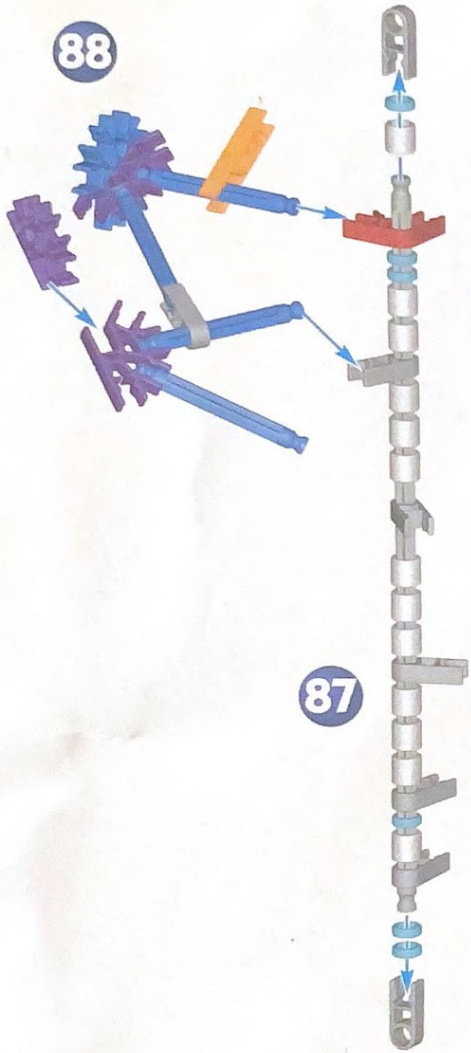

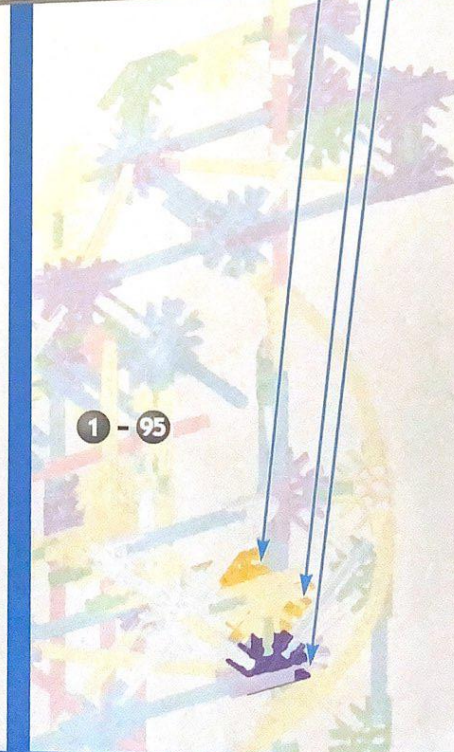
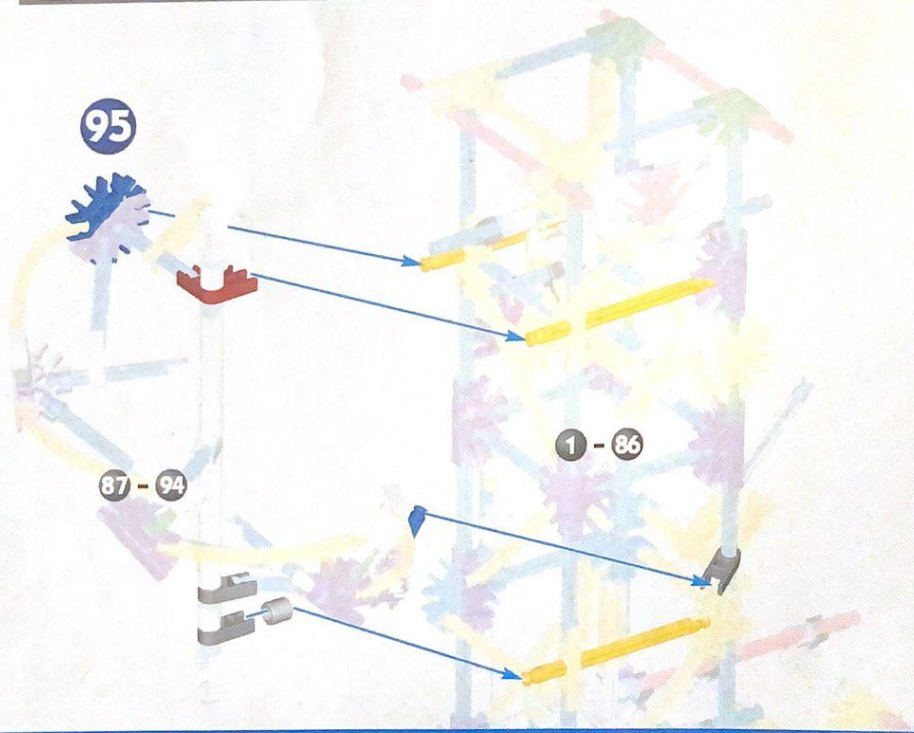
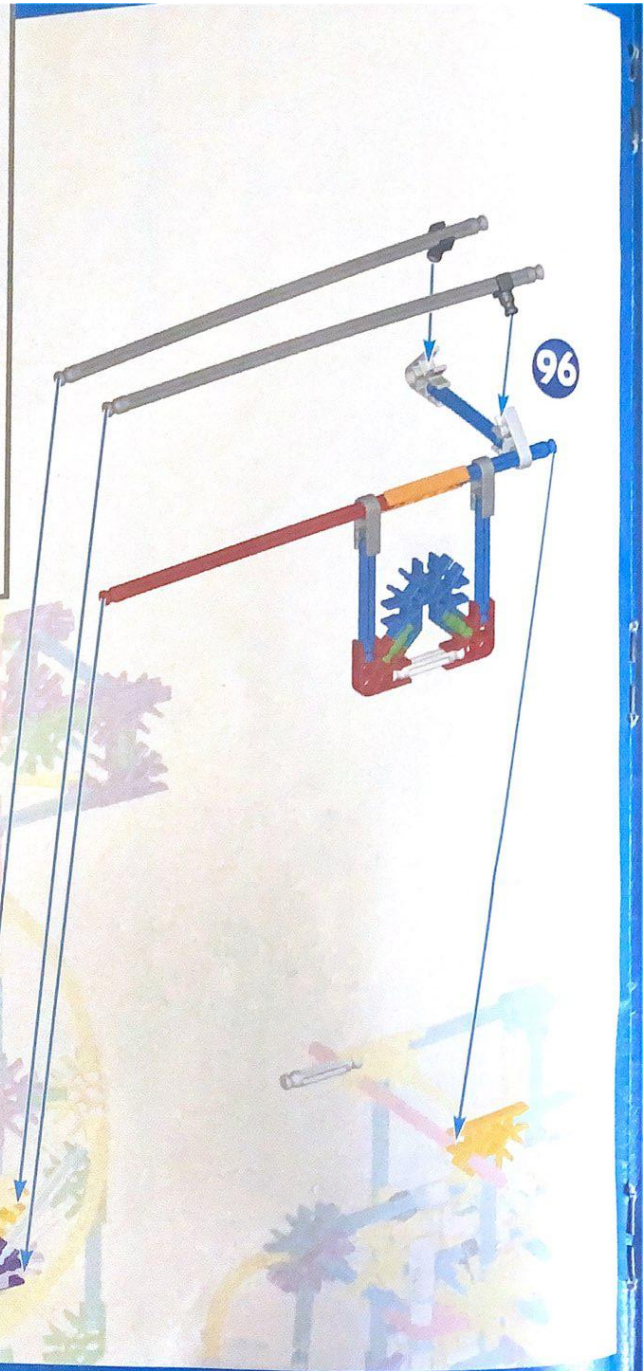
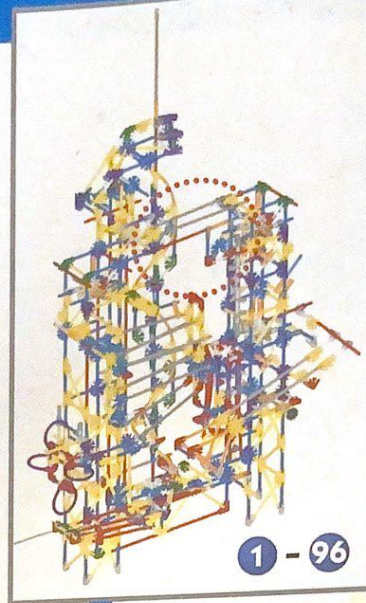
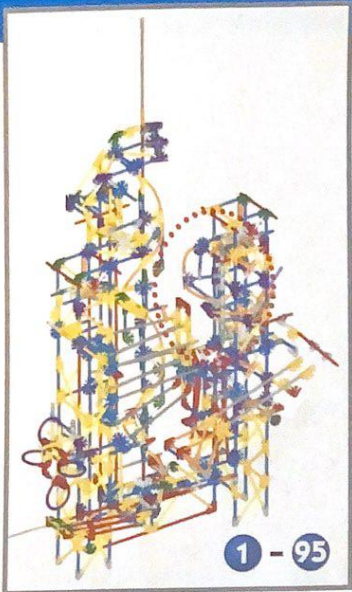

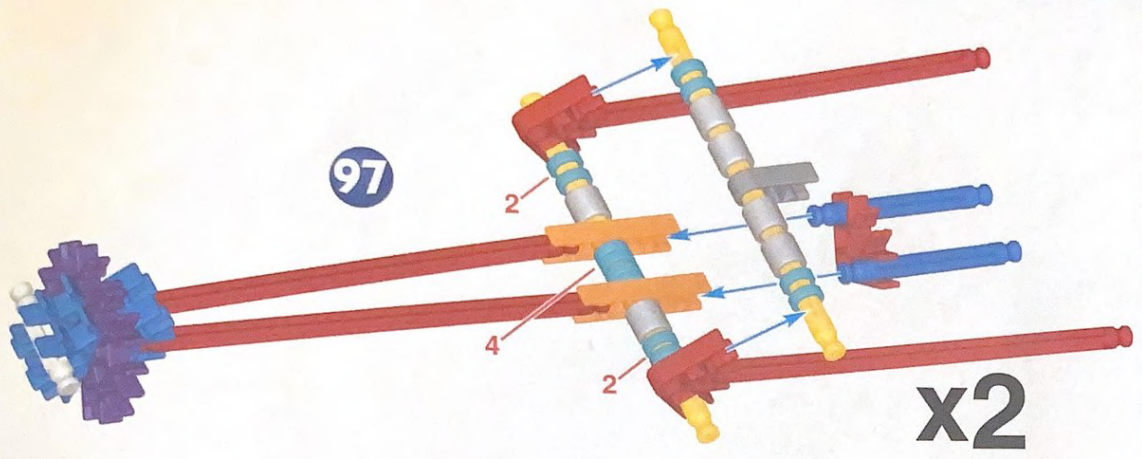

97

x2

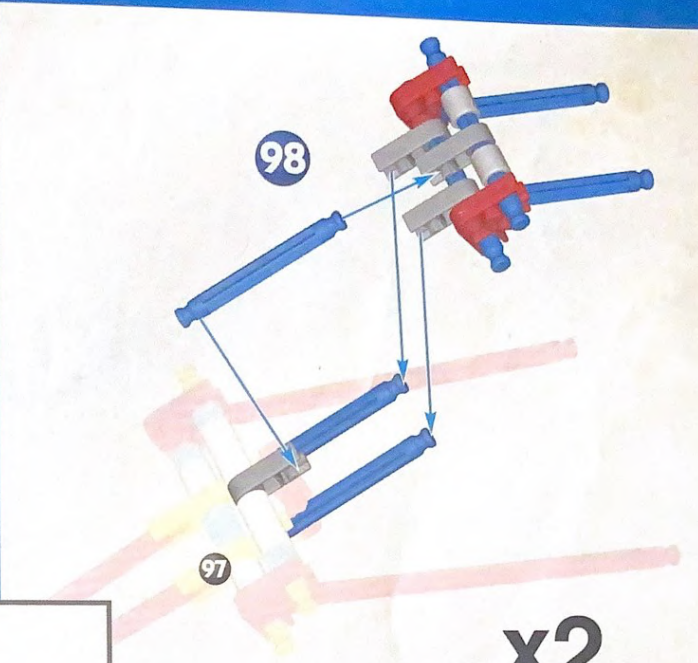

98

x2

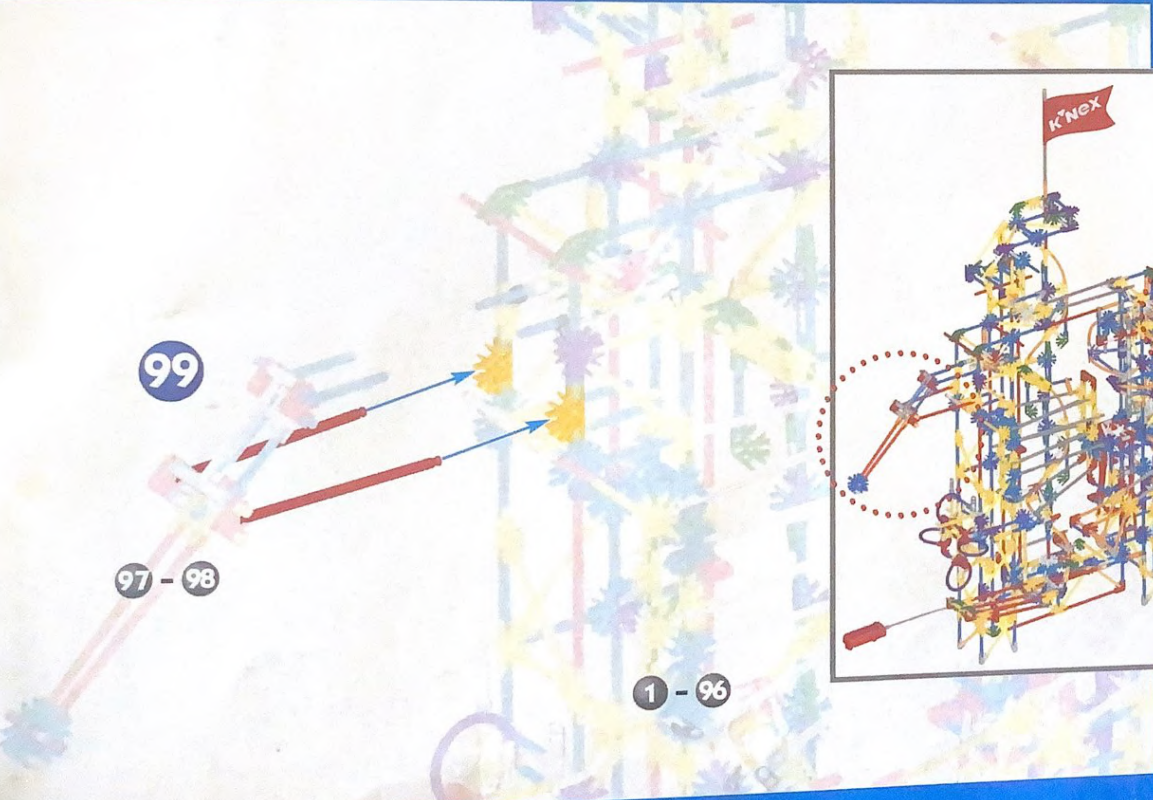

99

97 - 98

1 - 96

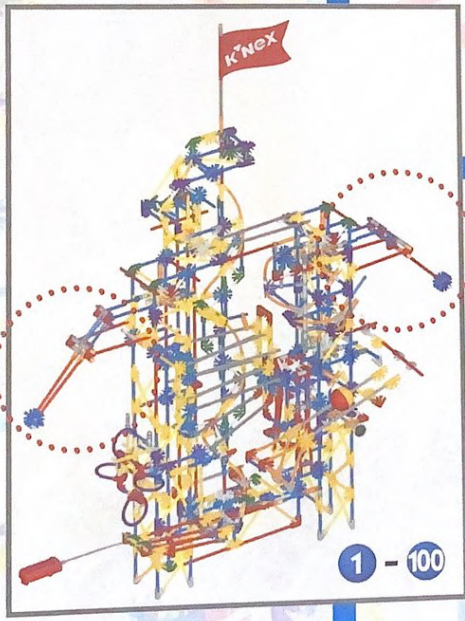

1 - 100

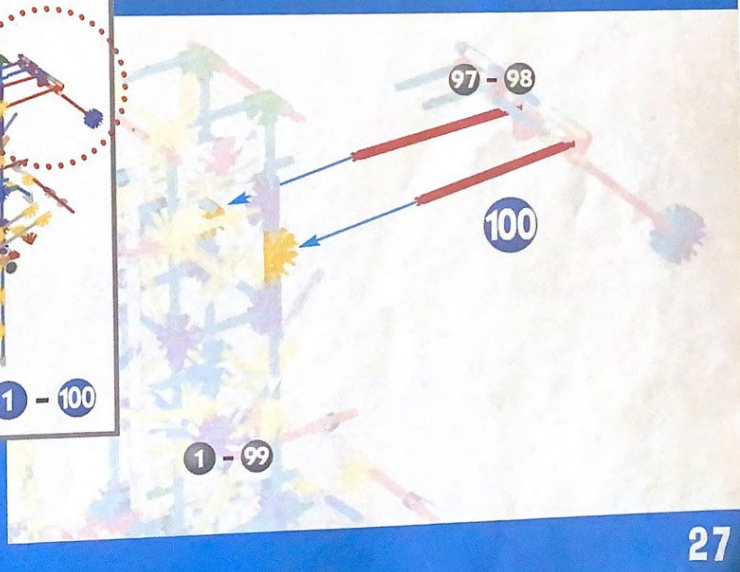

97 - 98

100

1 - 99

KRISS-KROSS

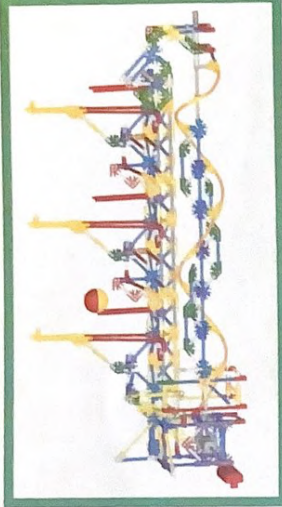

1

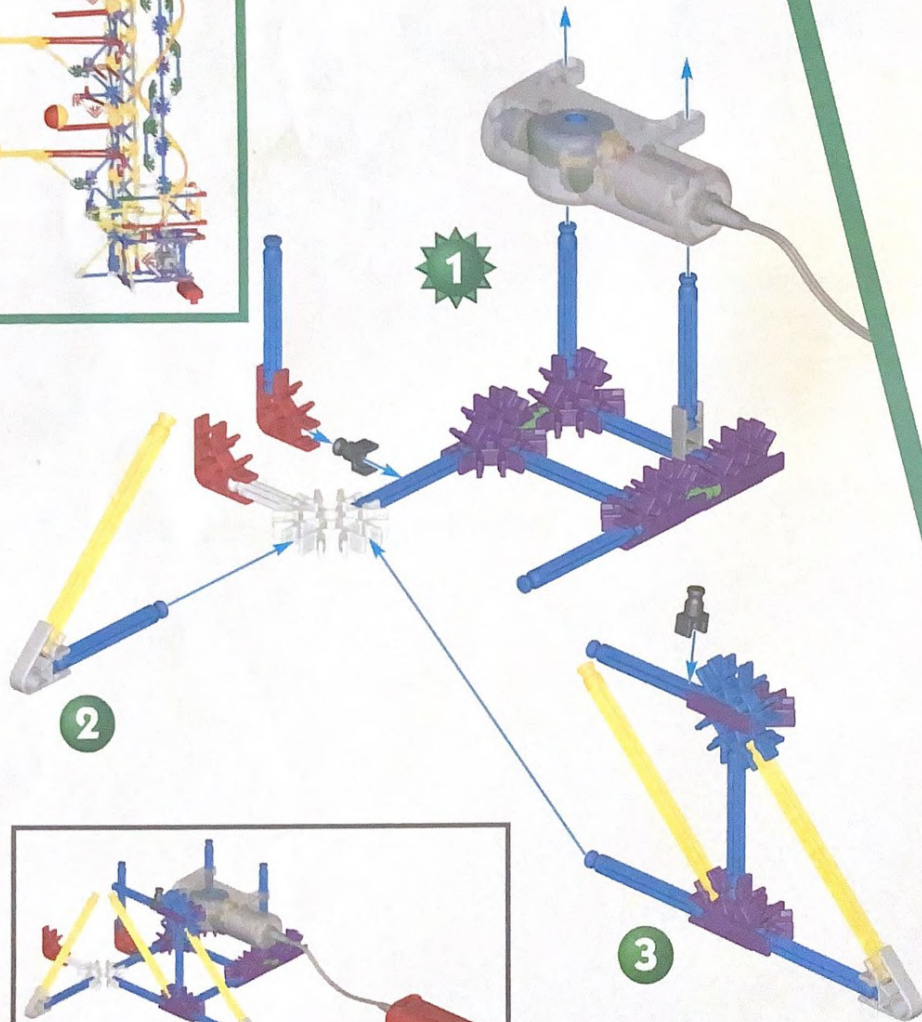

2

3

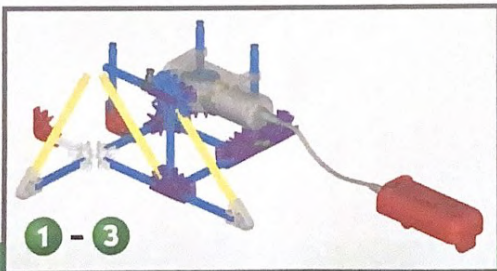

1 - 3

4

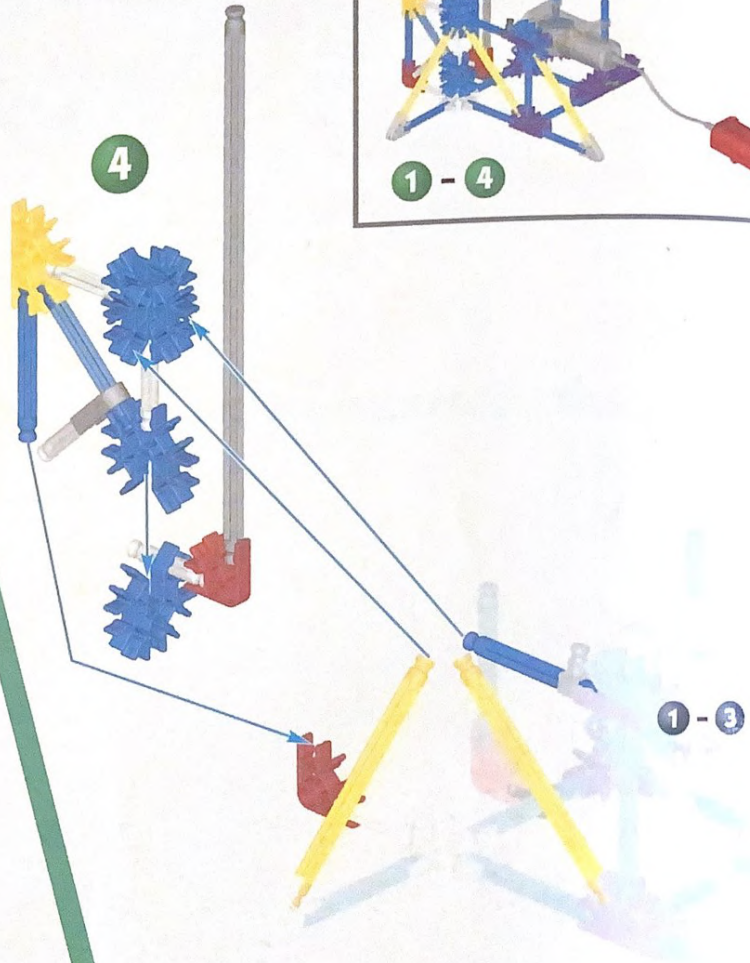

1 - 3

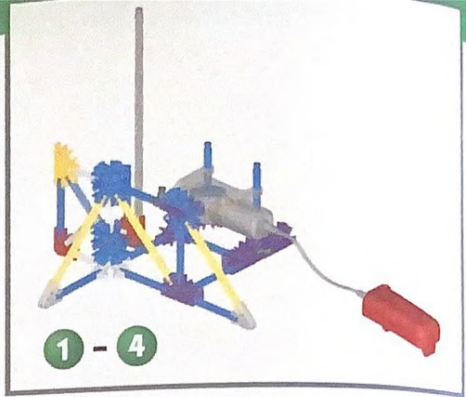

1 - 4

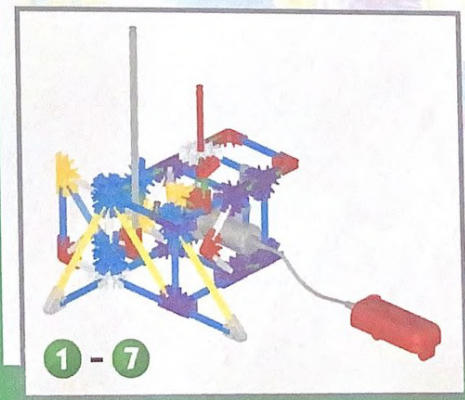
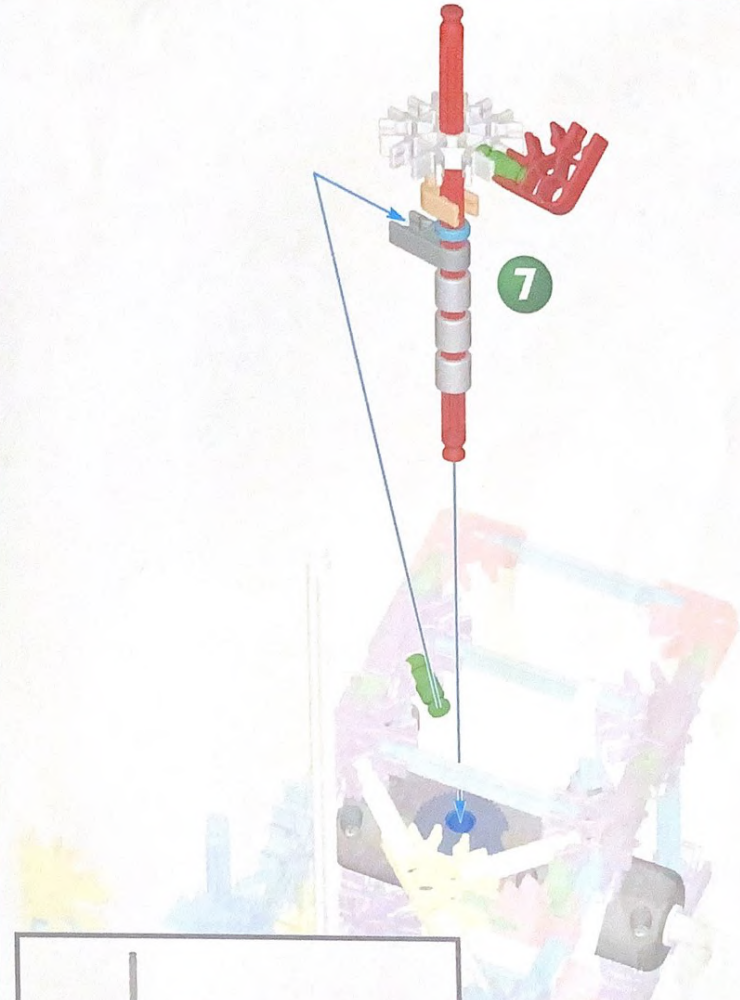
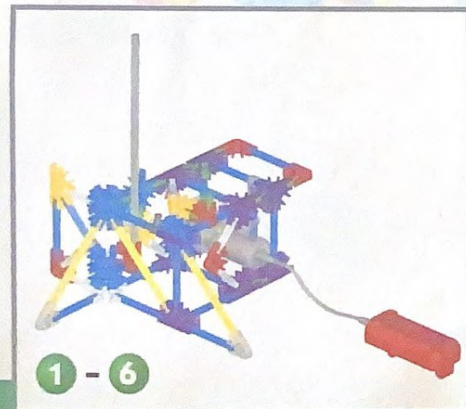
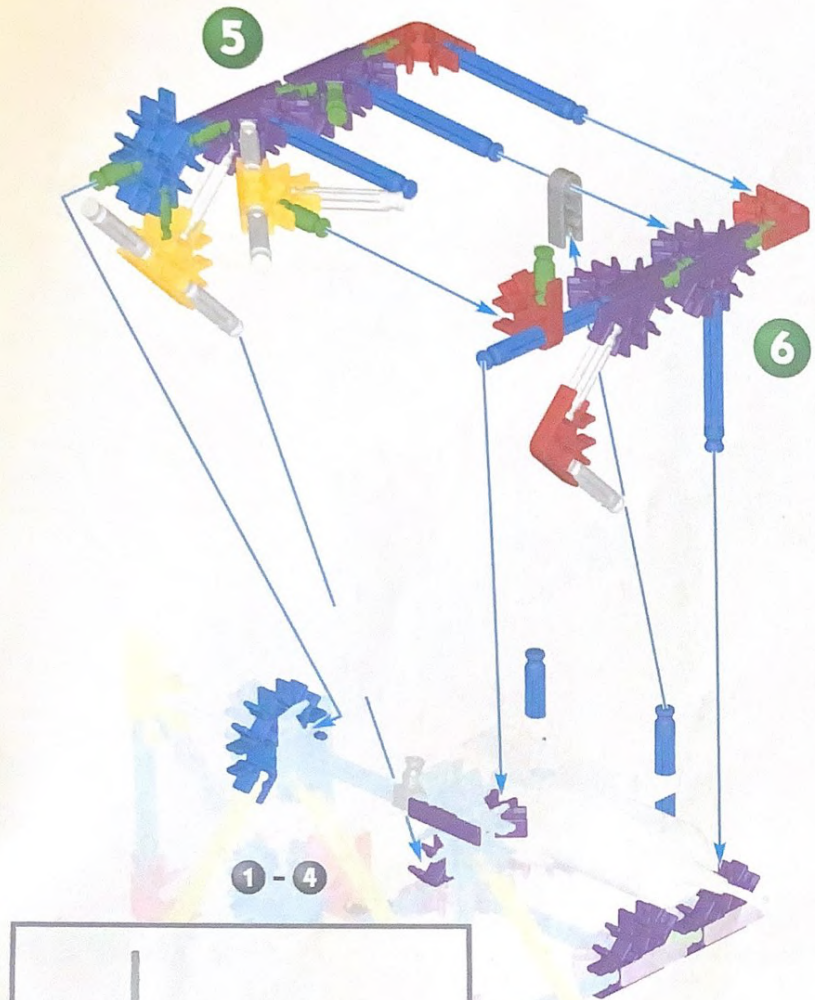

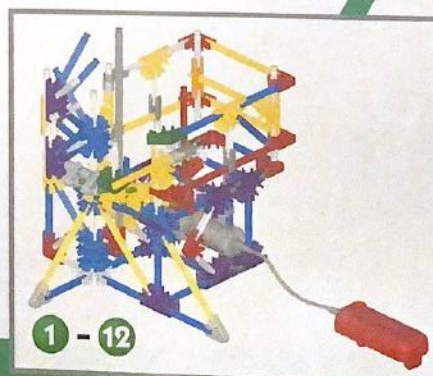
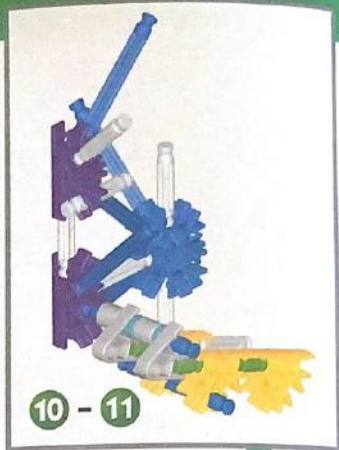
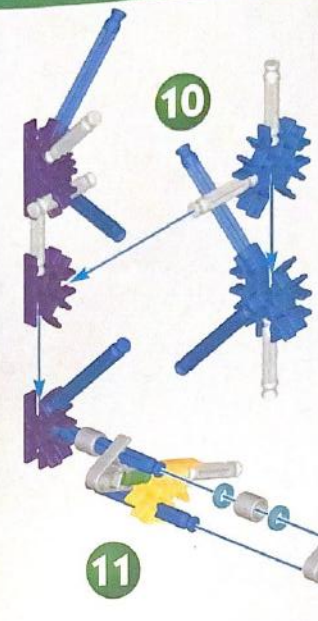
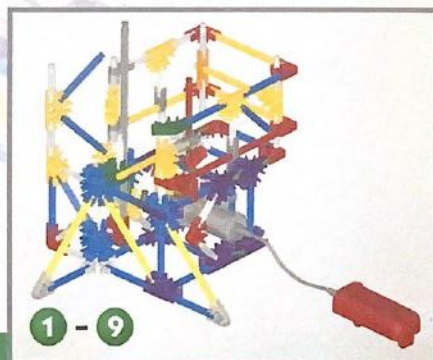
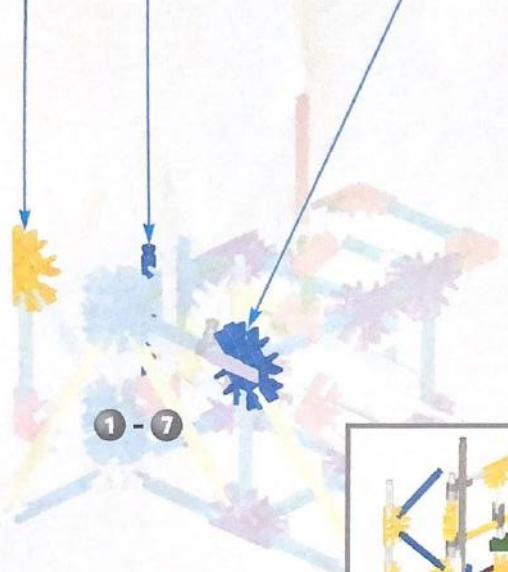
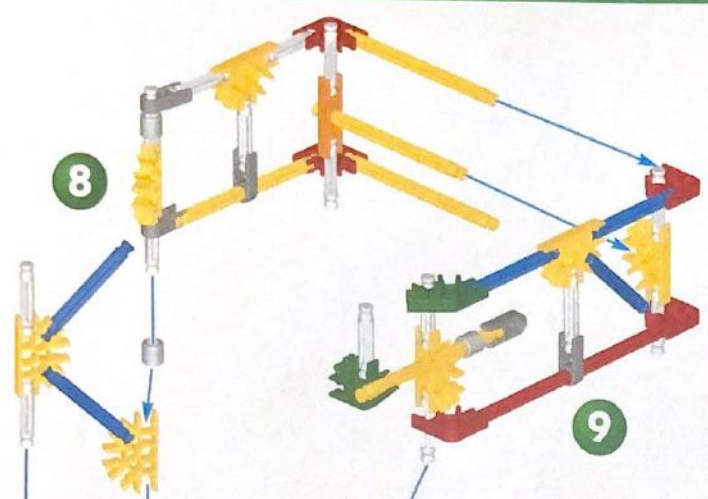

14

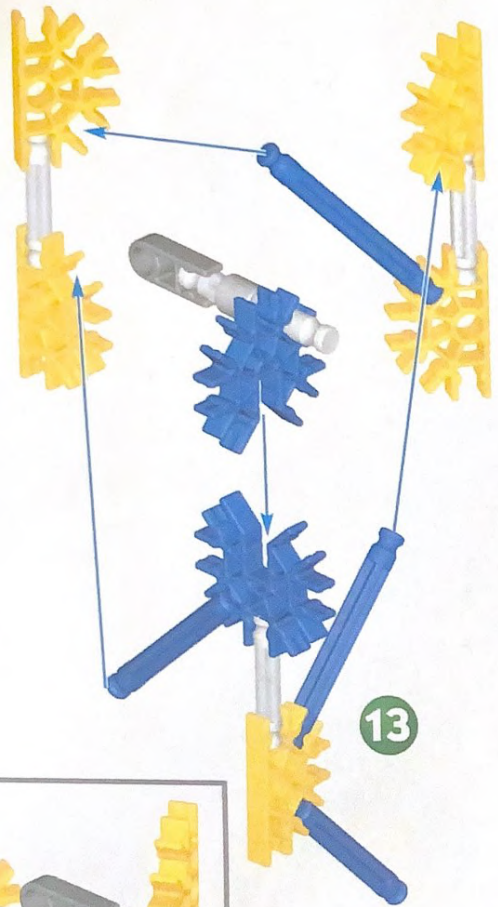

13



13 - 14

13 - 14

15

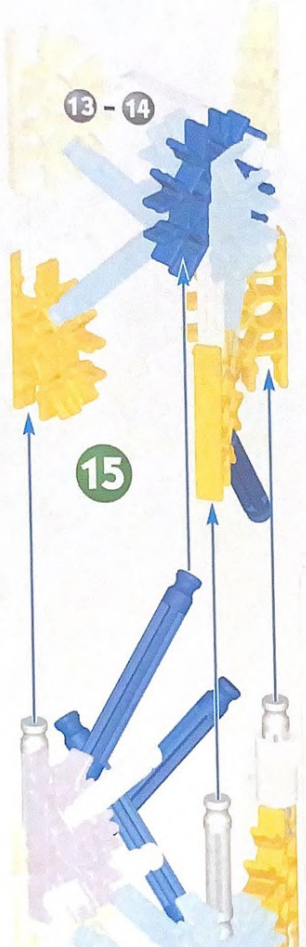

1 - 15



1 - 12



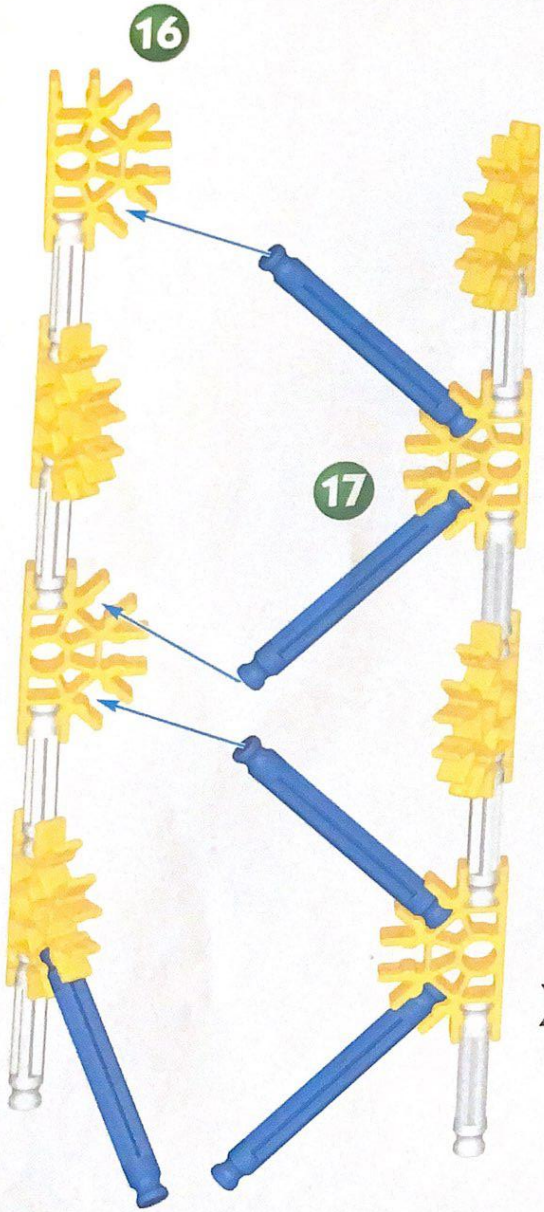

x2

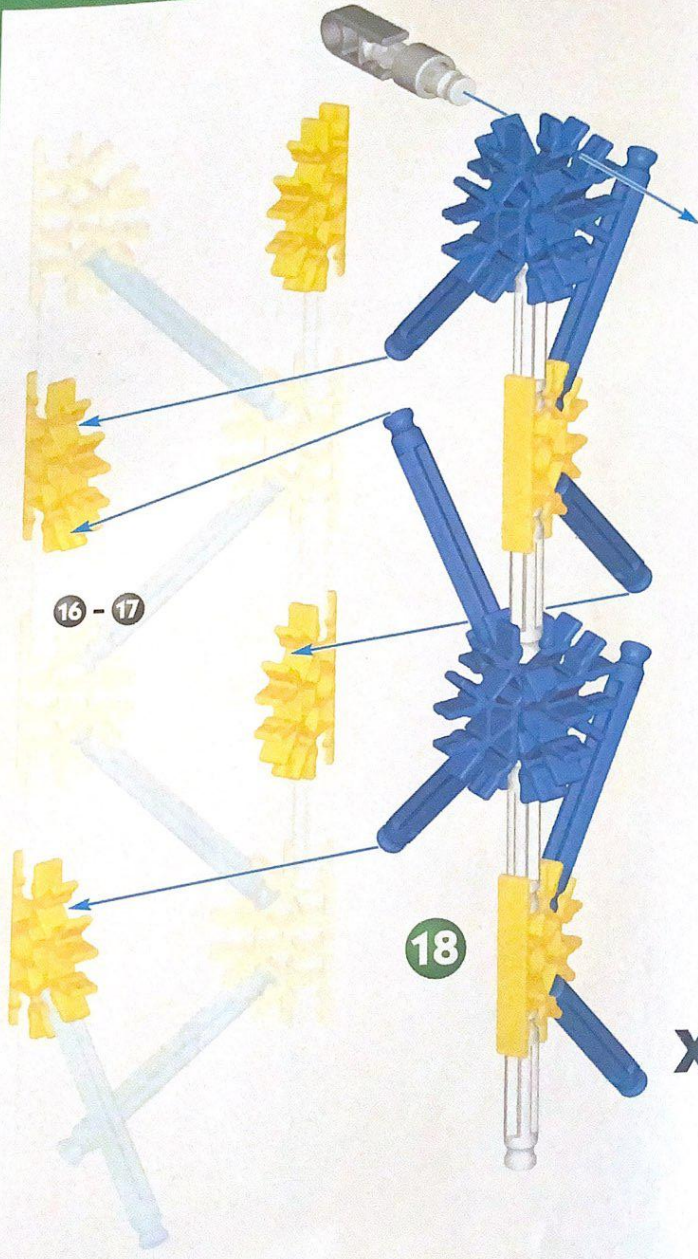
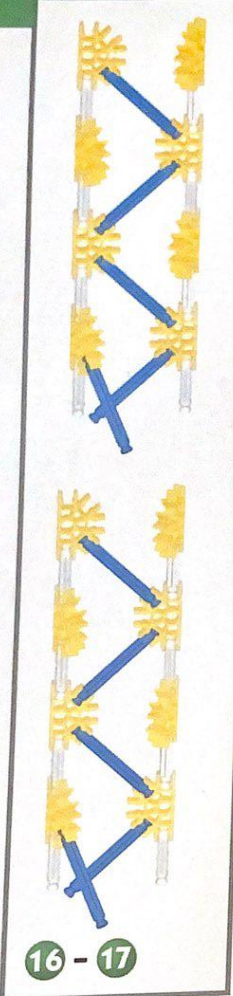

x2

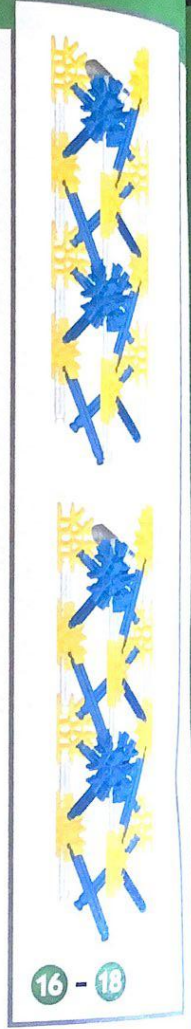

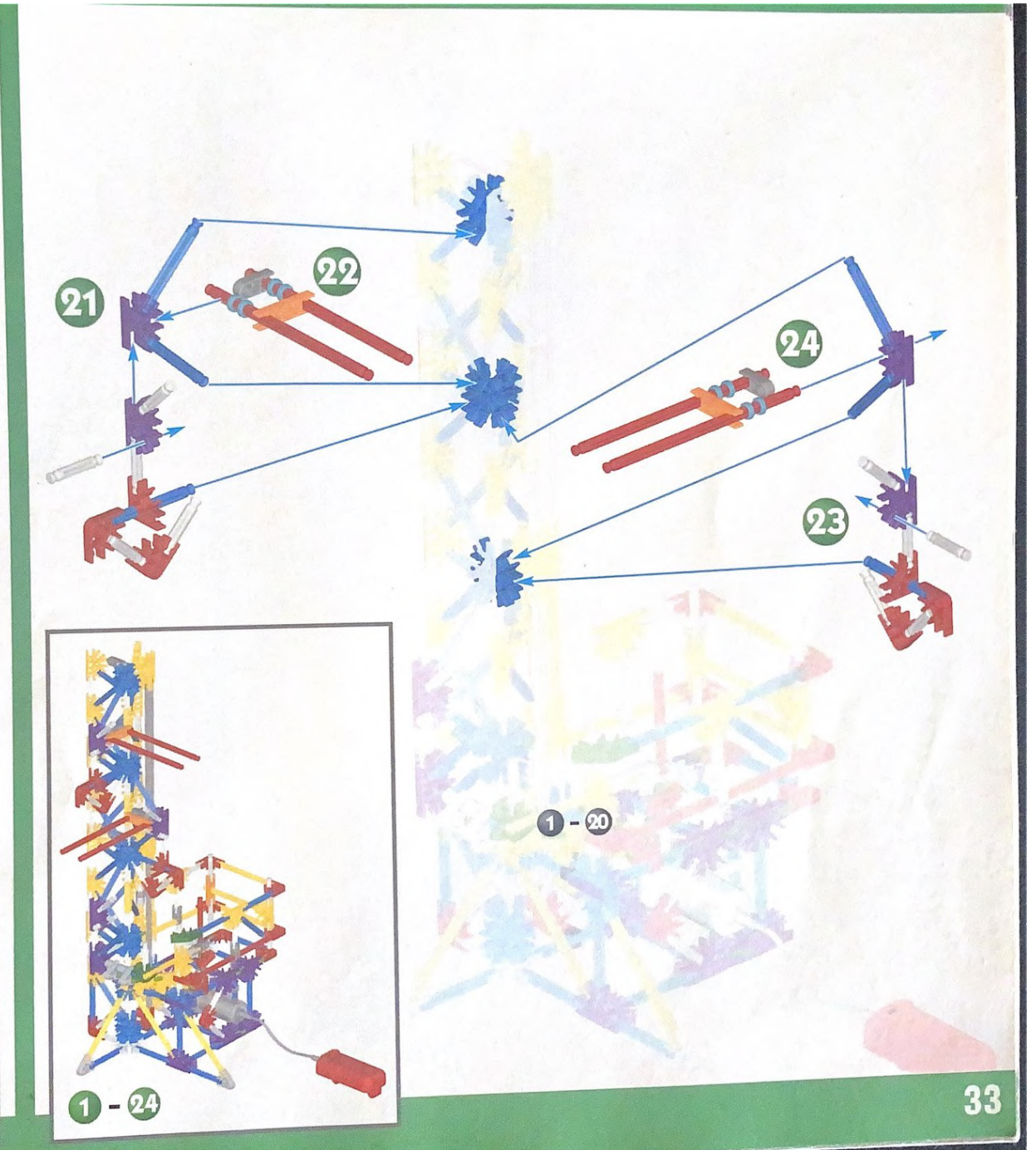
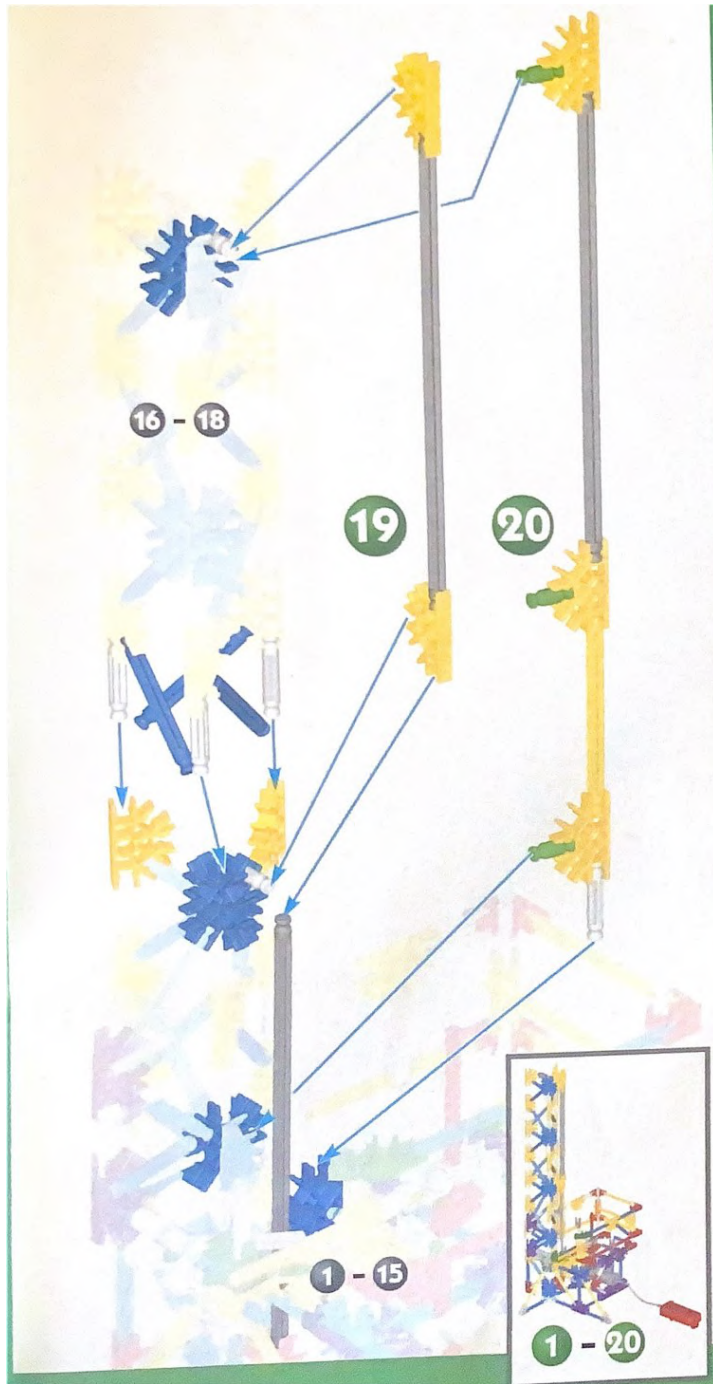

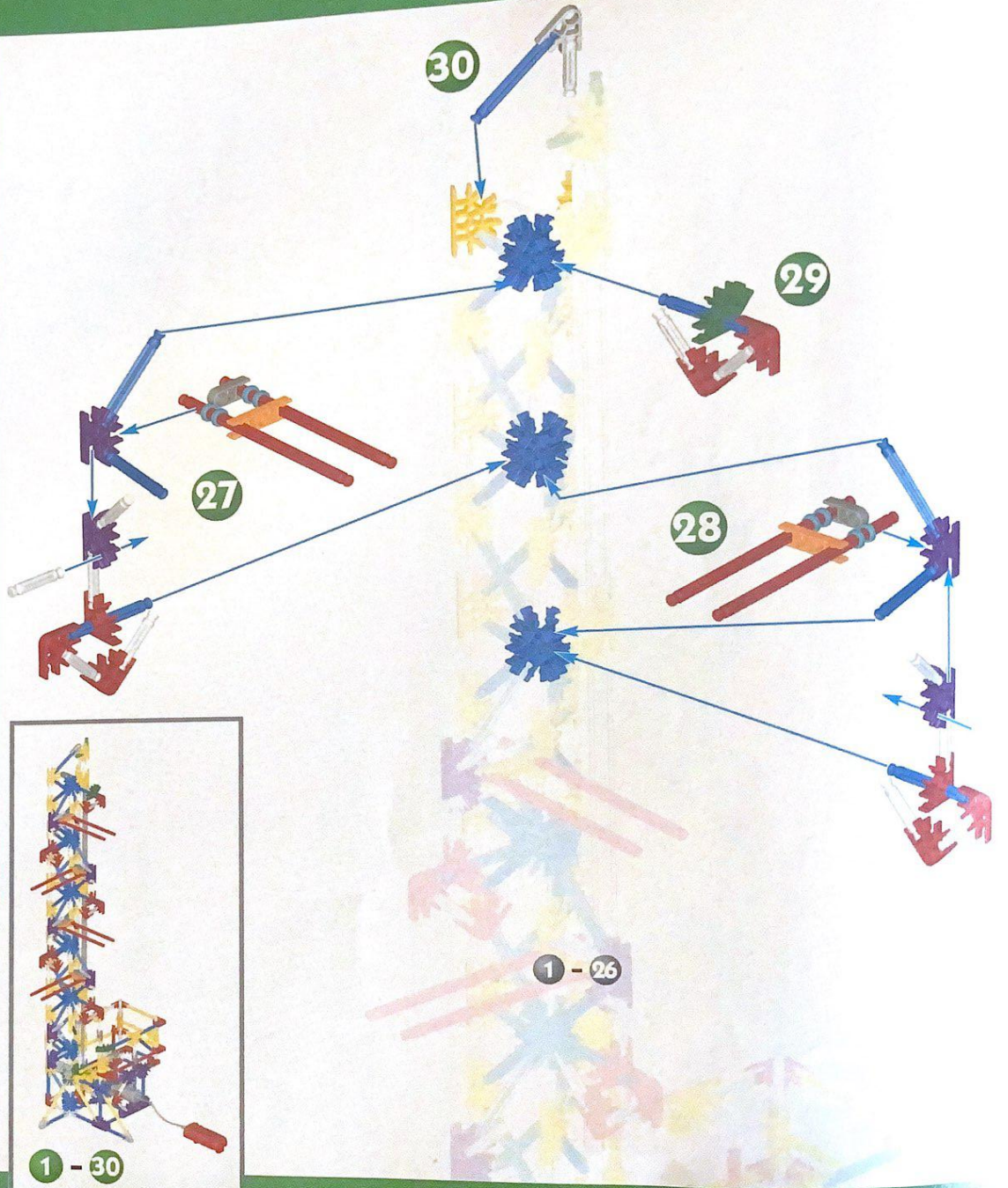
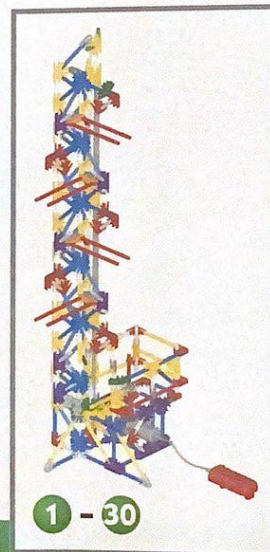
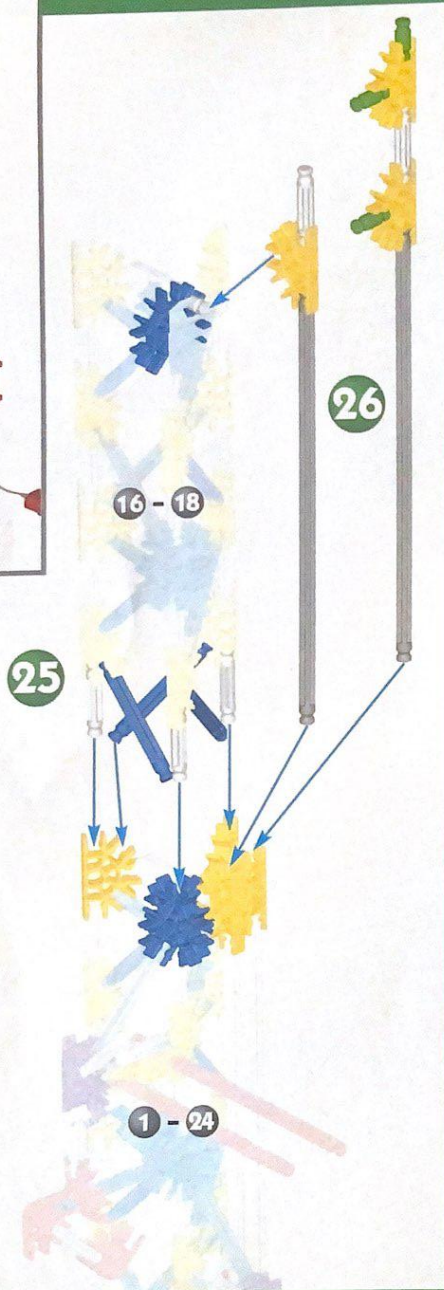
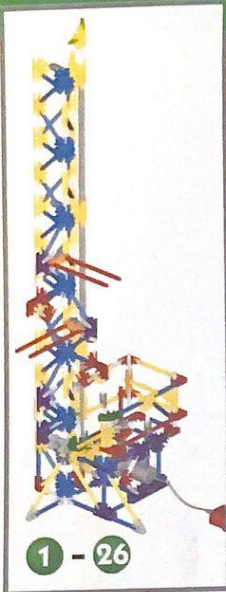

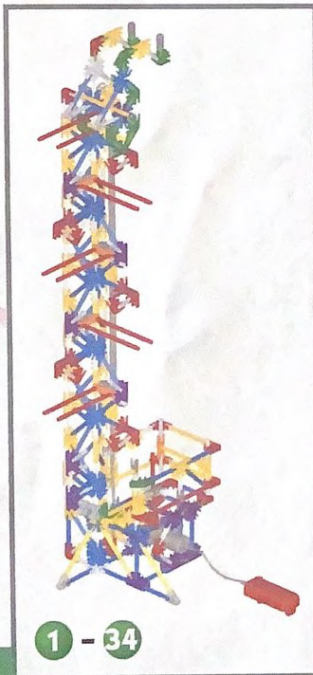
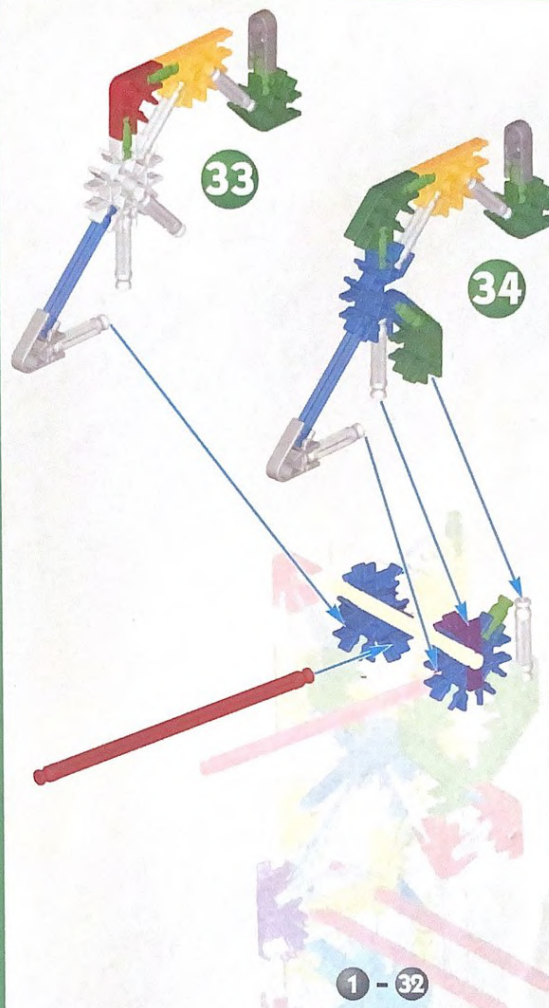
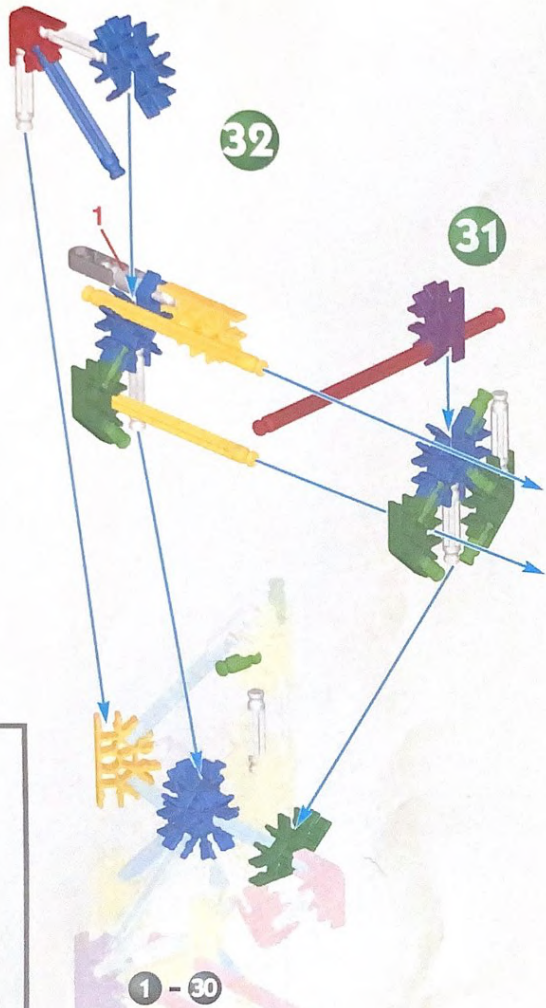
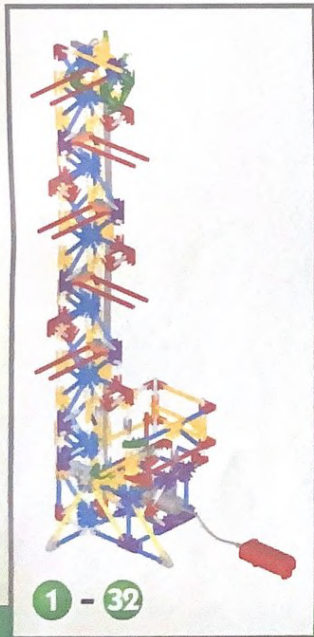

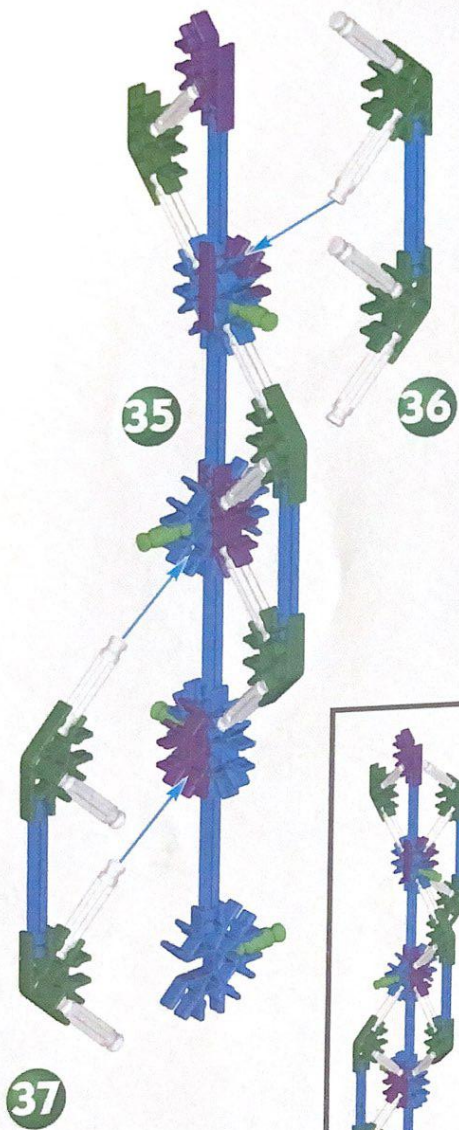

35 - 37

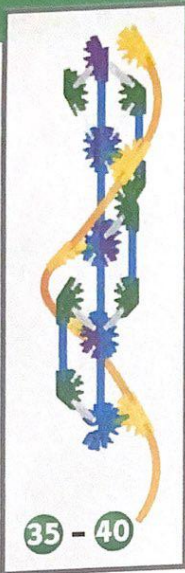

35 - 40

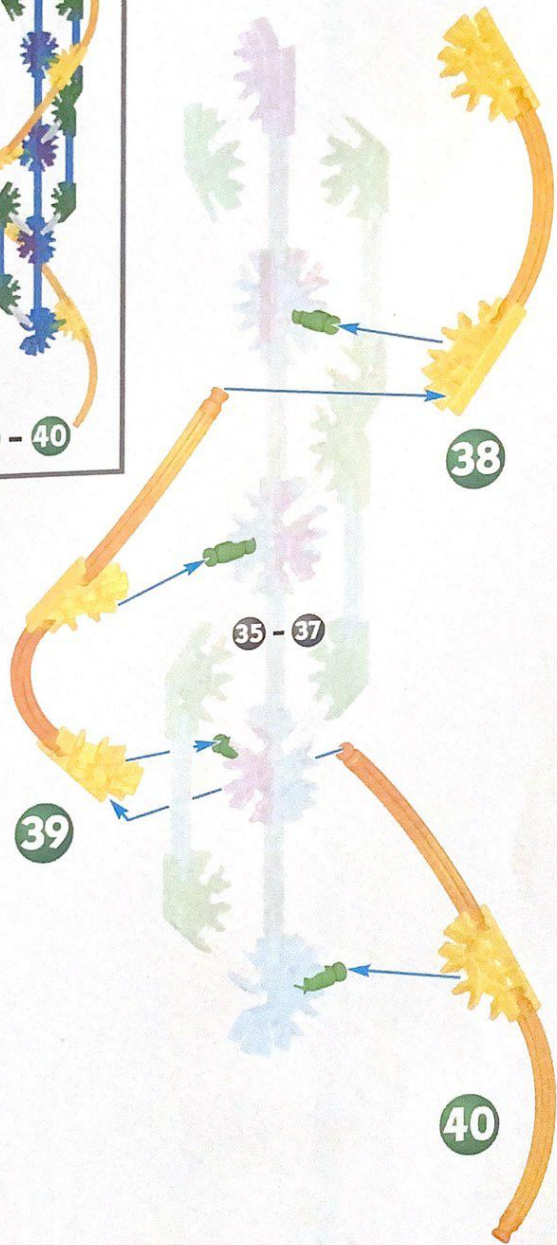

40

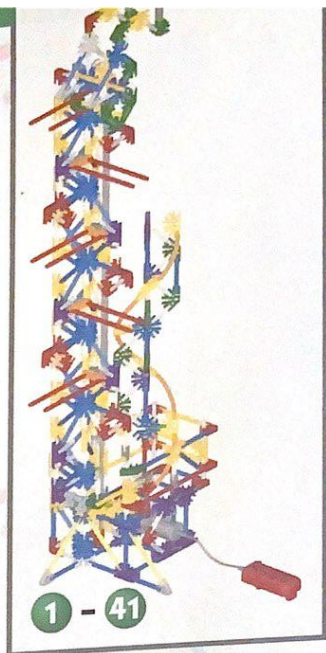

1 - 41



1 - 34

41

35 - 40

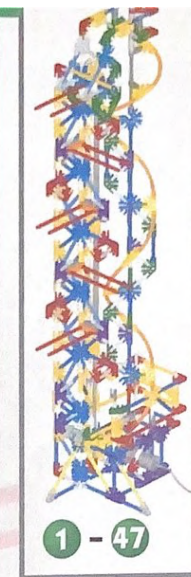
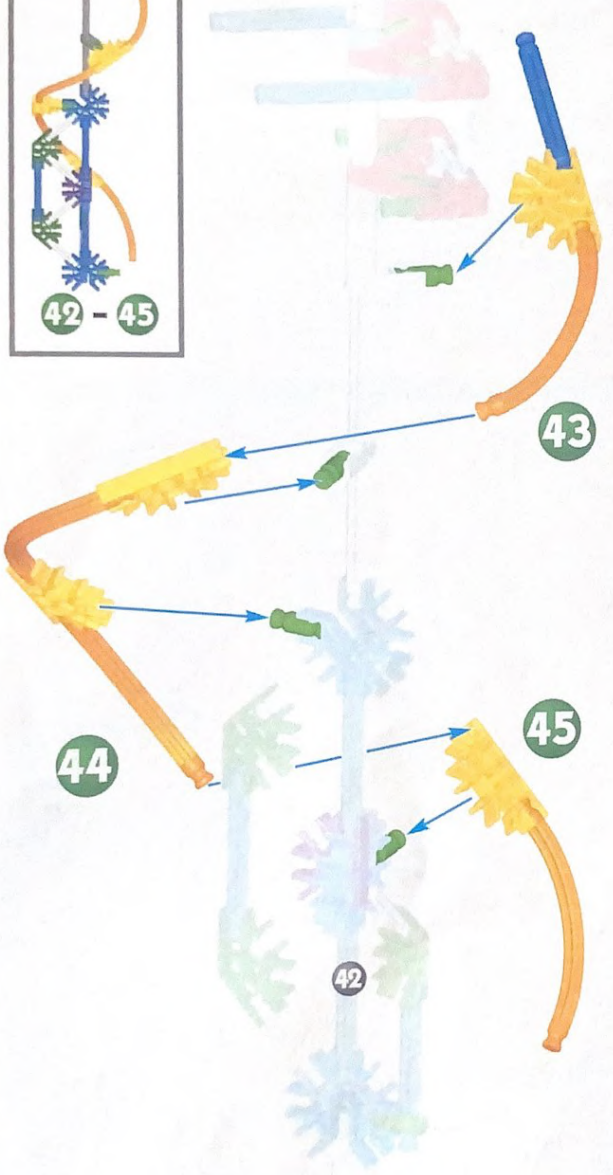
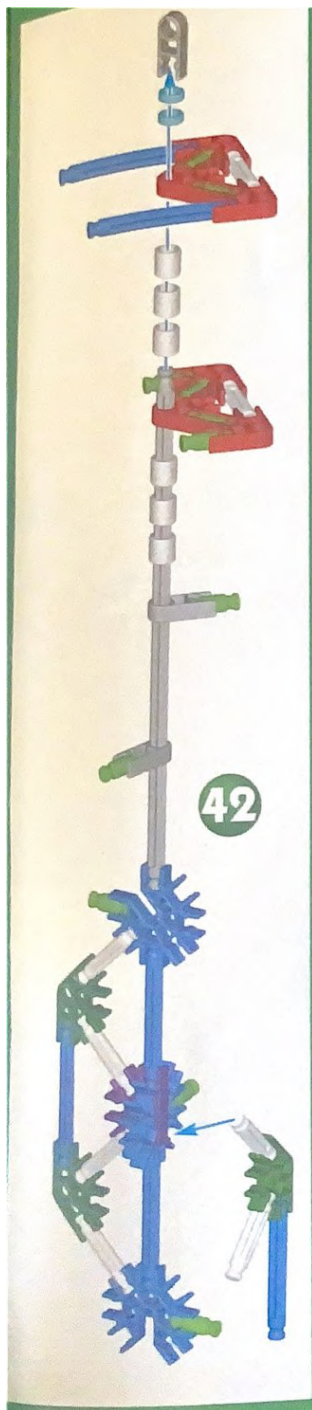

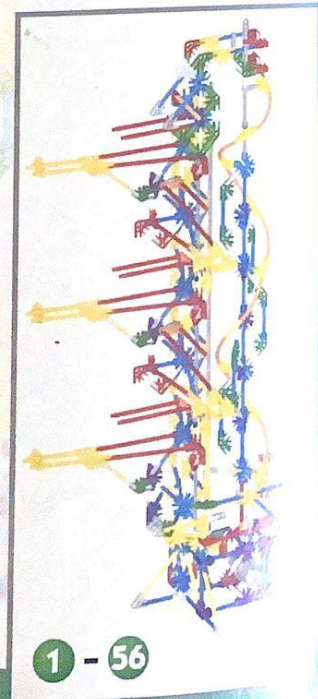
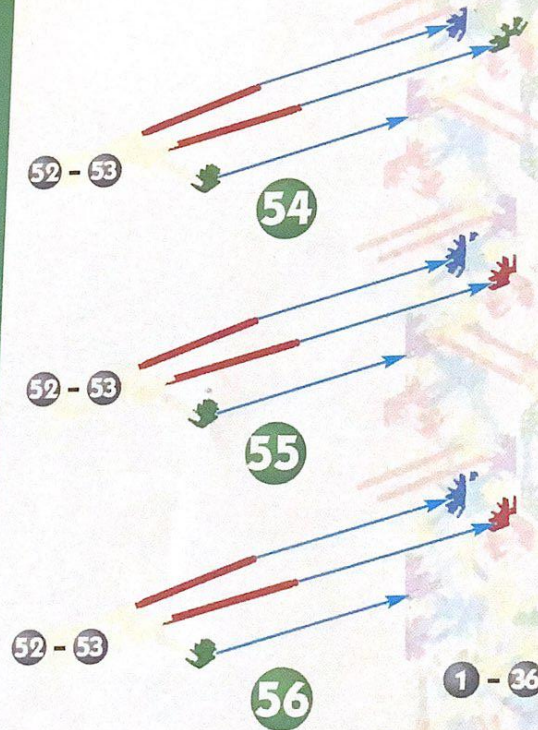
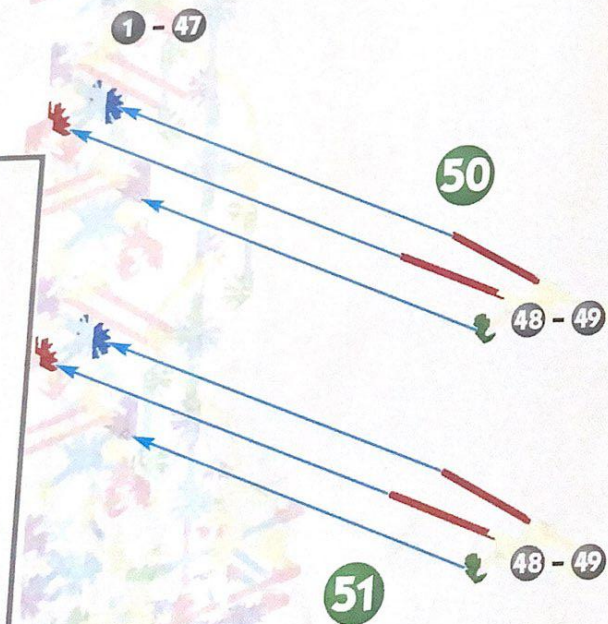
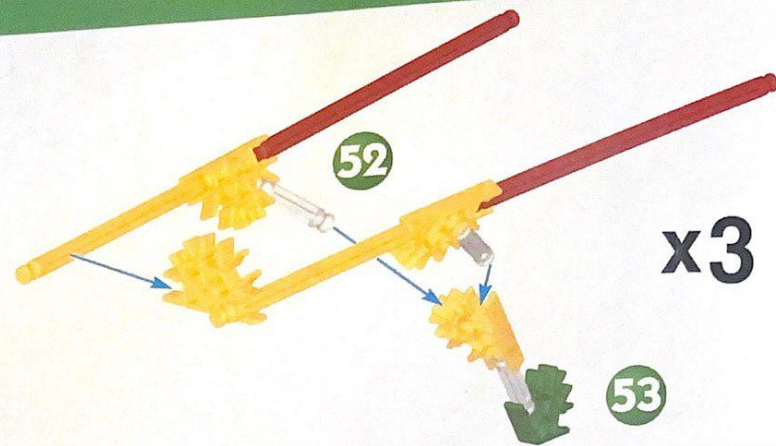
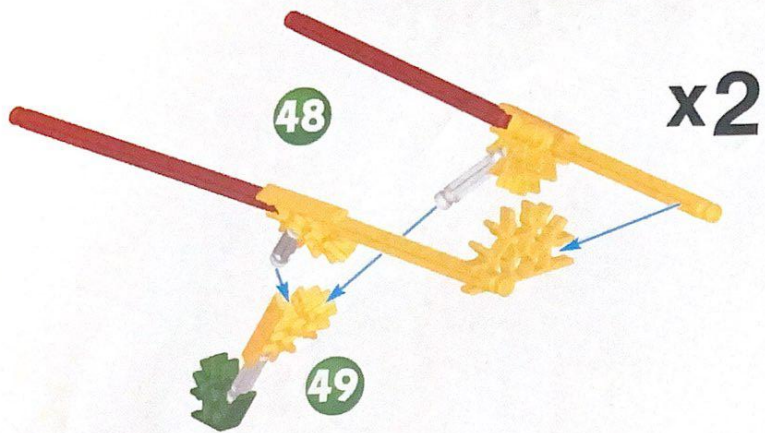

Stepper

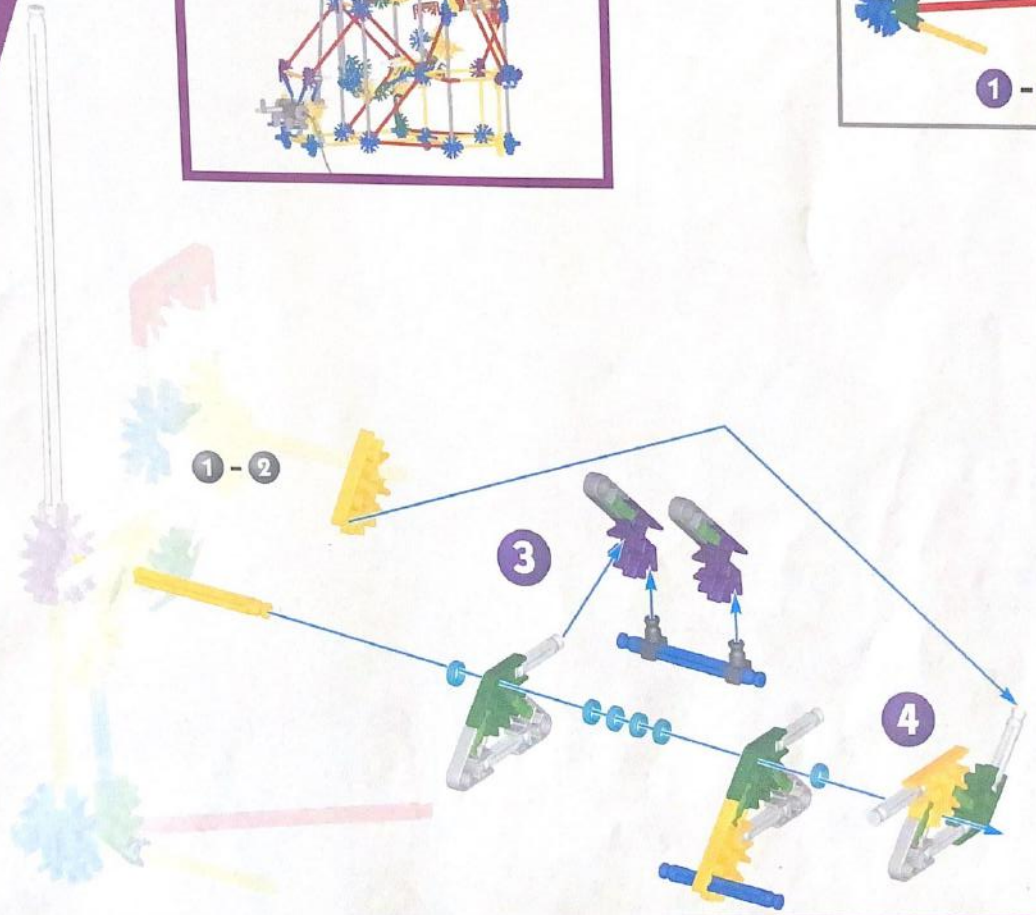
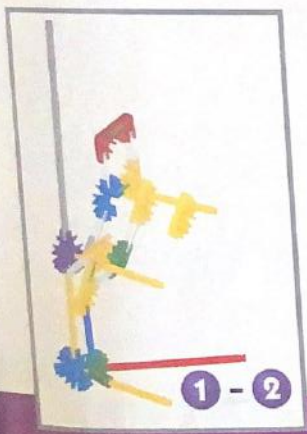
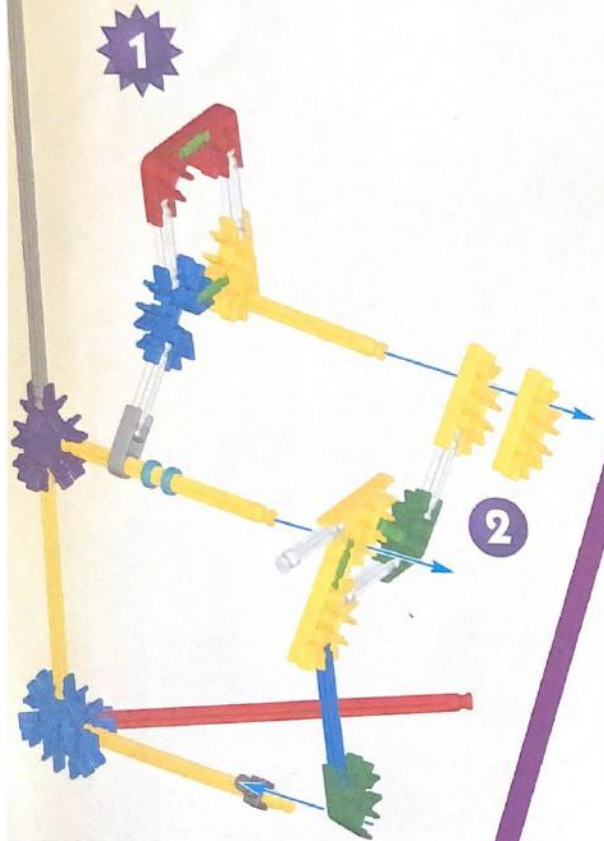
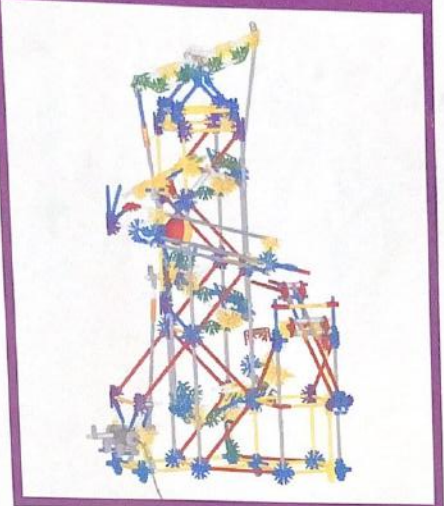

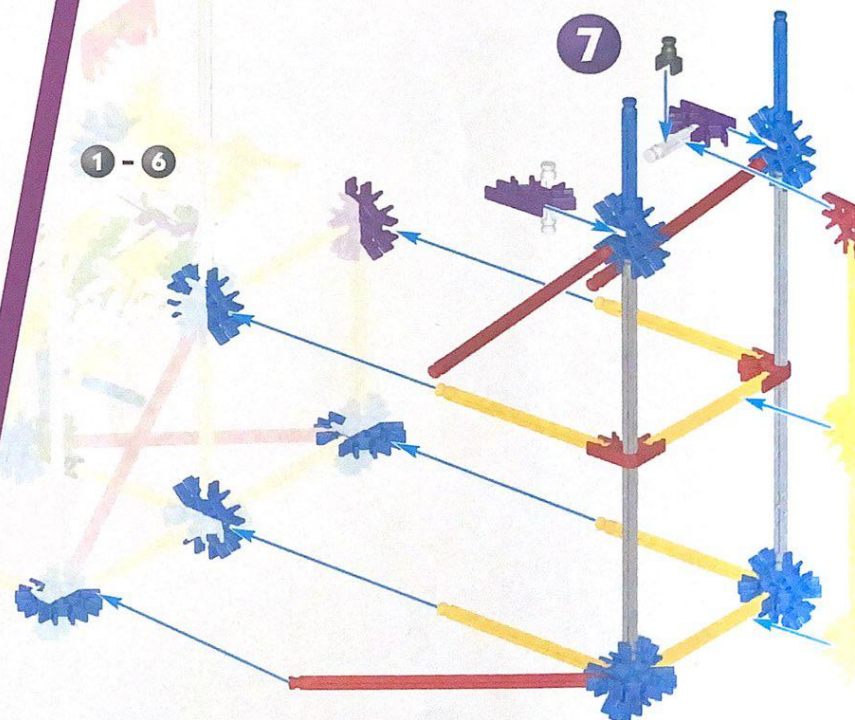
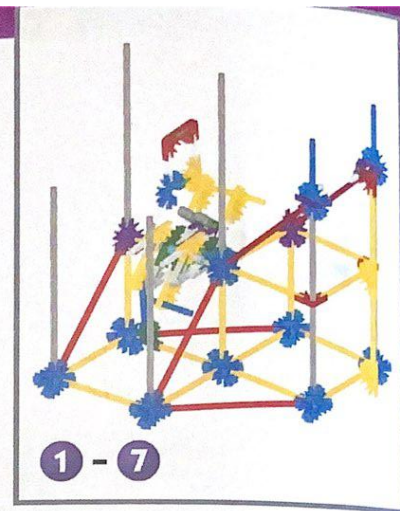
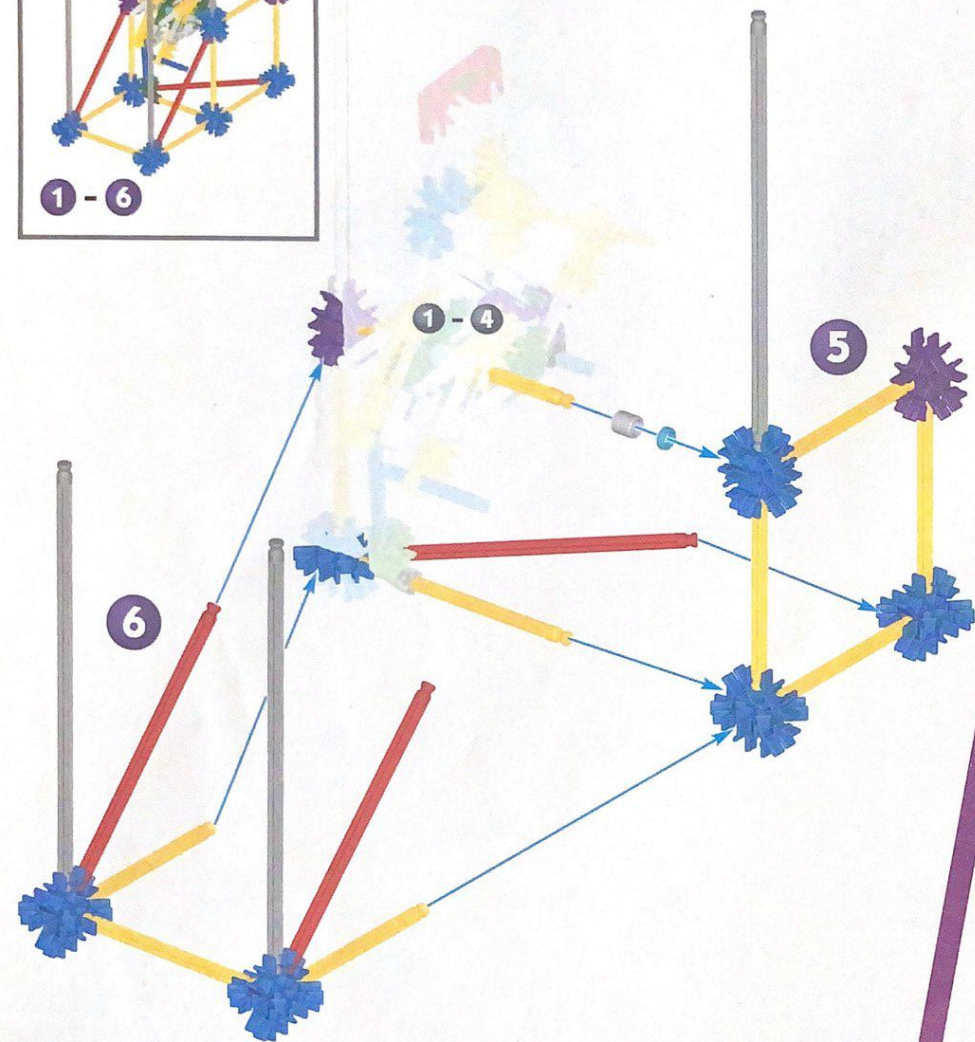
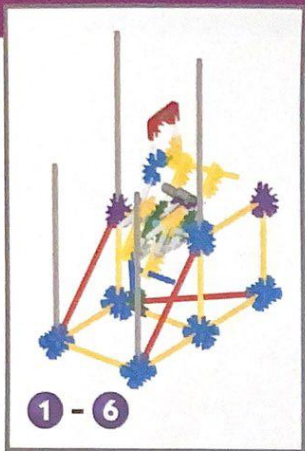

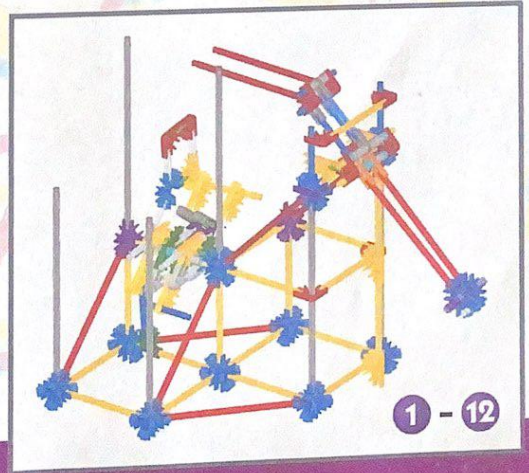
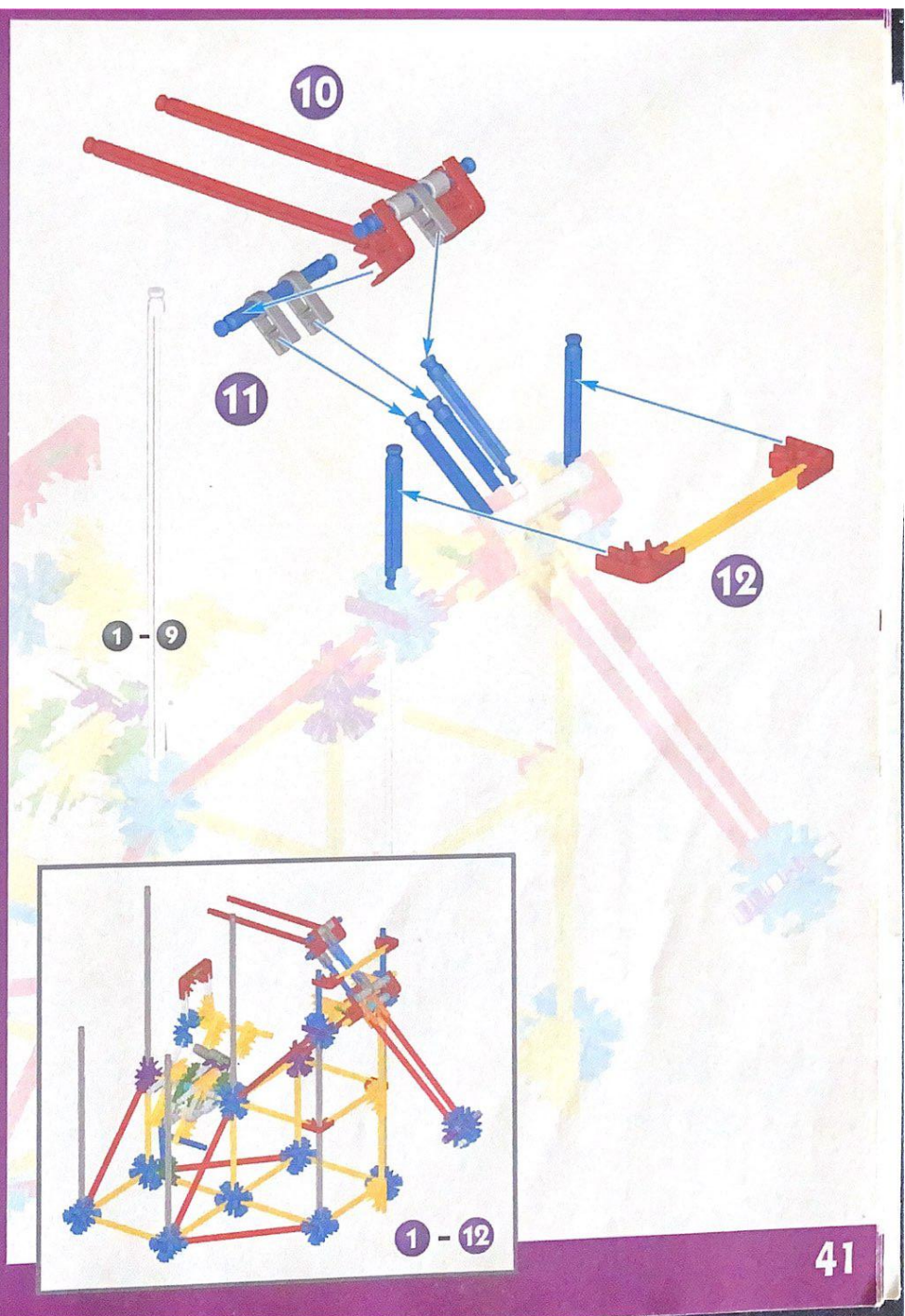
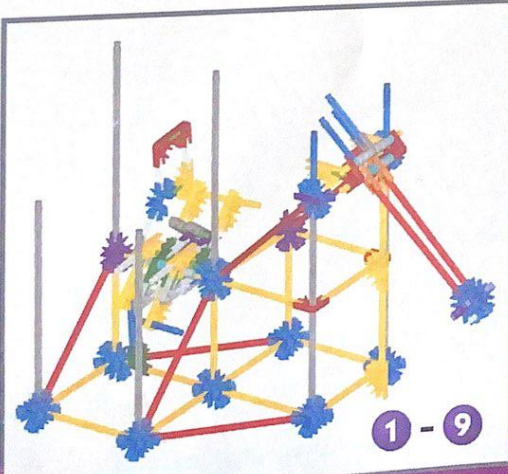
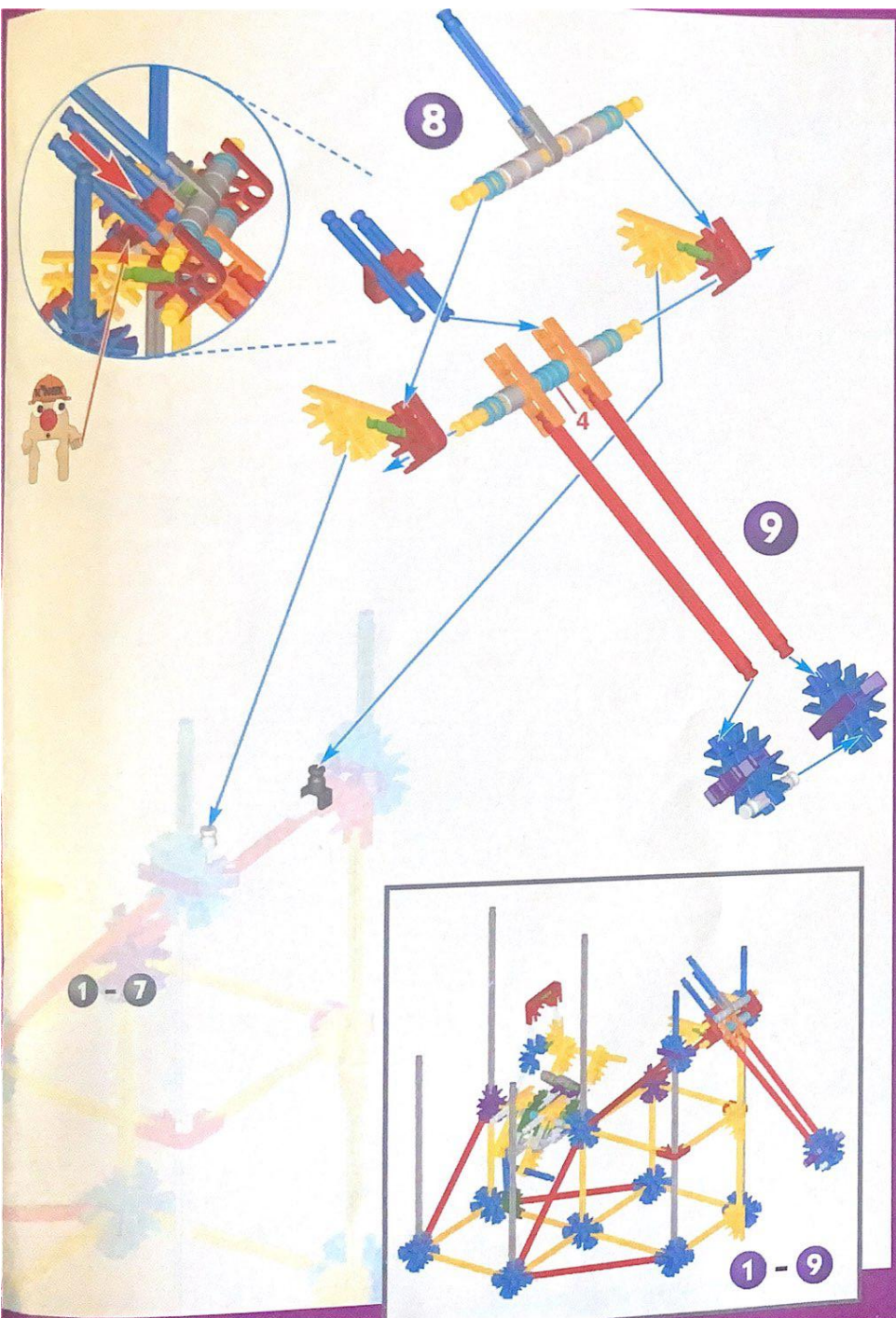

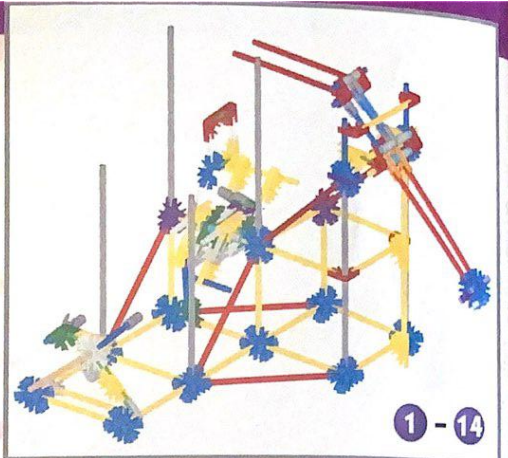

1 - 12

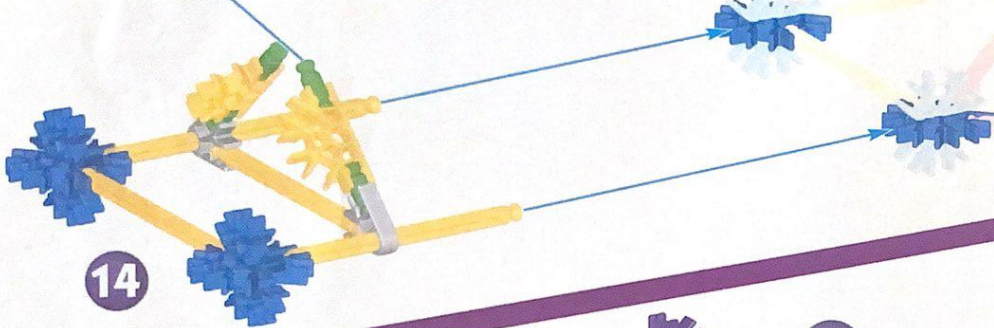
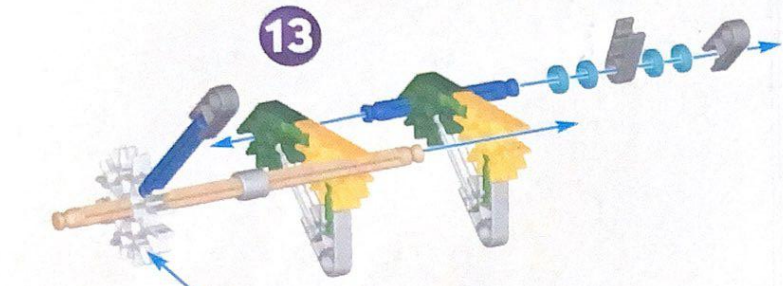

1 - 14

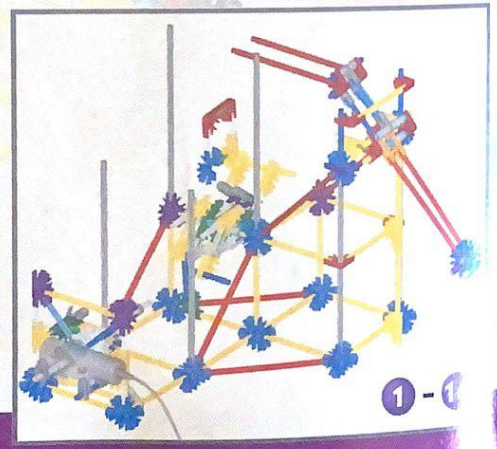

15

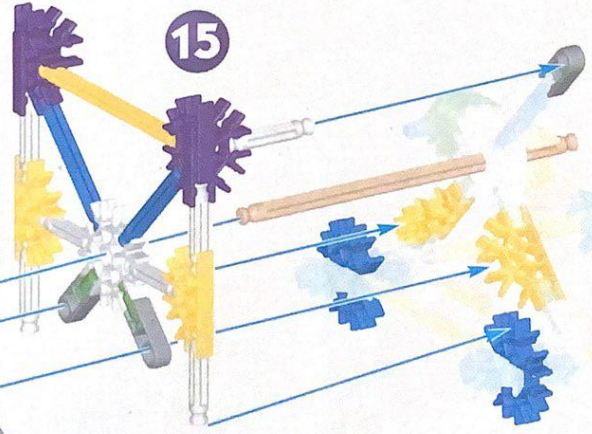

16

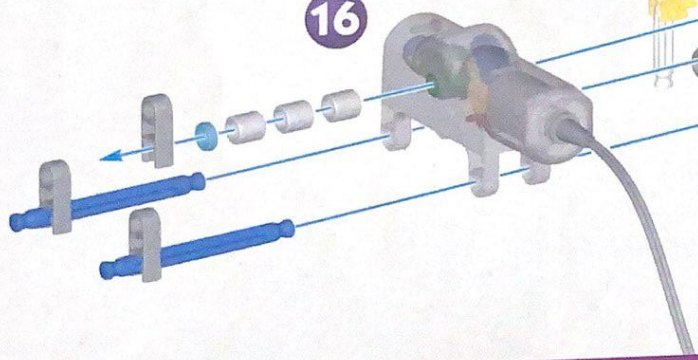

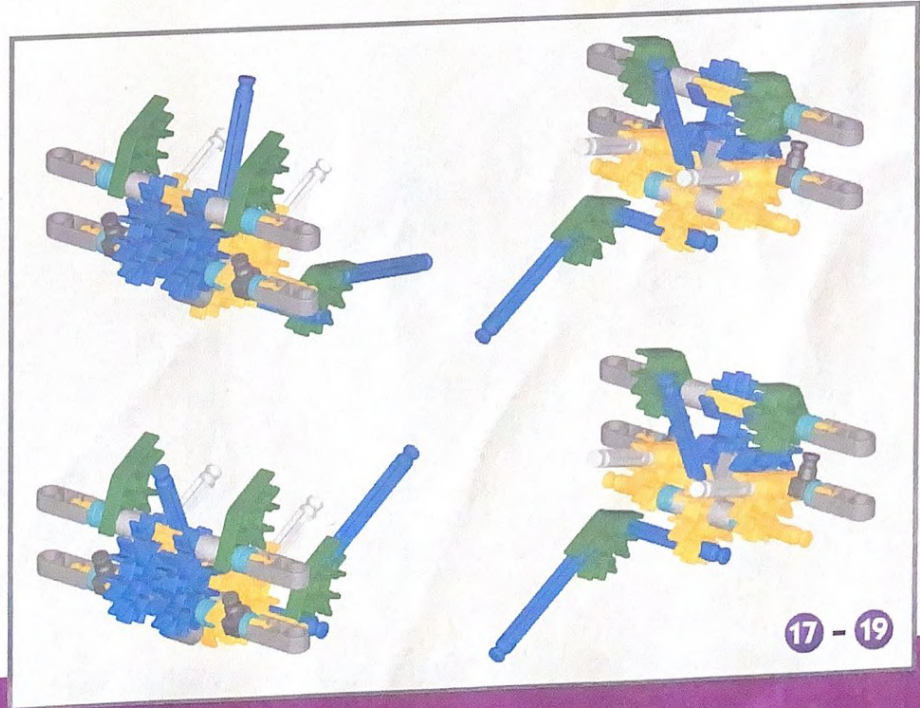
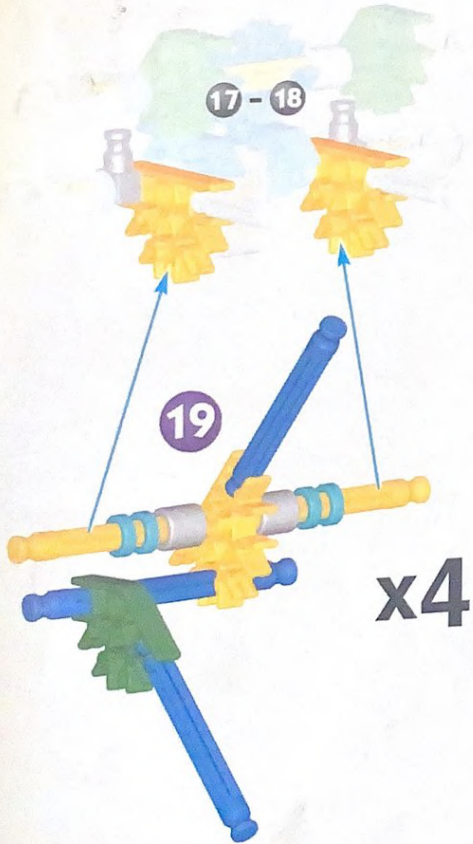
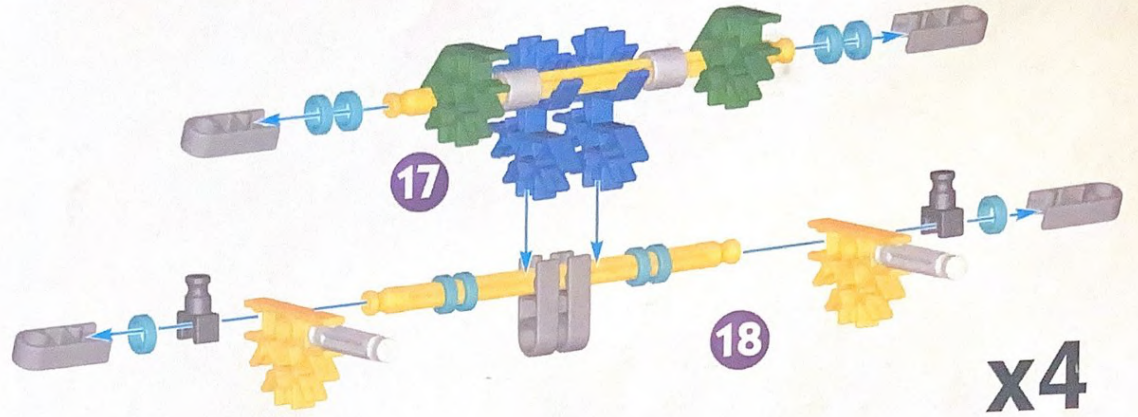

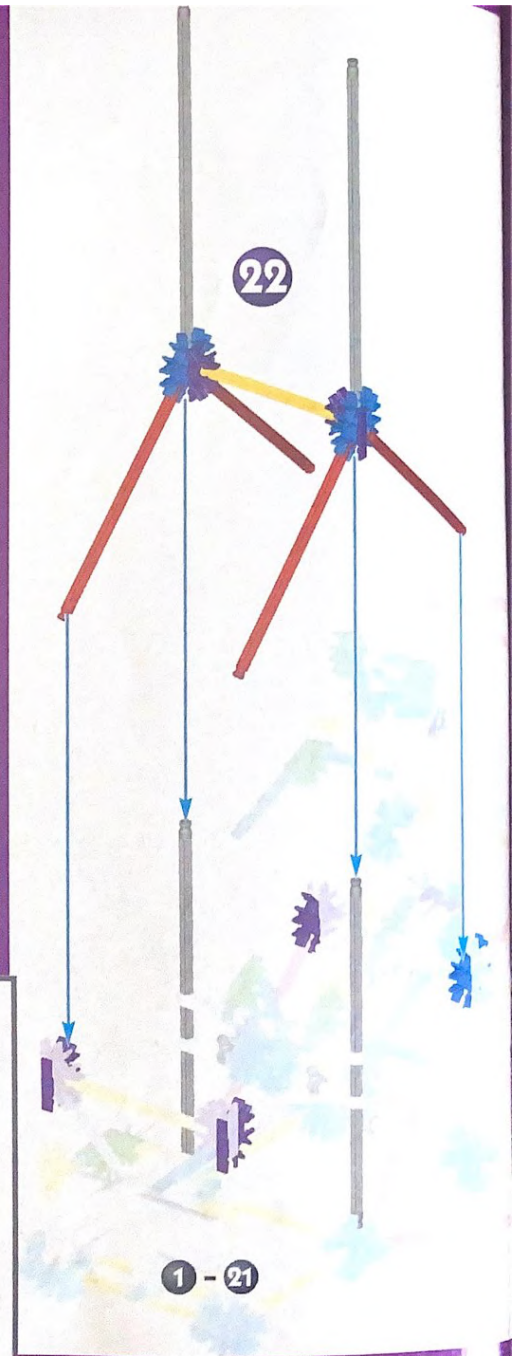
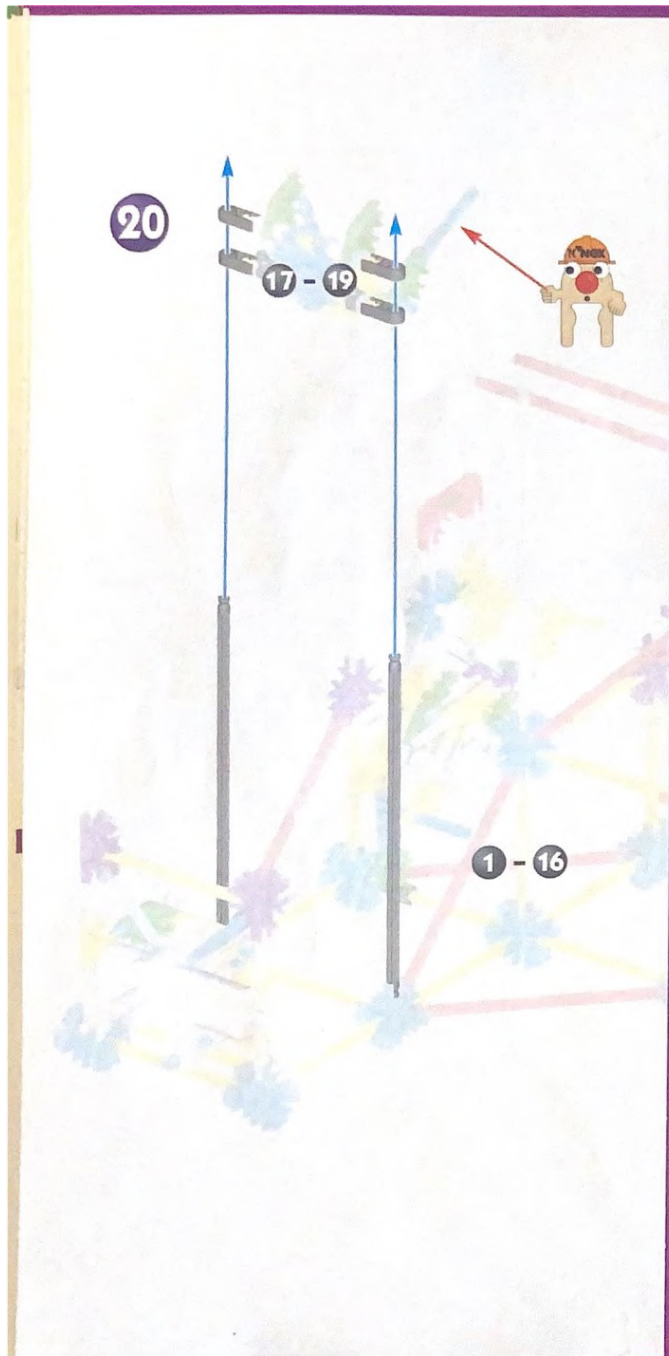

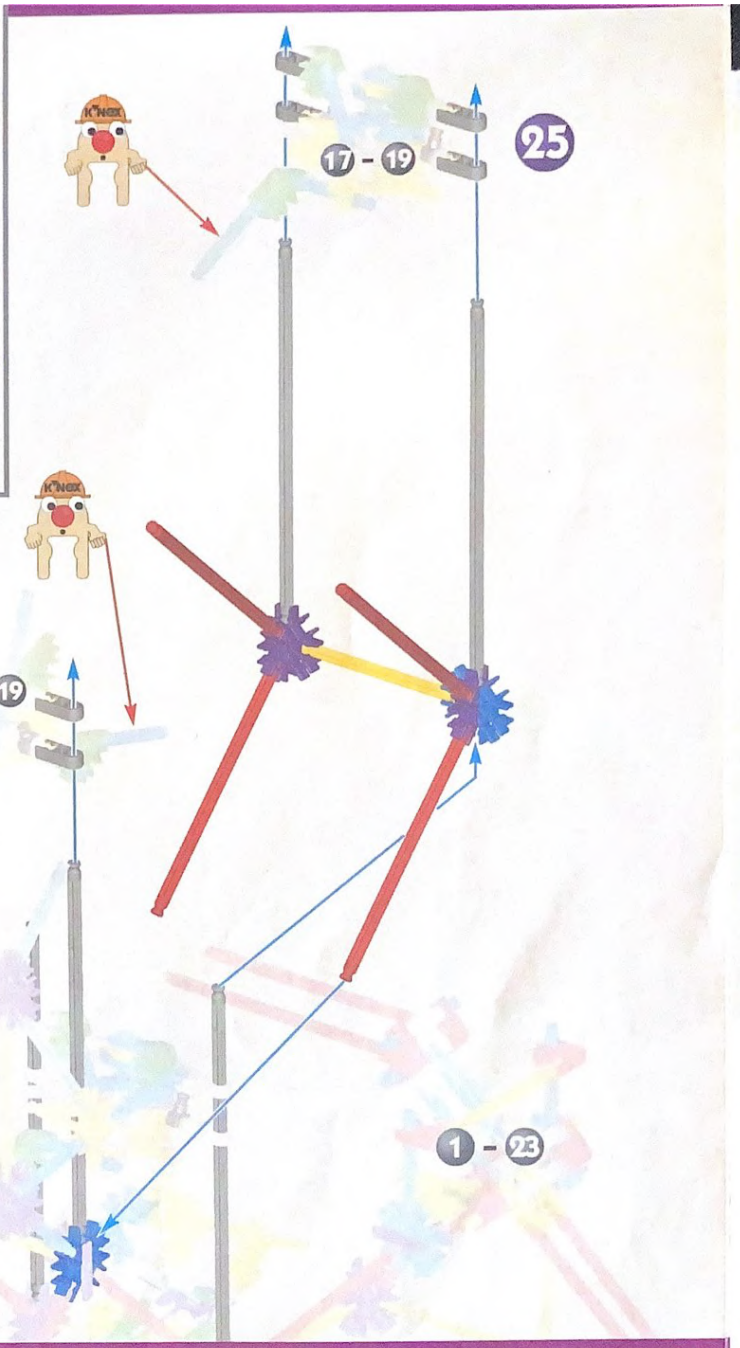
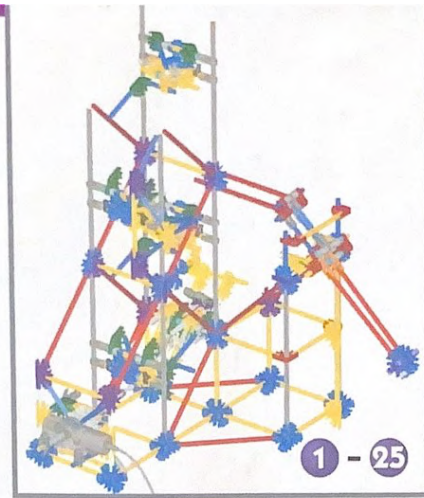
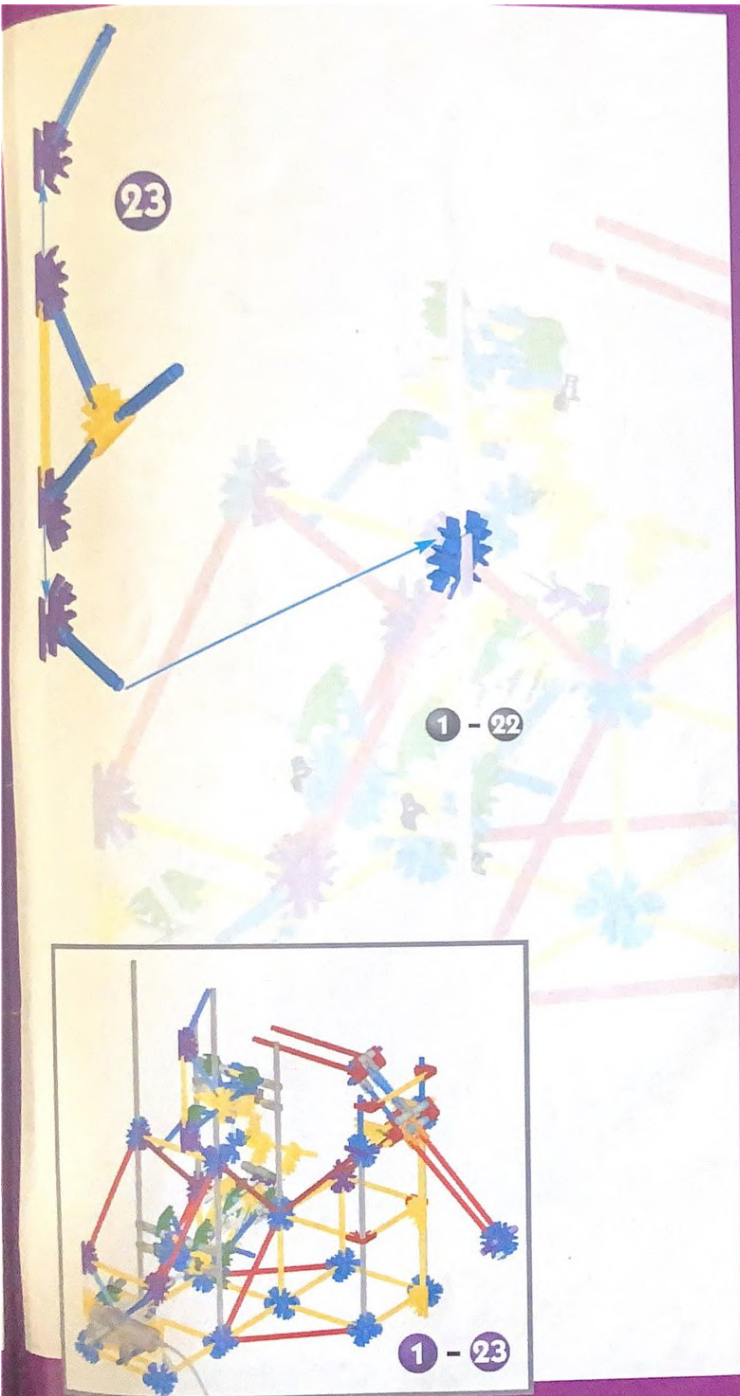

26

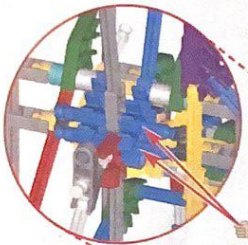

27

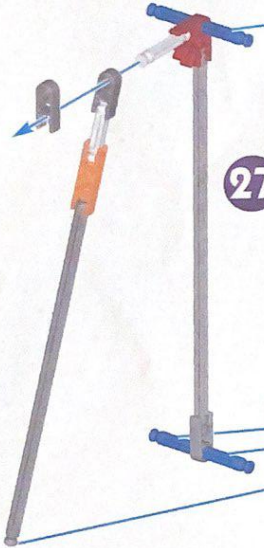

1 - 25

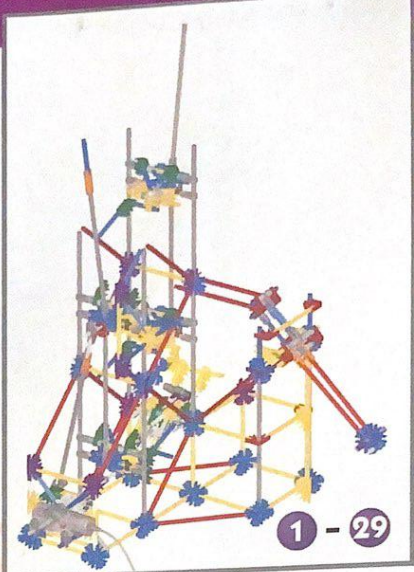
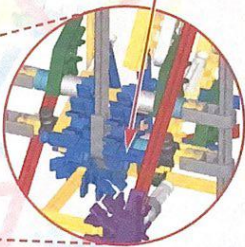

1 - 29

29

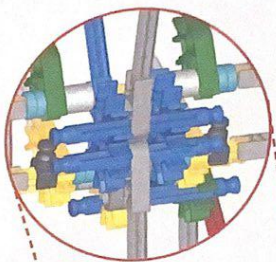

1 - 27

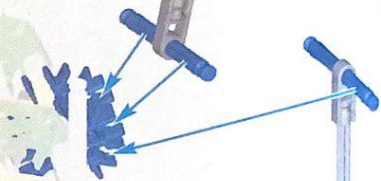

28

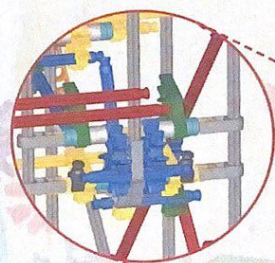

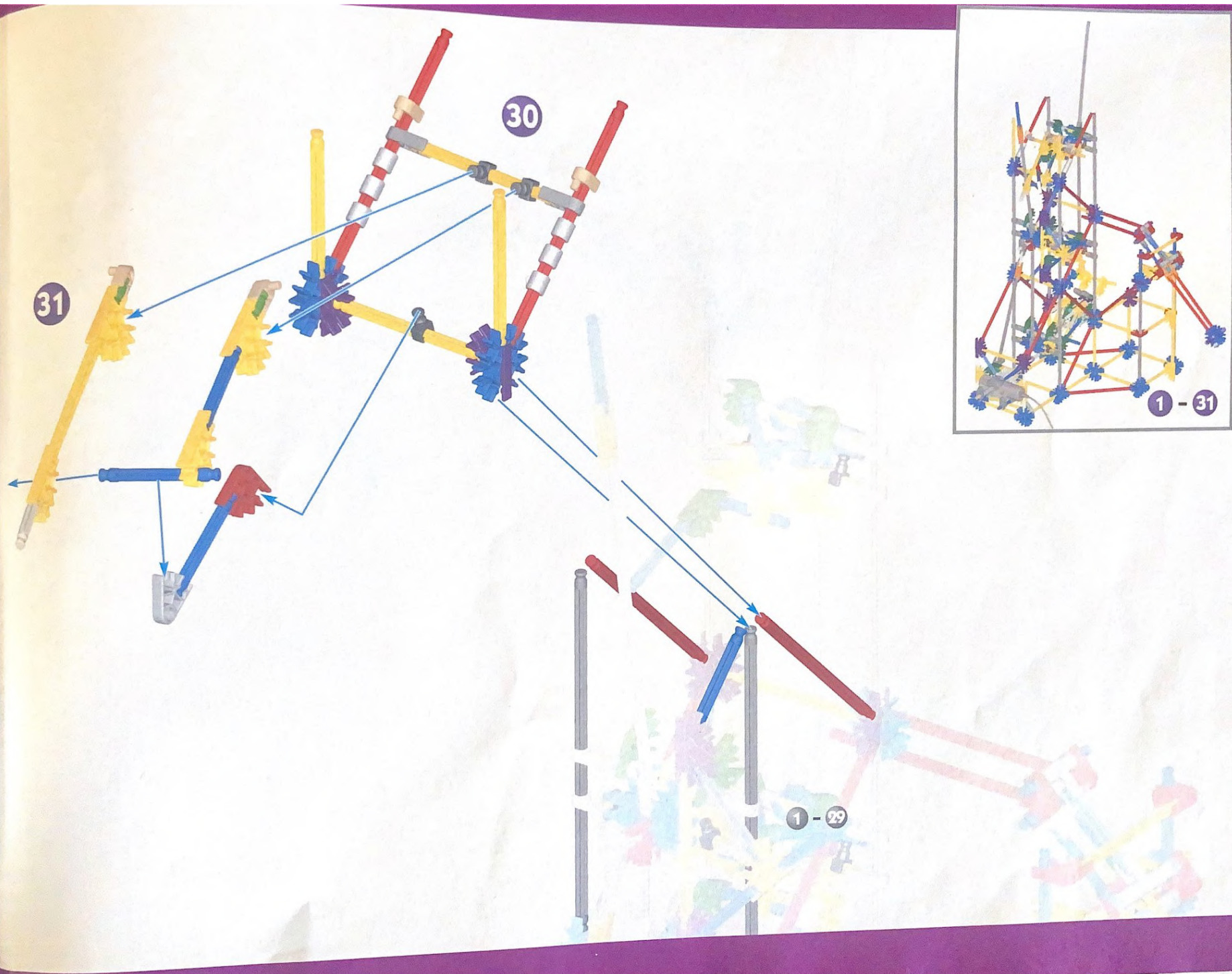

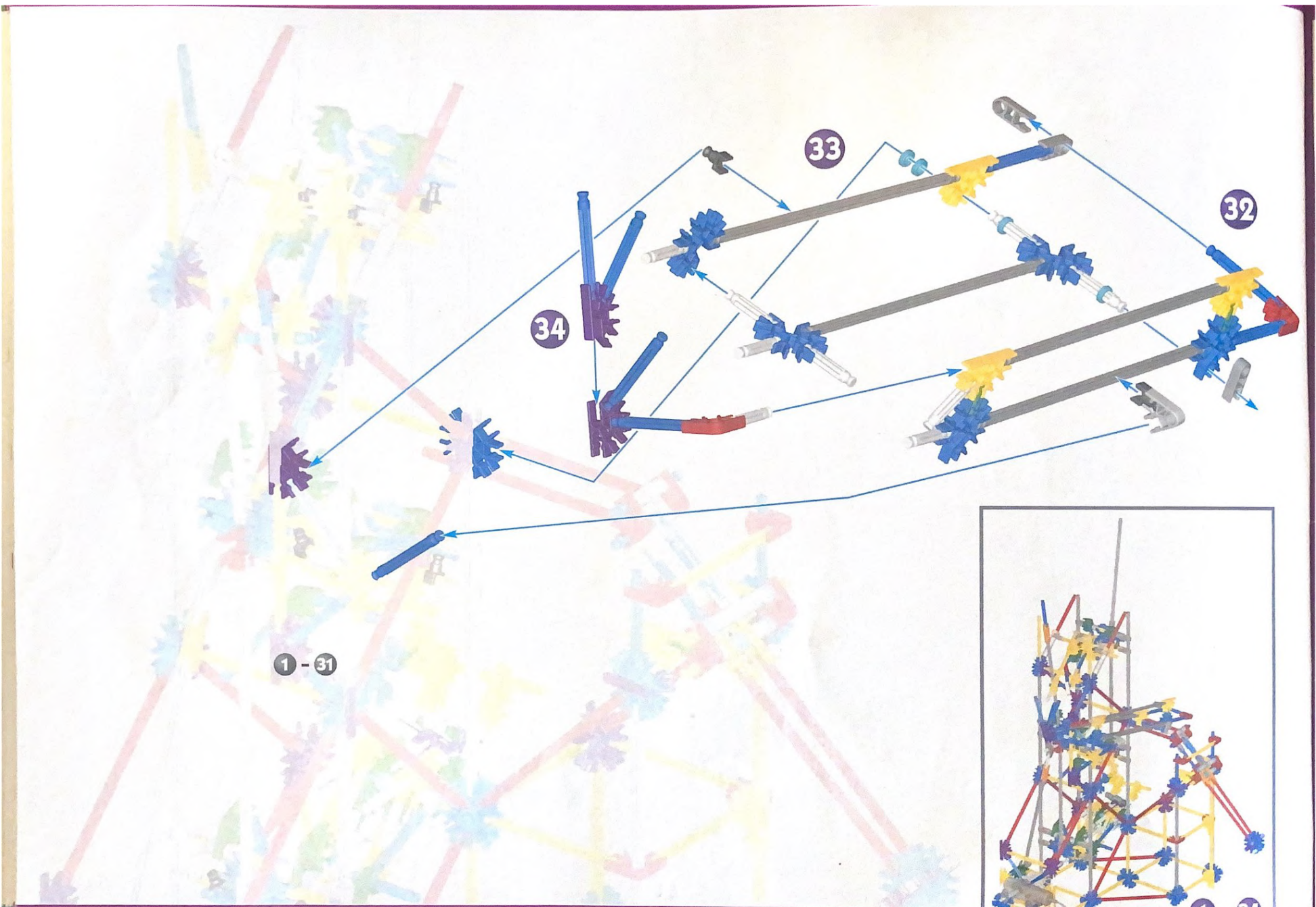

1 - 31

