

ULTRABOTS

14127/24127



K'NEX

Creative Construction for Kids™

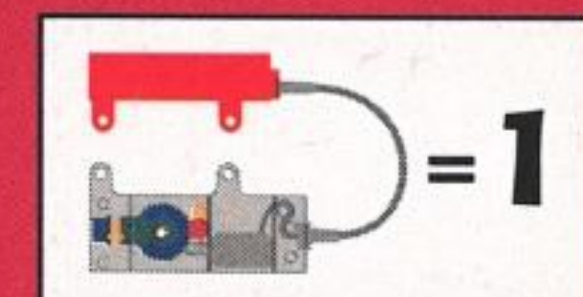

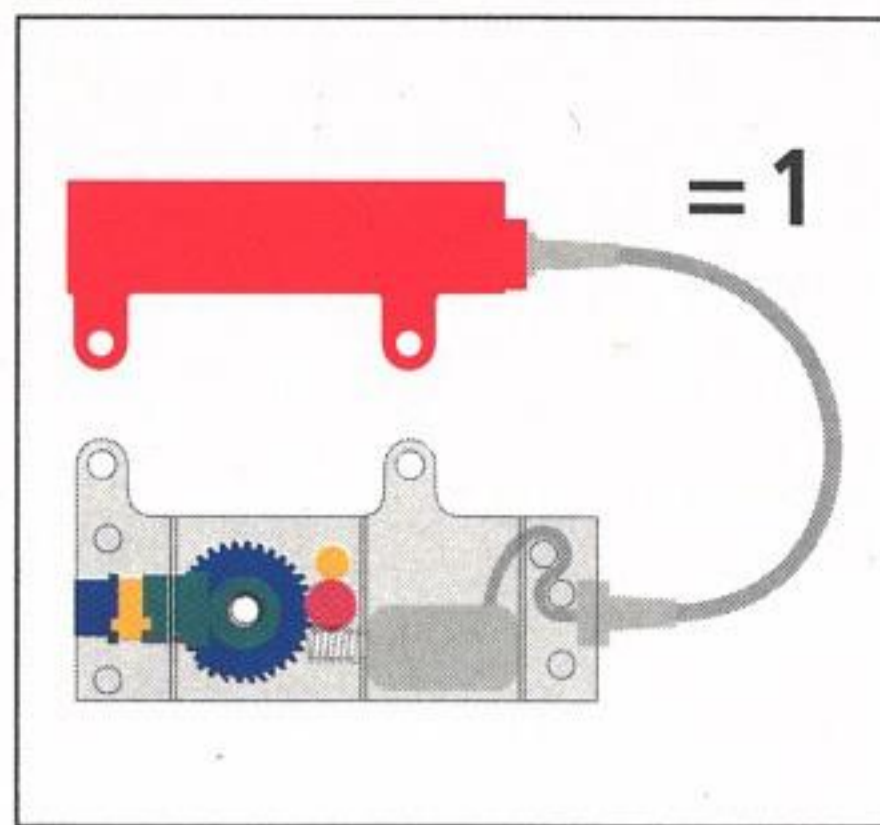

- USA (GB)** Set contains one (1) Battery PowerPack™. (Batteries not included.) *Install batteries before building models.*
- F** Ce jeu contient un (1) bloc d'alimentation sur piles PowerPack™. (Se procurer les piles séparément.) *Mettre les piles en place avant de construire les modèles.*
- I** Il set contiene un (1) PowerPack™ a batteria. (Batteria non inclusa nella confezione.) *Installare la batteria prima di costruire i modelli.*
- D** Satz enthält ein (1) batteriebetriebenes PowerPack™. (Batterien nicht eingeschlossen.) *Vor dem Bau der Modelle die Batterien installieren.*
- E** El juego contiene un (1) baterías PowerPack™. (Las baterías no están incluidas.) *Coloca las baterías antes de armar los modelos.*

- S** Satsen innehåller ett (1) Battery PowerPack™. (Batterier medföljer ej.) *Installera batterierna innan du bygger modellerna.*
- DK** Sættet indeholder én (1) Battery PowerPack™. (Batterier er ikke inkluderet.) *Batterierne skal installeres inden modellerne bygges.*
- N** Dette settet består av én (1) Battery PowerPack™. (Batterier er ikke inkludert.) *Batteriene må installeres før modellene bygges.*
- SF** Sarja sisältää yhden (1) PowerPack™. (Paristot eivät seuraa mukana.) *Asenna paristot ennen kuin rakennat malleja.*
- NL** Set bevat één (1) Batterij-PowerPack™. (Batterijen niet inbegrepen.) *Installeer de batterijen voordat je de modellen gaat bouwen.*
- P** O conjunto contém um (1) Battery PowerPack™ de pilhas. (Pilhas não incluídas.) *Instale as pilhas antes de montar o modelo.*
- G** Το σετ περιέχει ένα (1) Battery PowerPack™. (Οι μπαταρίες δεν περιλαμβάνονται.) *Τοποθετήστε τις μπαταρίες πριν κατασκευάσετε τα μοντέλα.*
- TR** Sette bir (1) PowerPack™ Pili vardır. (Piller dahil değildir.) *Pilleri modelleri monte etmeden takın.*
- J** הערכה כוללת סוללת PowerPack™ אחת (1). (הסוללות אינן נכללות בערכה.) *התקן את הסוללות לפני הרכבת הדגמים.*
- CHI** セットには、Battery PowerPack™ が1つ含まれています (電池は含まれていません)。モデルを組み立てる前に、電池を取り付けてください。
- IL** 每套含 (1) 個 Battery PowerPack™ (不含電池)。請先安裝電池，再行拼裝。

Service Information in the USA and Canada

If your K'NEX PowerPack™ does not work, try new batteries. If it still does not work, call us at: **1-800-KID-KNEX** (Monday thru Friday, 8:30 AM – 5:00 PM Eastern Standard Time). Please do not return the K'NEX PowerPack to the store or catalog house where it was purchased; they will not be able to help you.

- USA (GB)** Contains small parts. Not suitable for children under the age of 3 years.
- F** Contient des pièces de petite taille. Ne convient pas aux enfants de moins de 3 ans.
- I** A causa dei suoi piccoli componenti, questo giocattolo non è adatto a bambini di età inferiore ai 3 anni.
- D** Enthält kleine Teile und ist daher nicht für Kinder unter 3 Jahren geeignet.
- E** Debido a la presencia de piezas pequeñas, no se recomienda su uso para menores de 3 años.
- S** Innehåller smådelar. Ej lämpligt för barn under 3 år.
- DK** Ikke egnet for børn under 3 år pga. smådele.
- N** Inneholder smådelar. Egner seg ikke for barn under 3 år.
- SF** Varoitusta! Ei soveltu alle 3-vuotiaalle lapsille. Sisältää pieniä osia.

- NL** Bevat kleine onderdelen. Niet geschikt voor kinderen jonger dan 3 jaar.
- P** Devido às dimensões reduzidas de algumas peças, não é recomendado para crianças de idade inferior a 3 anos.
- G** Λόγω των μικρών εξαρτημάτων που περιέχουν, δεν είναι κατάλληλα για παιδιά μικρότερα των 3 ετών.
- TR** Küçük parçalardan dolayı 3 yaşından küçük çocuklar için uygun değildir.
- J** 細かい部品がありますので、3才以下のお子様には適しません。
- CHI** 內含極小零件，不適合3歲以下孩童。
- IL** מאחר והערכה מכילה חלקים קטנים, היא אינה מתאימה לילדים מתחת לגיל 3.

WARNING:
CHOKING HAZARD – Small Parts.
Not for Children under 3 years.



AVERTISSEMENT!
Danger d'étouffement. Pièces de petite taille.
Ne pas donner aux enfants de moins de 3 ans.

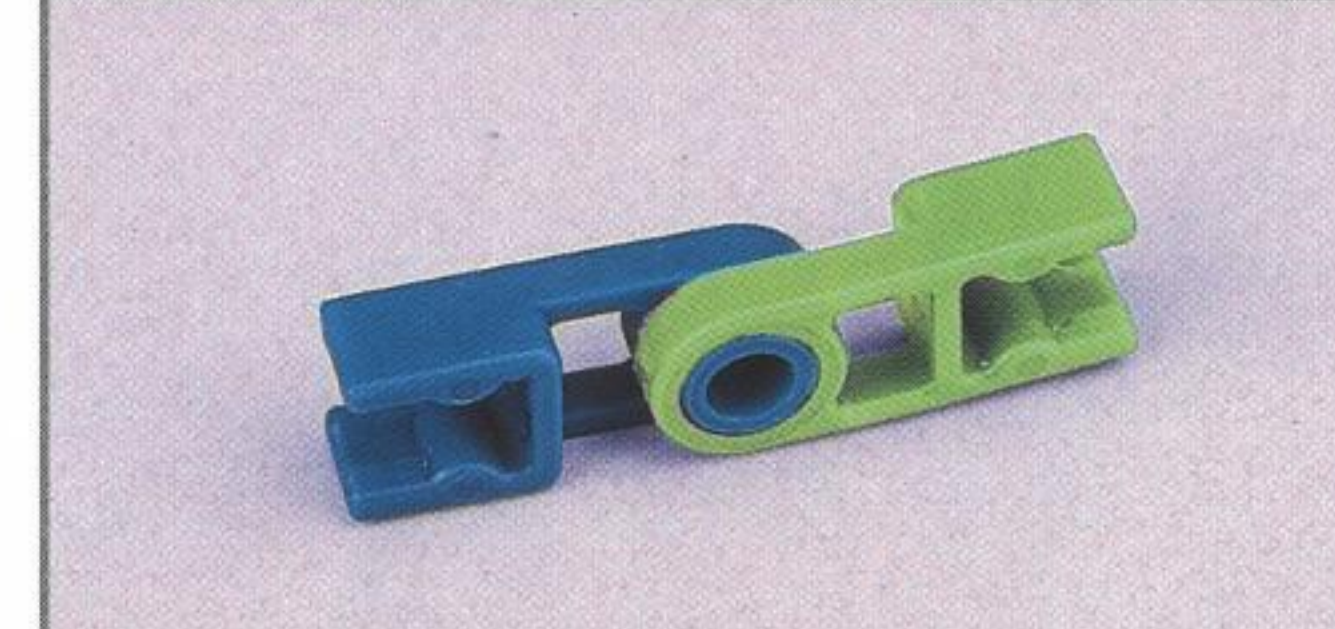
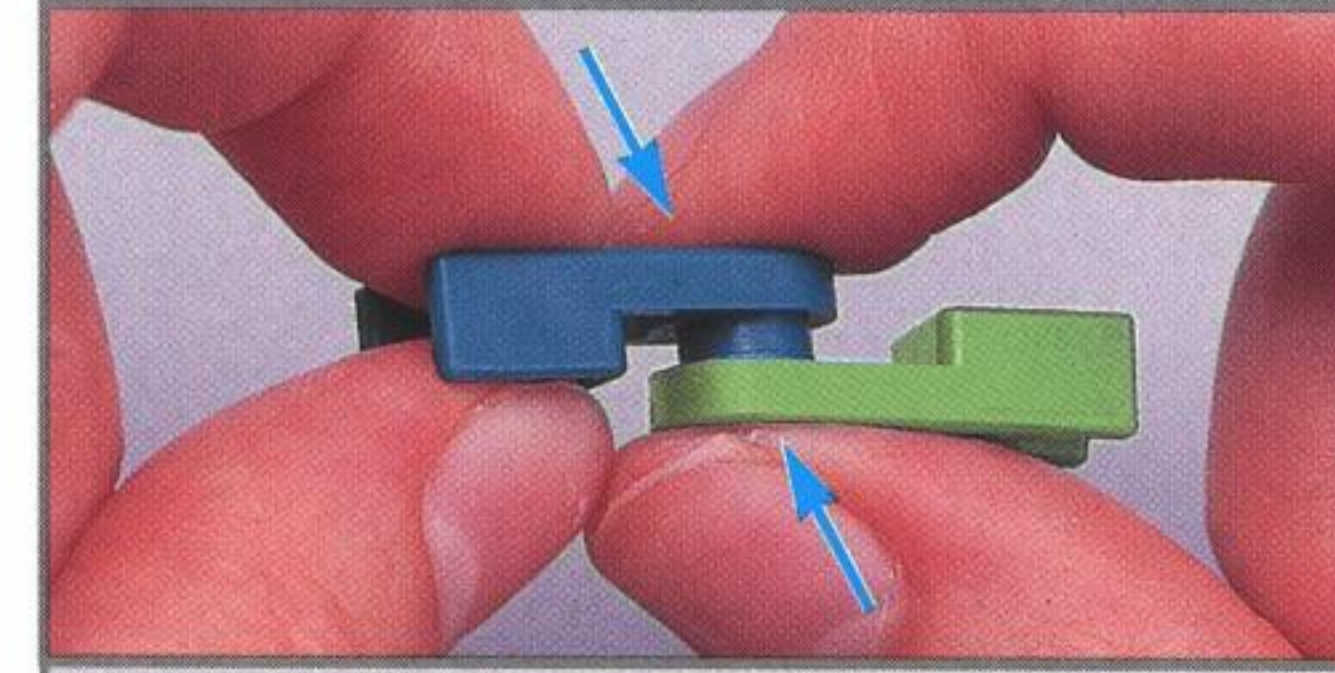
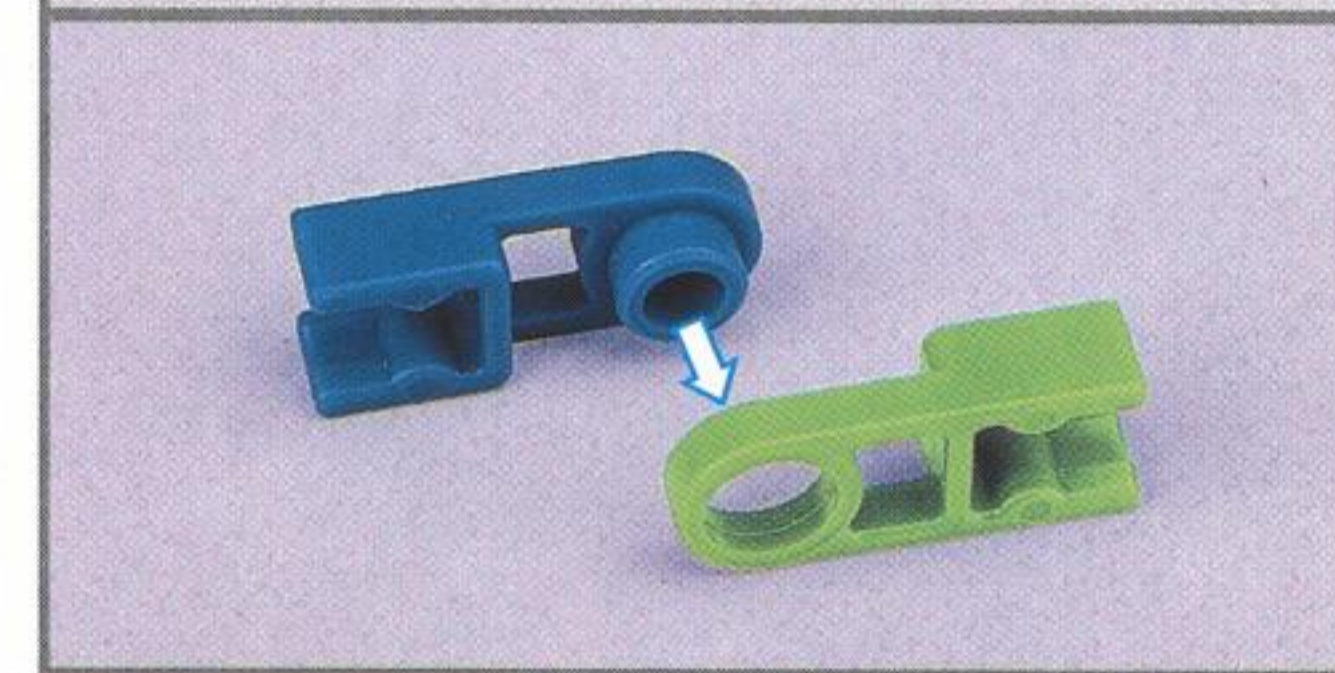
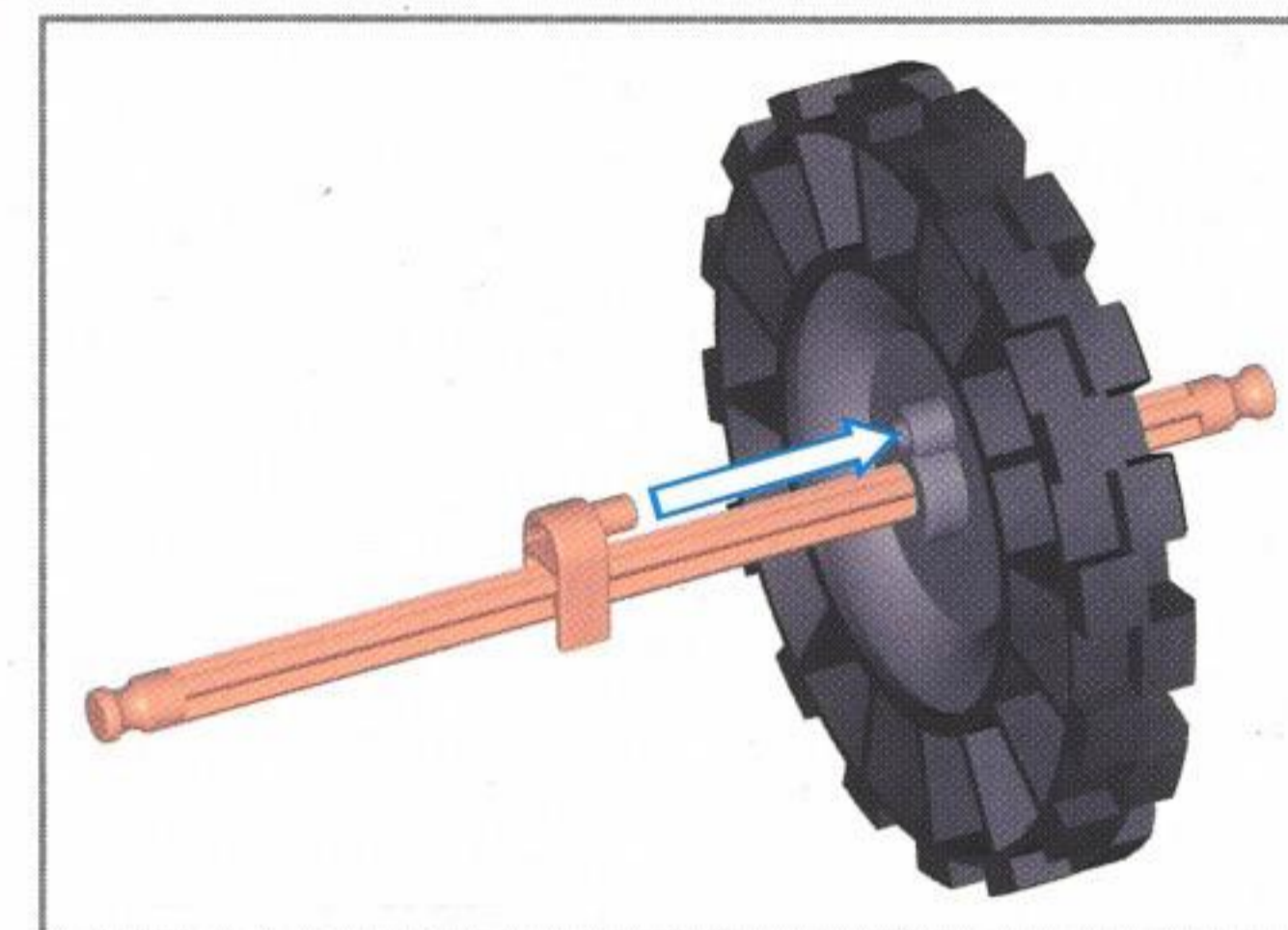
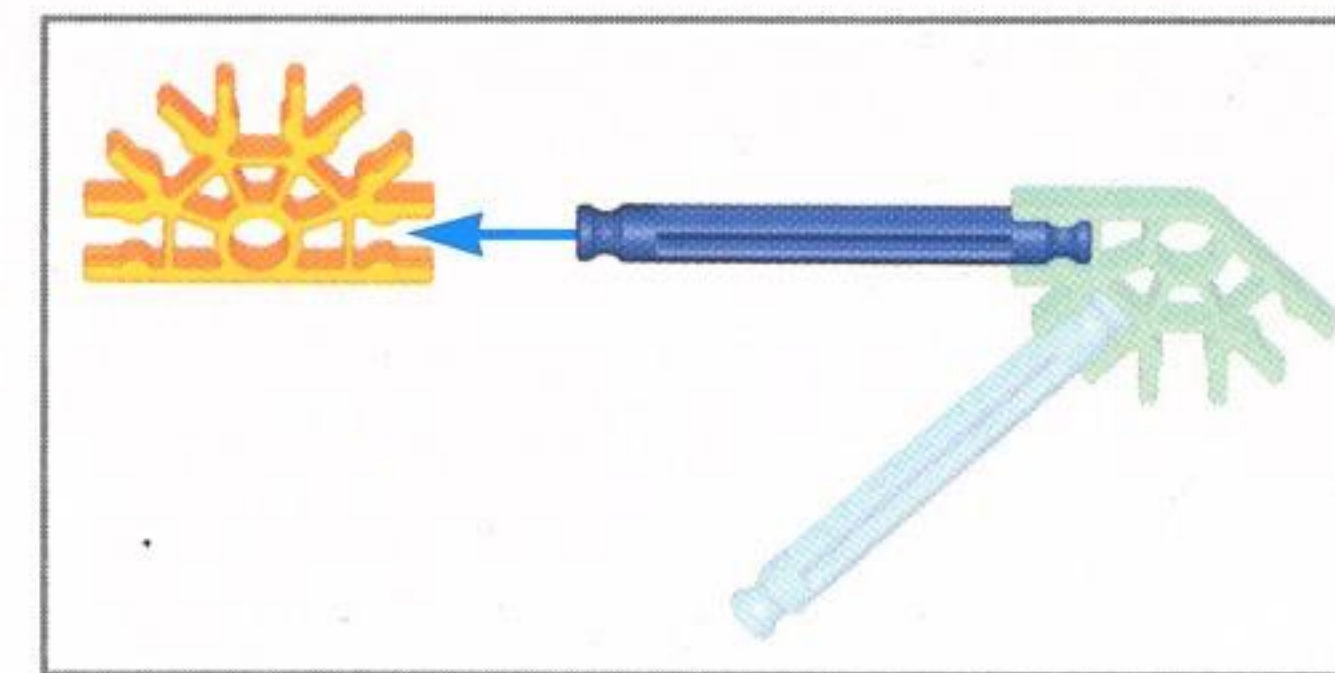

USA (GB) Each K'NEX piece has its own special color (colour) and shape; match it to pieces in the picture instructions. Put pieces together exactly as pictures show. Faded colors (colours) indicate sections previously built; points of attachment will be in full color (colour).

Colors (colours) of gears in Battery PowerPack may vary from colors (colours) shown.

Do not put small green rods in any openings of the Battery PowerPack; they will damage the motor, and cannot be removed.

F Chaque élément K'NEX a une forme et une couleur qui lui sont propres. Faites correspondre et montez les éléments en vous conformant exactement aux instructions illustrées. Les couleurs plus claires correspondent aux sections déjà construites et les points de jonction sont indiqués en couleurs vives.

La couleur des roues dentées du bloc d'alimentation sur piles PowerPack peut ne pas correspondre exactement à la couleur des illustrations.

Ne placez aucune petite tige verte dans les ouvertures du bloc d'alimentation sur piles PowerPack où elles risquent de se bloquer et d'endommager le moteur.

I Ciascun pezzo di K'NEX ha un colore ed una forma diversi; far corrispondere ciascun pezzo al corrispettivo nelle istruzioni figurate. Montare i pezzi esattamente con riportato nelle figure. I colori schiariti indicano le sezioni già assemblate; i punti di collegamento sono illustrati a colori vivi.

I colori degli ingranaggi del PowerPack a batteria possono essere diversi da quelli riportati in figura.

Non inserire le astine verdi nelle aperture del PowerPack; ciò danneggia il motore e le astine rimarranno incastrate.

D Jedes K'NEX-Stück hat seine eigene besondere Farbe und Form; finden Sie die entsprechenden Stücke in der illustrierten Anleitung. Setzen Sie die Stücke genau wie auf dem Bild dargestellt zusammen. Die farblich heller gekennzeichneten Teile zeigen bereits zusammengebaute Abschnitte an; die Anbringungspunkte sind in kräftigen Farben angegeben.

Die Farben der Zahnräder im batteriebetriebenen PowerPack können von den

abgebildeten Farben abweichen.

Keine kleinen grünen Stangen in die Öffnungen des batteriebetriebenen PowerPack einsetzen; sie beschädigen den Motor und können nicht entfernt werden.

E Cada pieza K'NEX tiene su propio color y forma particular; combínala con las piezas en las instrucciones ilustradas. Arma las piezas exactamente como se muestra en las ilustraciones. Los colores pálidos indican las secciones que ya se armaron y los puntos de conexión figurarán a todo color.

Los colores del engranaje en el PowerPack de baterías podrían ser diferentes de los colores indicados.

No coloques las varillas verdes pequeñas en ninguna abertura del PowerPack de baterías ya que no las podrás sacar y podrían dañar el motor.

S Varje bit i K'NEX har sin egen färg och sin egen form; matcha den med bitarna i illustrationen till instruktionerna. Sätt ihop bitarna precis som bilden visar. Mattare färger anger sektioner som redan har byggts; monteringspunkterna kommer att vara i full färg.

Färgerna på kugghjulen i Battery PowerPack kan vara annorlunda än de färger som visas.

Sätt inte in de små gröna stängerna i någon öppning i Battery PowerPack; de skadar motorn och kan inte avlägsnas.

N Hver K'NEX del har sin egen, spesielle farge og form, som skal koordineres med delene i bruksanvisningene med bilder. Delene må settes sammen akkurat slik som bildene viser. Bleke farger henviser til seksjoner som har blitt bygget tidligere; festpunktene vil bli fremvist i sterke farger.

Fargene på girene i Battery PowerPack kan eventuelt være annerledes enn de fargene som vises.

De små røde stengene må ikke stikkes inn i noen av åpningene på Battery PowerPack, da dette kan medføre skade på motoren, og de kan ikke fjernes.

DK Hvert K'NEX stykke har sin egen særlige farve og facon. Afpas stykket med vejledningen på billedet. Sæt stykkerne sammen nøjagtigt som billederne viser. Nedtonede farver indikerer afsnit, som allerede er sat sammen; samlingspunktet vises i fuld farve.

Farverne på gear i Battery PowerPack kan afvige fra de viste farver.

De små grønne stænger må ikke stikkes i nogen af åbningerne på Battery PowerPack. De kan ødelægge motoren og kan ikke tages ud.

SF Jokaisella K'NEX-osalla on oma värinsä ja muotonsa; sovita se kuvan ohjeiden mukaan. Pane palaset yhteen kuvien osoittamalla tavalla. Haalistuneet värit osoittavat aikaisemmin rakennettuja osia; liitäntäkohdat ovat täysvärisiä.

PowerPack hammaspyörrien värit voivat erota näytetyistä väreistä.

Älä pane pieniä vihreitä sauvoja mihinkään PowerPack reikään; ne vahingoittavat moottoria eikä niitä voi poistaa.

NL Elk K'NEX onderdeel heeft zijn eigen speciale kleur en vorm; vergelijk ze met de onderdelen in de instructie-afbeeldingen. Zet de onderdelen precies volgens de afbeeldingen in elkaar. De vaal gekleurde gedeelten zijn al eerder gebouwd; de bevestigingspunten zijn in volle kleur weergegeven.

De kleuren van de tandwielen in het PowerPack kunnen verschillen van de kleuren in de afbeeldingen.

Plaats geen groene staafjes in openingen van het PowerPack; zij zullen de motor beschadigen en kunnen niet worden verwijderd.

P Cada uma das peças K'NEX possui uma cor e forma próprias; compare-as com as peças apresentadas nas instruções. Monte as peças exatamente como indicado nas fotografias. As cores mais esbatidas identificam as seções já construídas; os pontos de encaixe aparecem em cores vivas.

As cores das engrenagens no Battery PowerPack poderão diferir das apresentadas.

Não introduza as pequenas hastas de cor verde nos orifícios do Battery PowerPack; estas danificarão o motor e não poderão ser removidas.

G Κάθε κομμάτι έχει το δικό του ξεχωριστό χρώμα και σχήμα για να το ταυριάζετε με τα κομμάτια που βλέπετε στις οδηγίες. Συνδέστε τα κομμάτια όπως ακριβώς δείχνουν οι οδηγίες. Τα σβησμένα χρώματα δείχνουν τα τμήματα που έχουν ήδη κατασκευαστεί. Τα σημεία σύνδεσης

φαίνονται με πιο έντονο χρώμα.

Τα χρώματα των οδοντωτών τροχών στο Battery Power Pack μπορεί να διαφέρουν από τα χρώματα που φαίνονται στο σχήμα.

Μην βάζετε τις μικρές πράσινες ράβδους στα ανοίγματα του Battery Power Pack γιατί προκαλούν ζημιά στη μηχανή και δεν βγαίνουν.

TR

Her K'NEX parçasının ayrı bir şekli ve terilenlerle eşleştirin. Parçaları aynen resimlerde gösterildiği gibi birleştirin. Soluk renkler daha önceden monte edilen kısımları gösterir; geçiş noktaları tam renkli olarak gösterilmiştir.

PowerPack Piliindeki dişli renkleri katalogta gösterilen renklerden farklı olabilir.

Küçük yeşil çubukları PowerPack Pilinin oyuklarına sokmayın; onlar motora hasar verirler ve sonra da çıkarılmaları mümkün değildir.

J K'NEXの各部品は、それぞれカラーや形状が異なります。各部品を説明図と照らし合わせて確認してください。部品は図にしたがって正しく組み合わせてください。薄いカラーで表示されている部分は、すでに組み立てられた部分です。接続する部分は、実際のカラーで示されています。

Battery PowerPackのギアは、図のカラーと異なる場合があります。

グリーンの小さいロッドはBattery PowerPackの開口に差し込まないでください。これらのロッドはモーターを破損し、取り外しができません。

CHI 每一片 K'NEX 塑膠的顏色和形狀皆不同；請依圖片指示拼裝。完成品須與圖示一模一樣。褪色處表示先前已拼好，連接處則以鮮明顏色標示。

玩具組齒輪顏色與目錄所示或有差異。
勿將小的綠桿放在玩具組的任何開口，一旦安裝便不能去除，而且還會損害馬達。

IL לכל חלק של K'NEX צבע וצורה מיוחדים משלו. התאם אותו לחלקים המופיעים בהוראות שבתמונות. חבר את החלקים בדיוק כפי שמראים בתמונות. צבעים דהויים מצביעים על חלקים שנבנו קודם לכן. נקודות החיבור מופיעות בצבע מלא.

הצבעים של גלגלי השיניים בסוללת ה-PowerPack עשויים להיות שונים מהצבעים המופיעים בתמונות.
אל תכניס מוטות ירוקים קטנים אל תוך פתחים כלשהם ב-PowerPack. מוטות אלה יגרמו נזק למנוע, ולא ניתן להוציאם.

Gold Commander

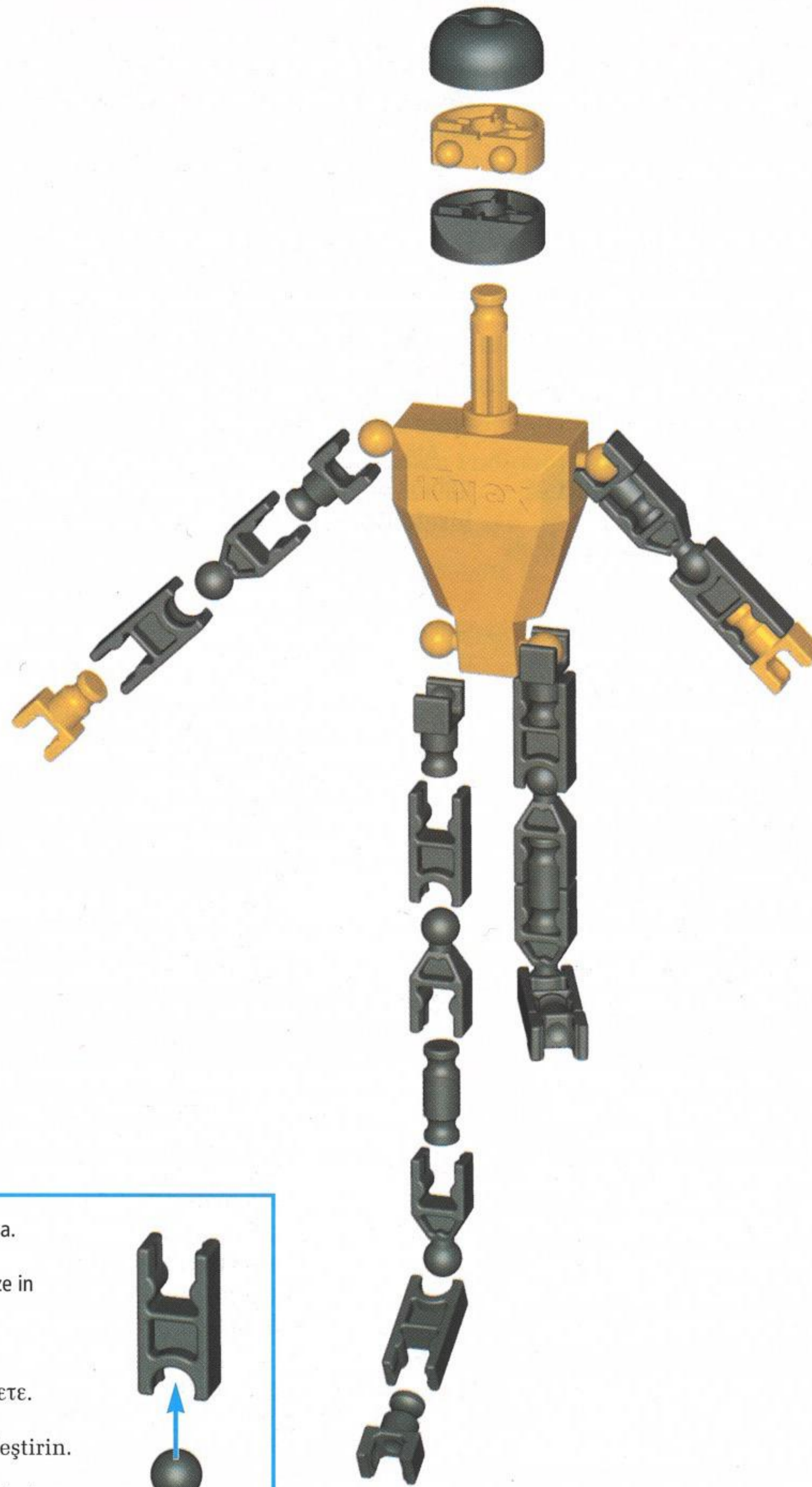
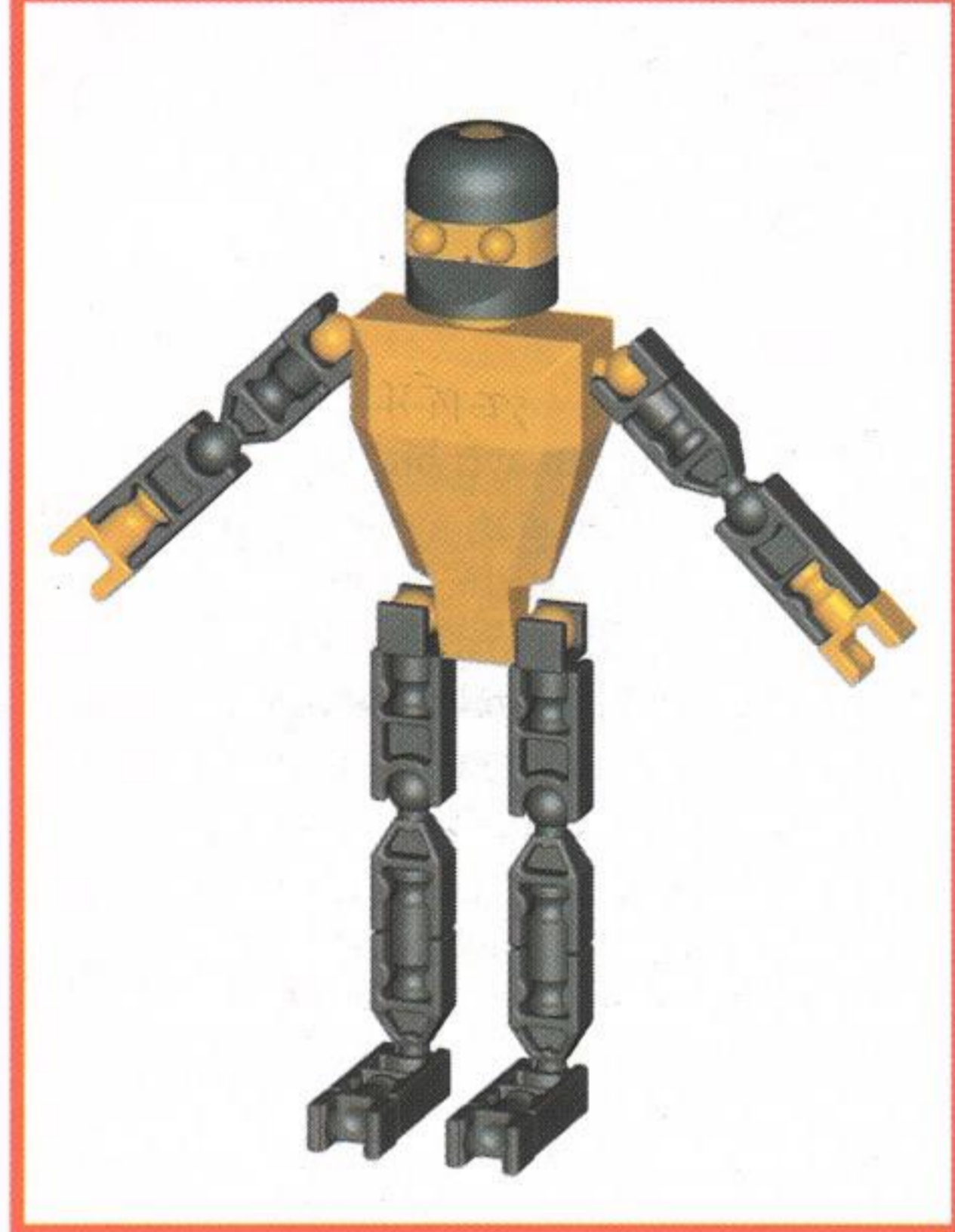

USA (GB) Options

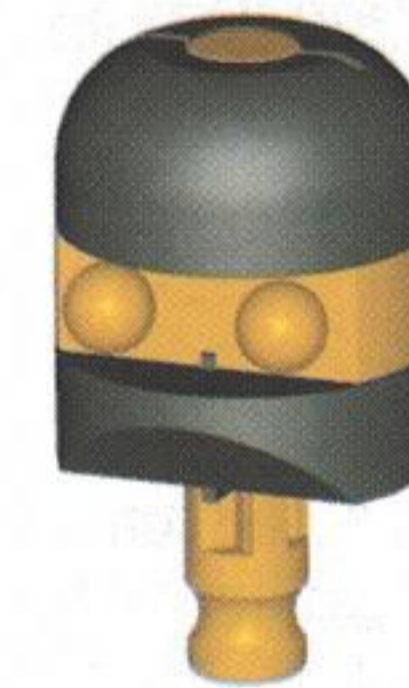

USA (GB) Push to snap together.

F Enfoncez les pièces pour les imbriquer.

I Spingere per incastrare.

D Teile zum Verbinden zusammenstecken.

E Empuja las piezas para que encajen a presión.

S Tryck ihop delarna tills de låses samman.

DK Skub delene ind i hinanden, til de siger klik.

N Skyv delene mot hverandre til de låses sammen.

SF Napsauta osat kiinni toisiinsa.

NL Druk op de onderdelen om ze in elkaar te klemmen.

P Empurre para encaixar.

G Πιέστε για να τα ενώσετε.

TR İttirerek birbirbine birleştirin.

J 押しながらはめ込みます。

CHI 將兩邊啪嗒一聲推在一起。

IL לחיבור החלקים, לחץ.



Scooter

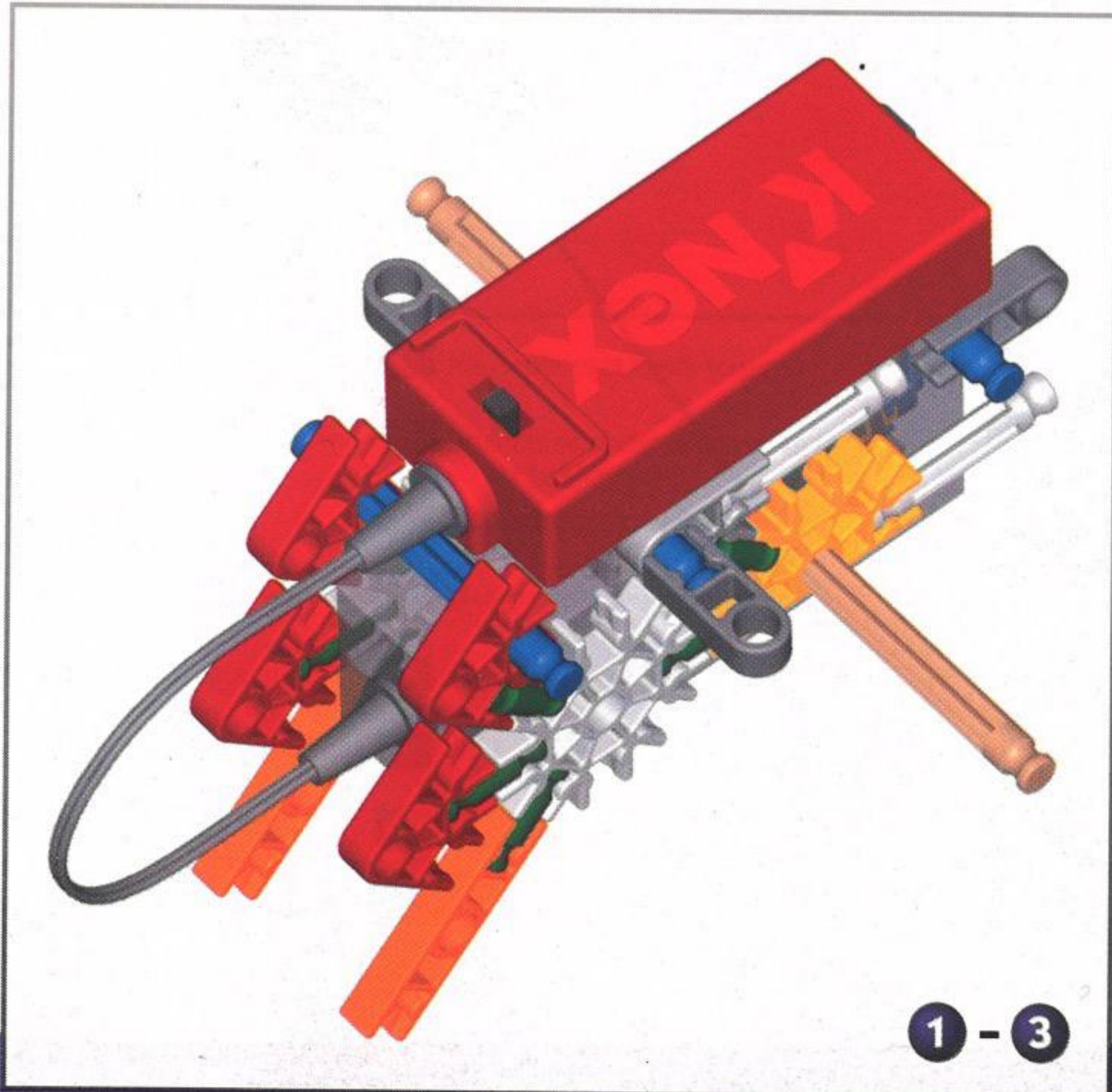
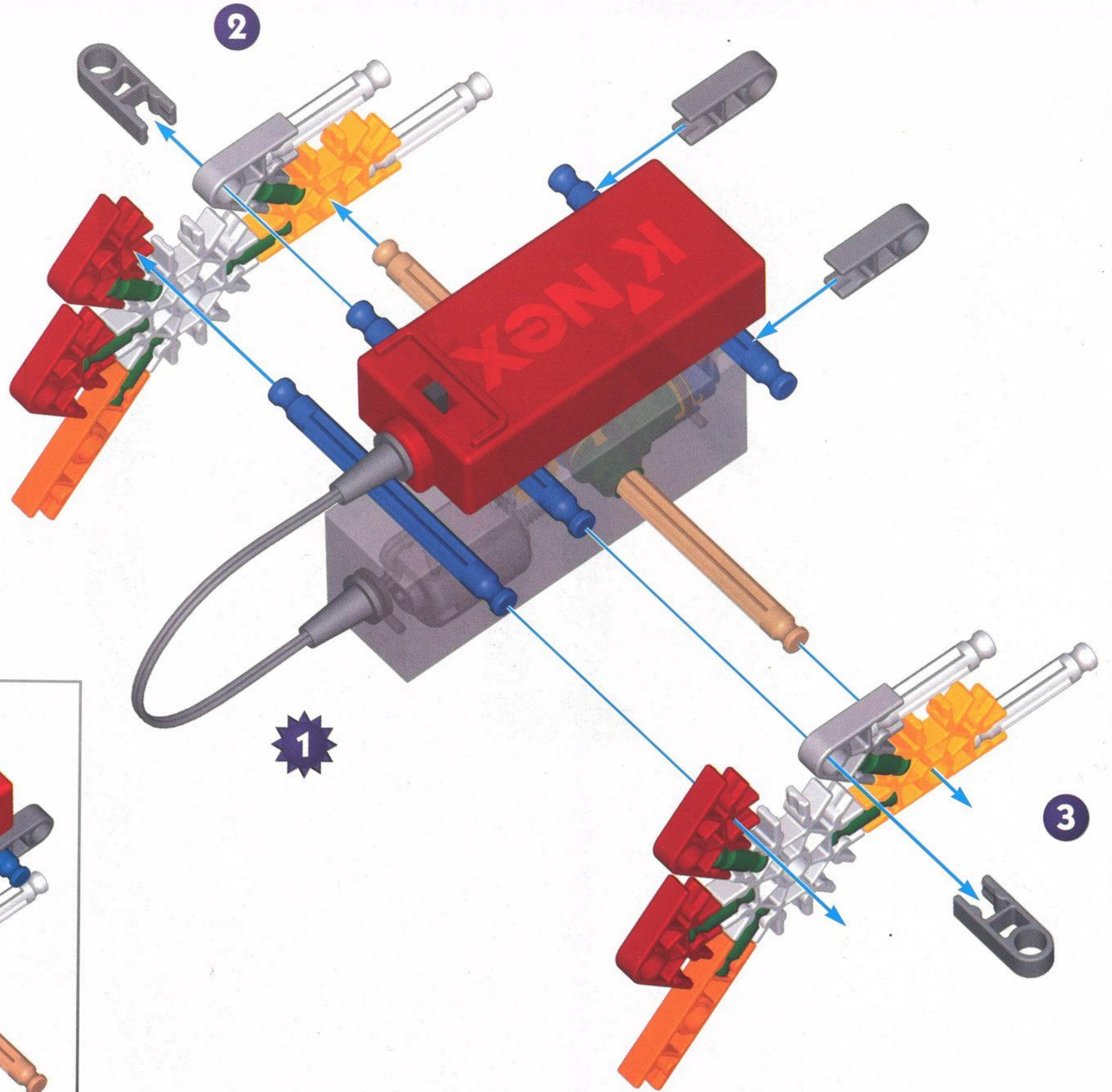

1 - 3

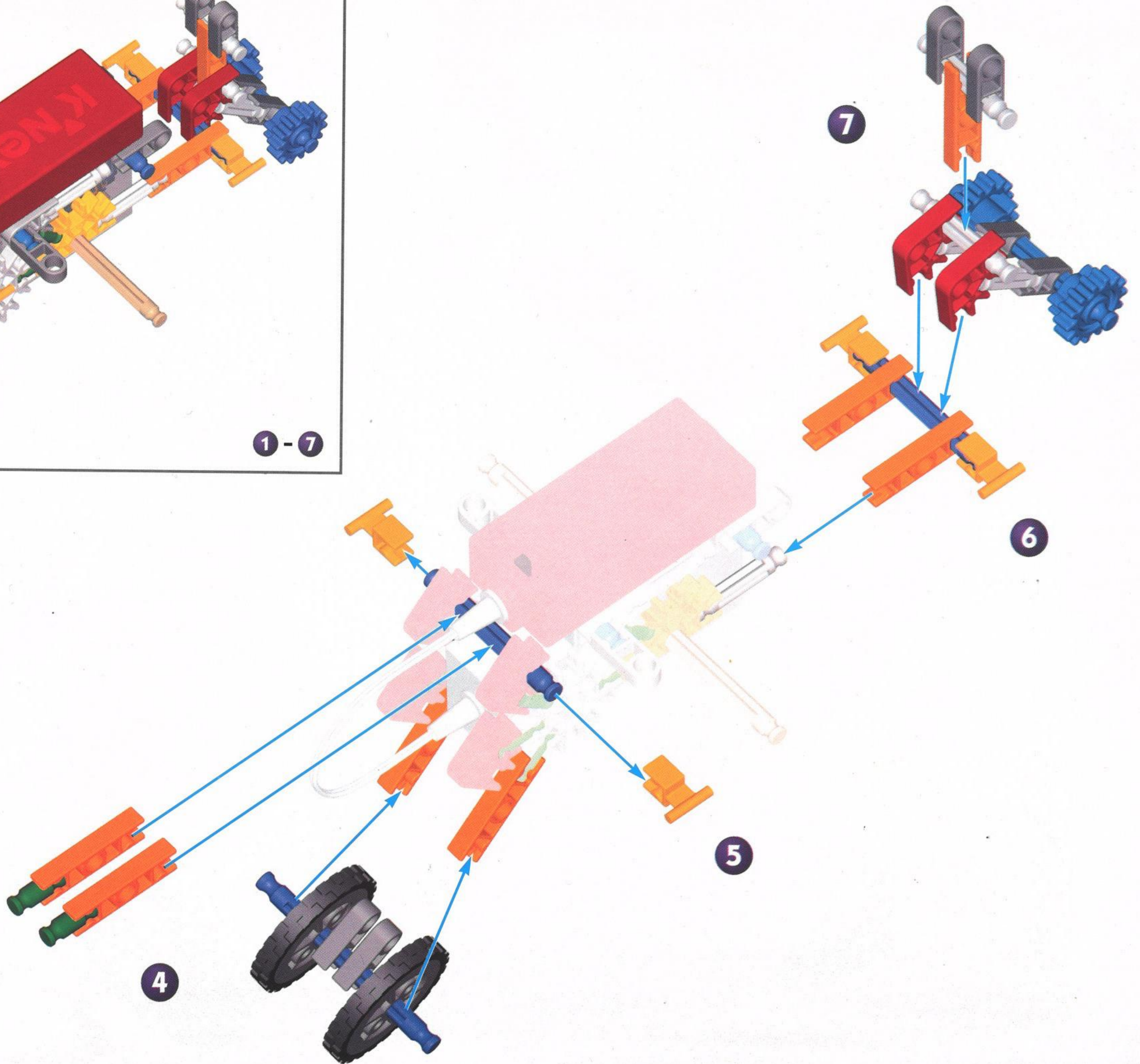
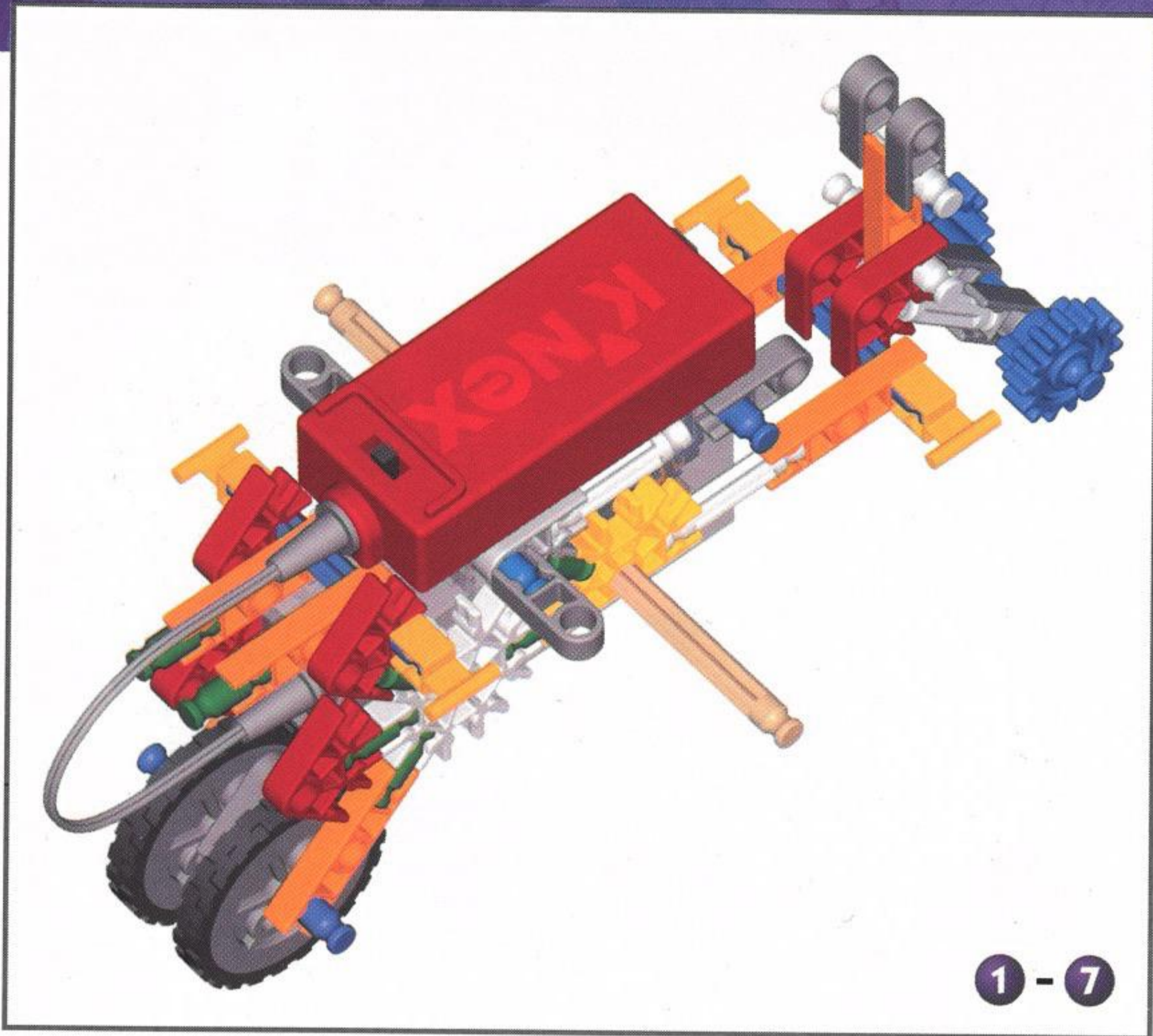

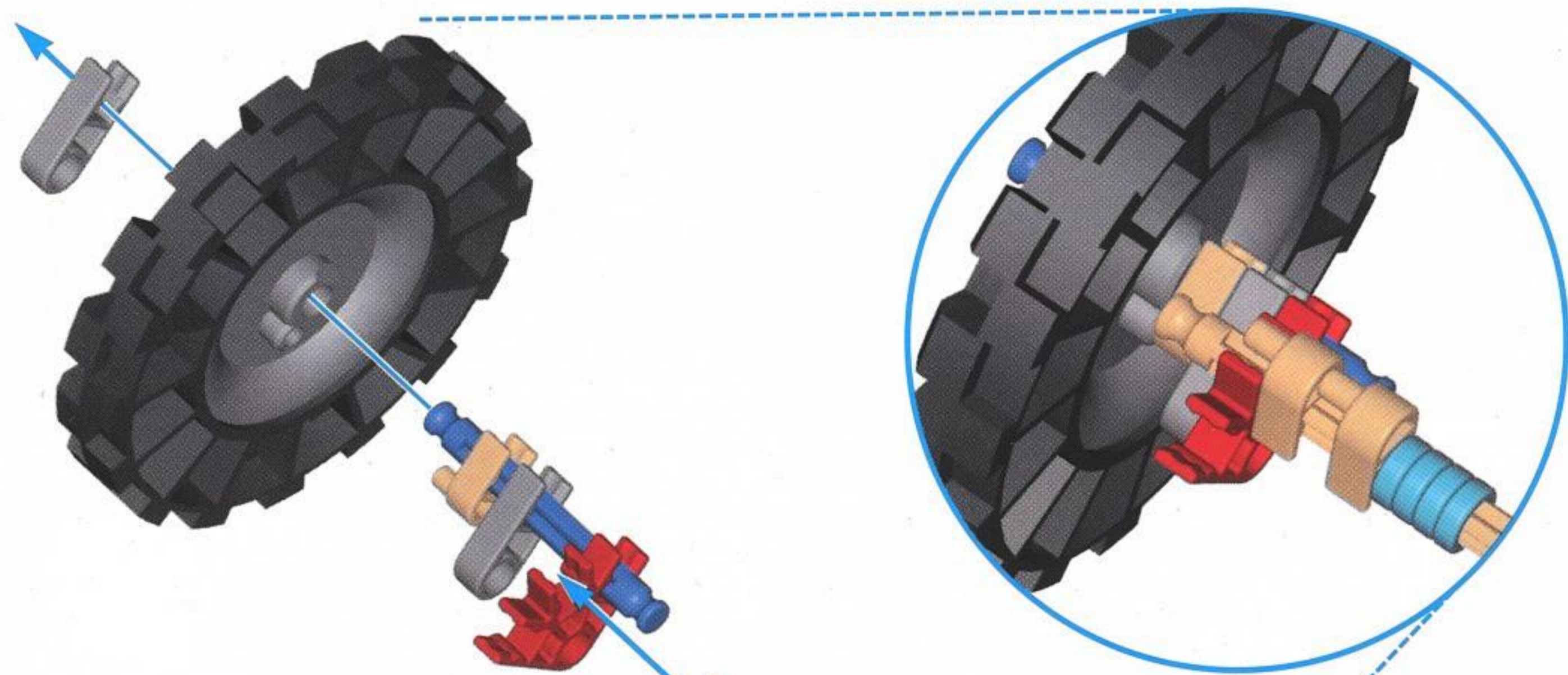

8

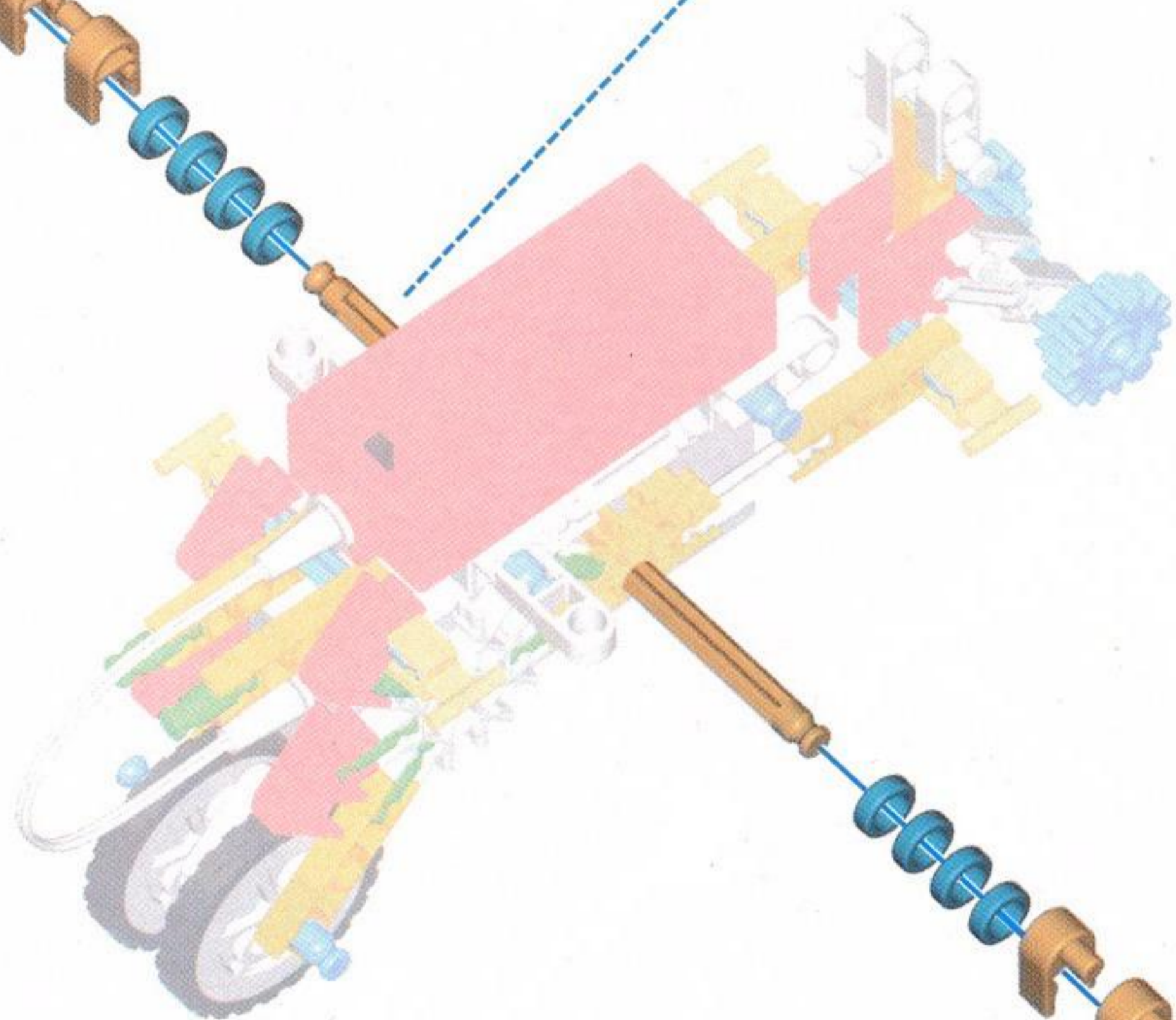

9

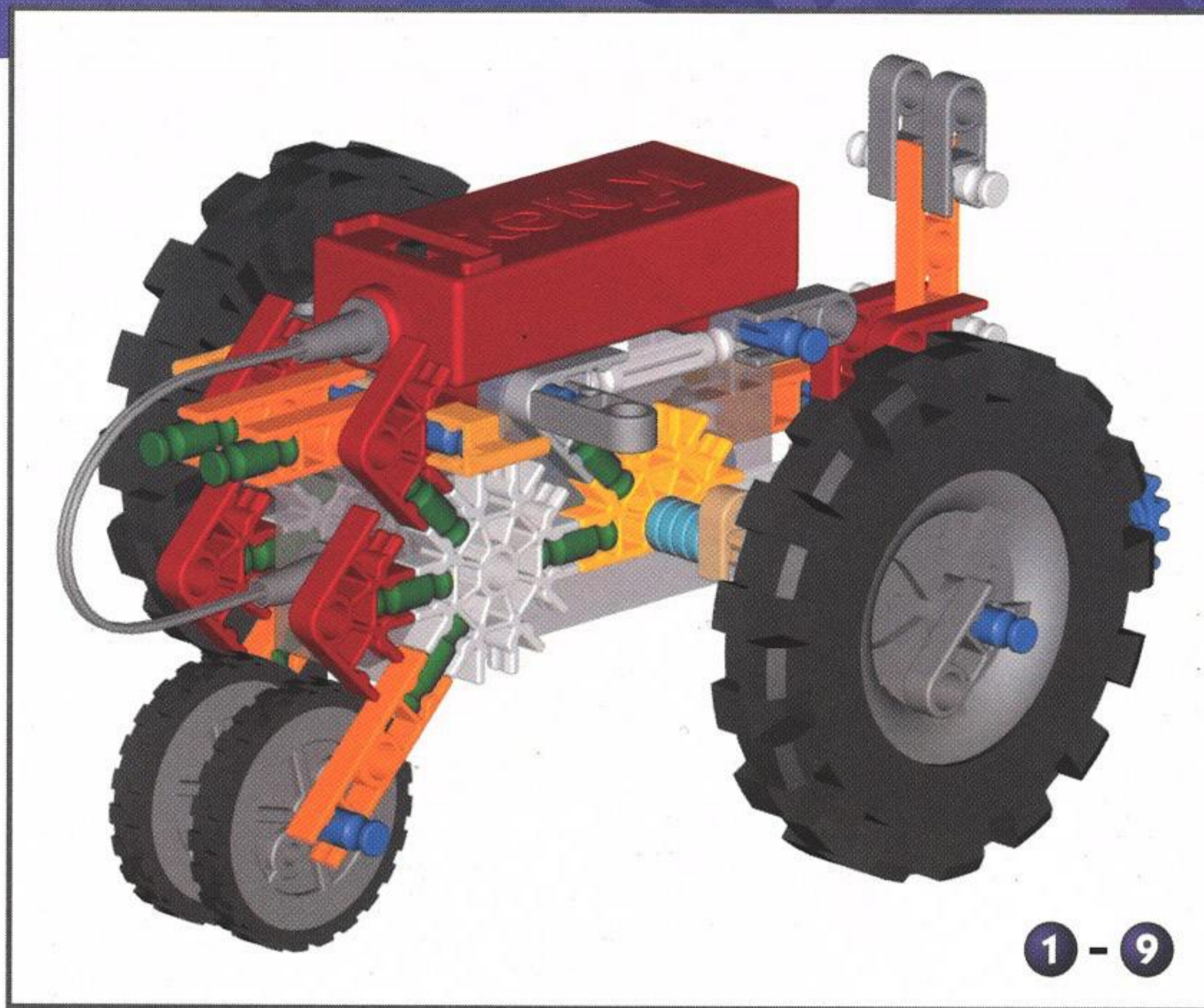
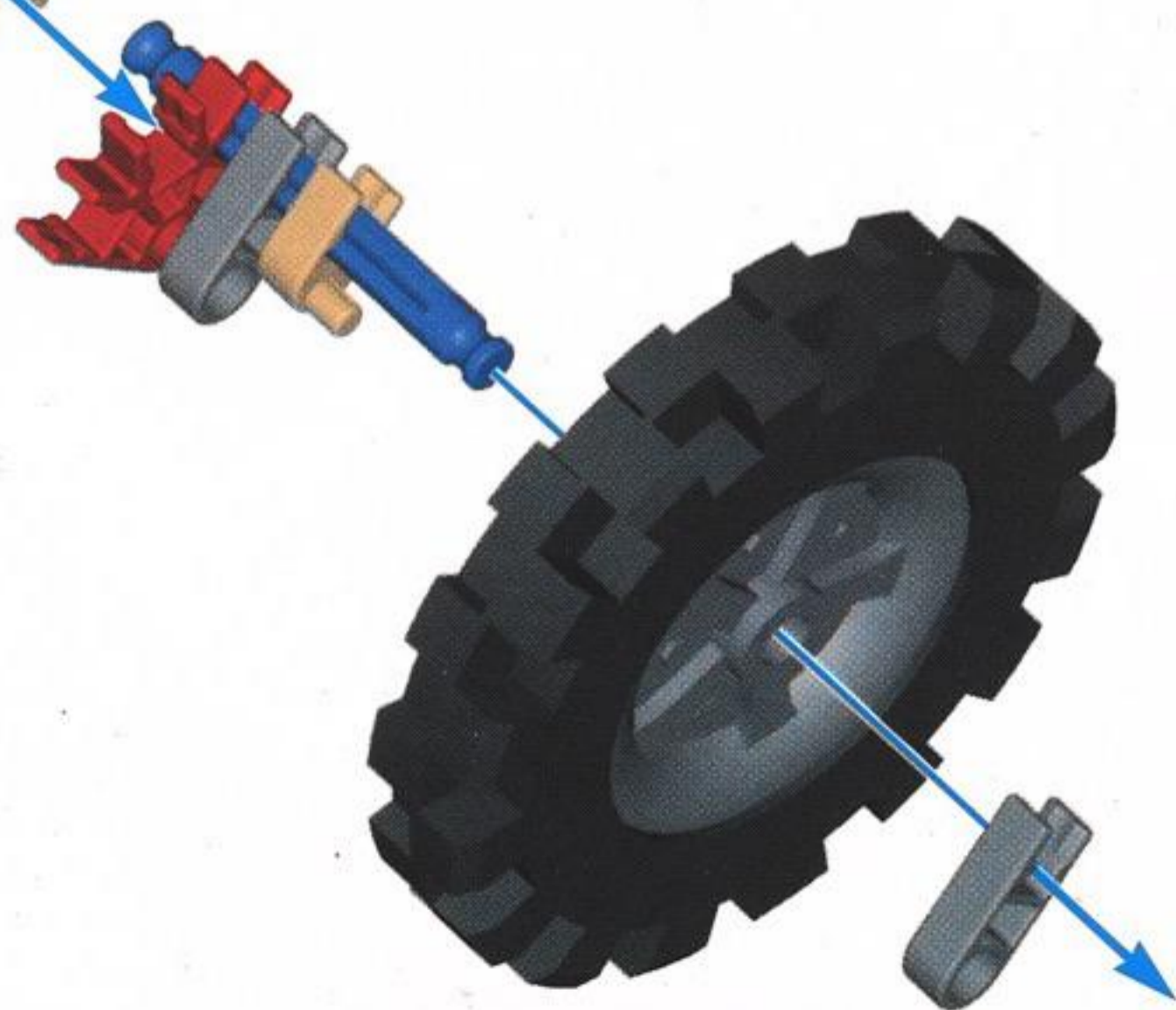

1 - 9

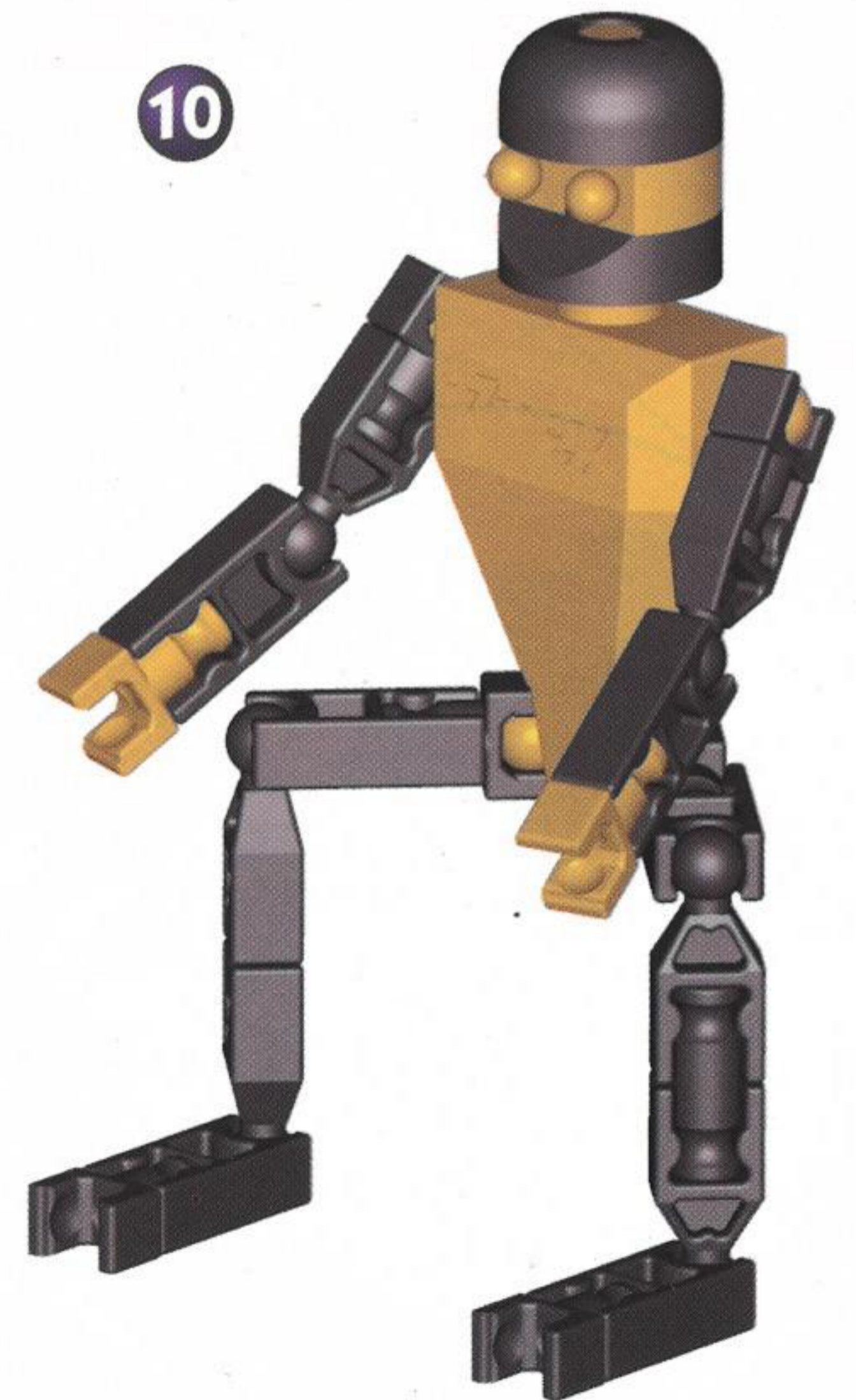
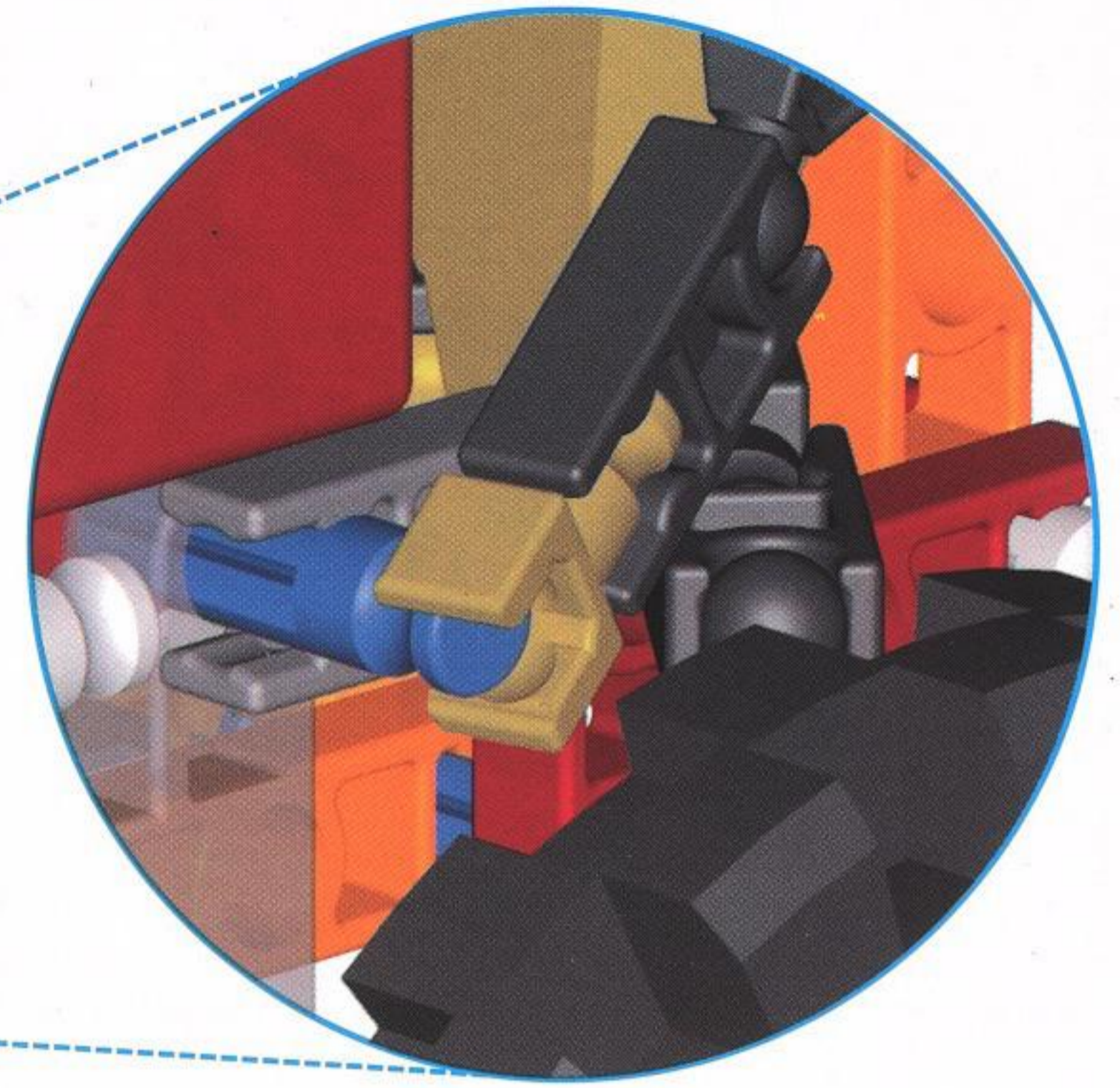
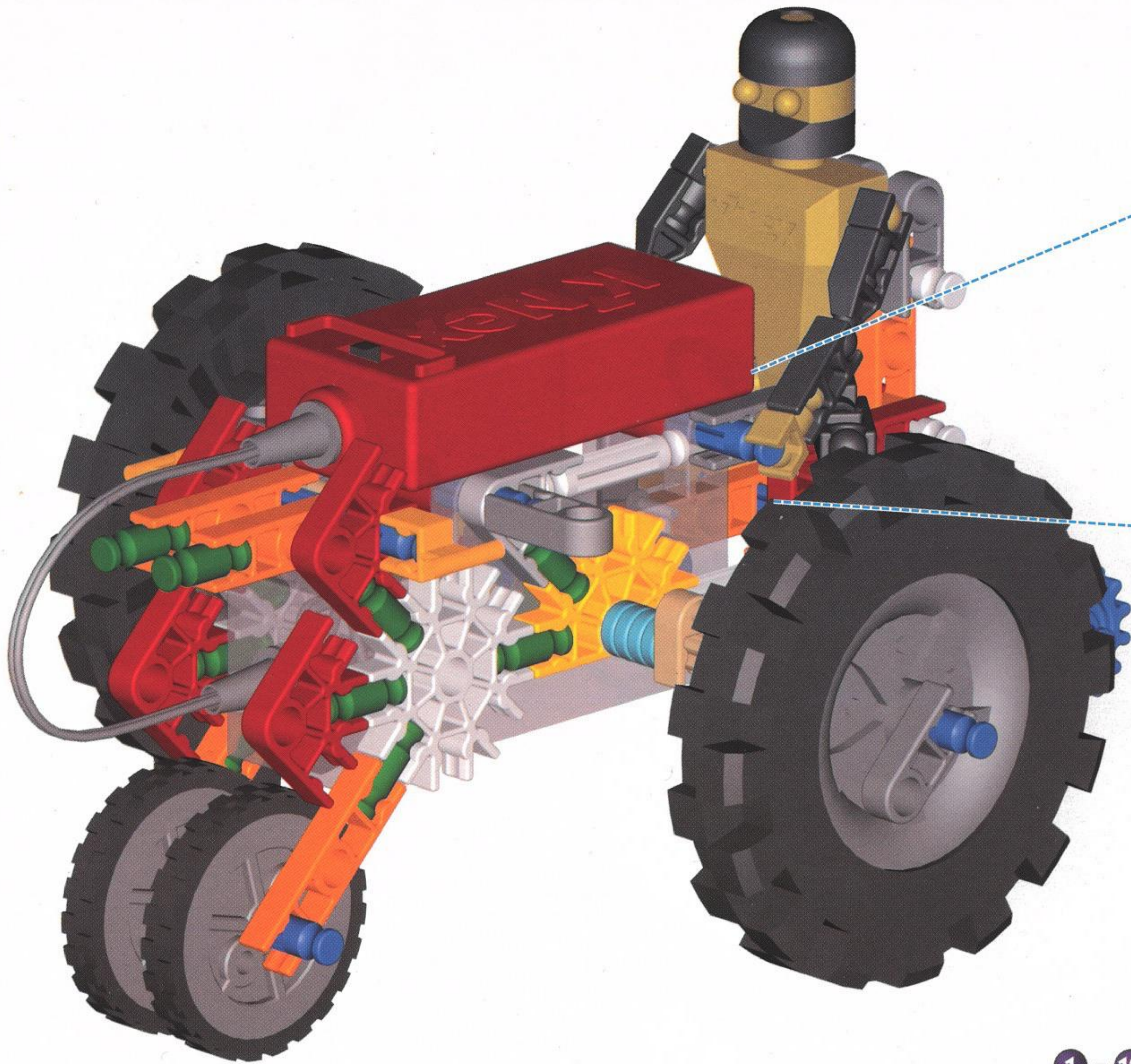

Roller

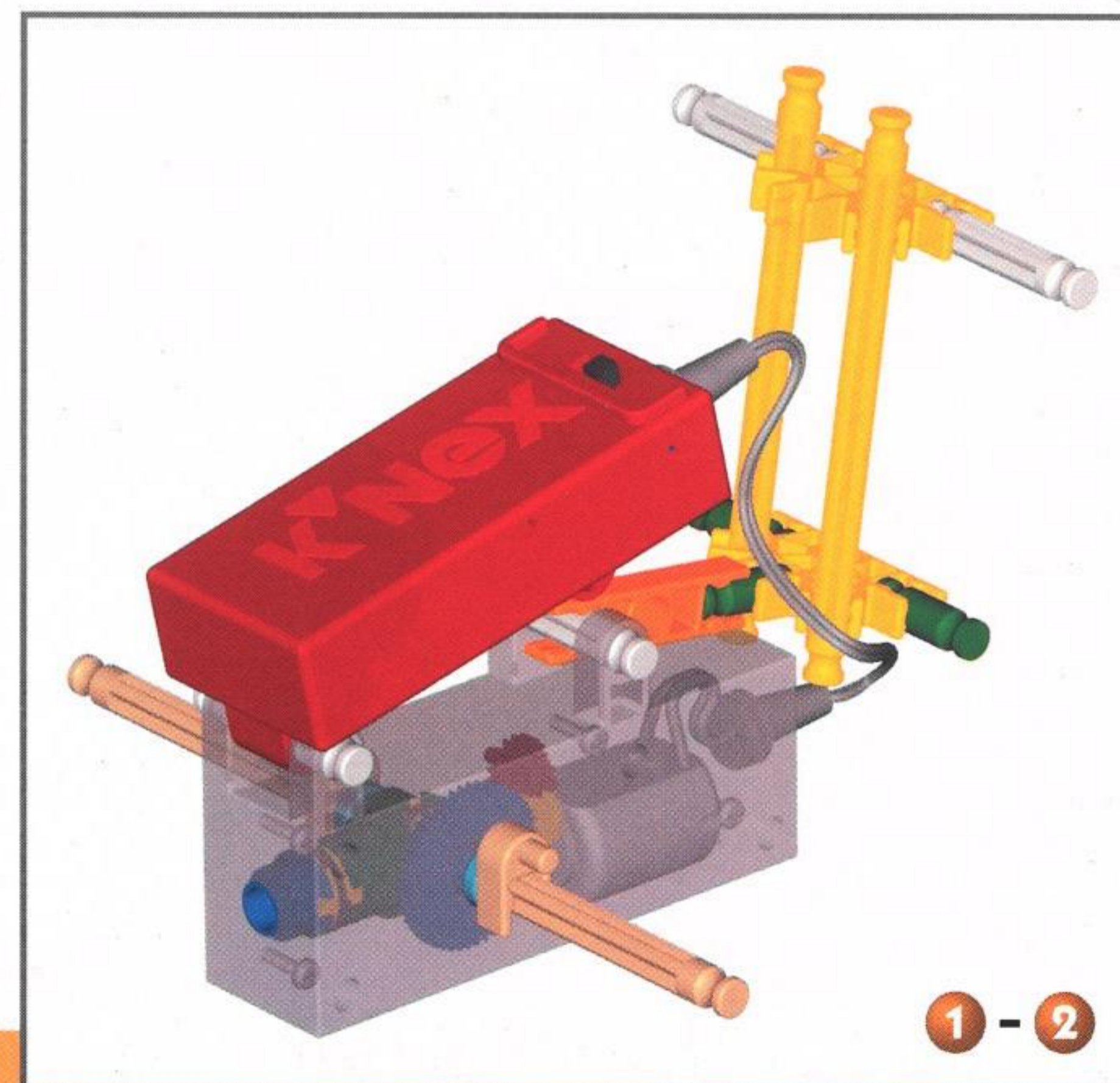
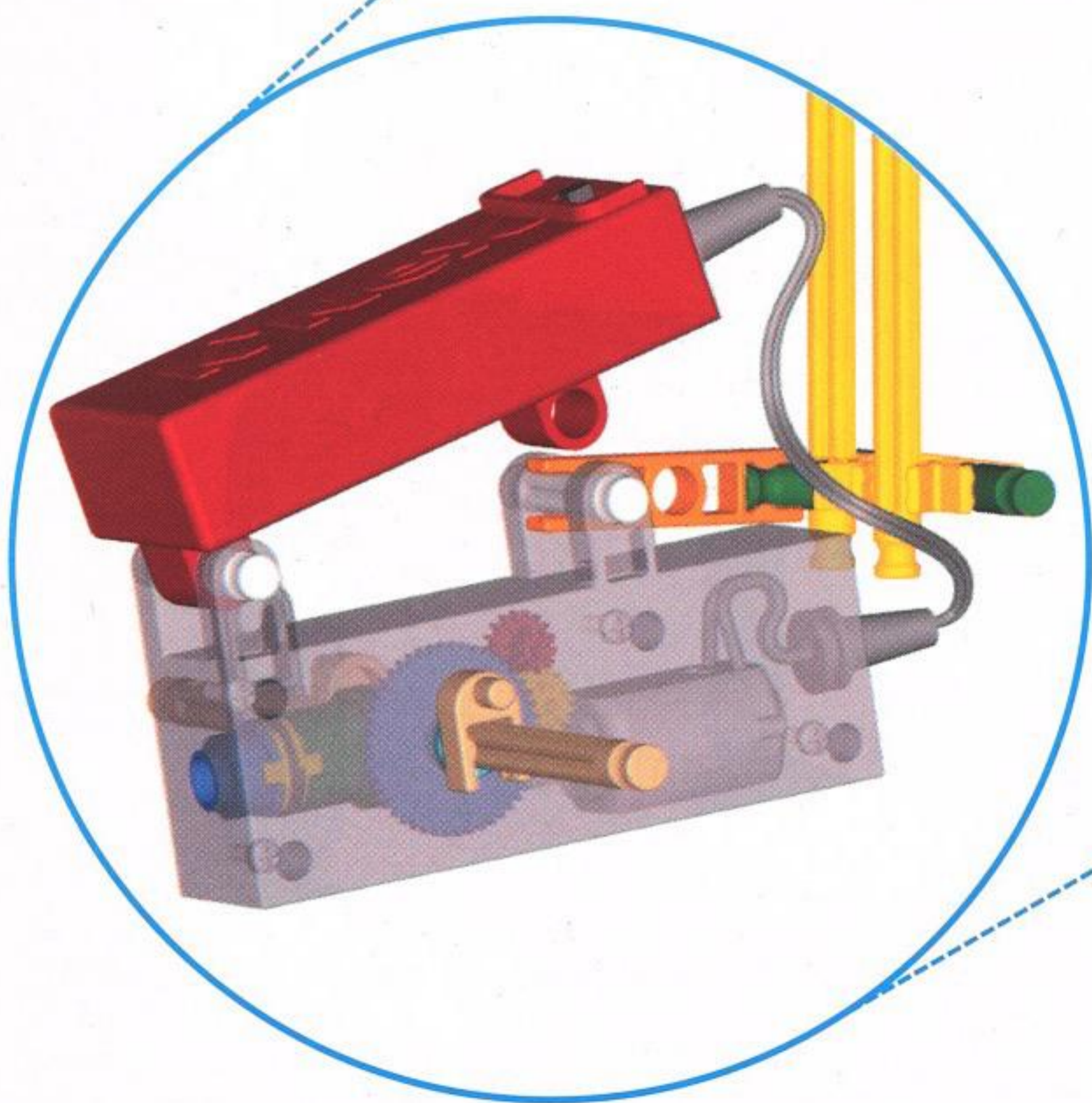
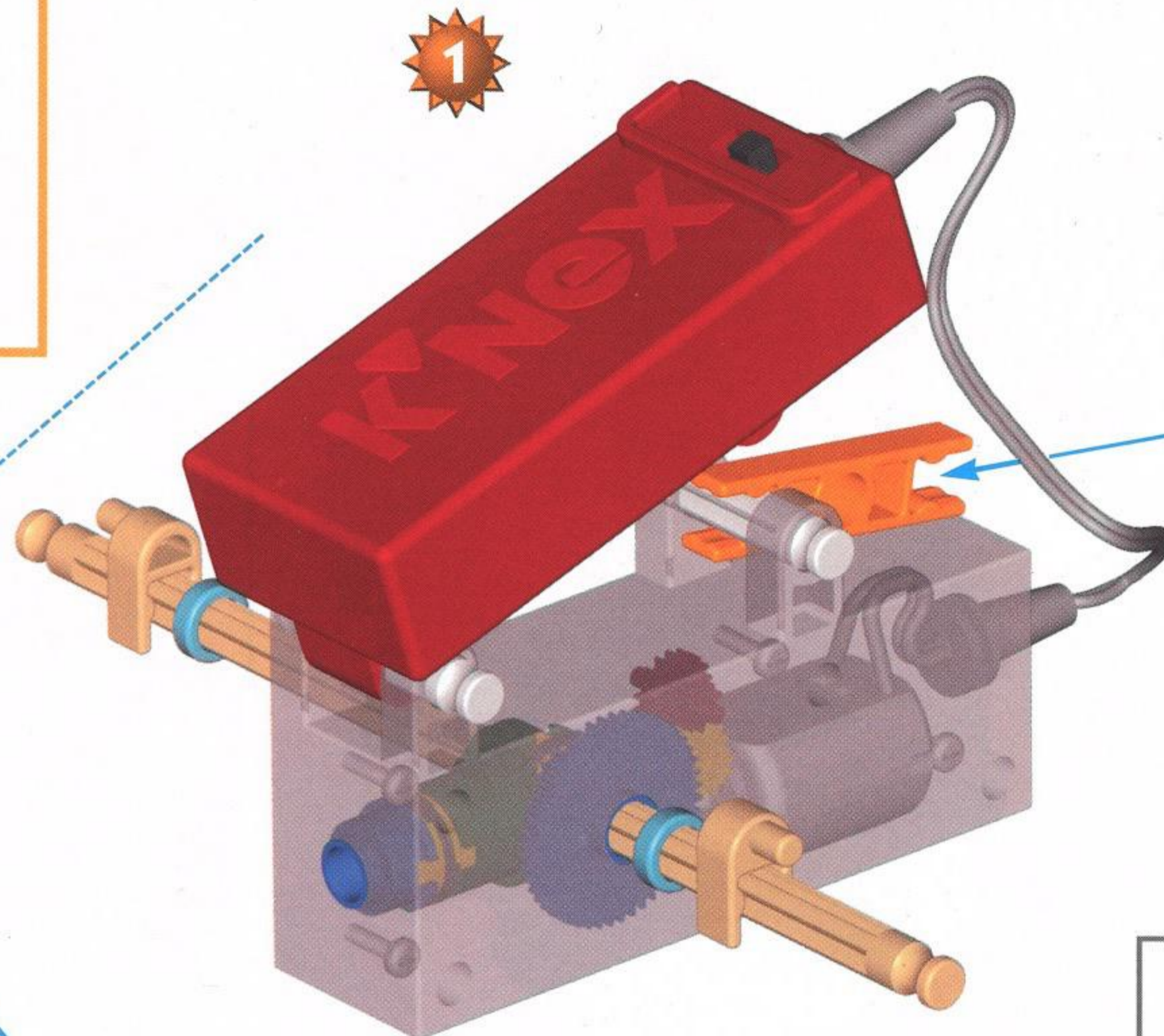
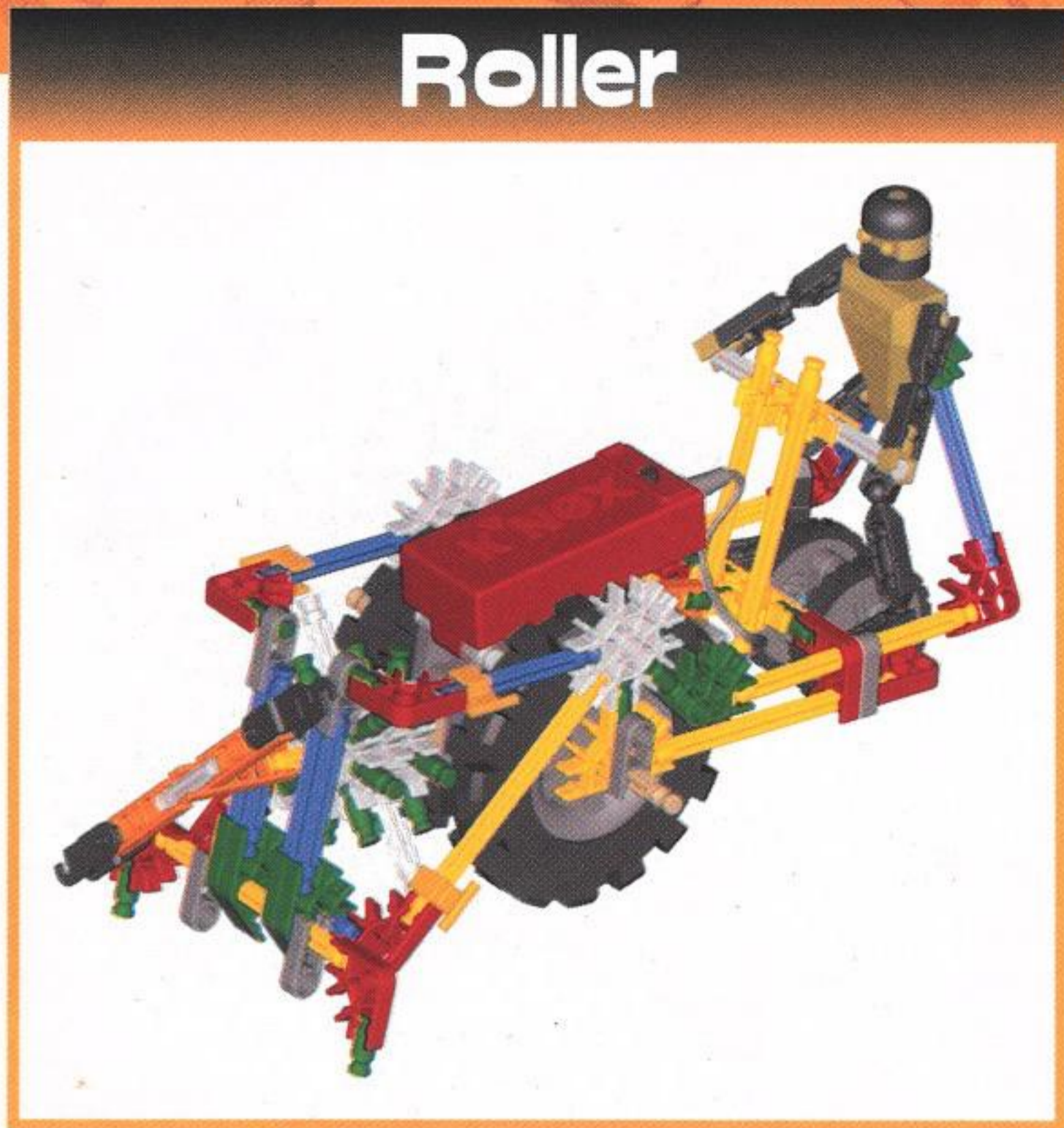

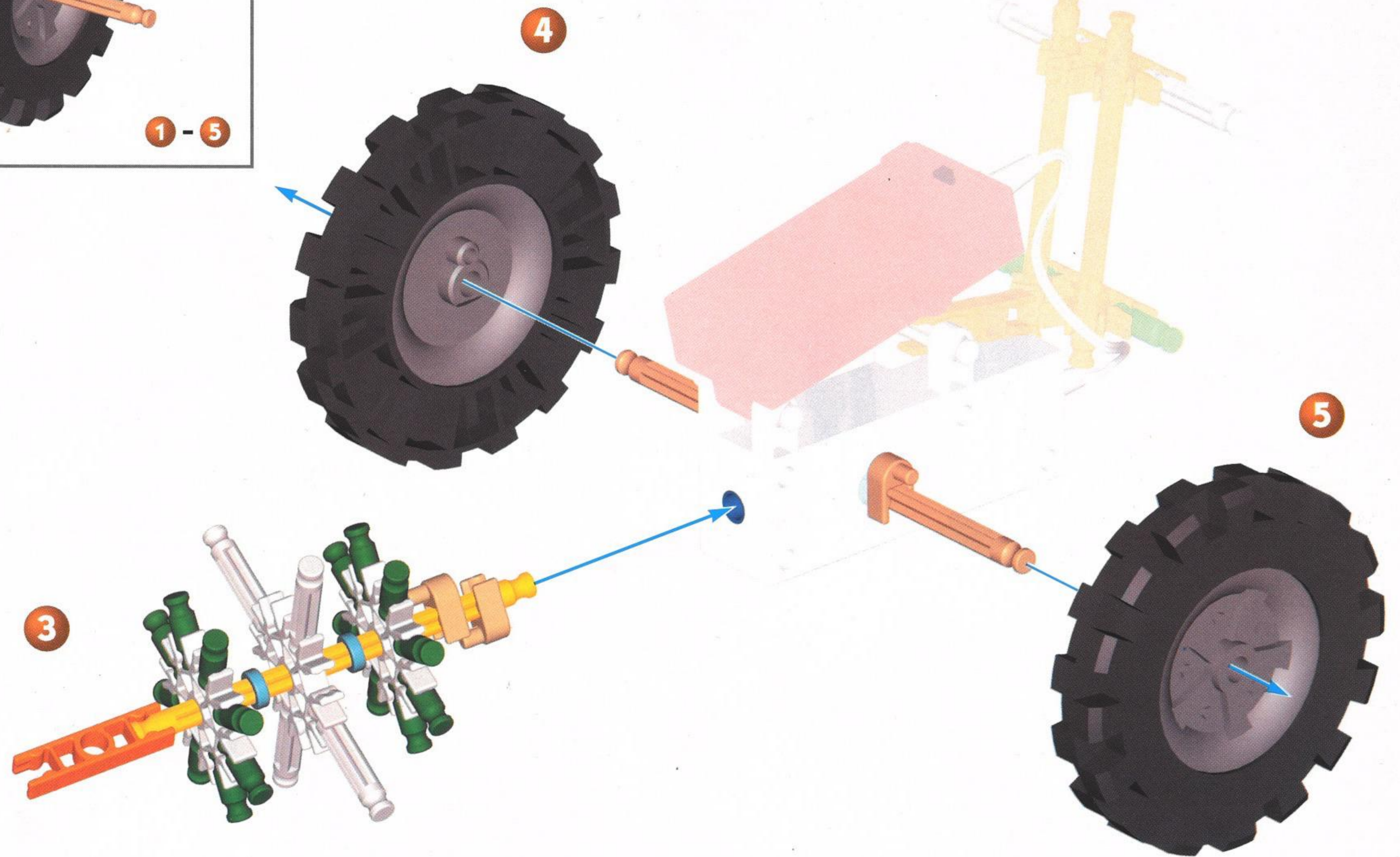



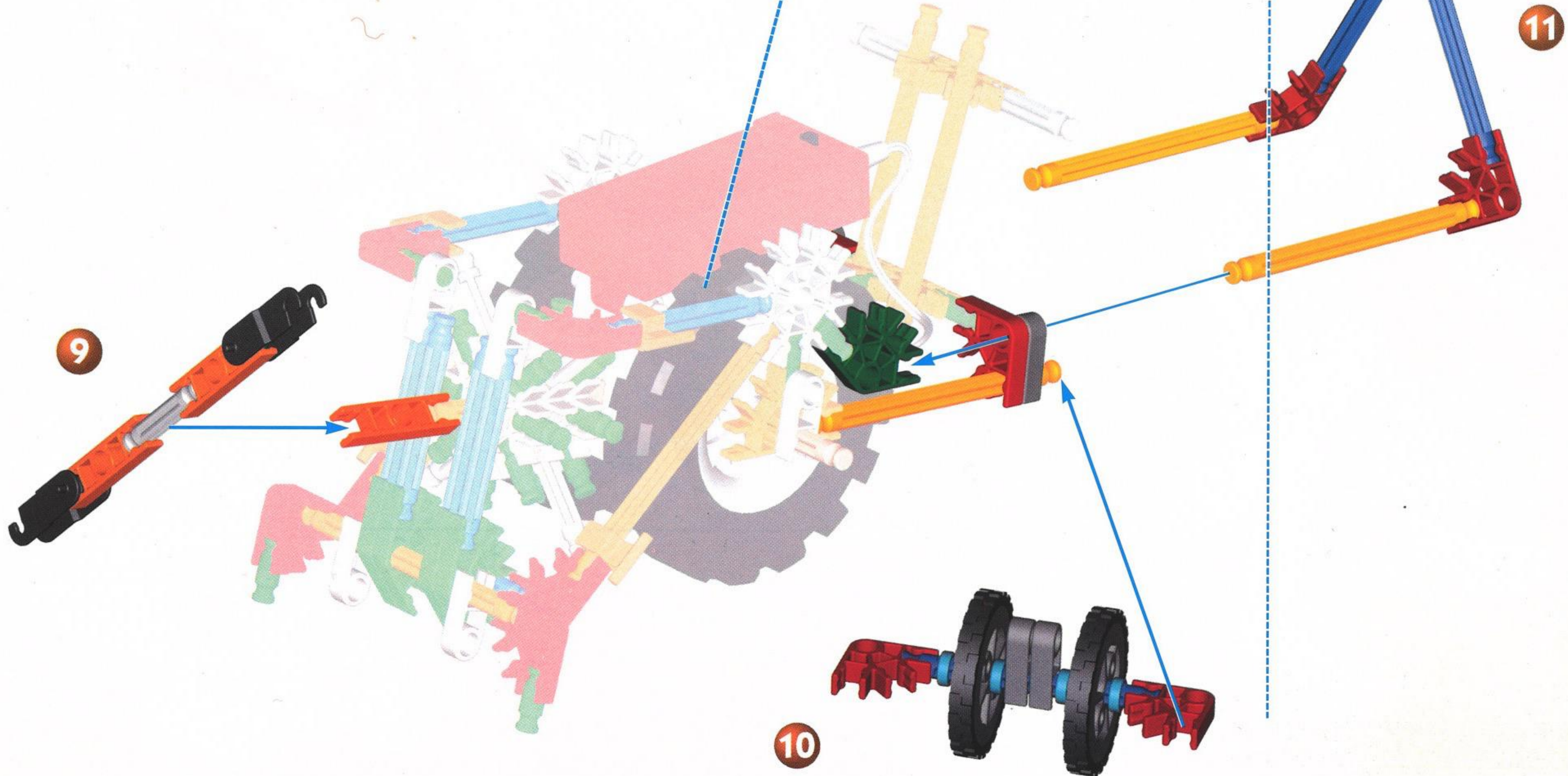
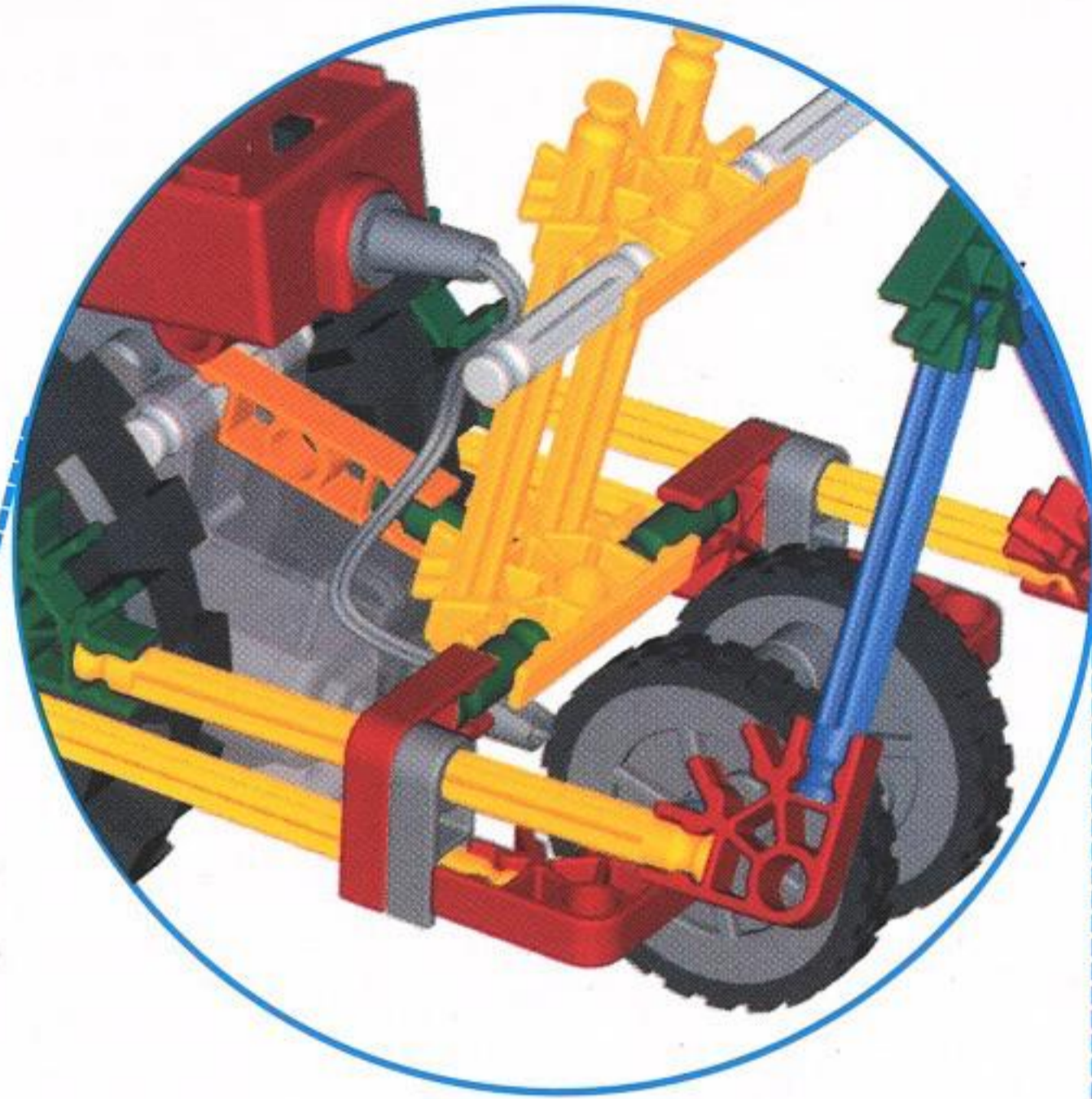

12



1 - 12

Zoomer

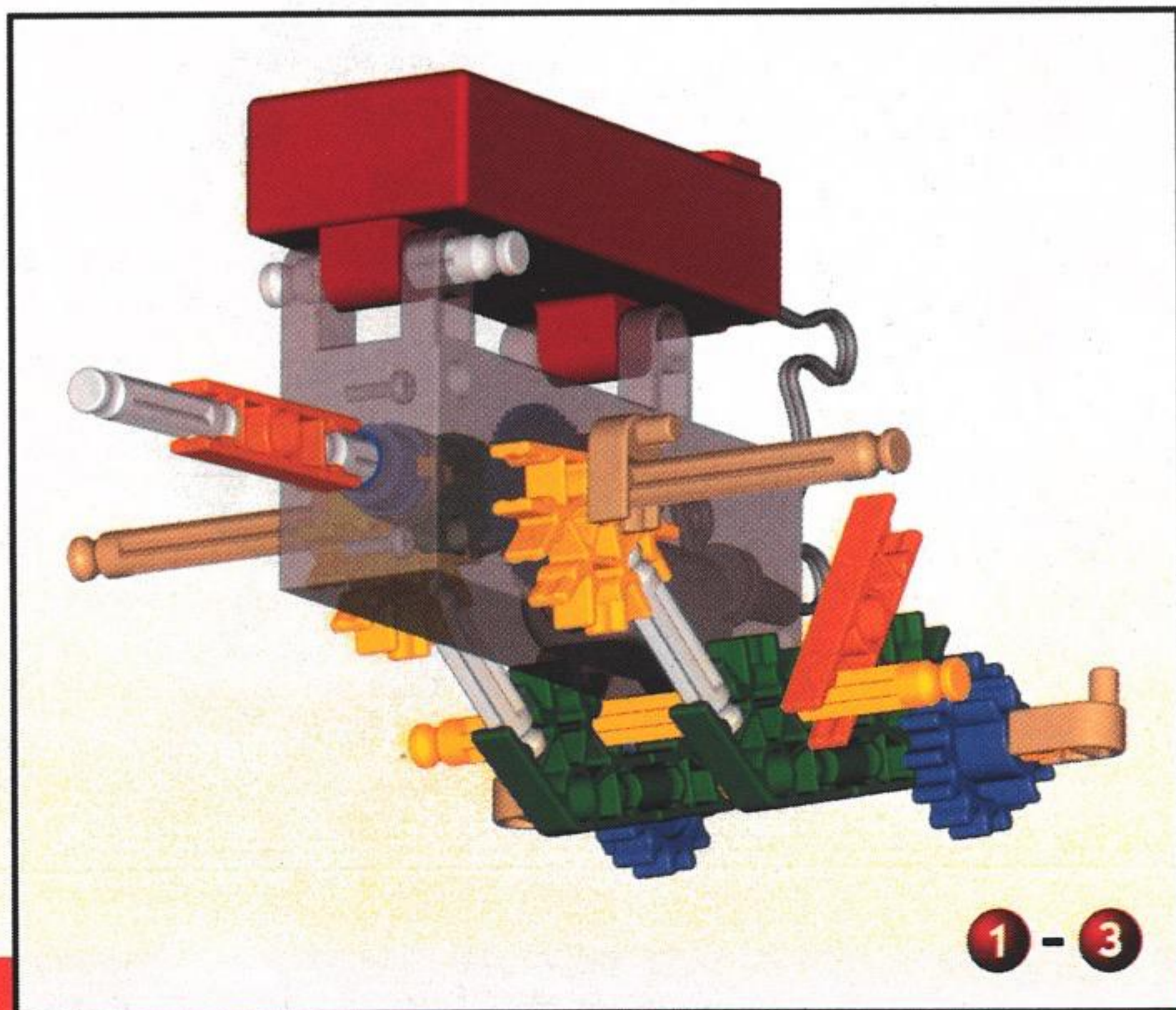
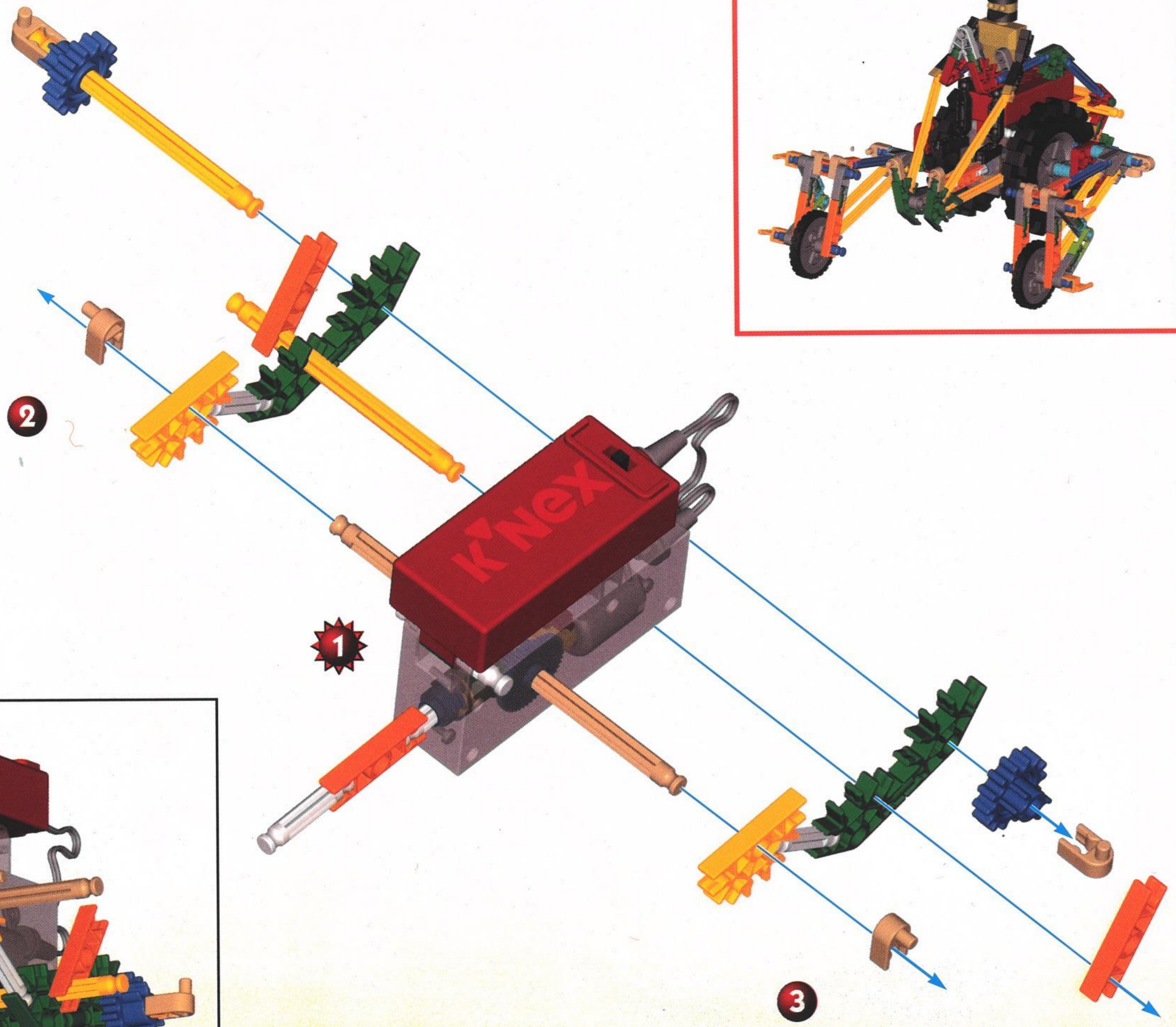

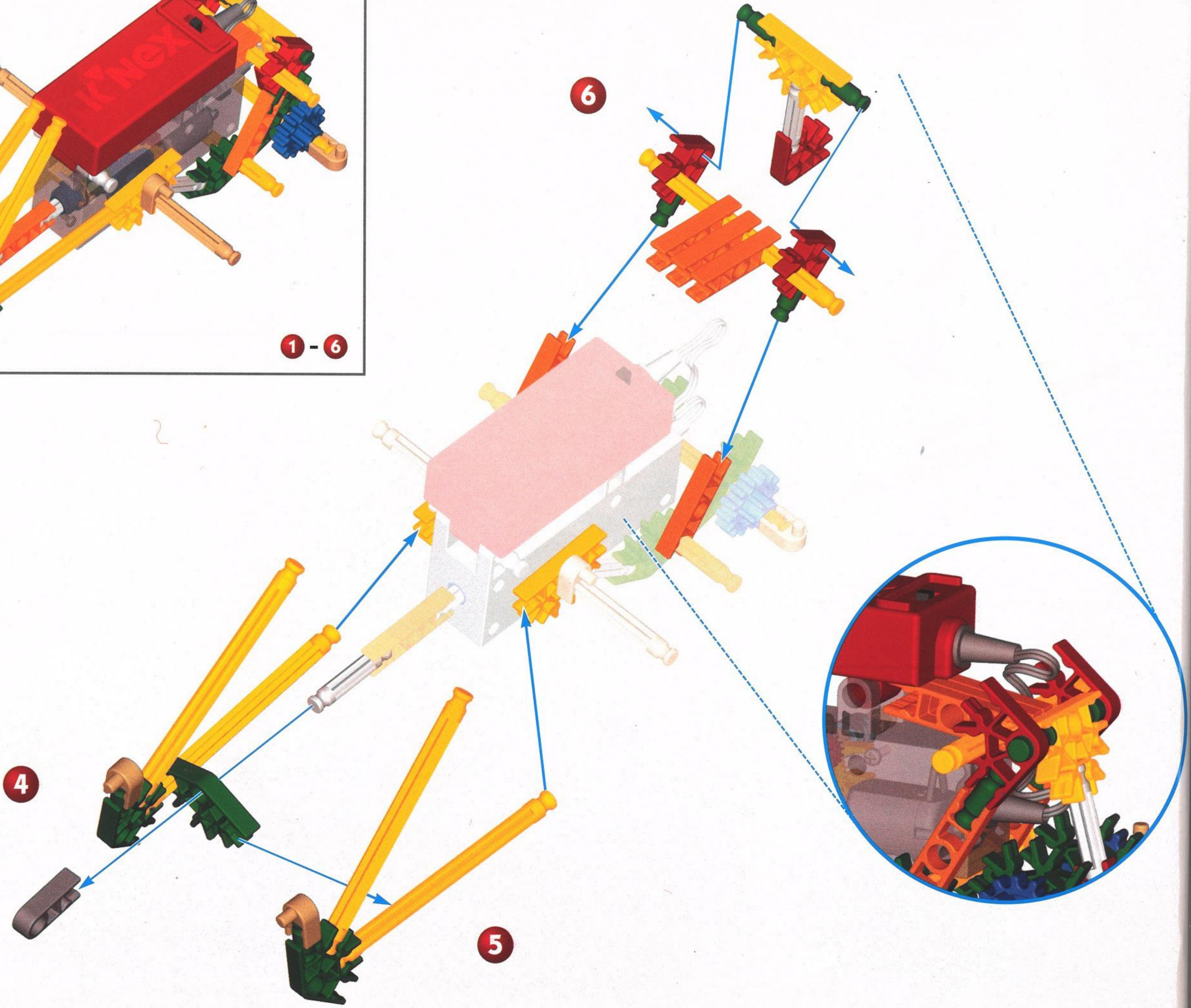
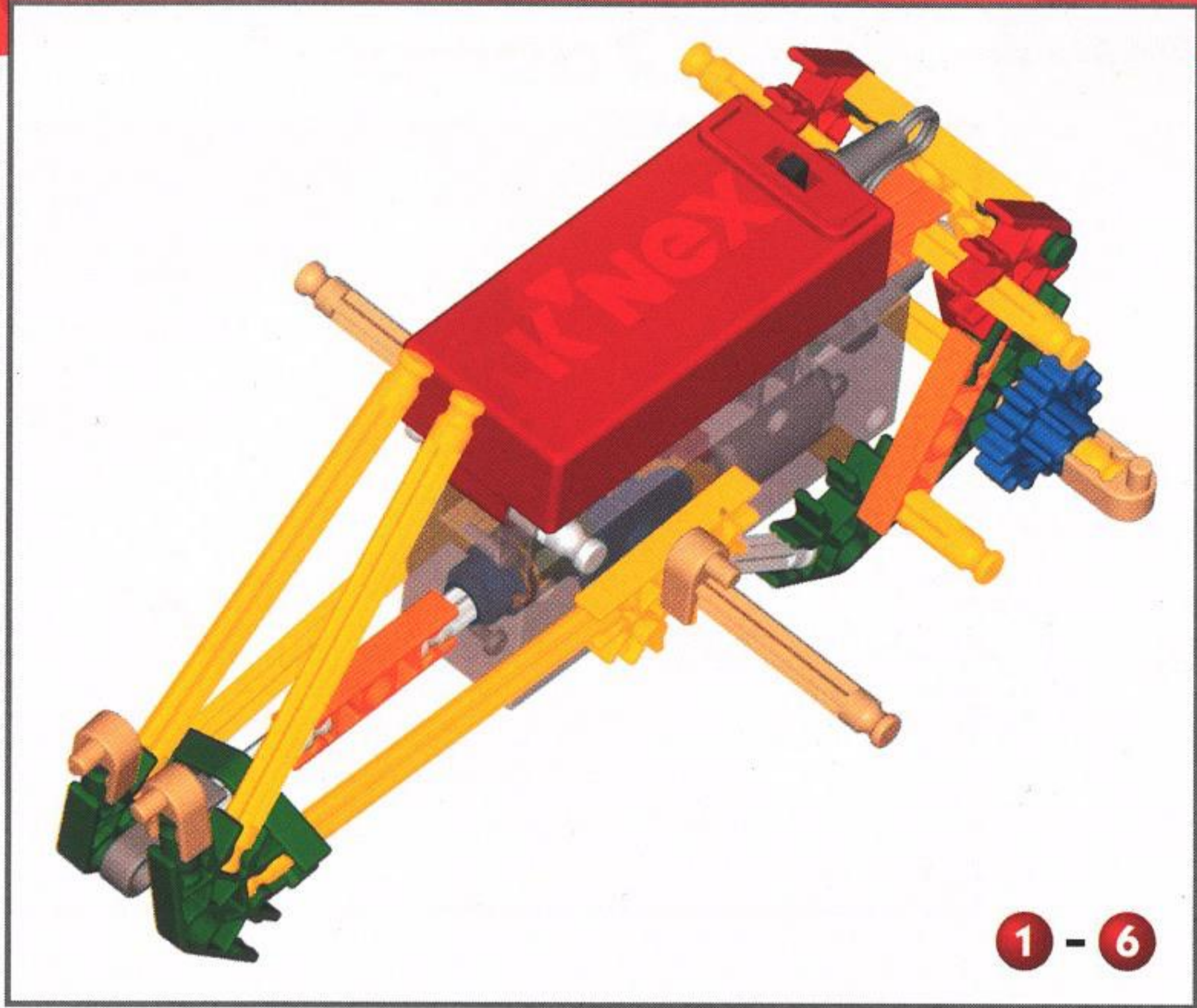

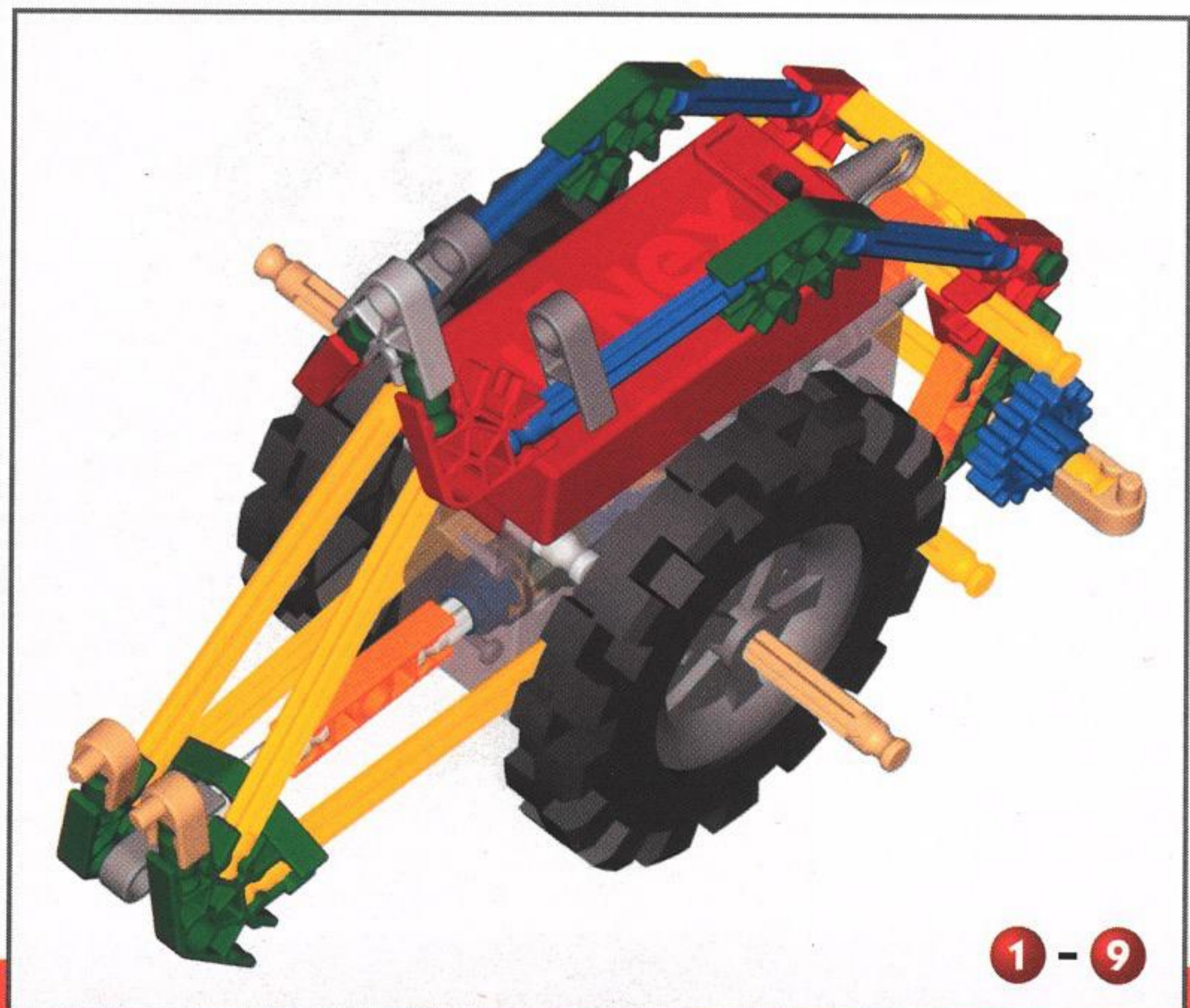
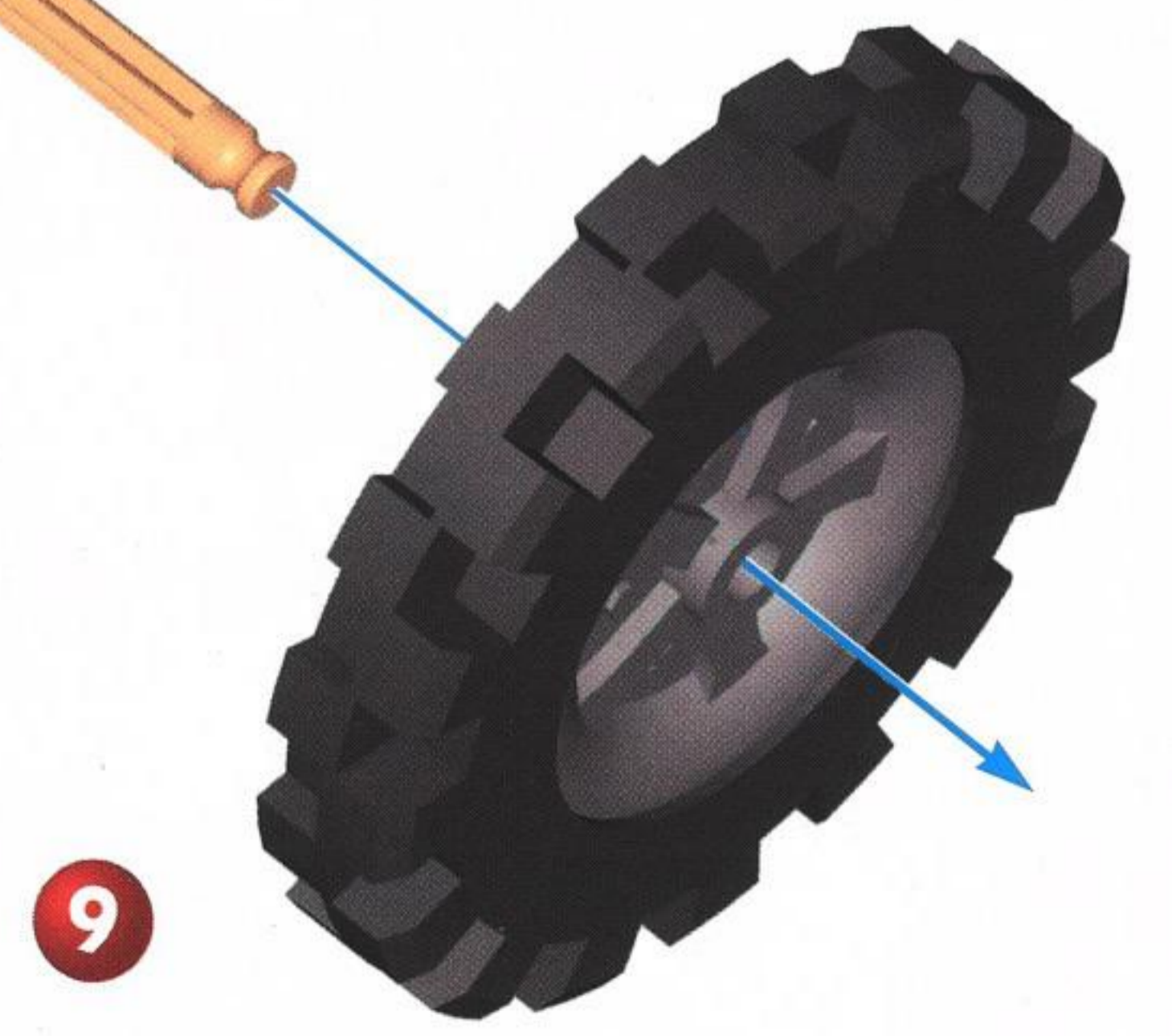
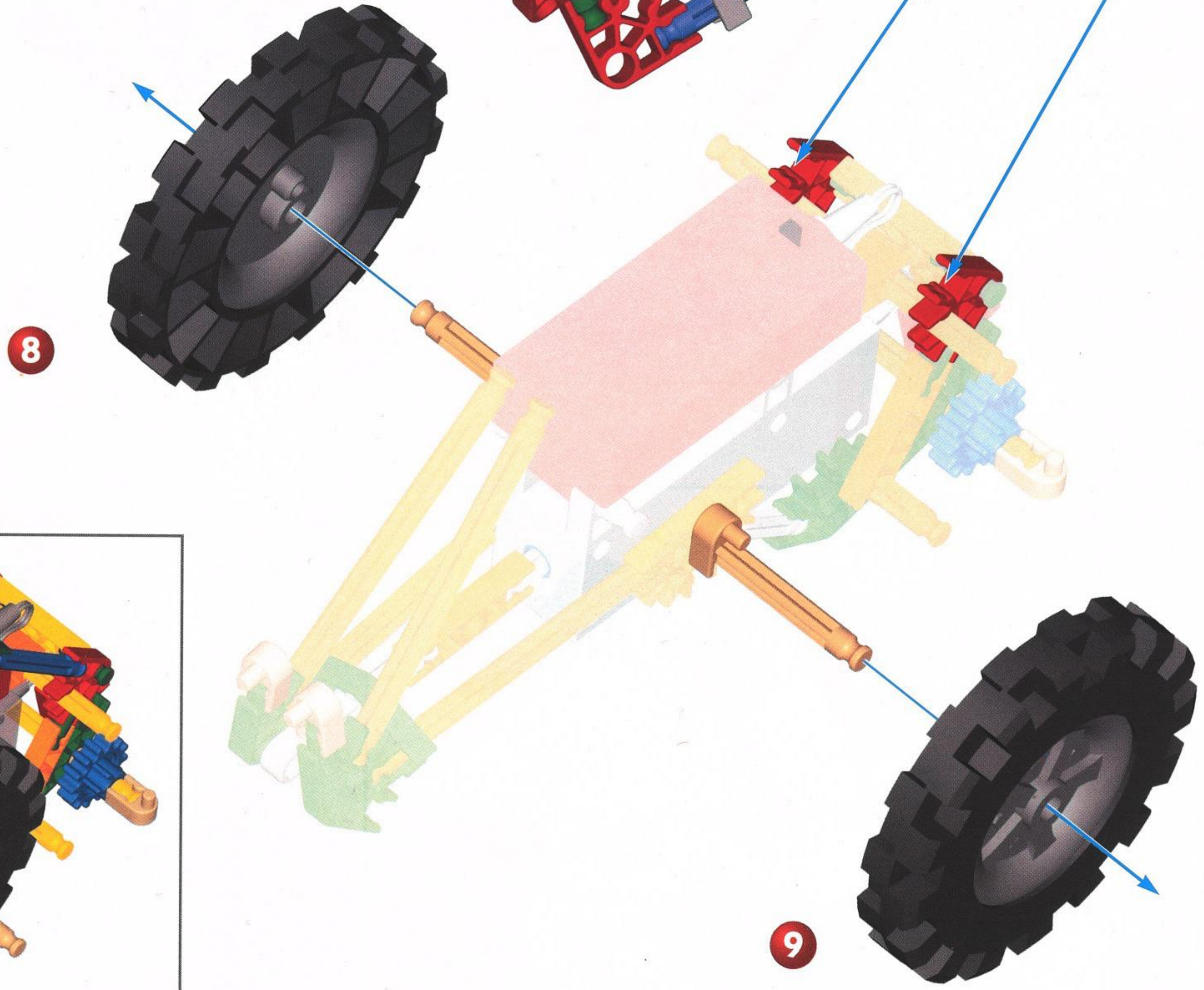
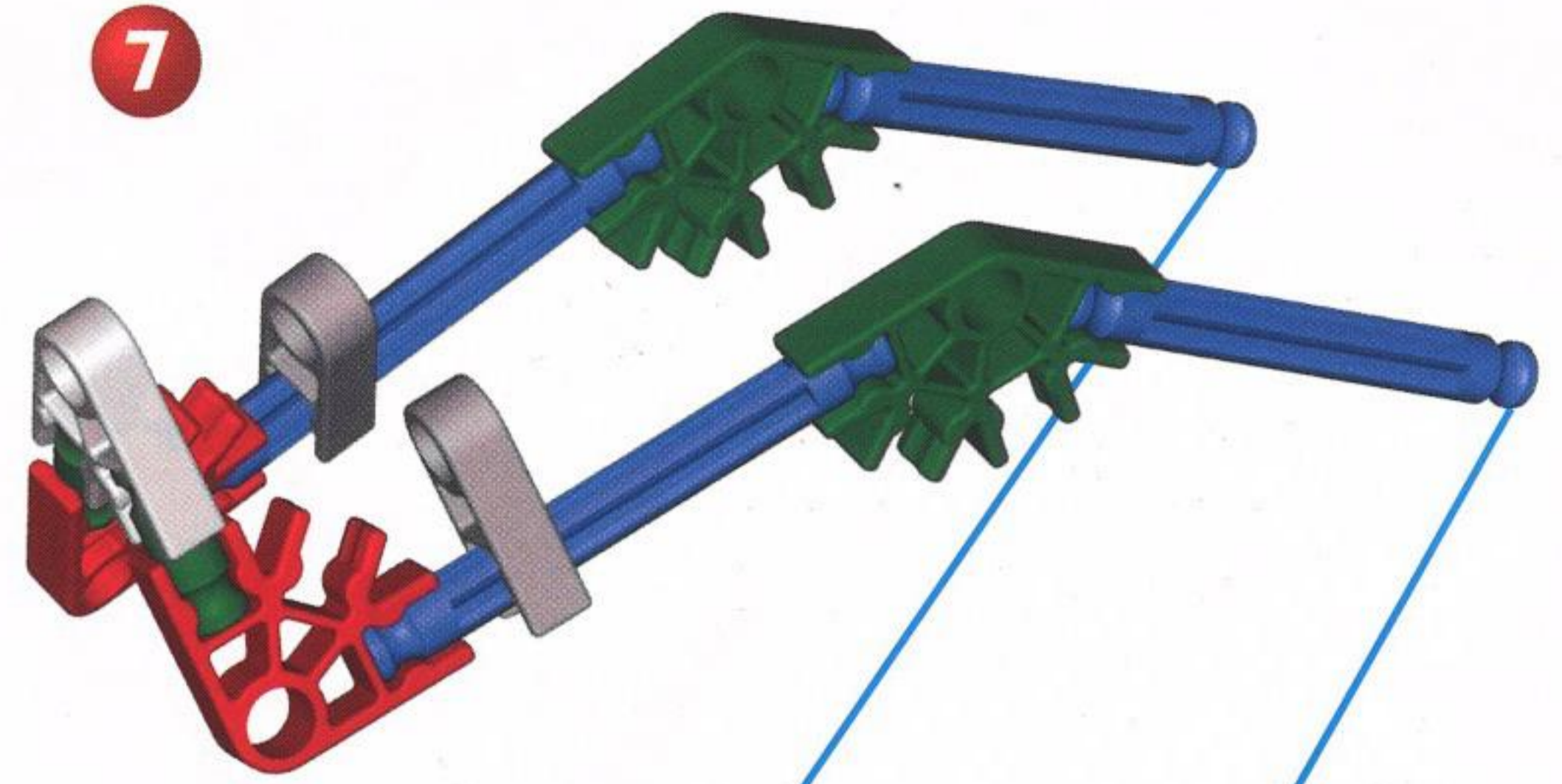

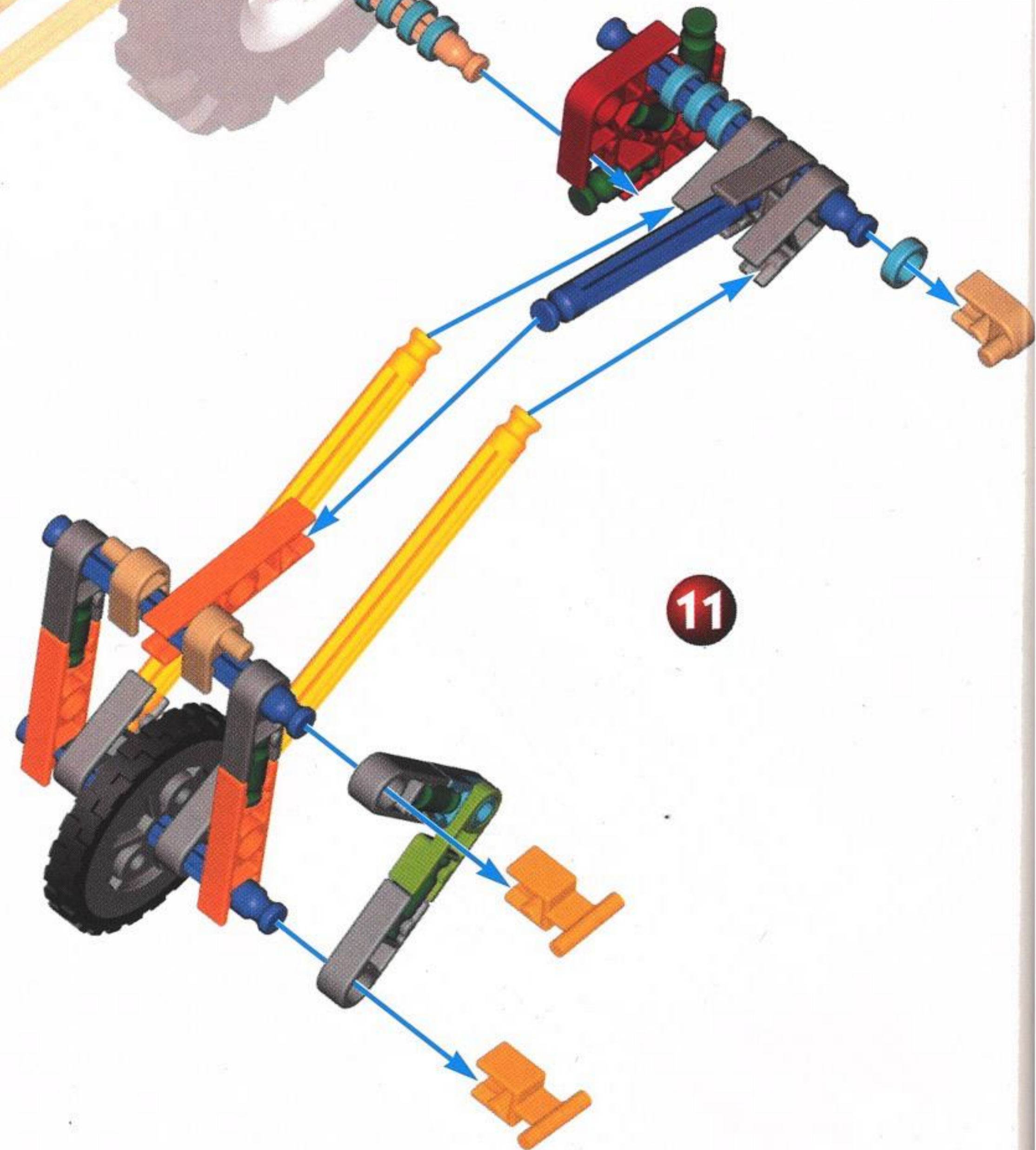
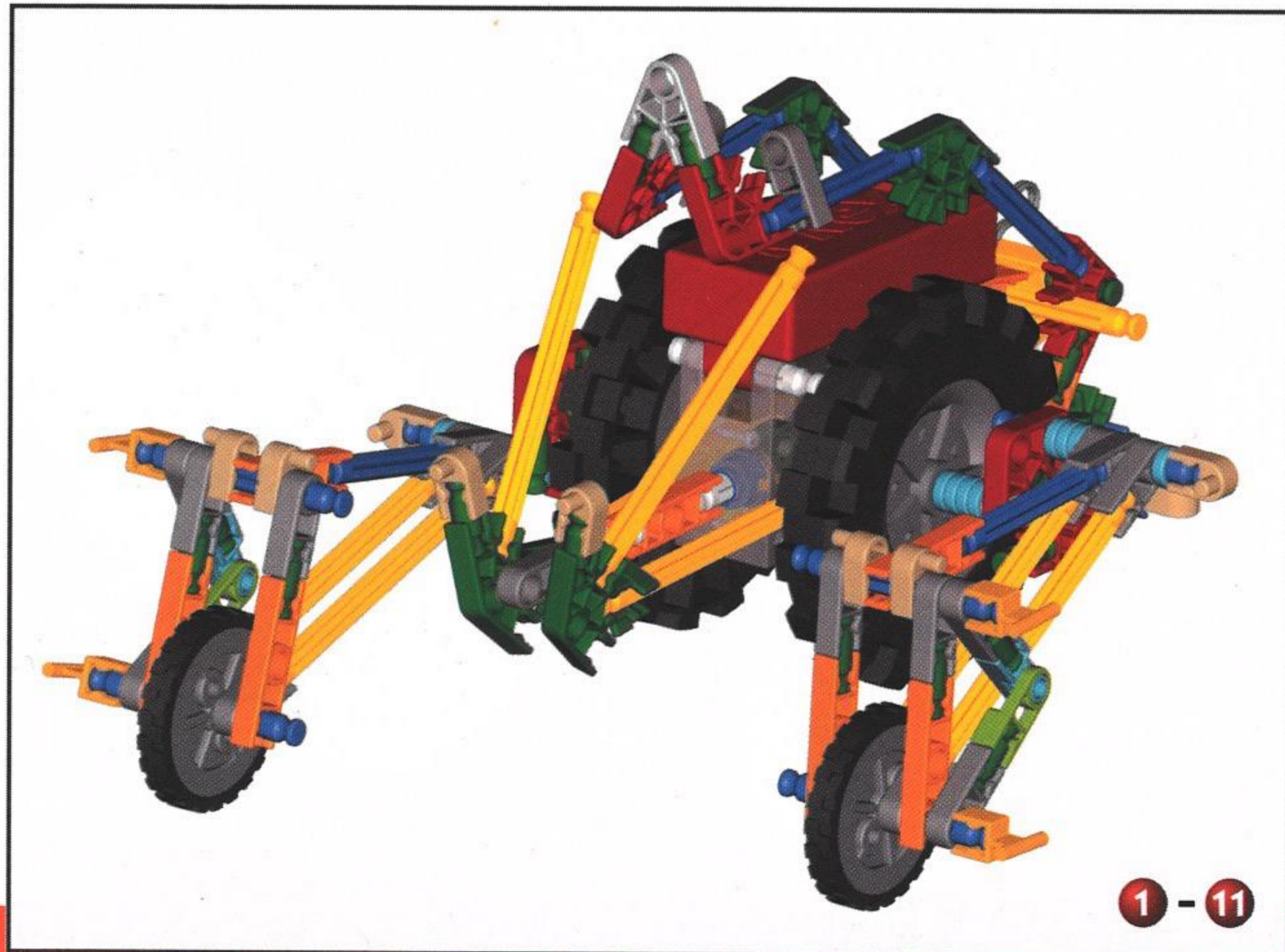
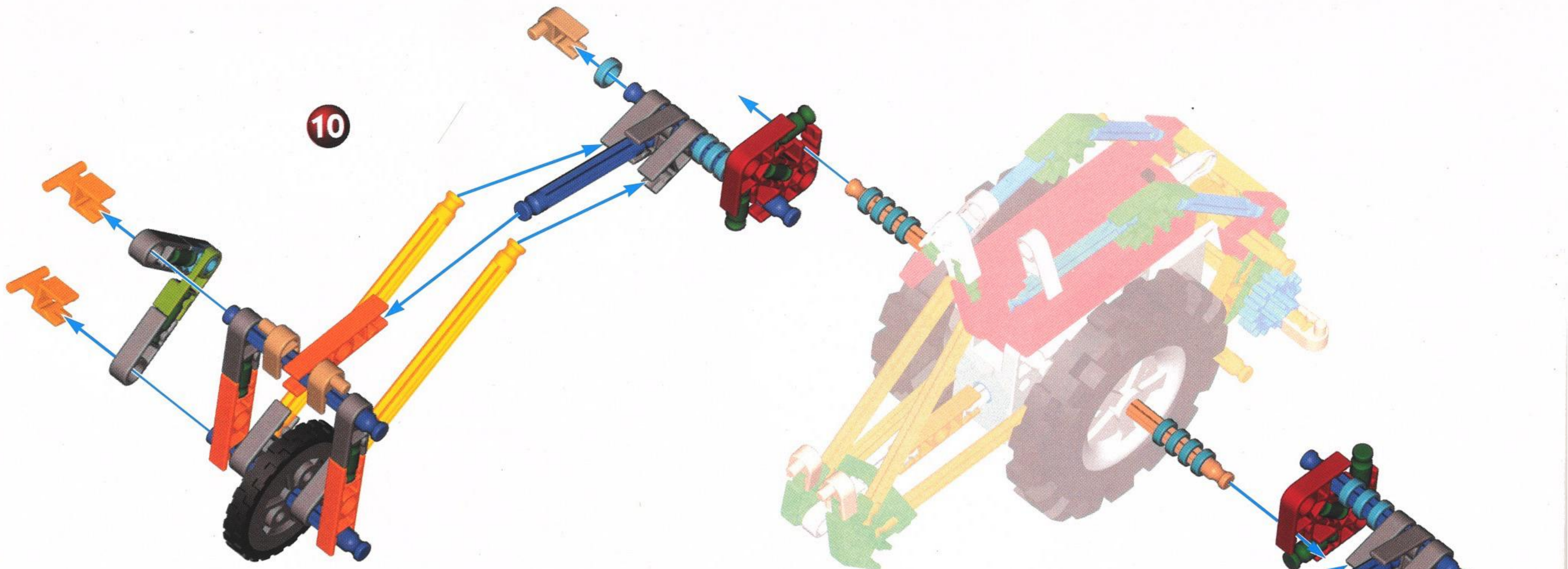

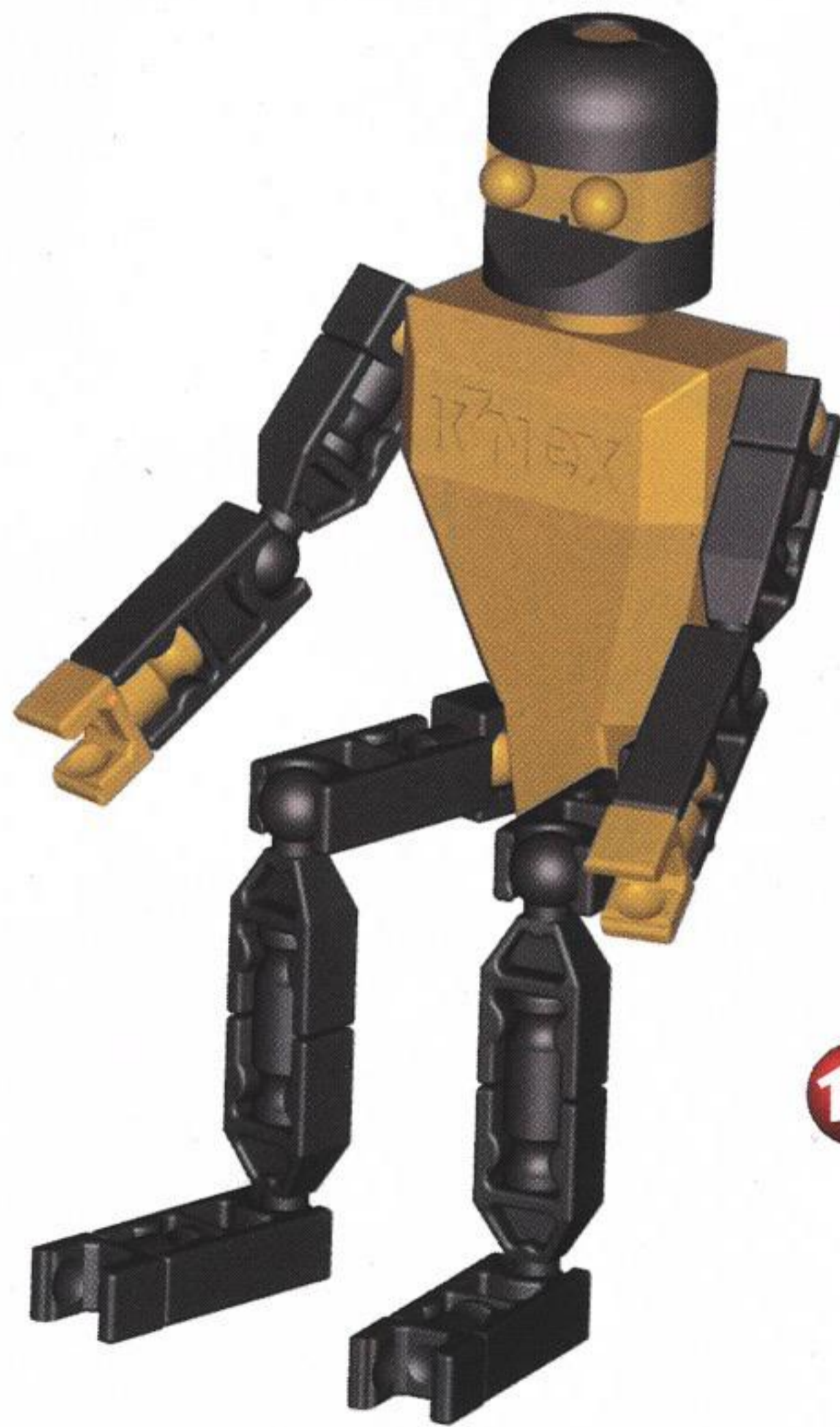
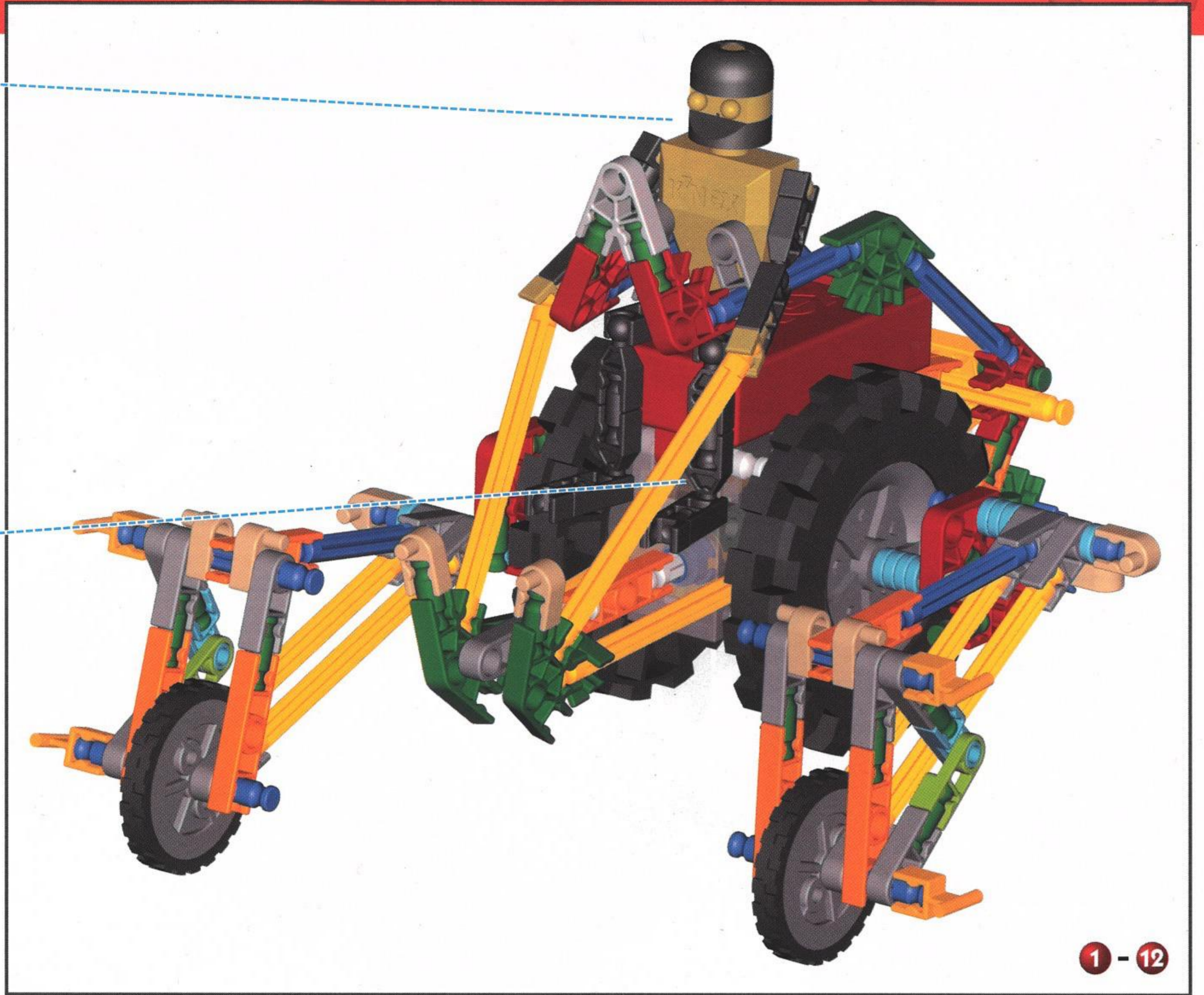
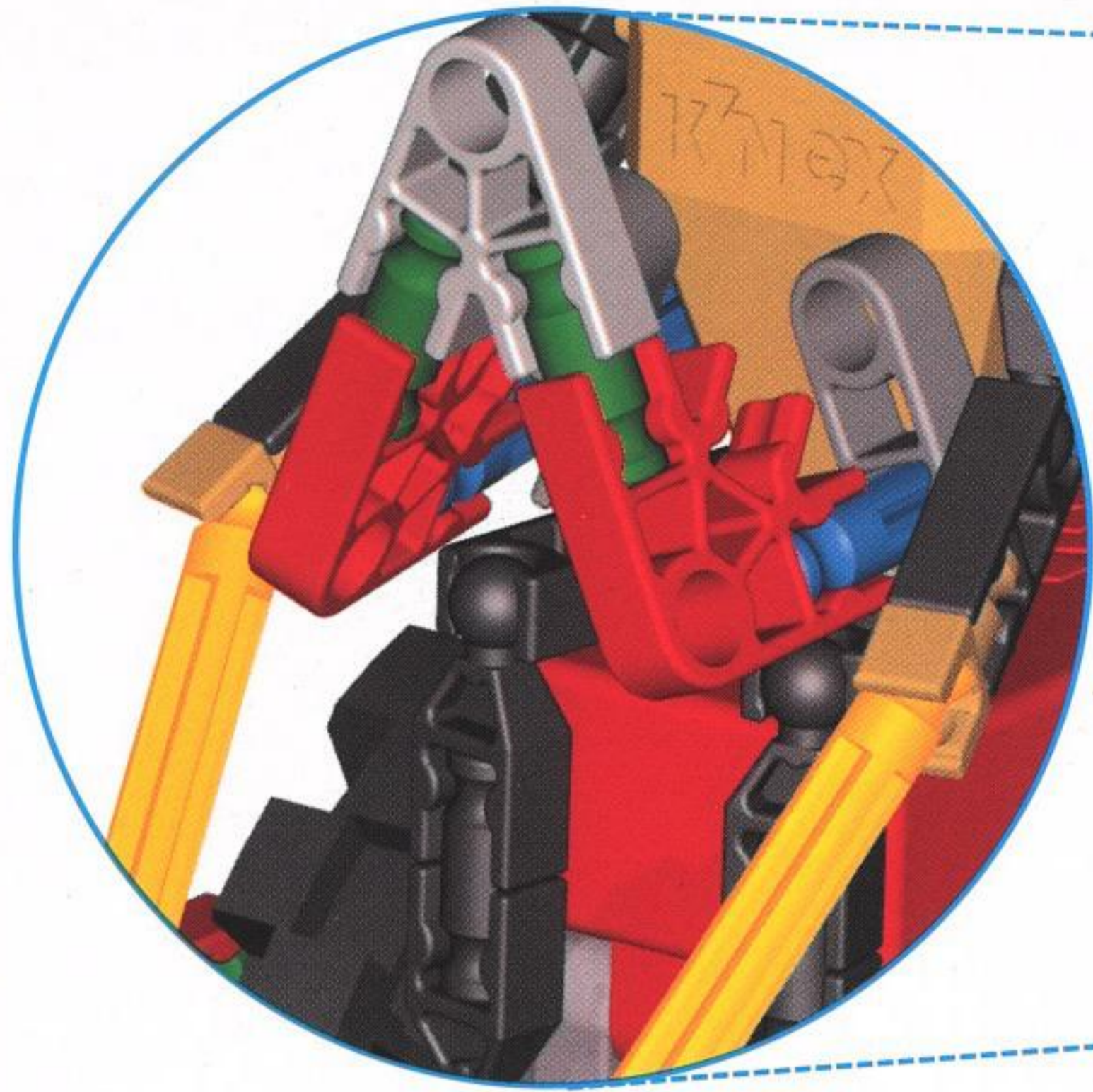

12

1 - 12

Creeper

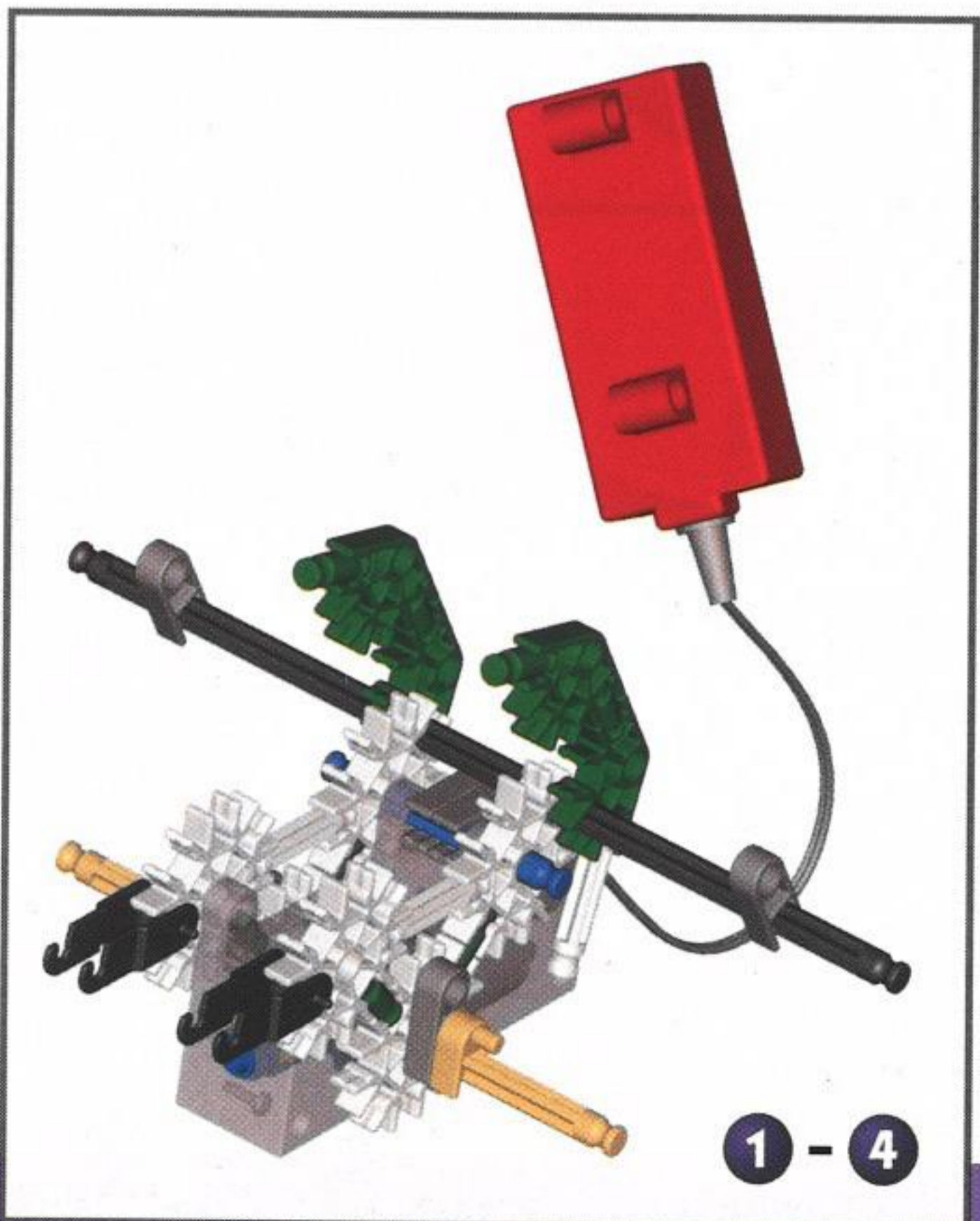
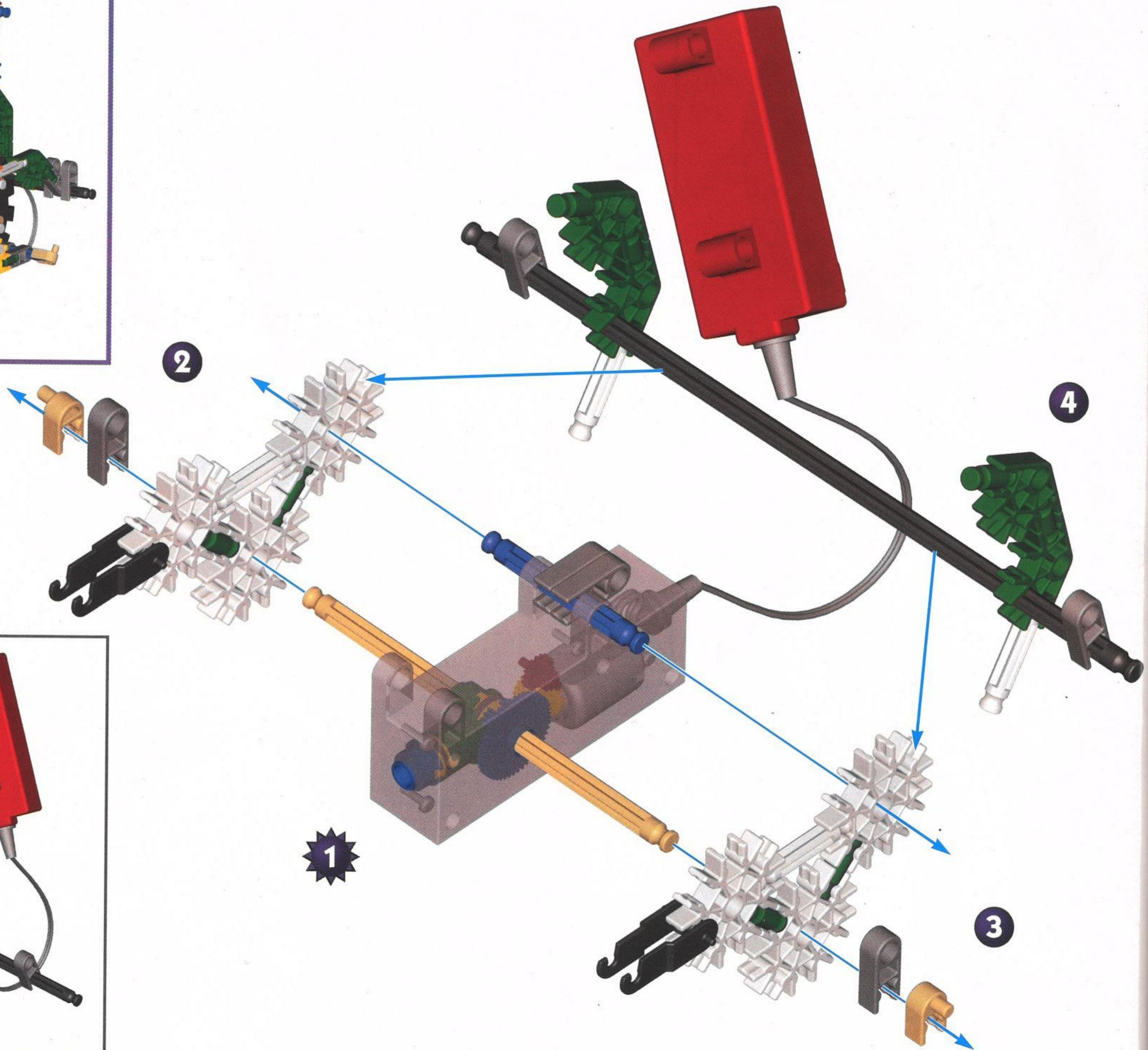

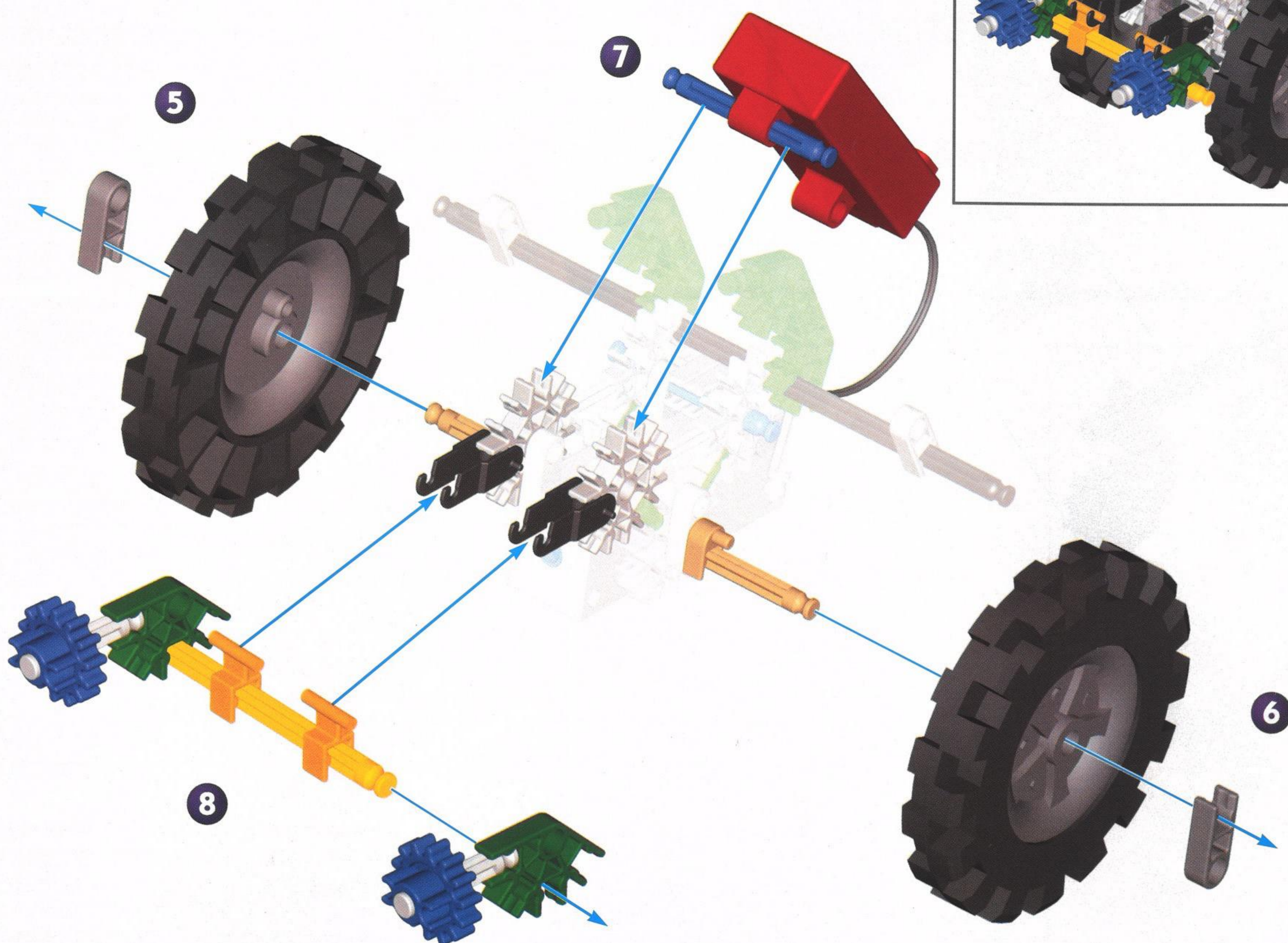

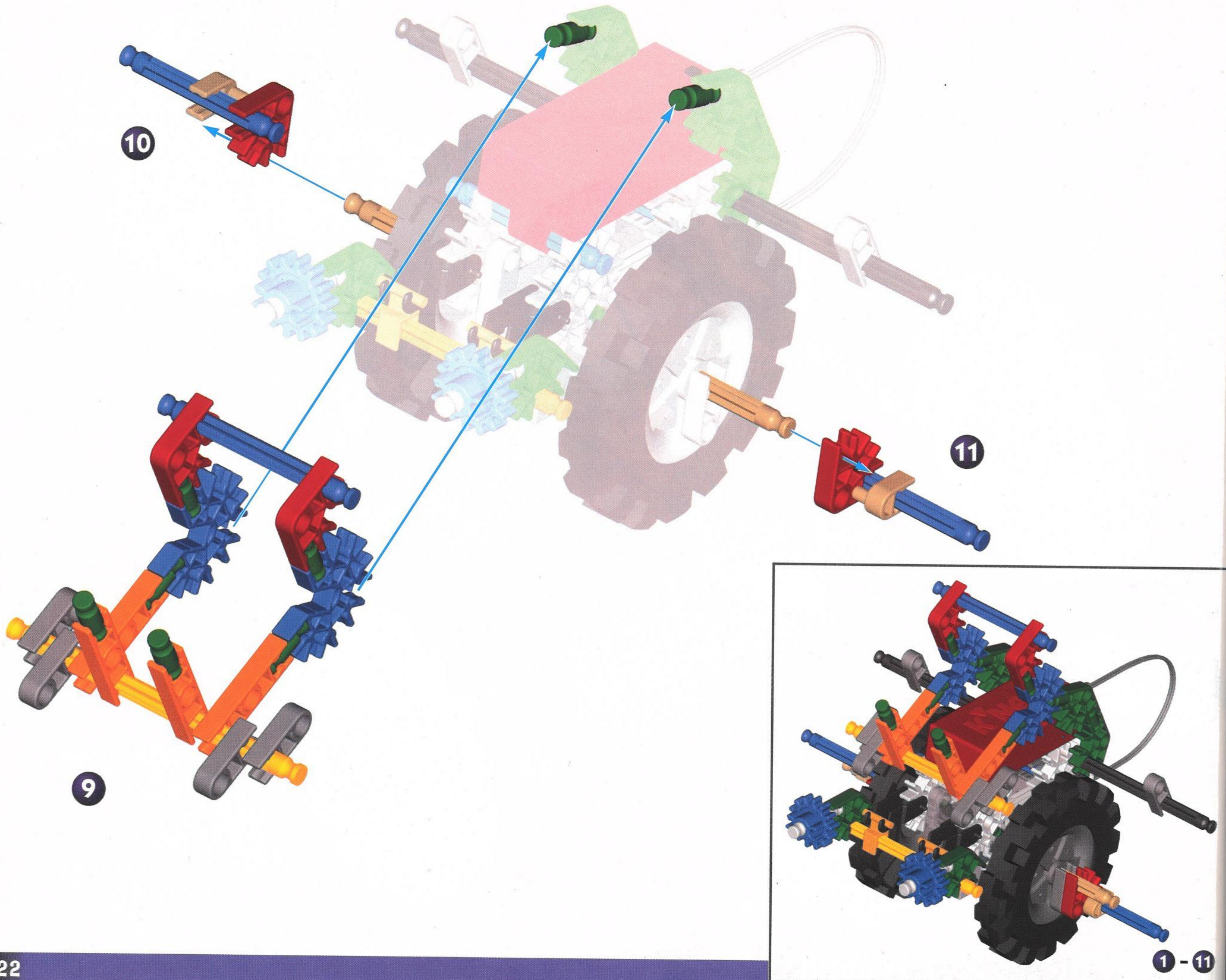



12

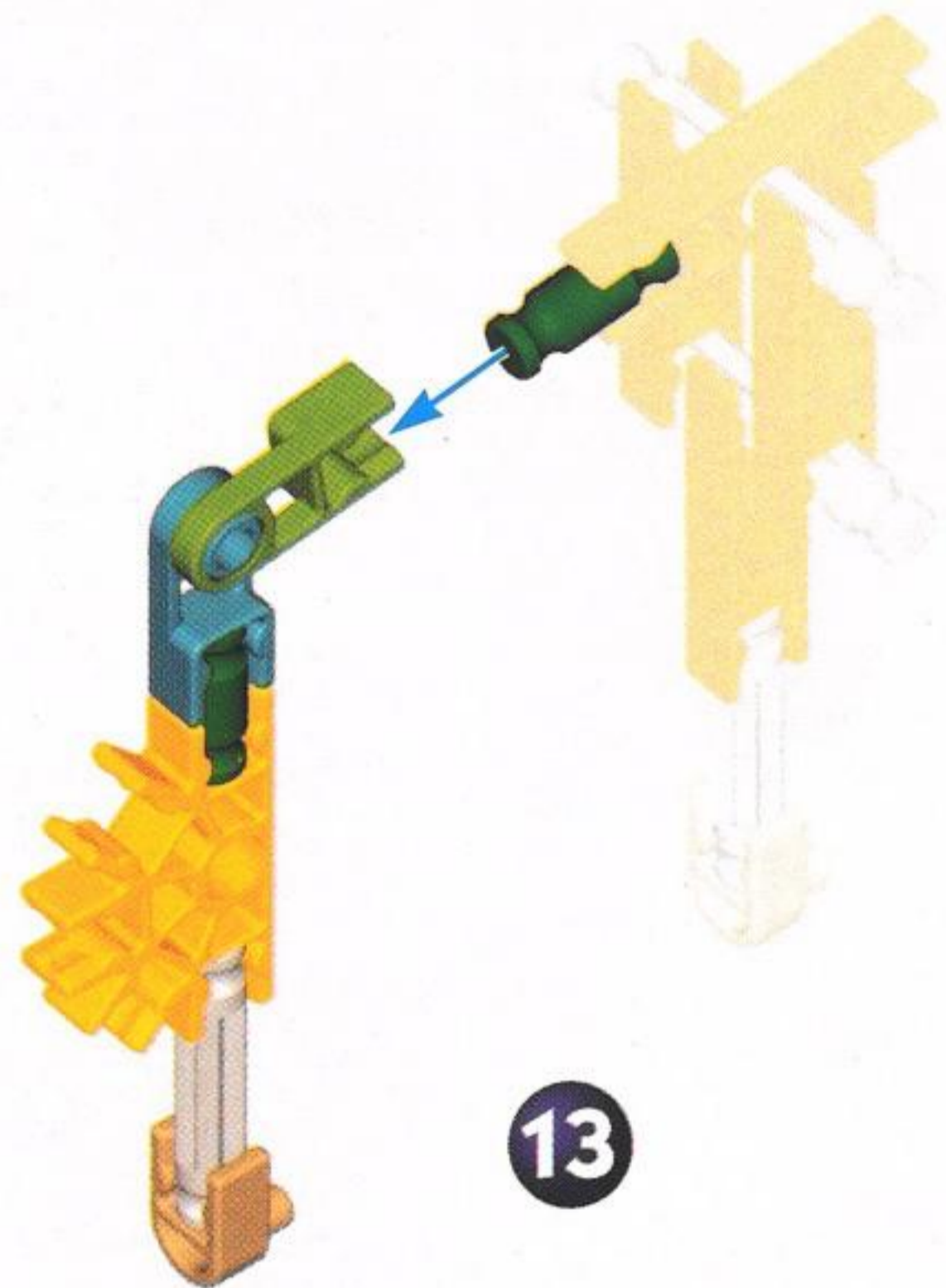

13

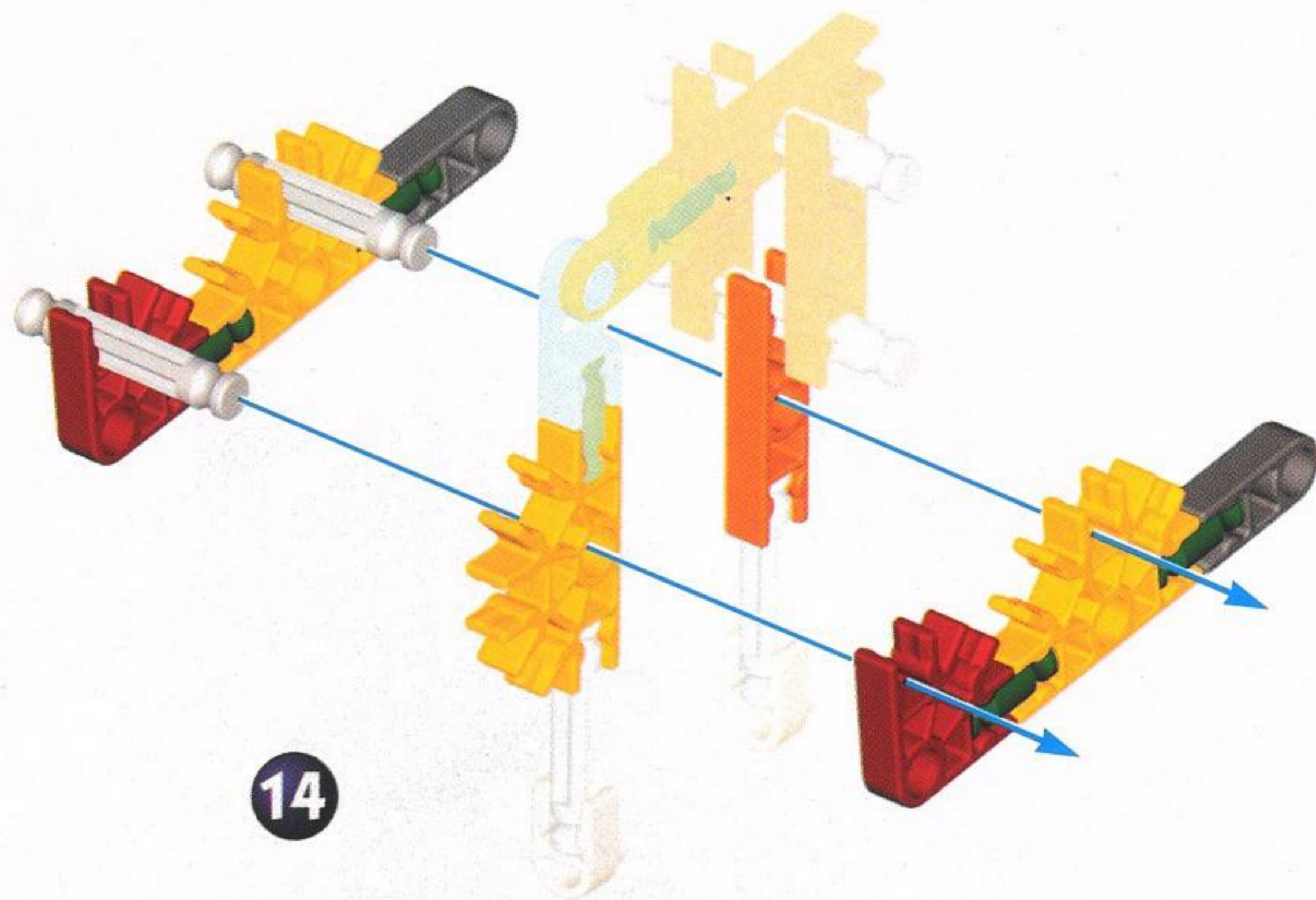

14

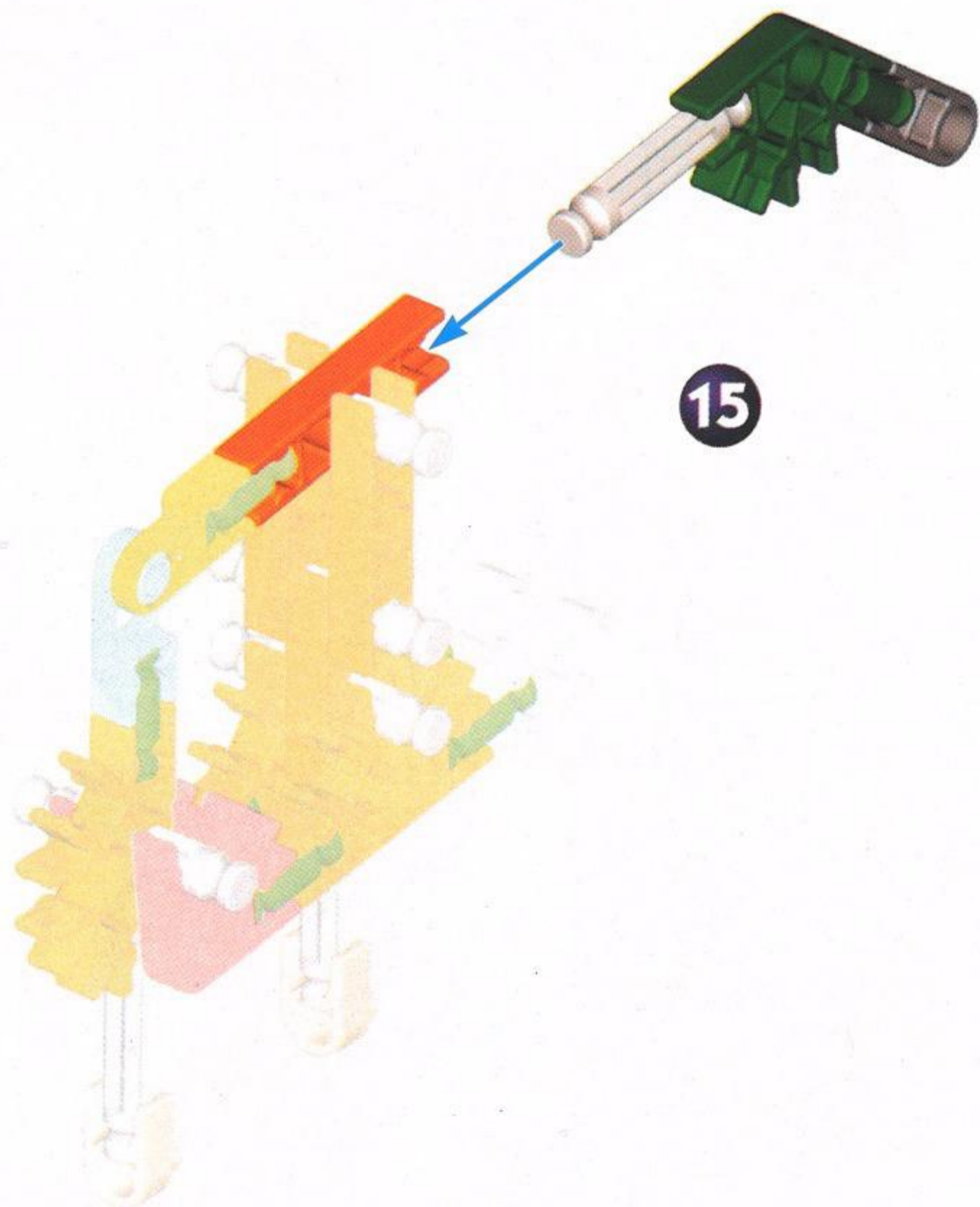

15

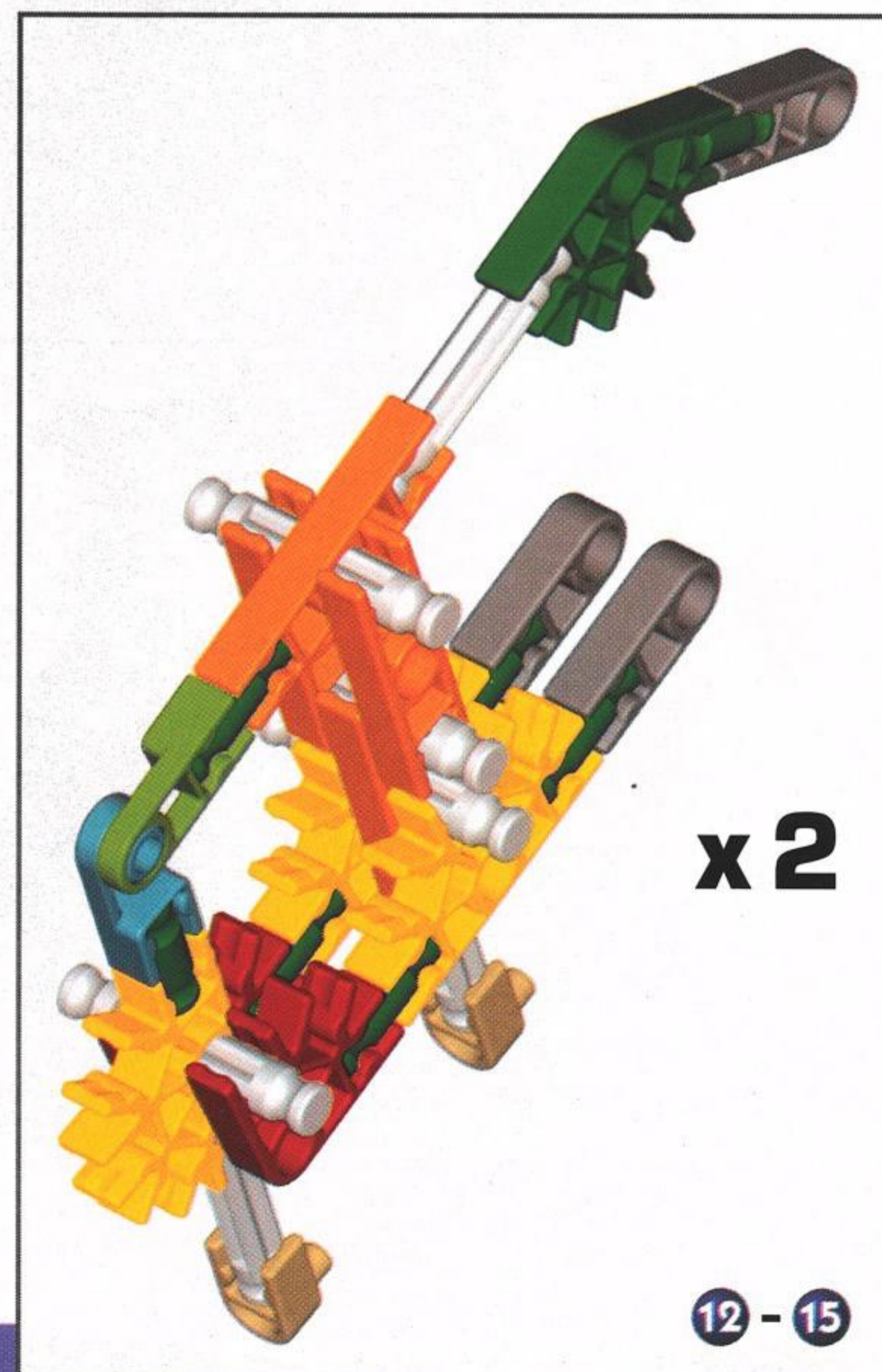

x 2

12 - 15

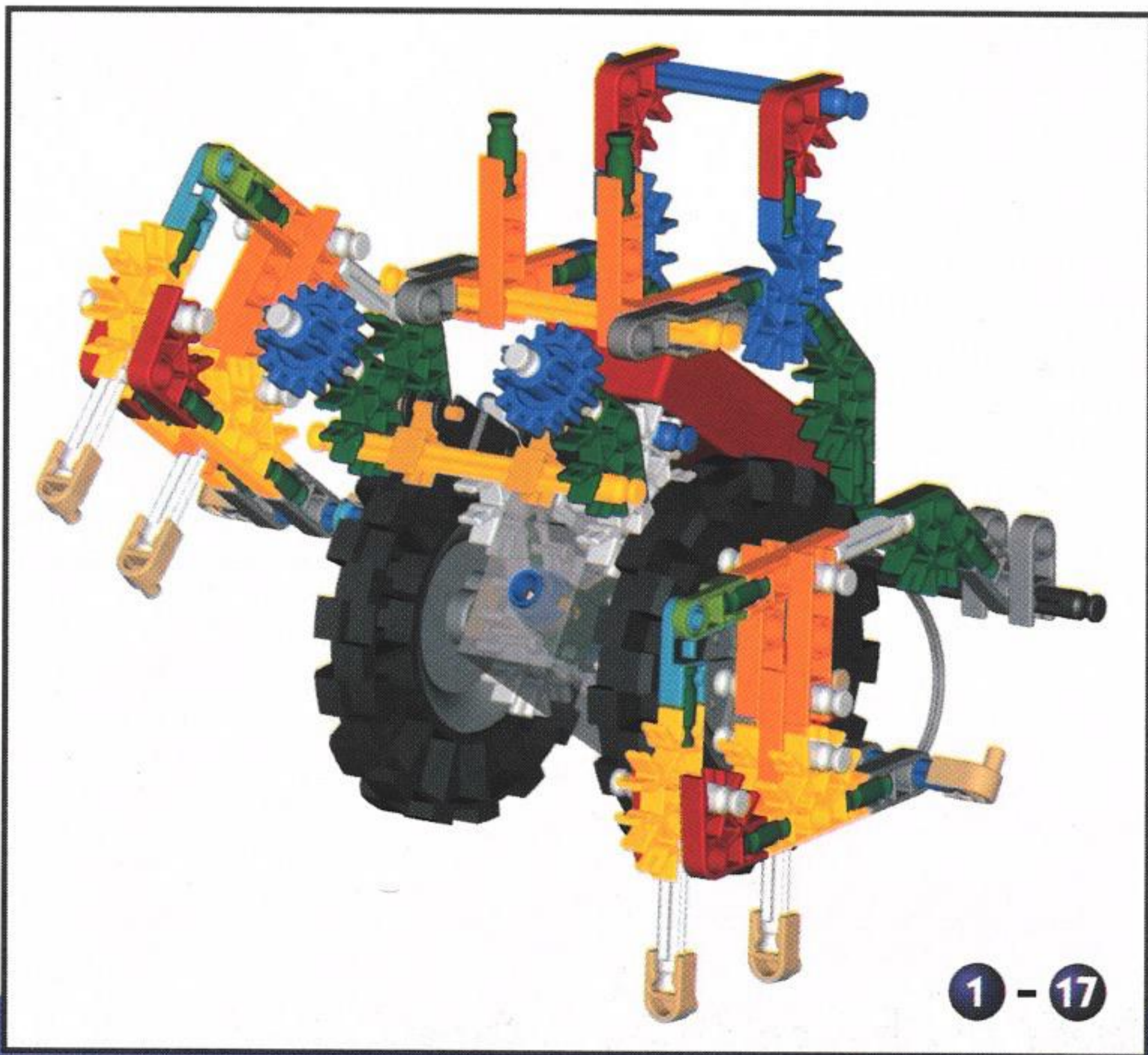
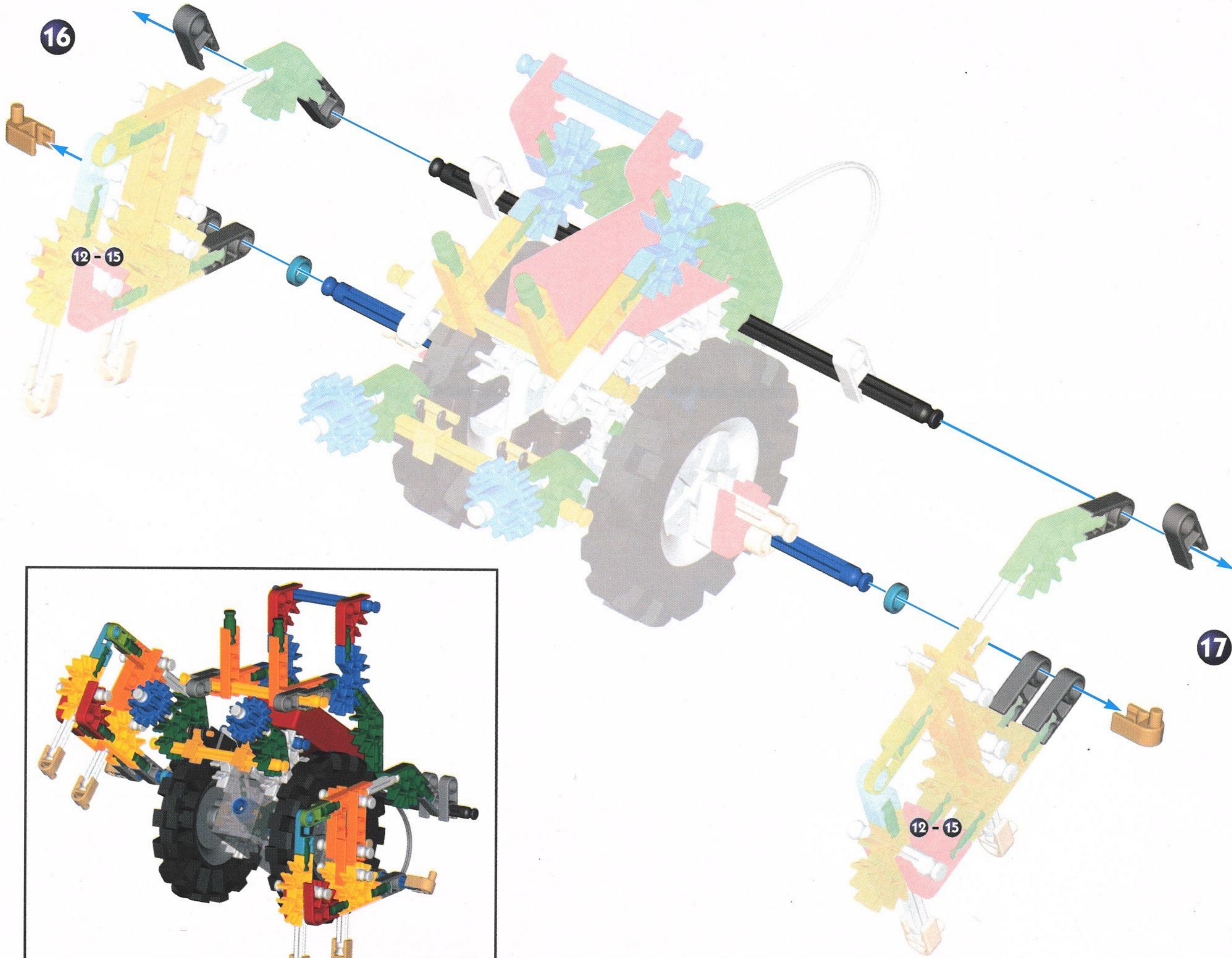

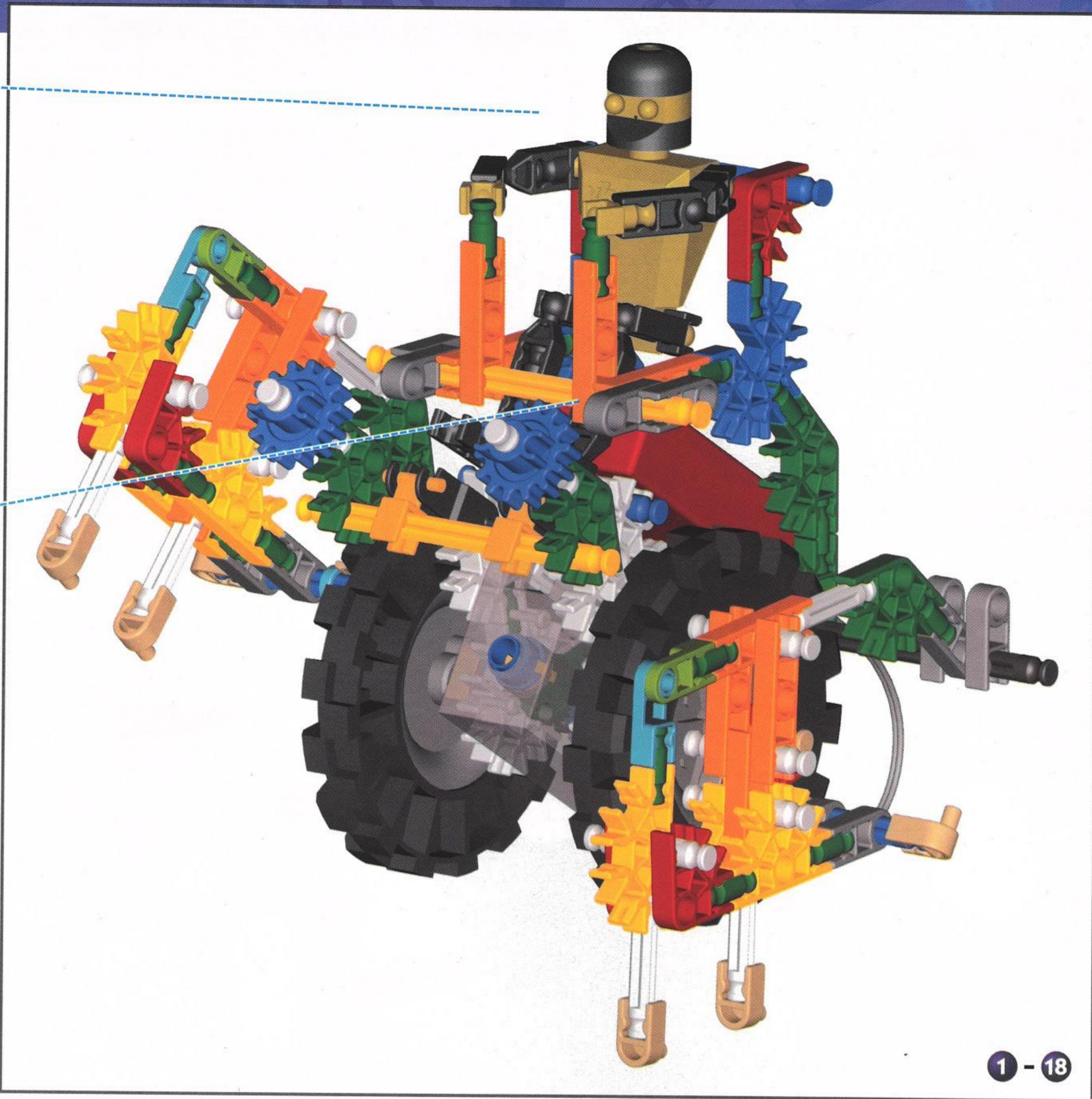
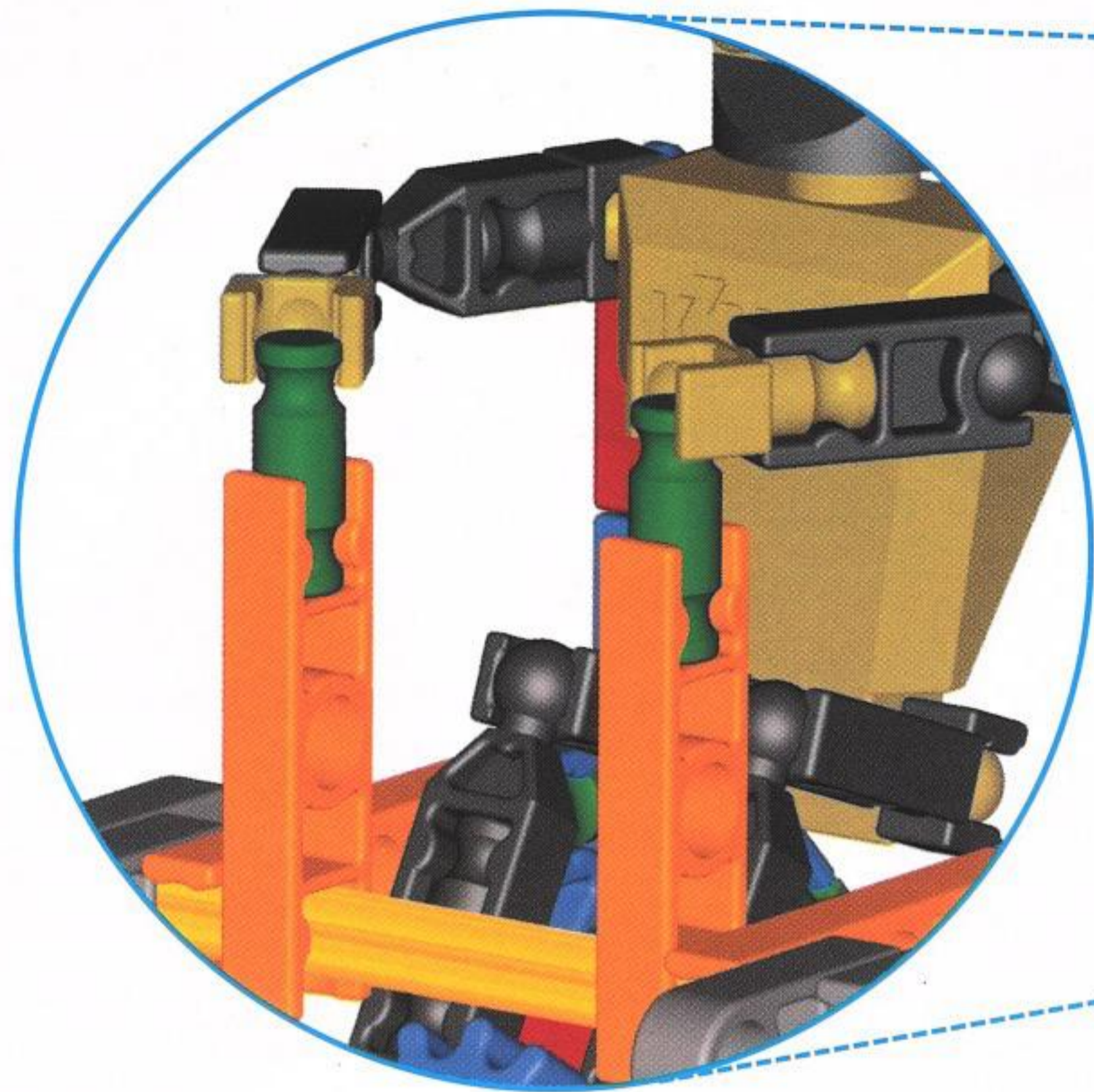

18

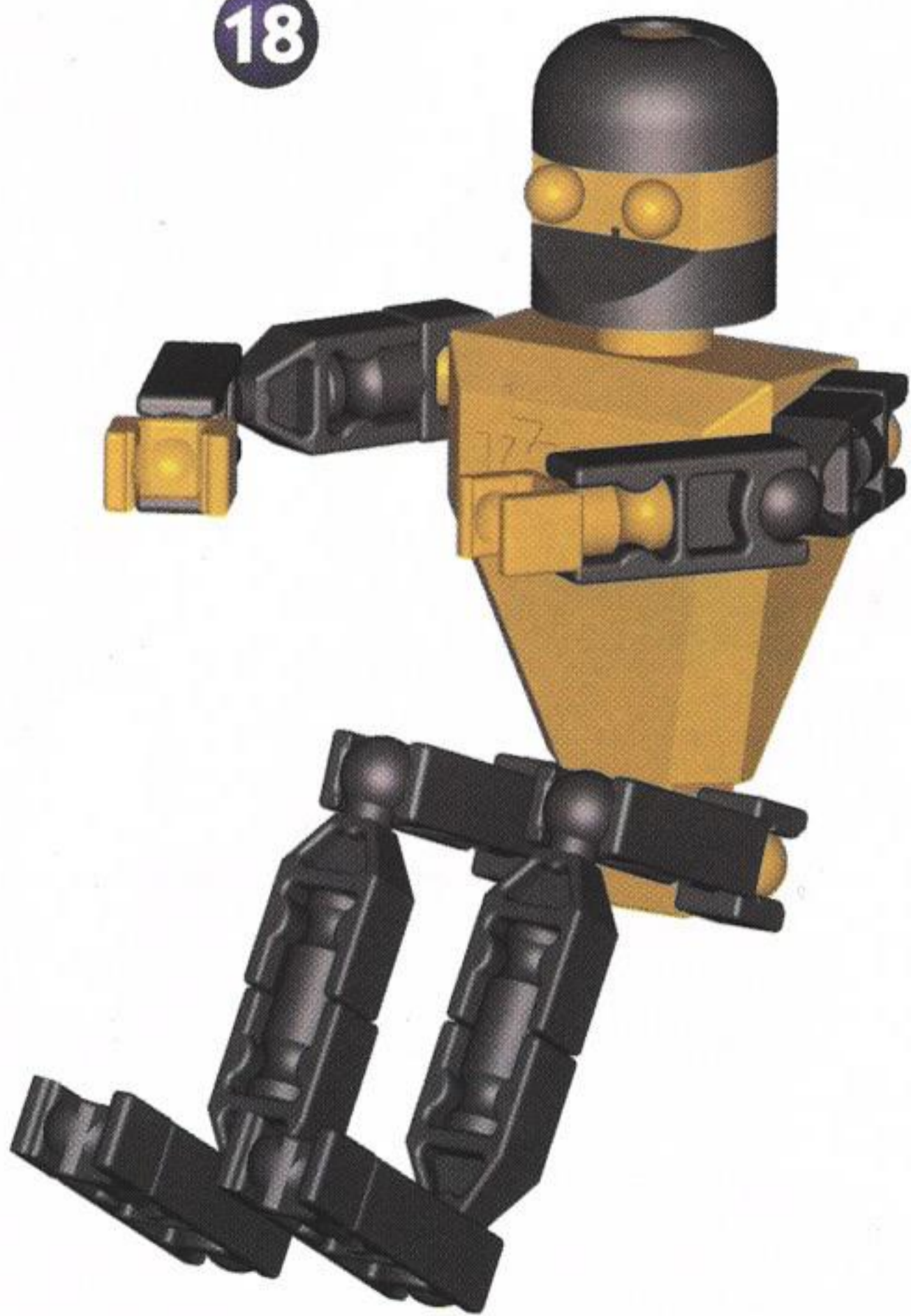

1 - 18

Grabber

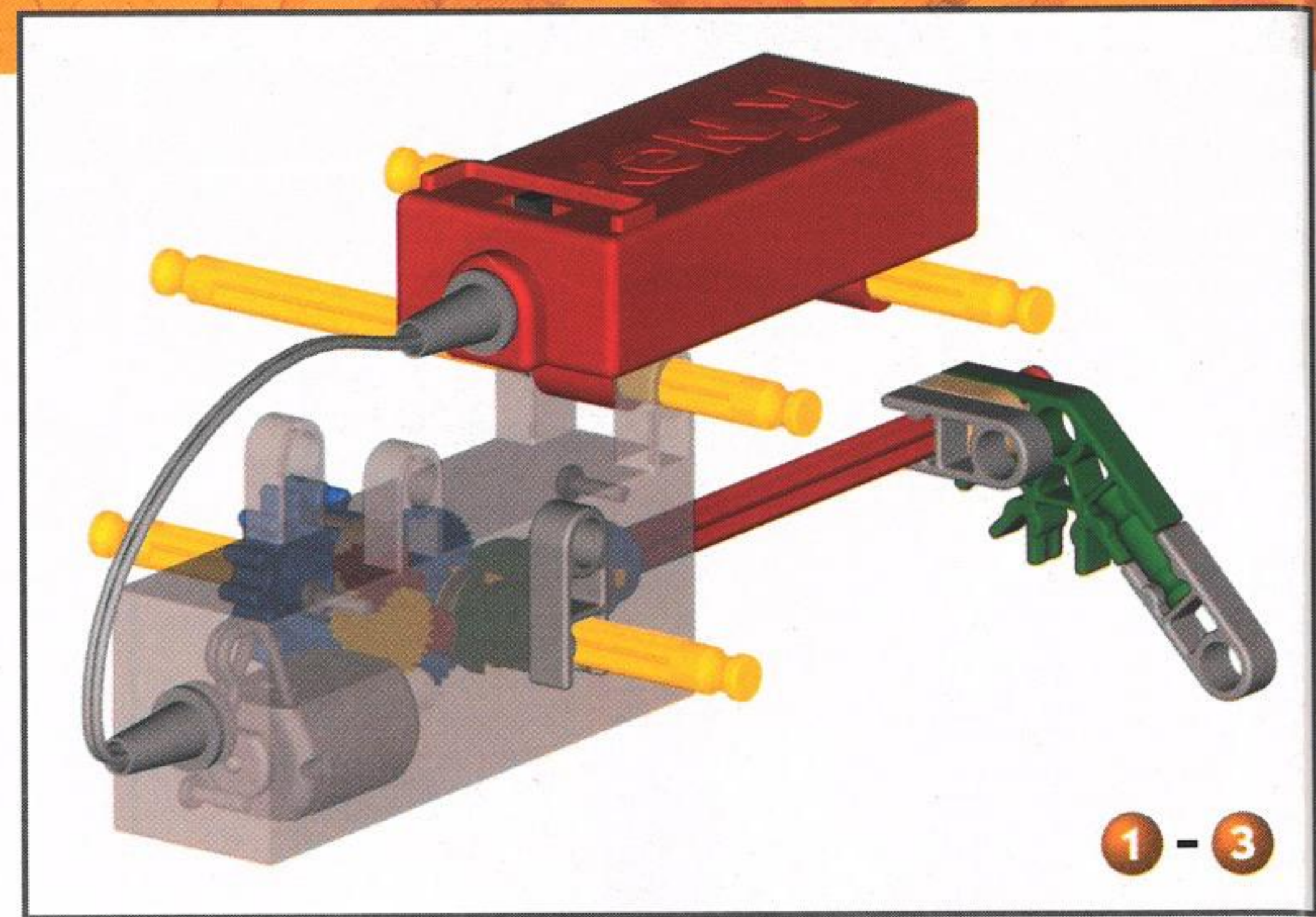
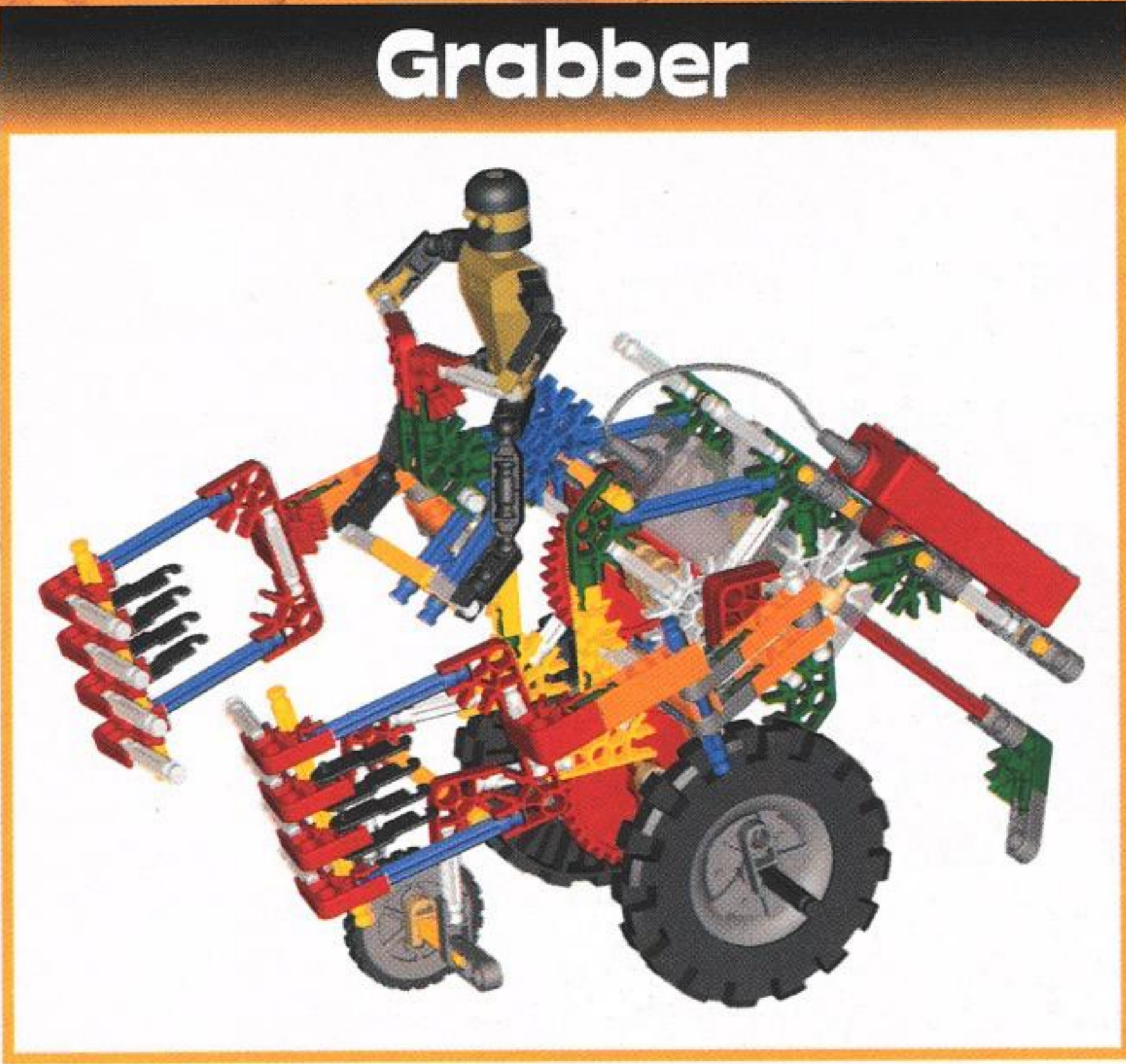

1 - 3

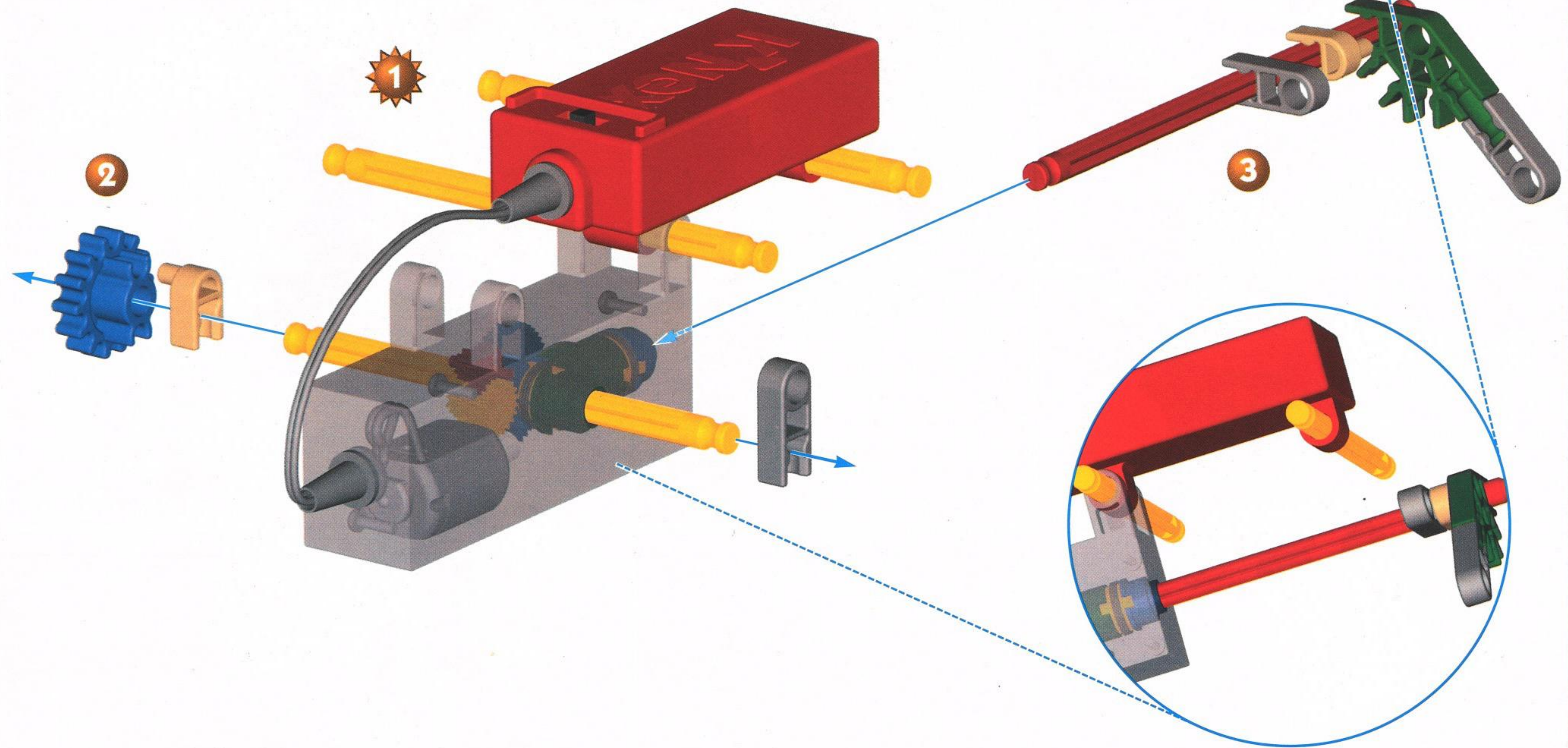

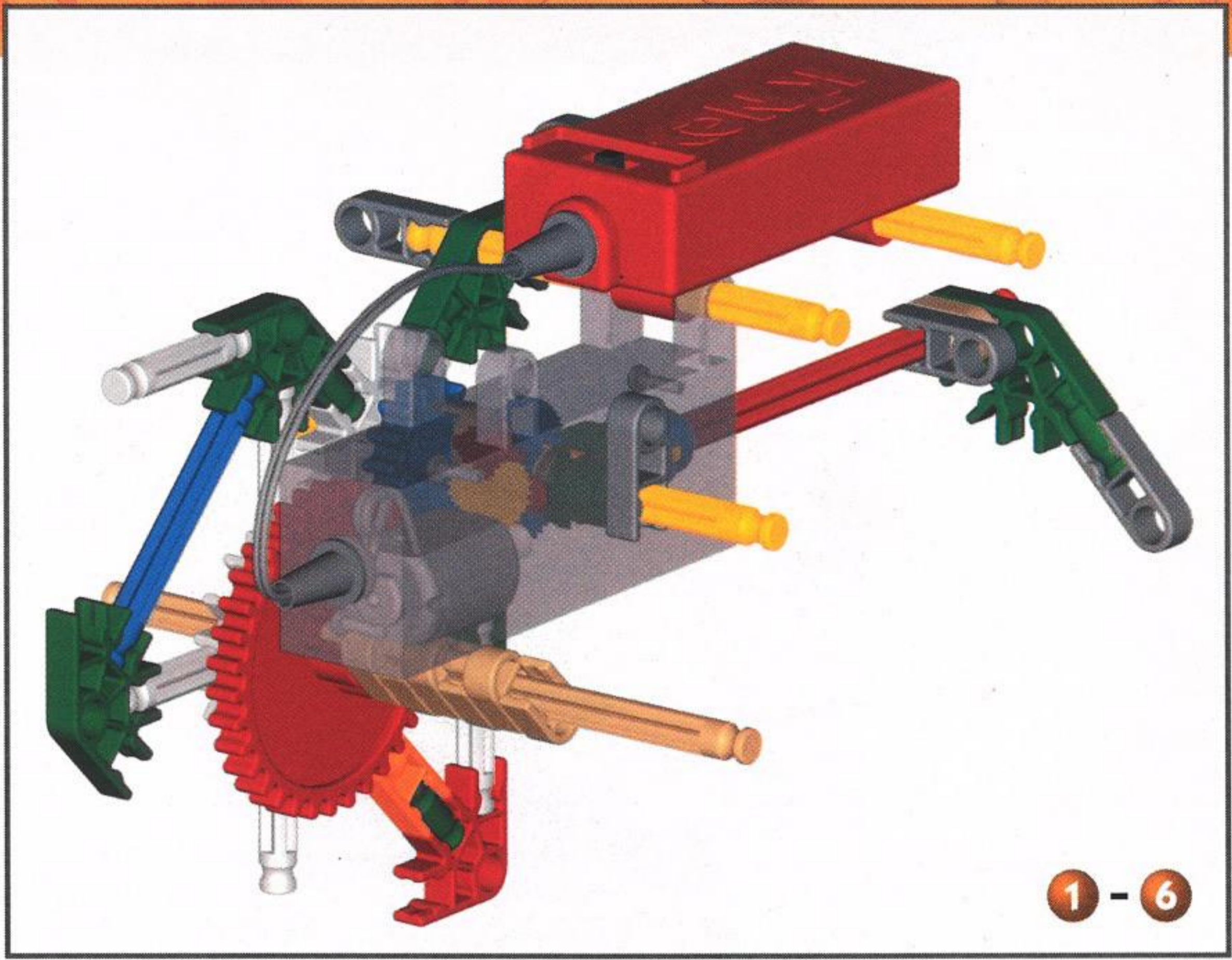

1 - 6

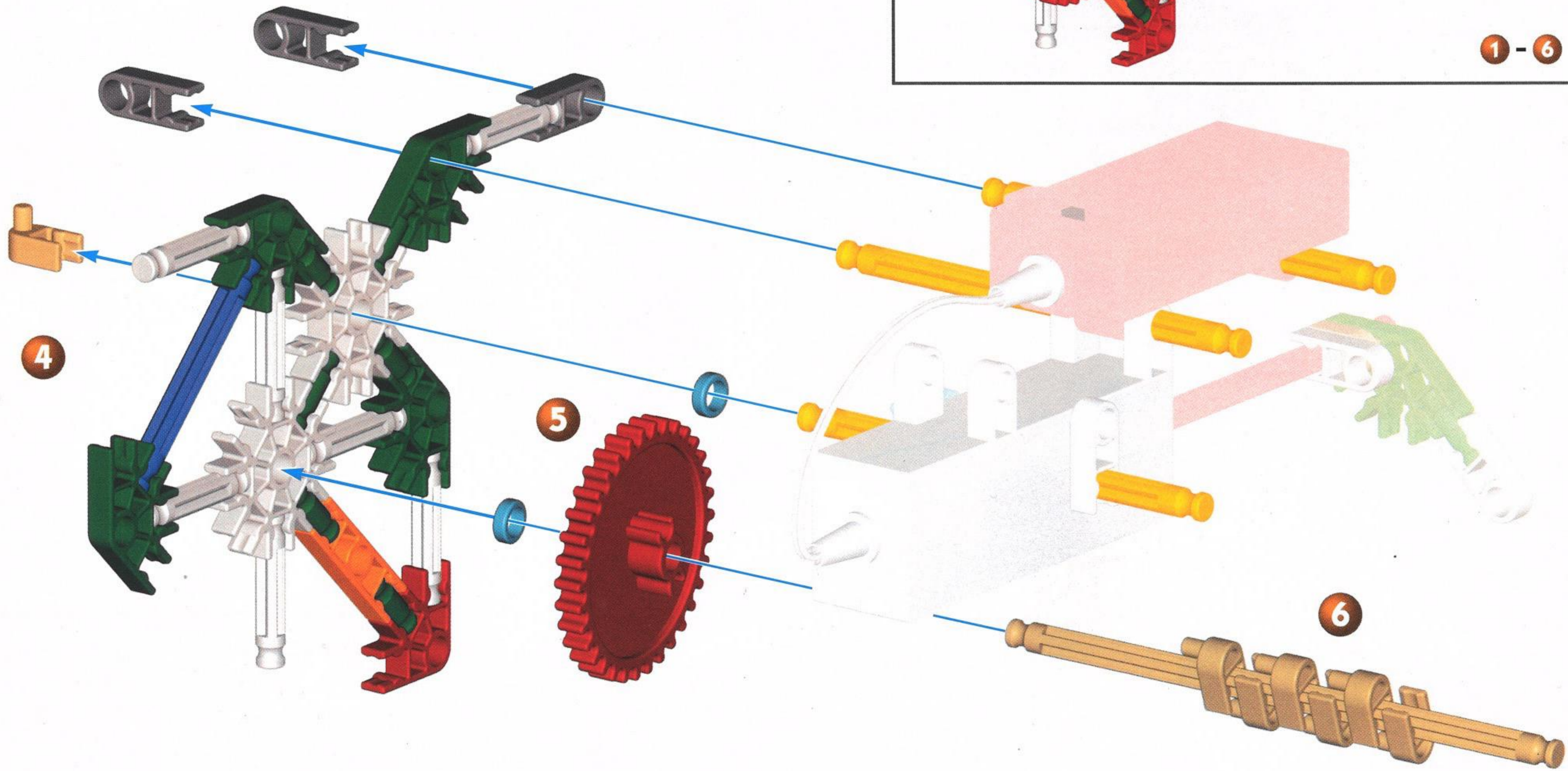

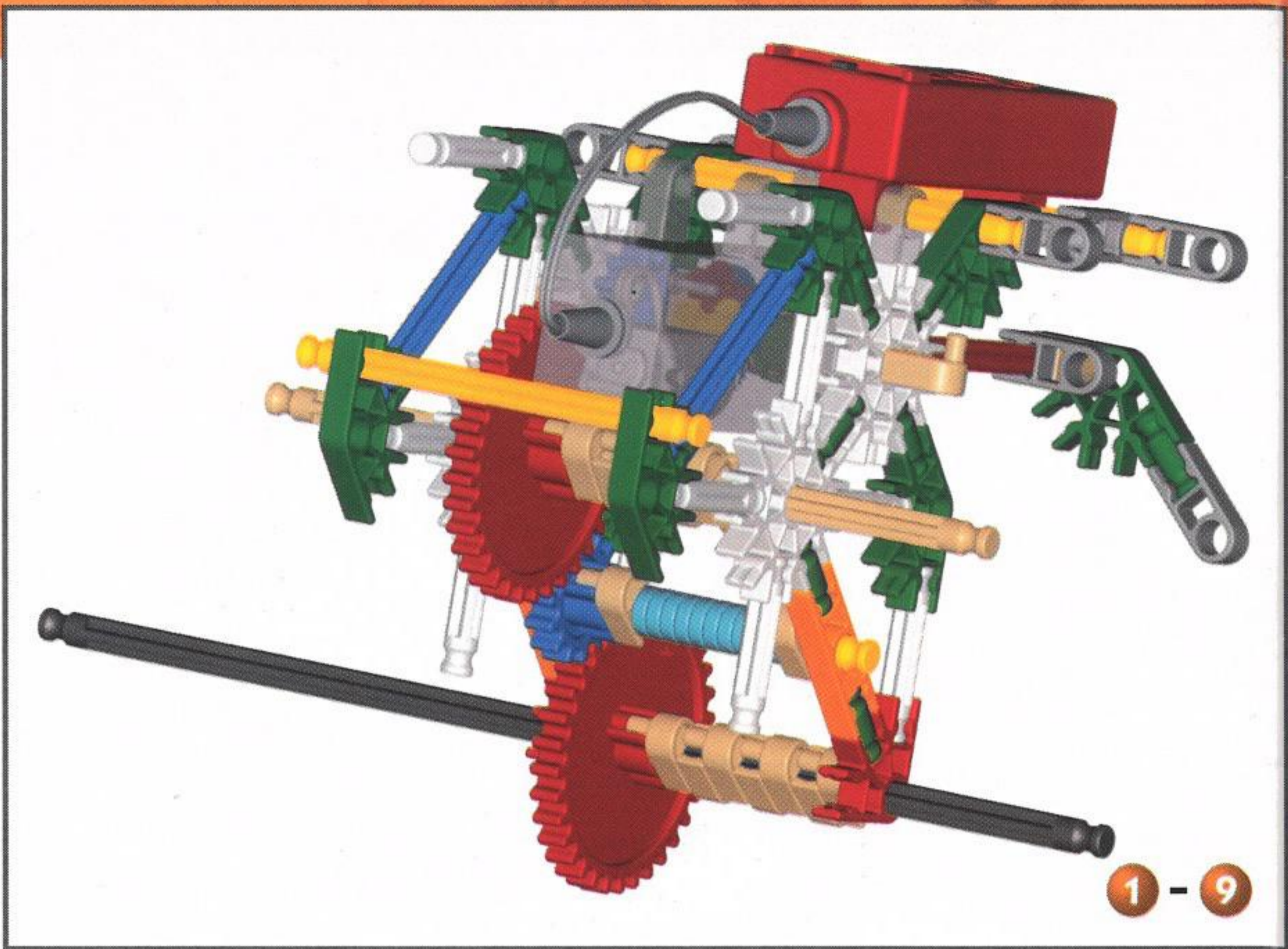
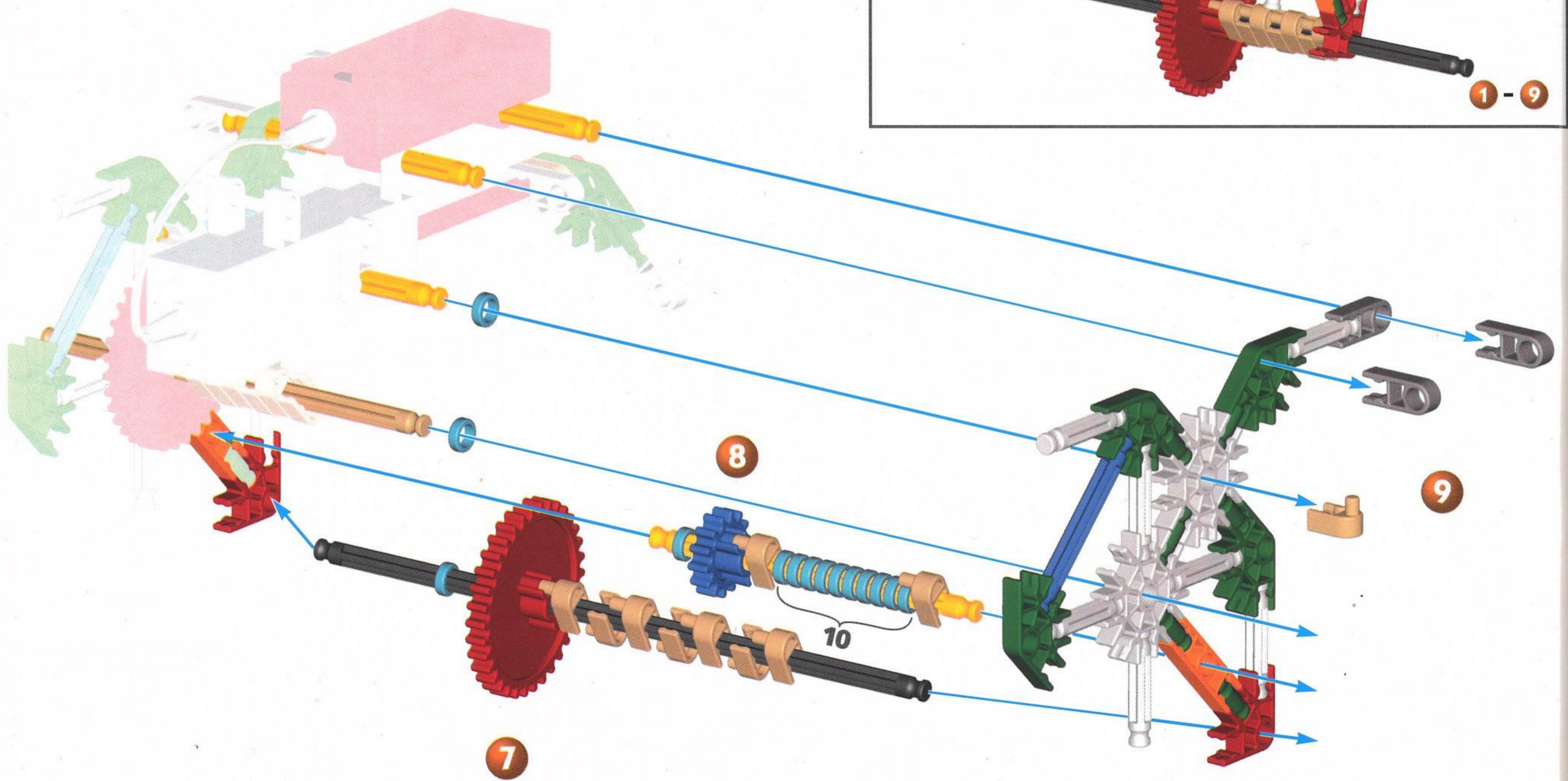

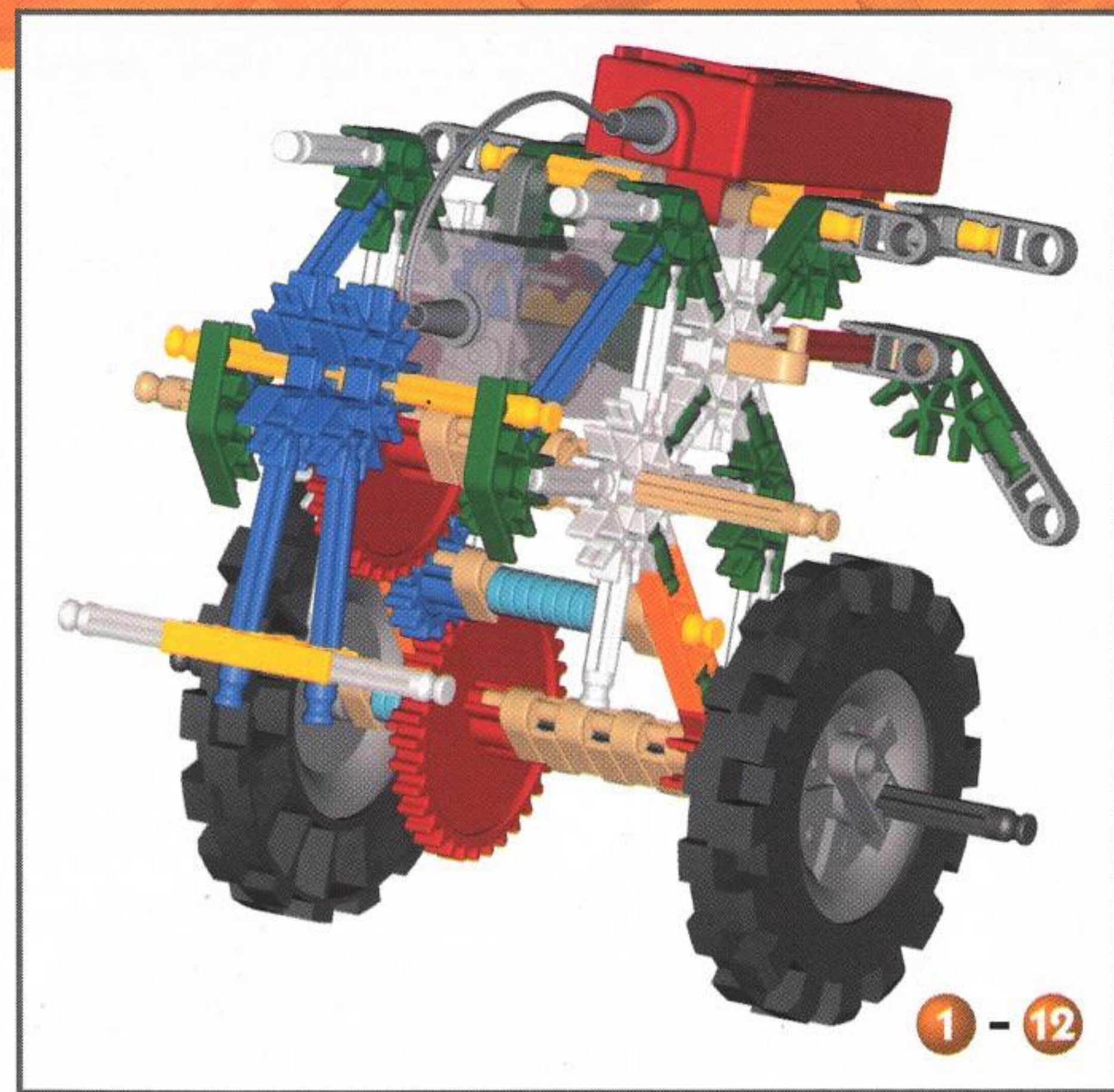
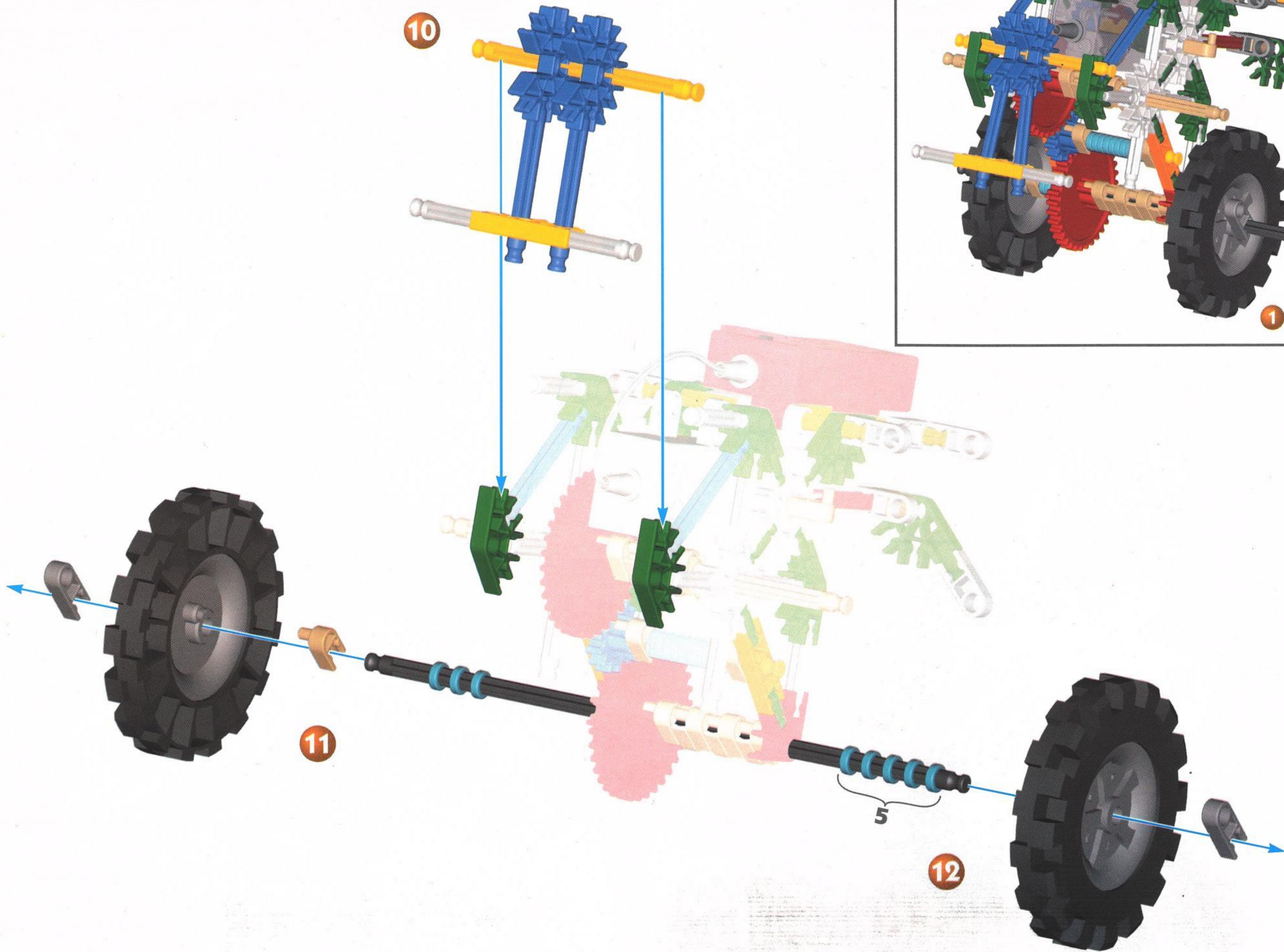

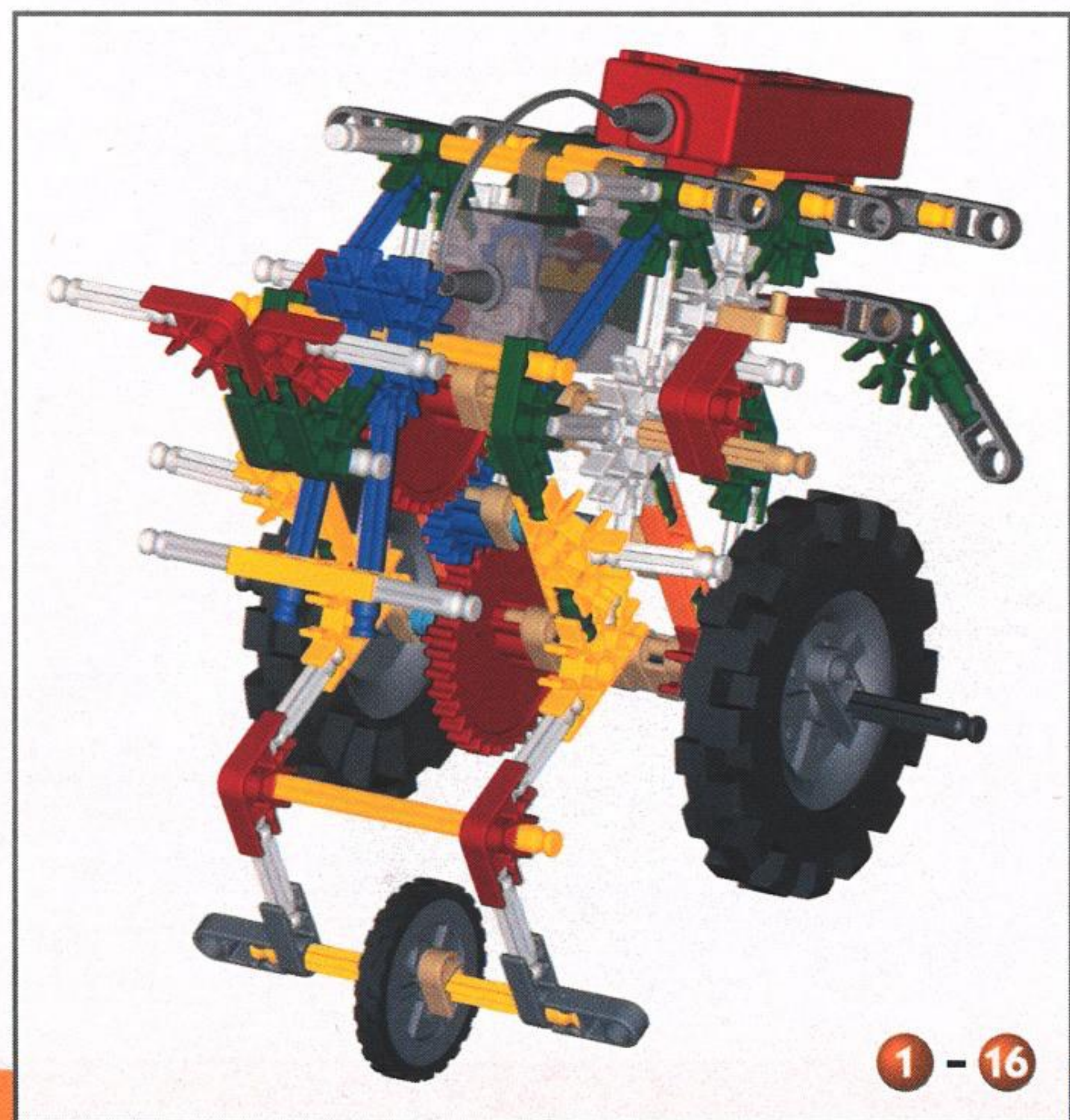
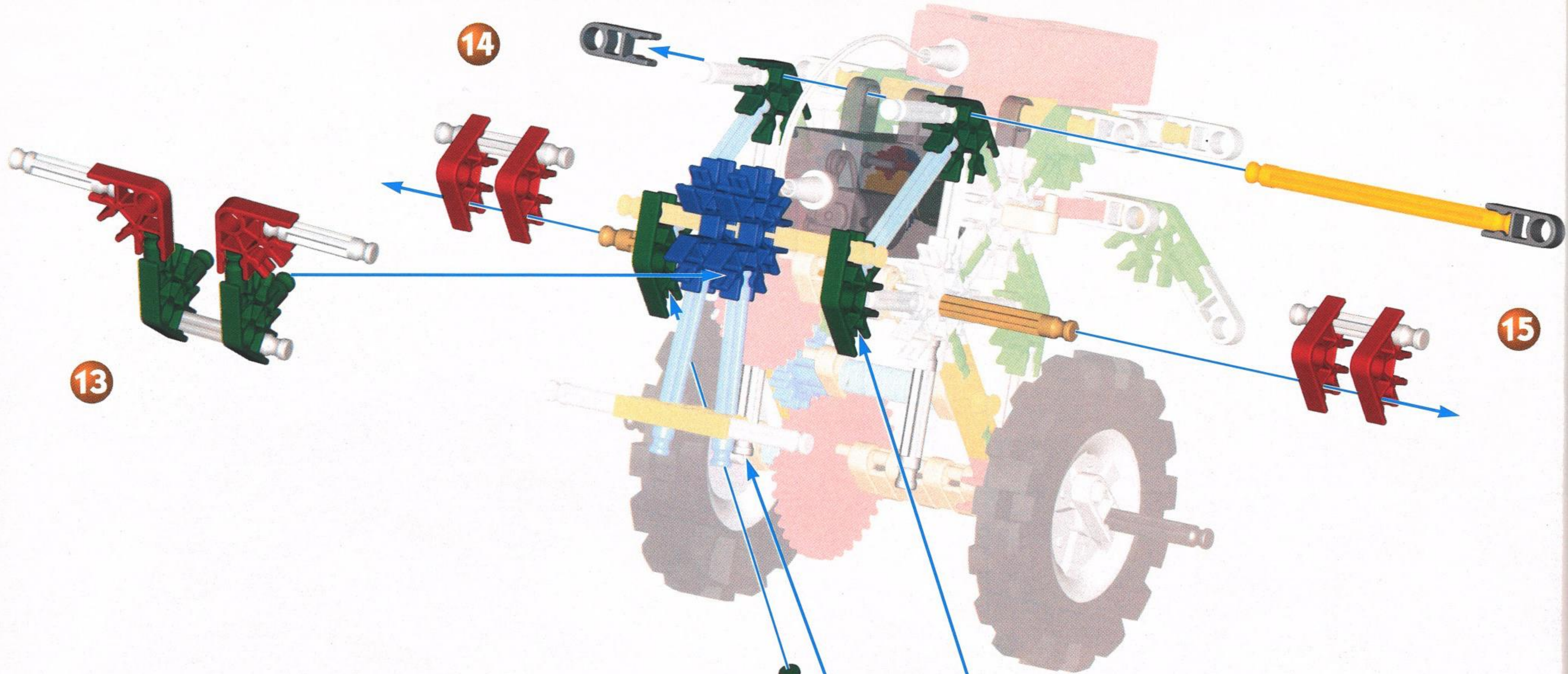

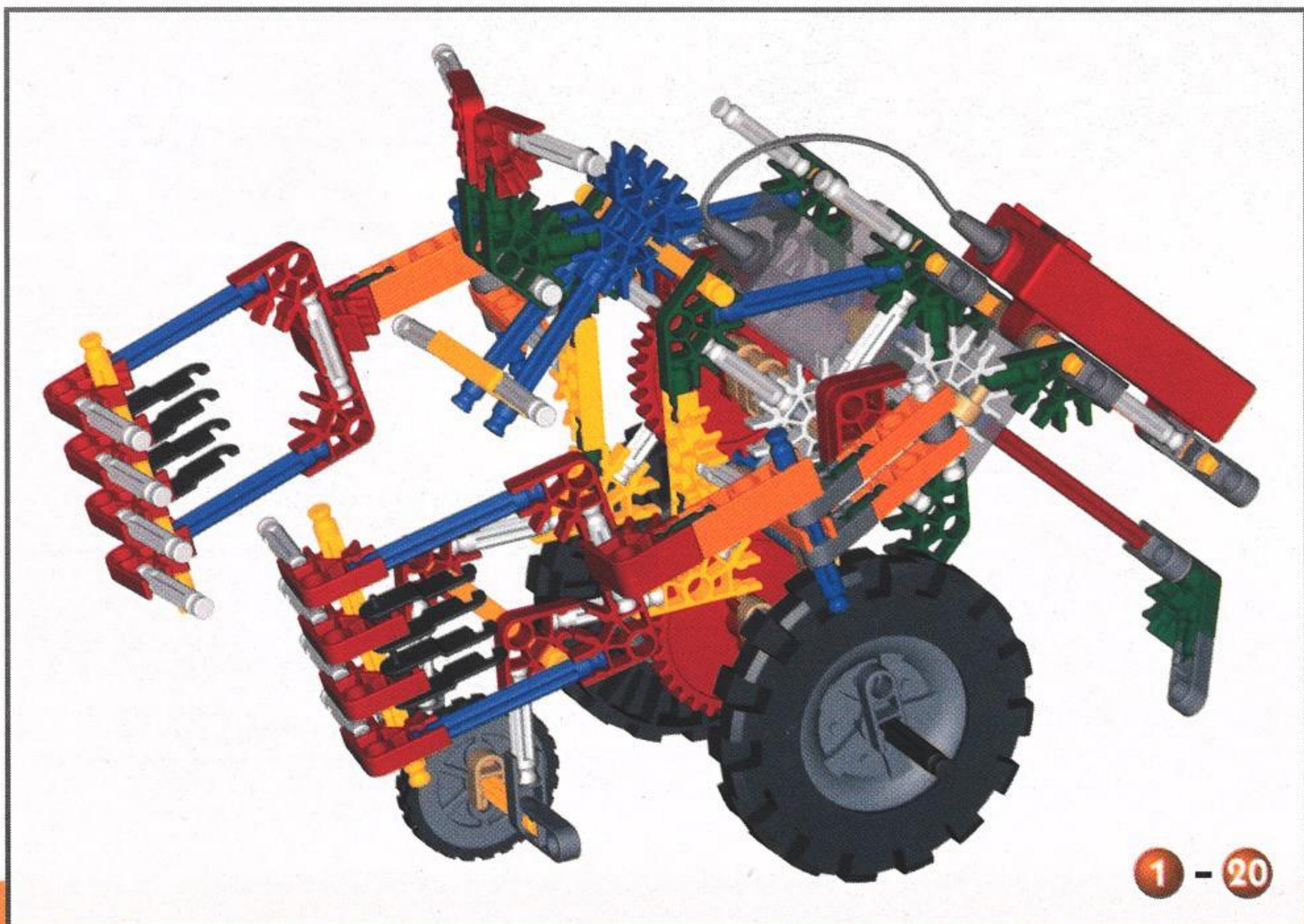
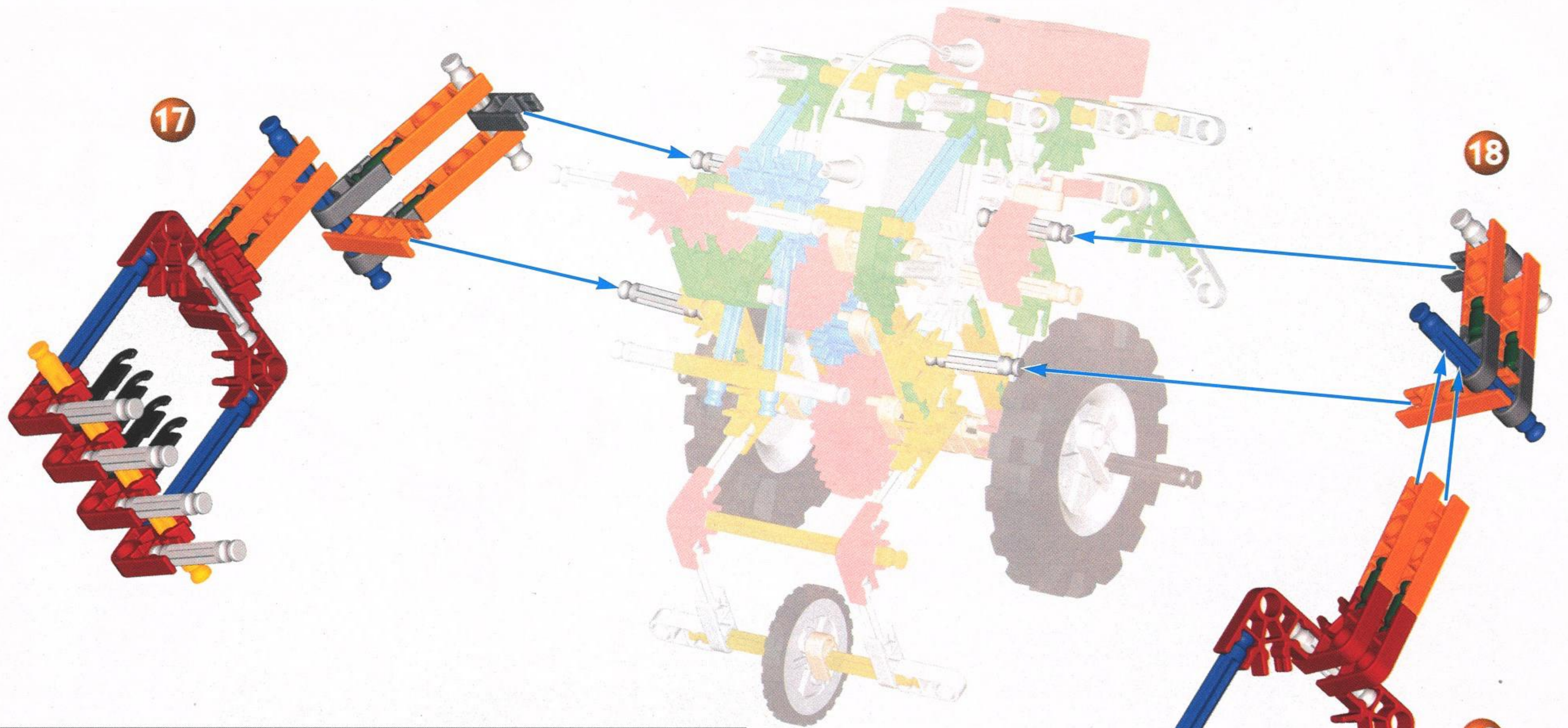

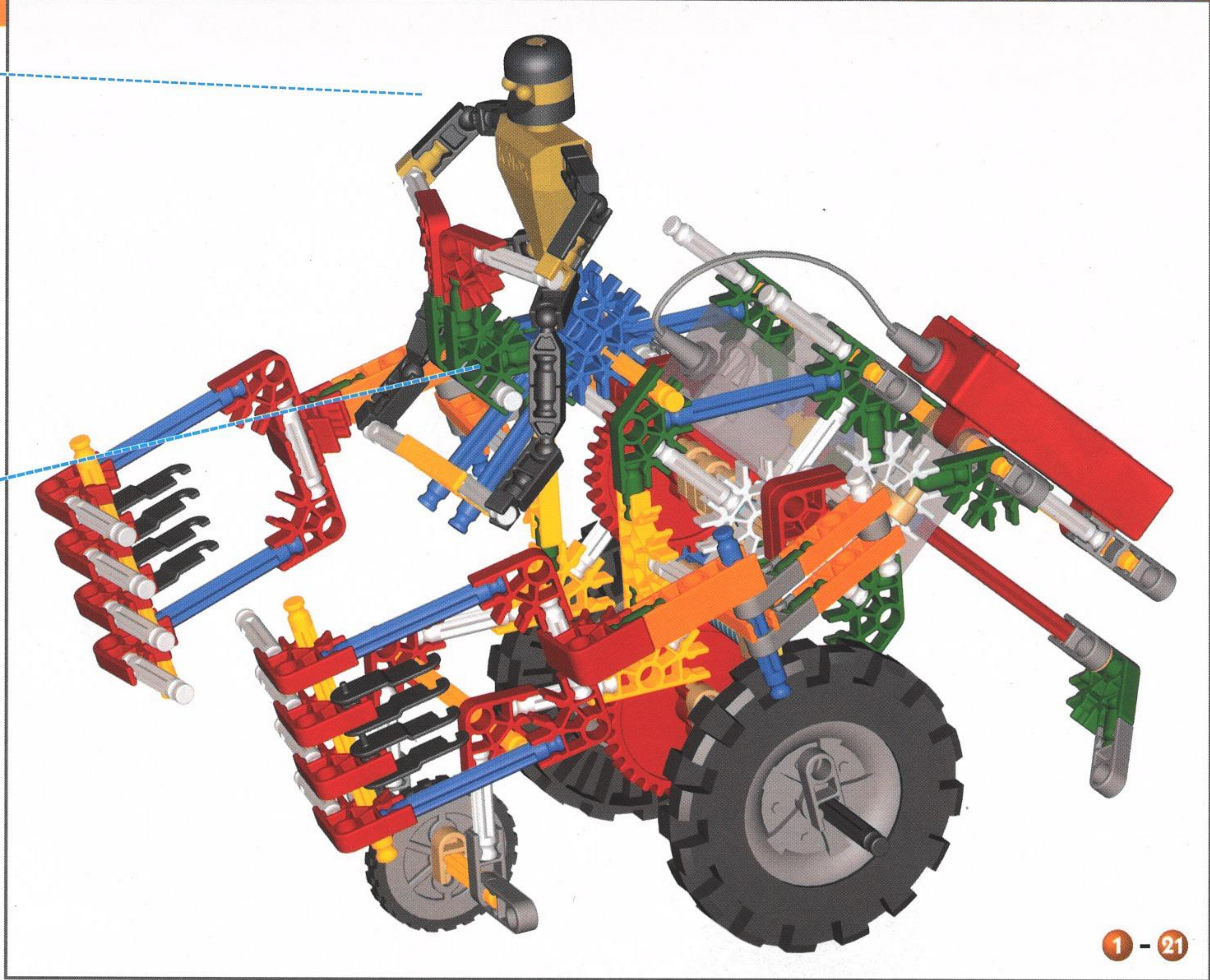
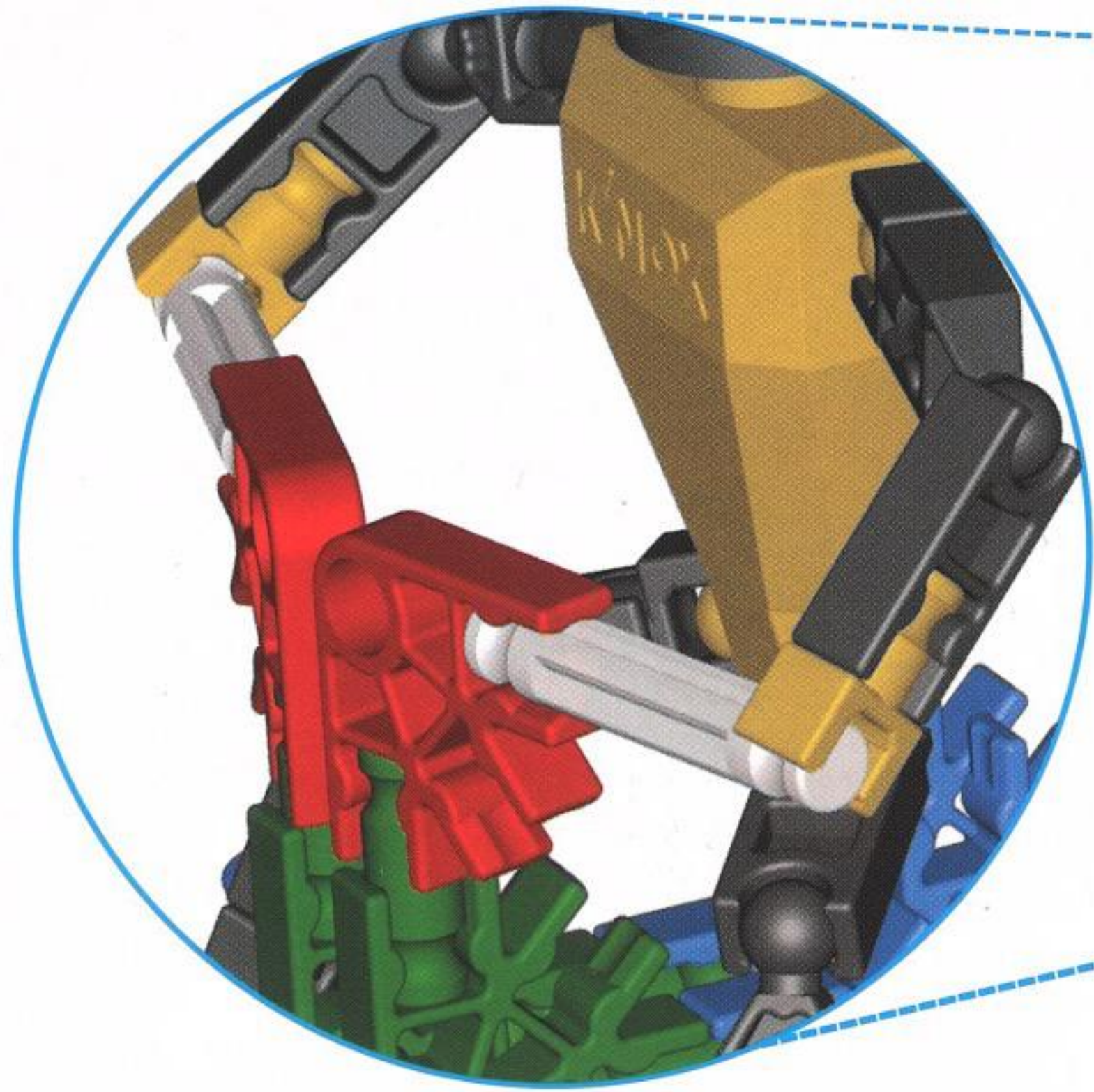

21

Ultrabot

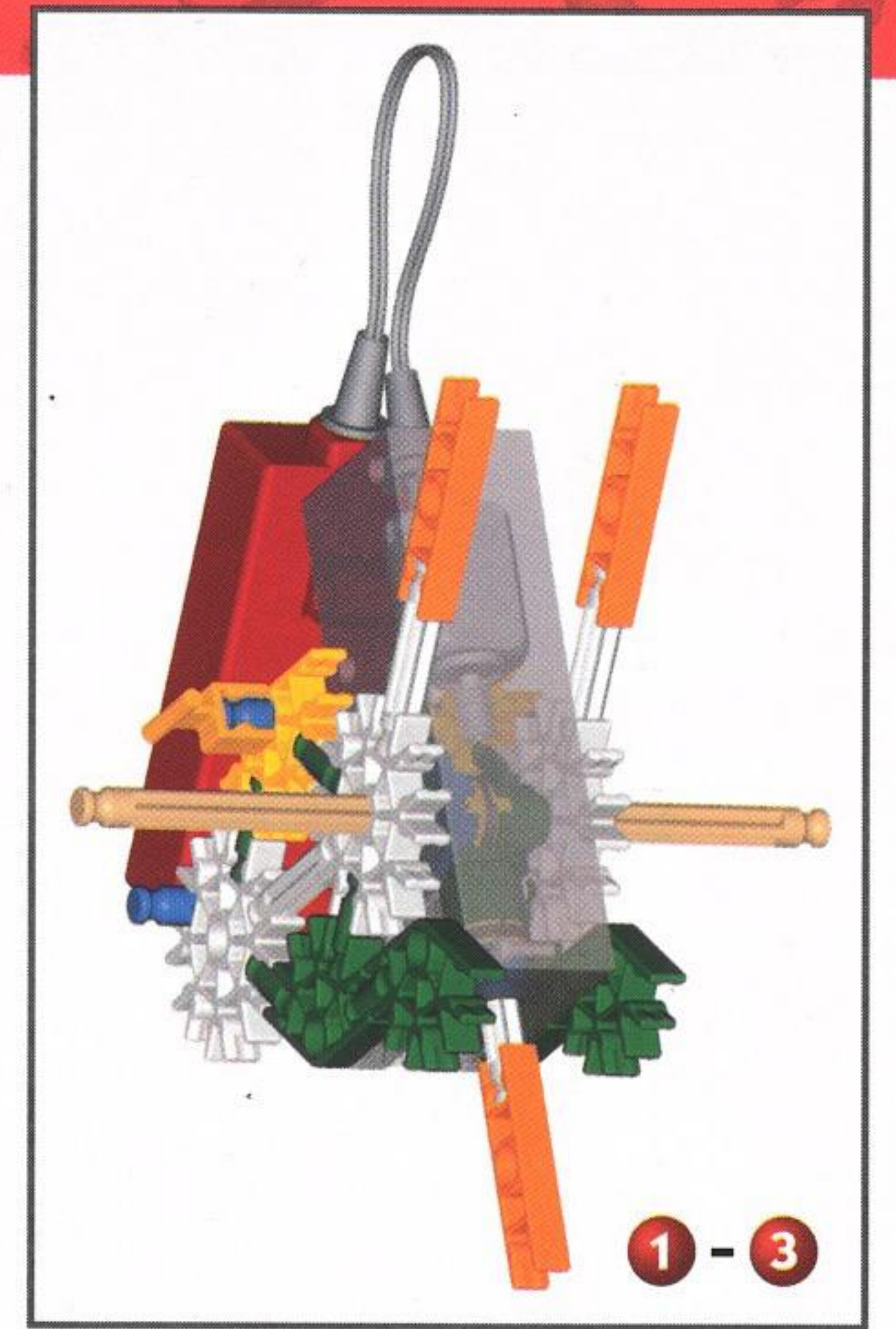

1

2

3

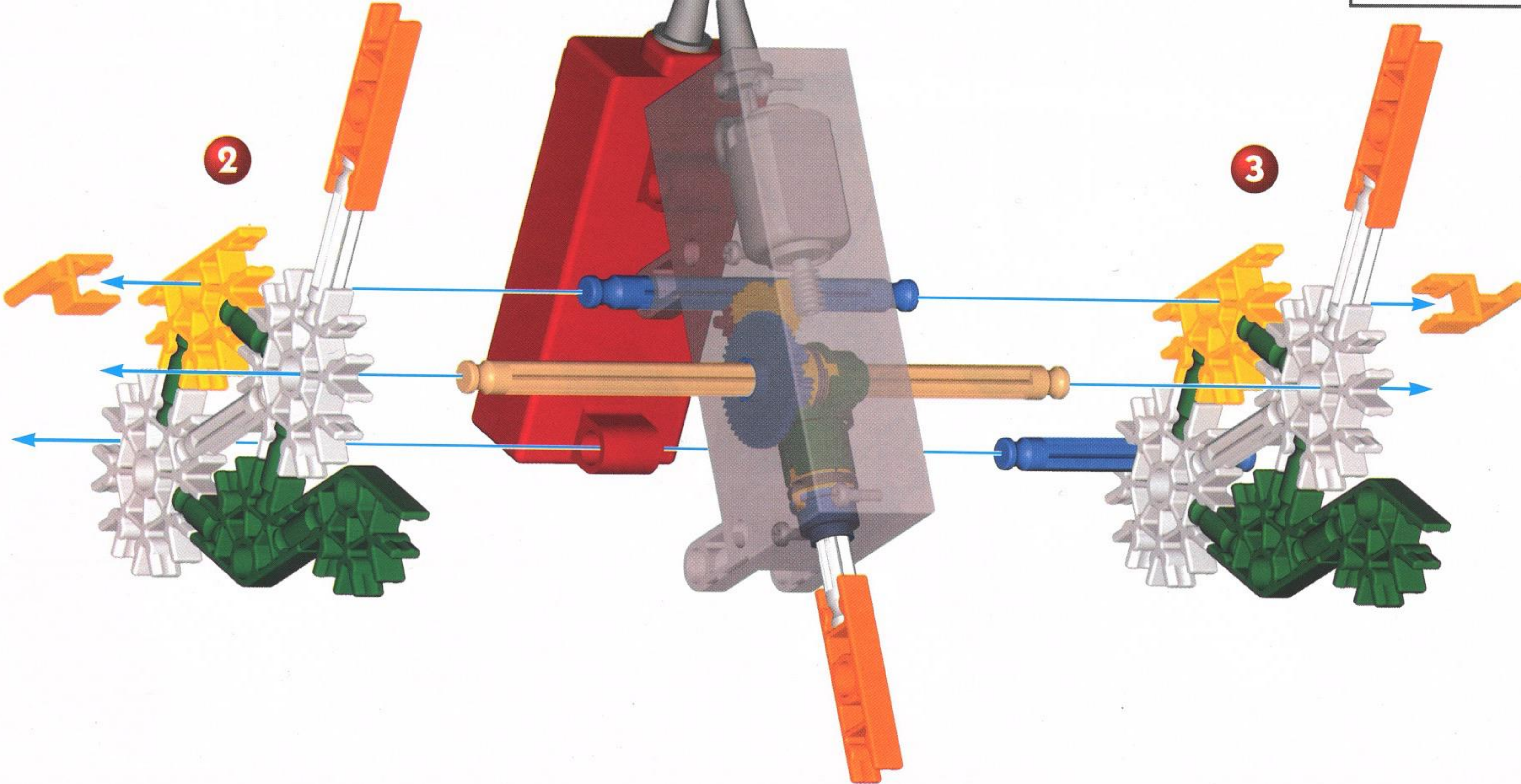

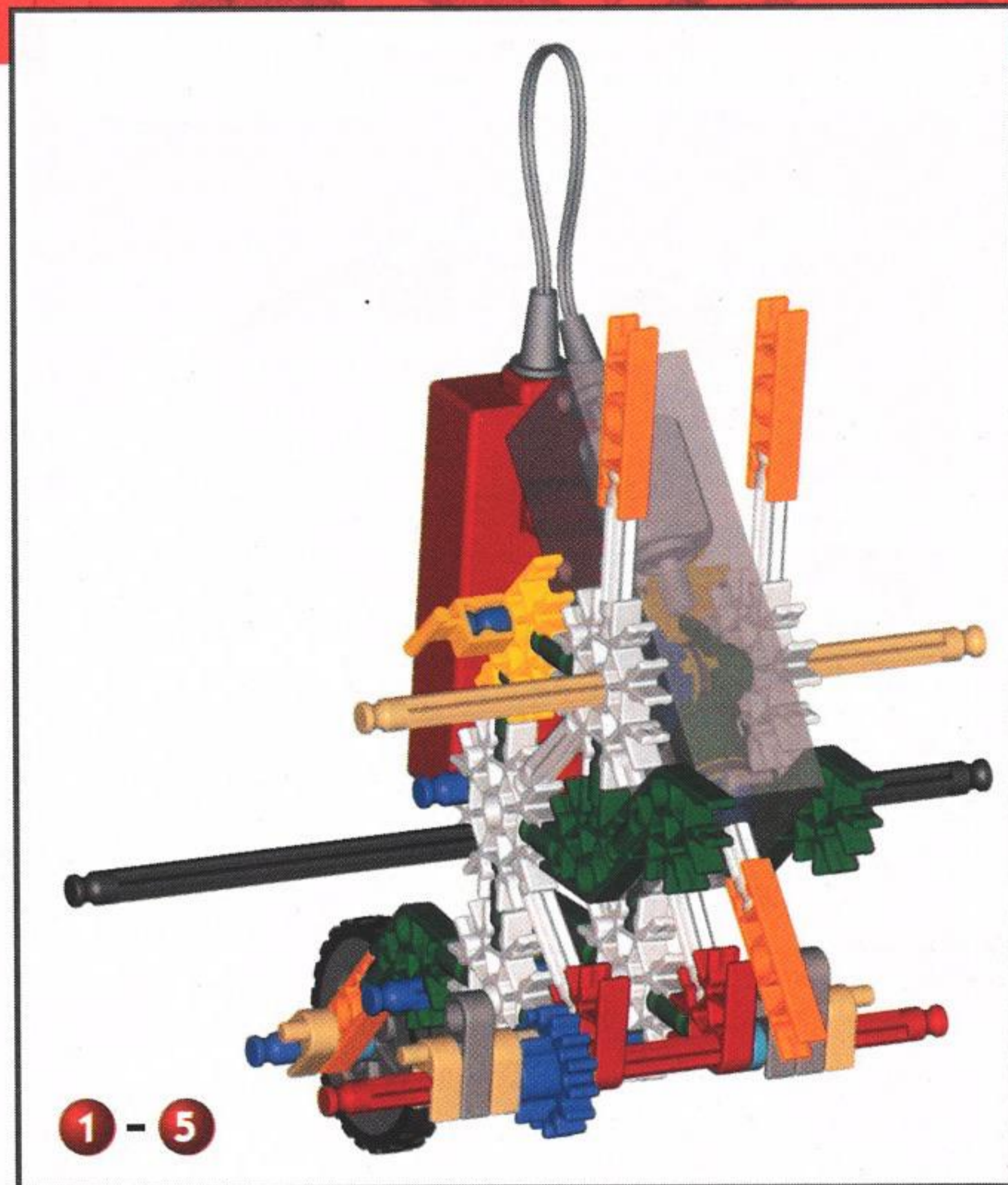
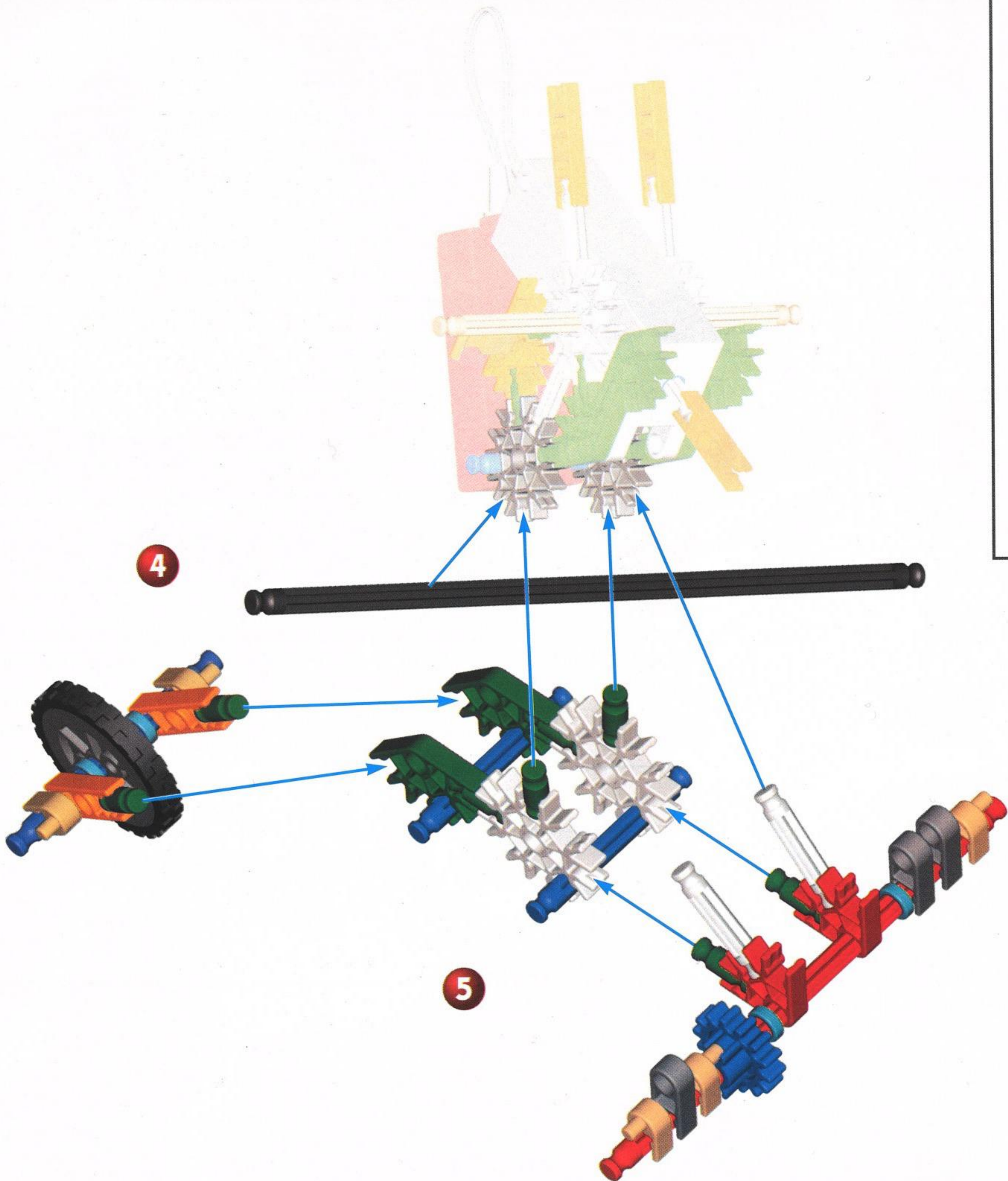

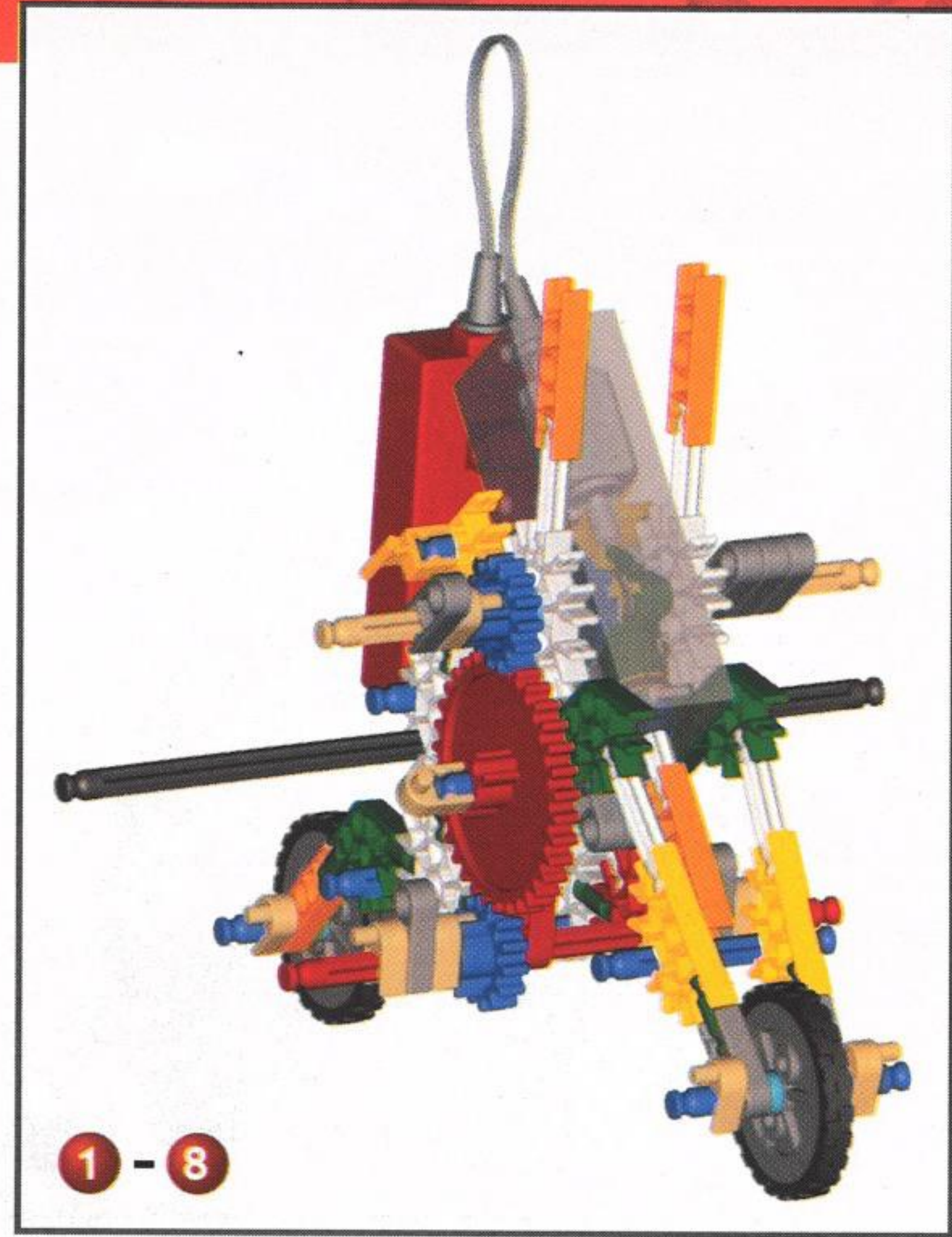
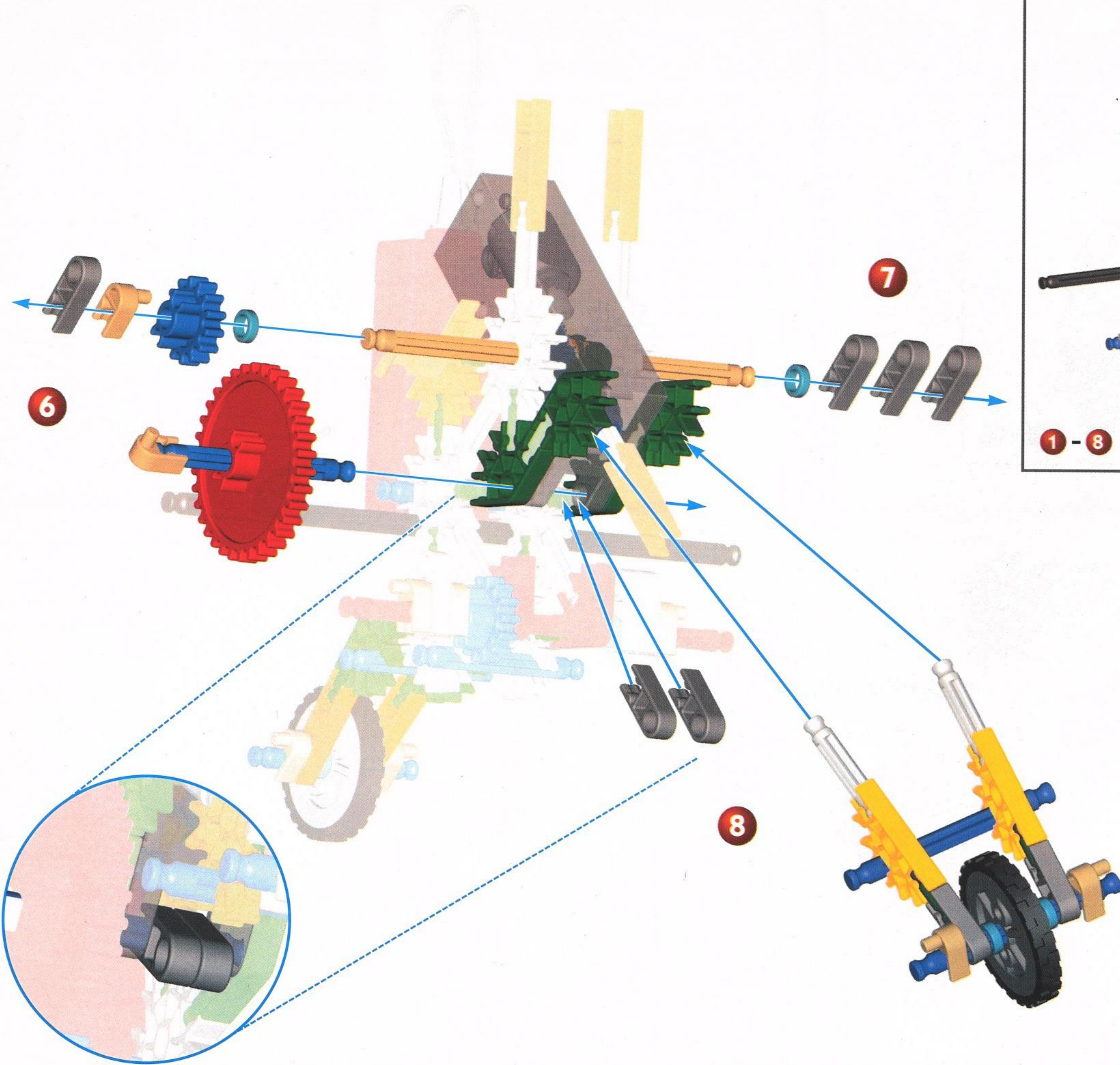

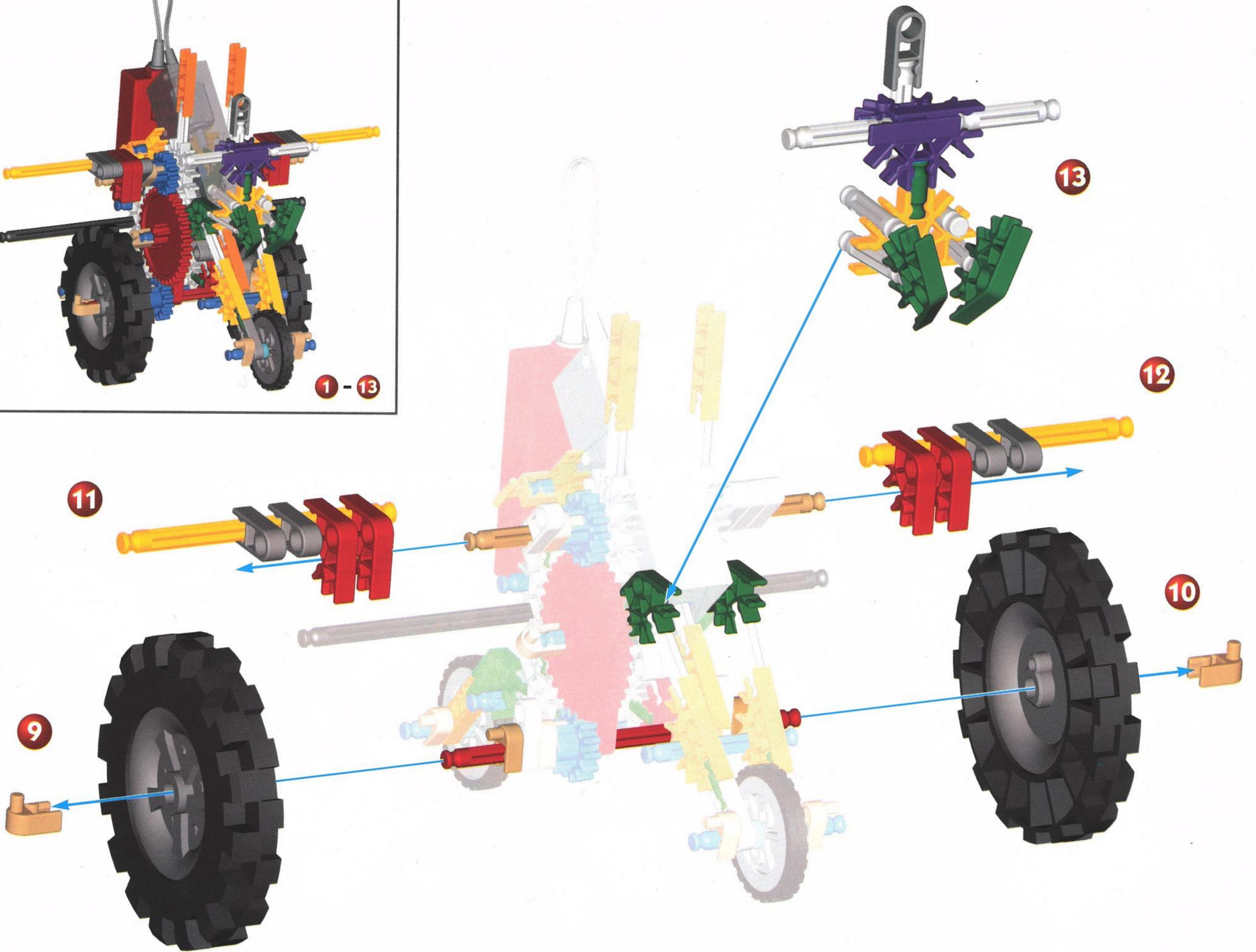
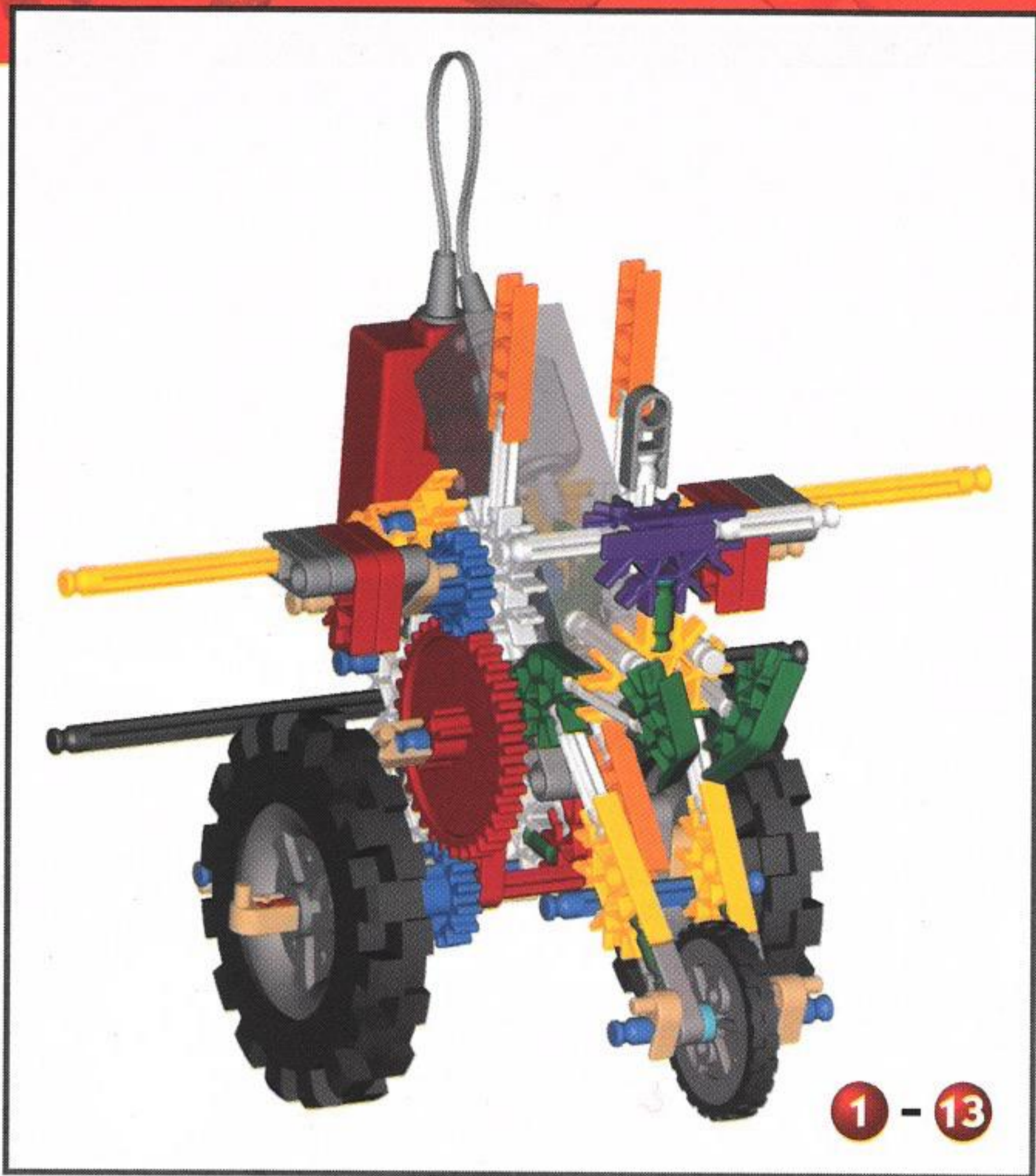

14



15

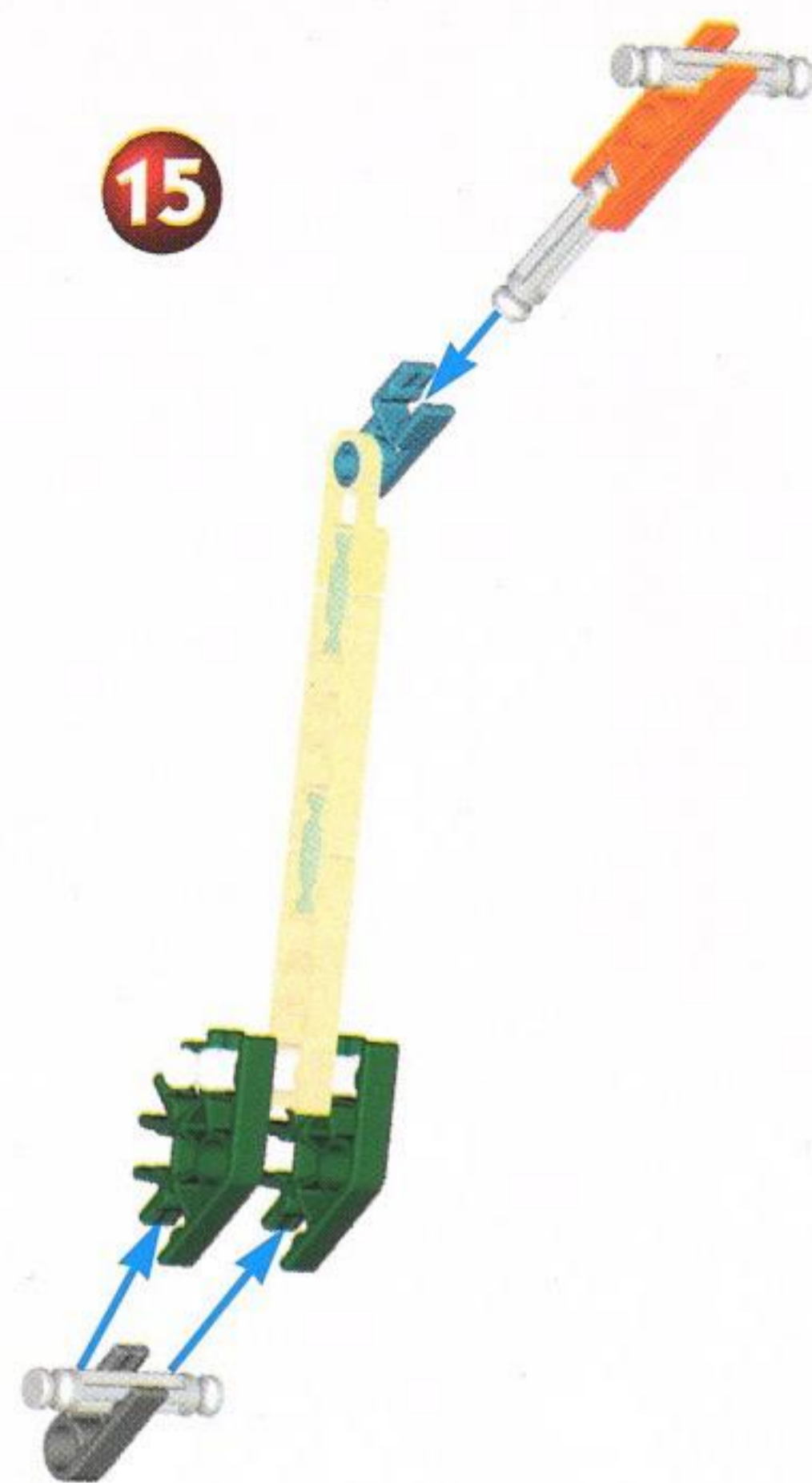

16



17

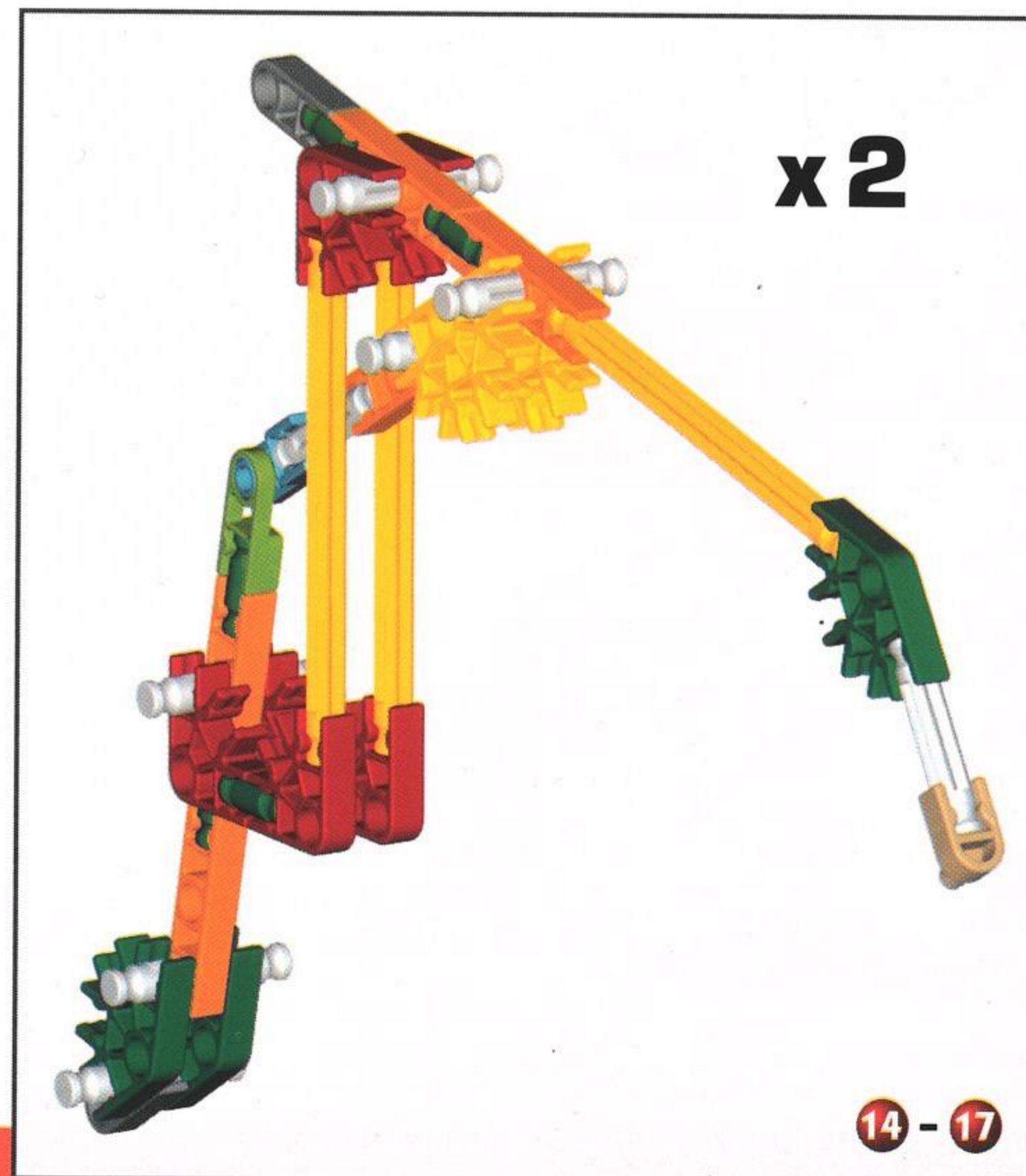
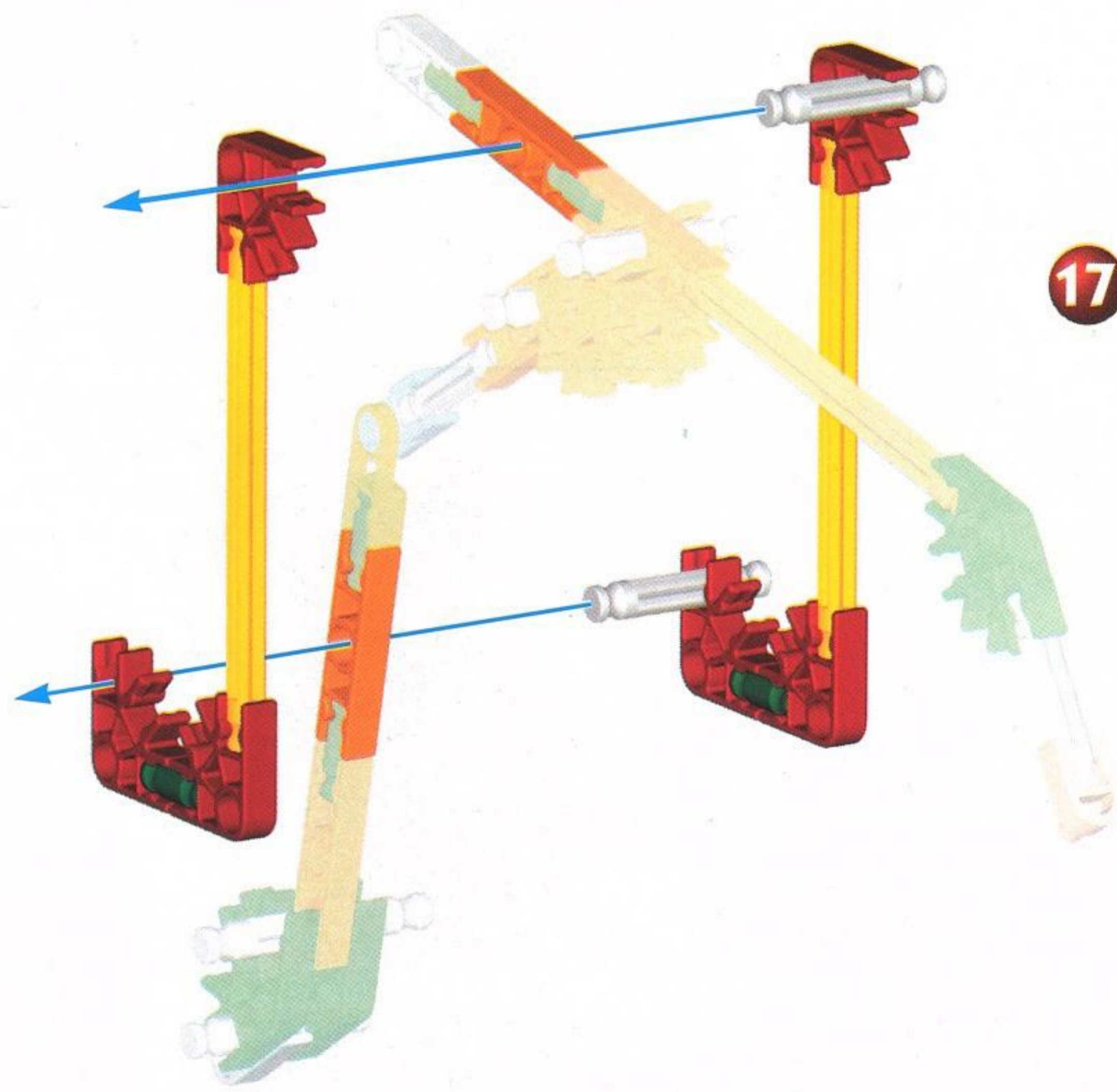

x 2

14 - 17

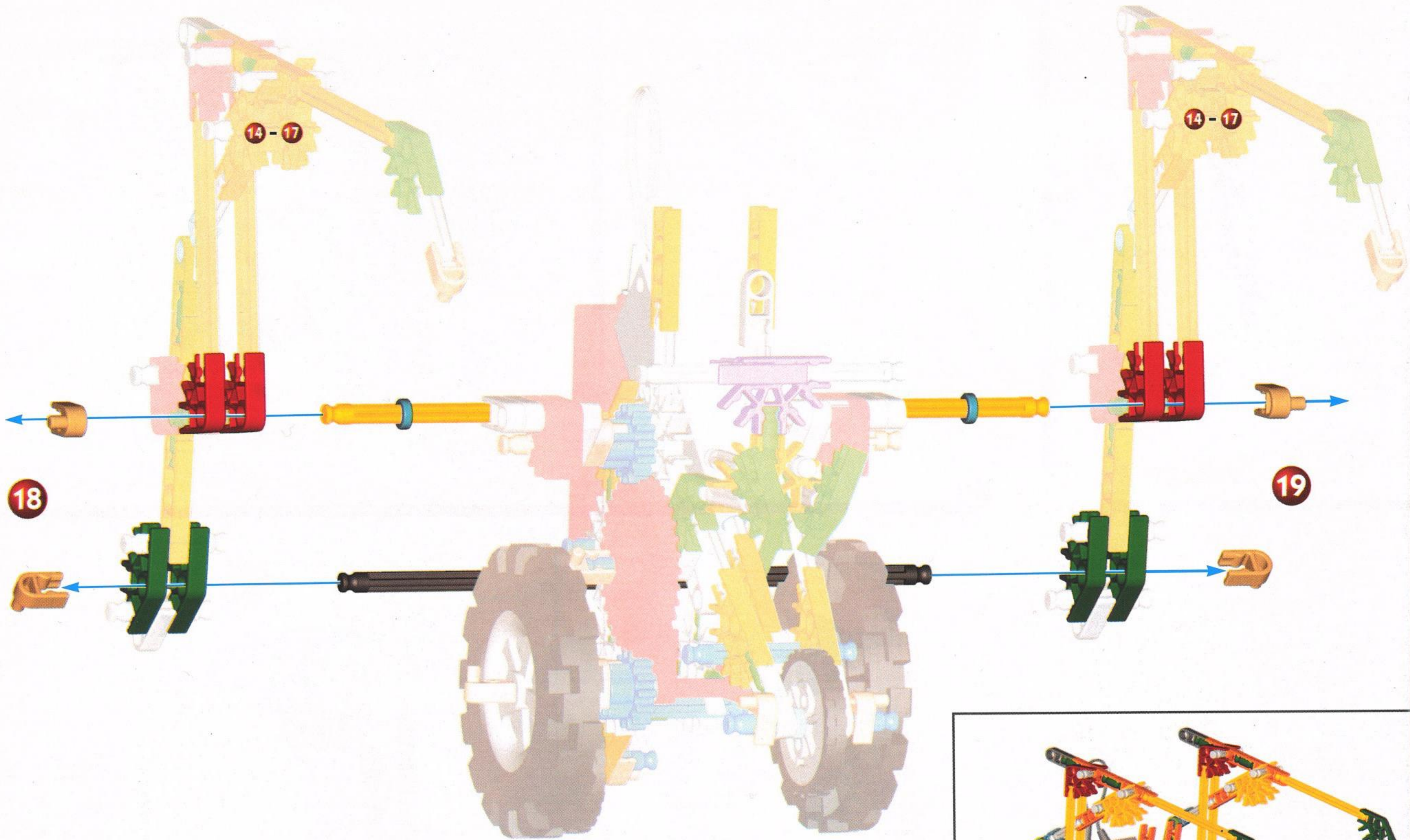

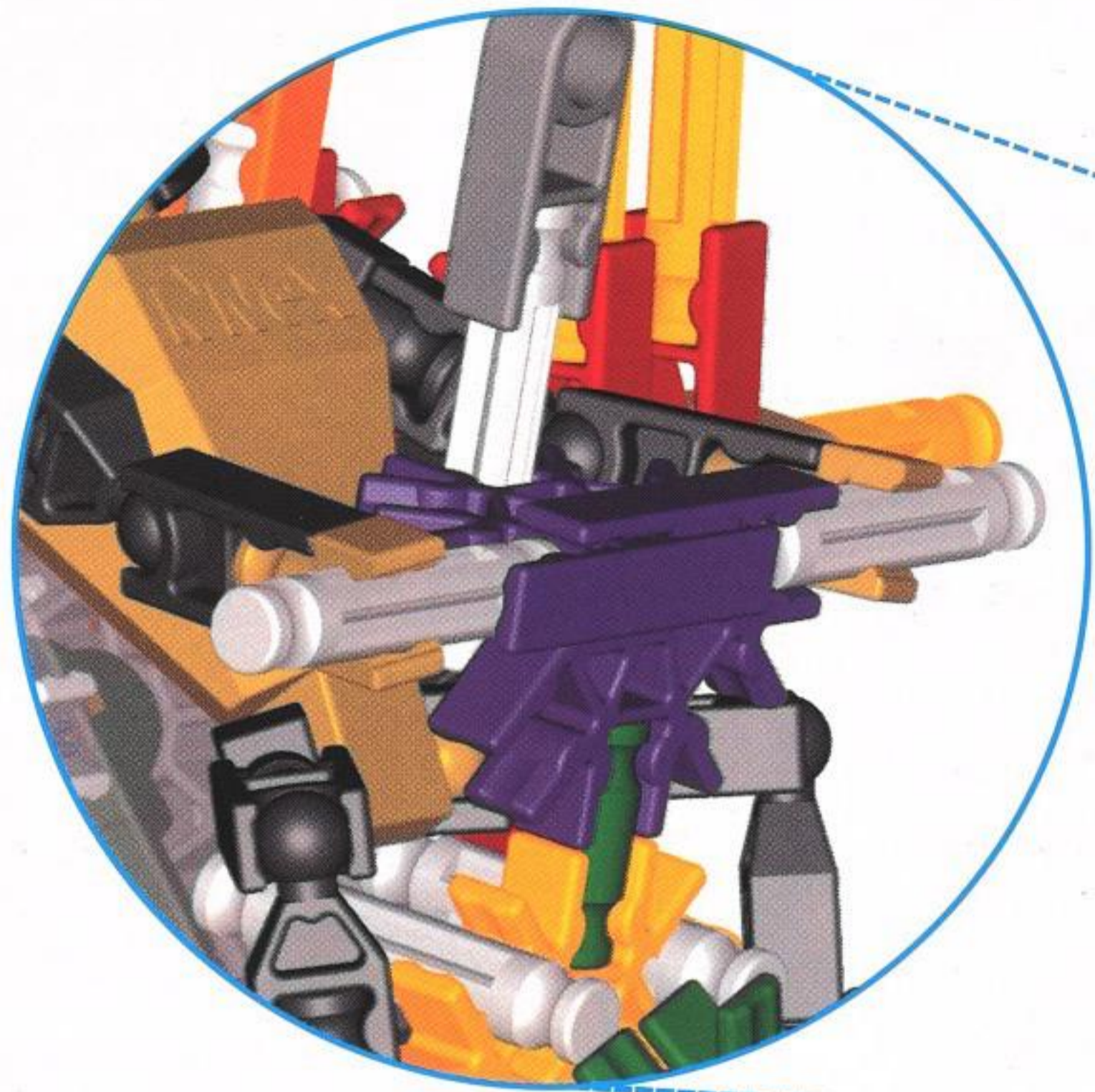

20

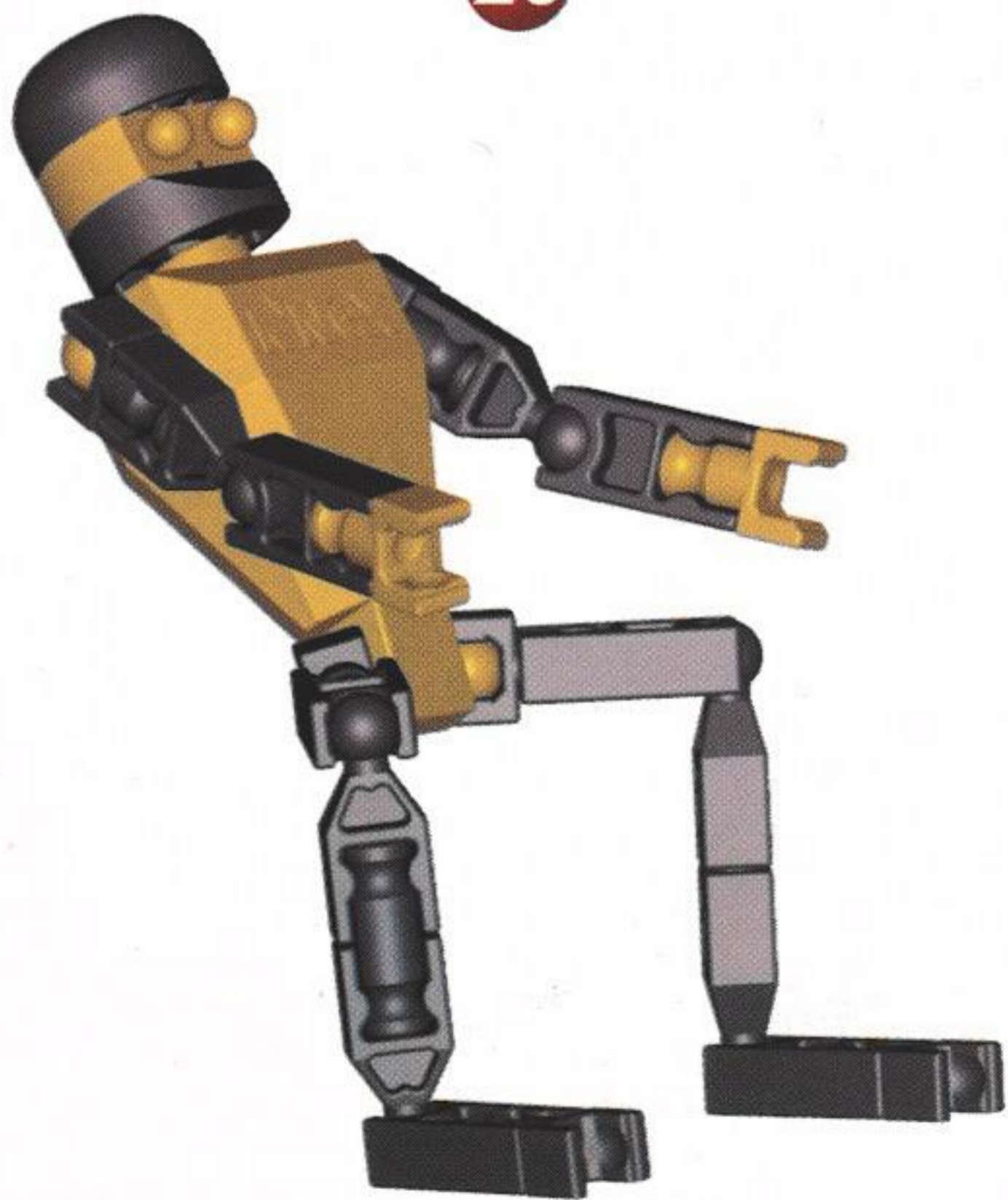

1 - 20

Reacher

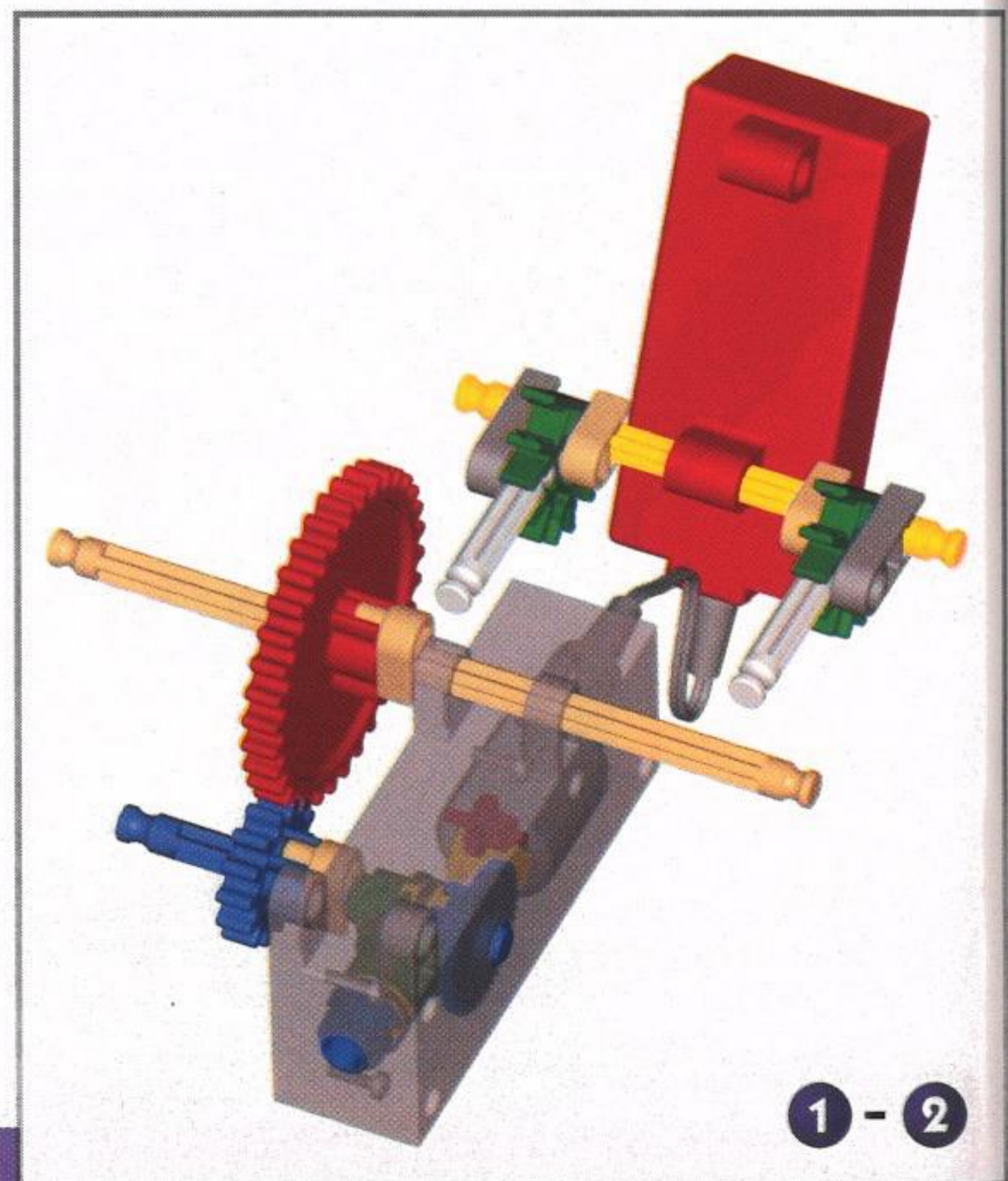
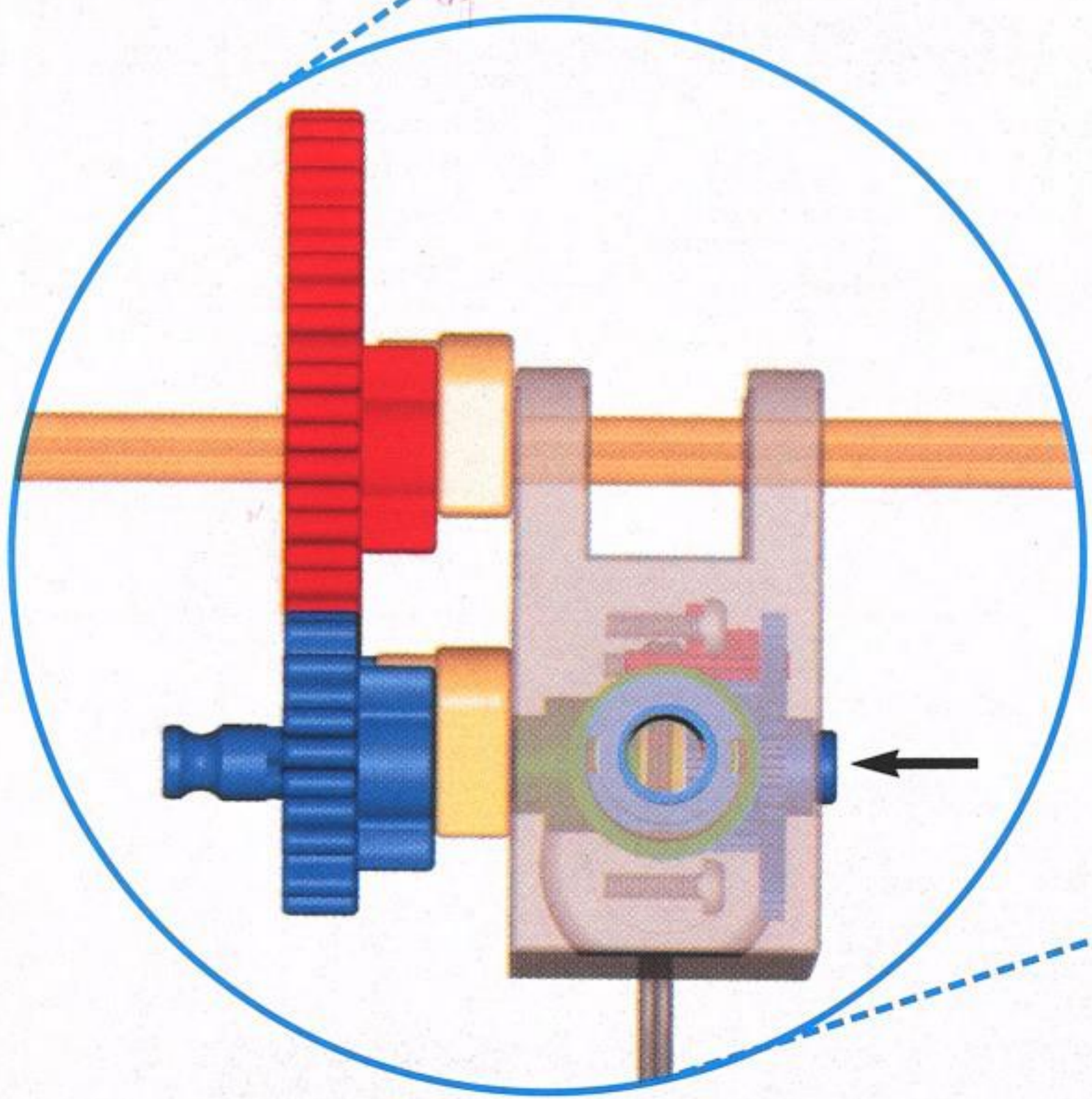
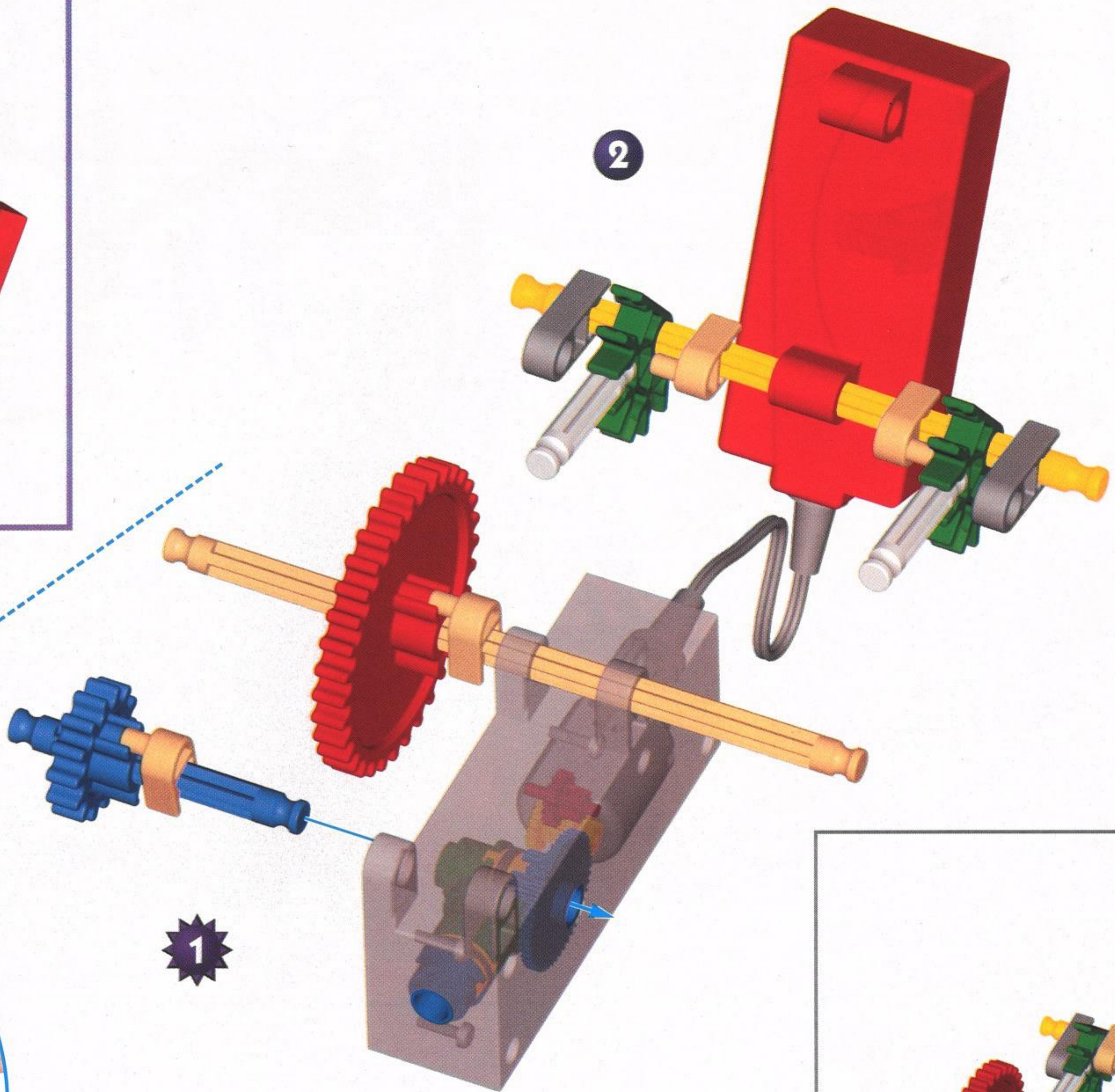

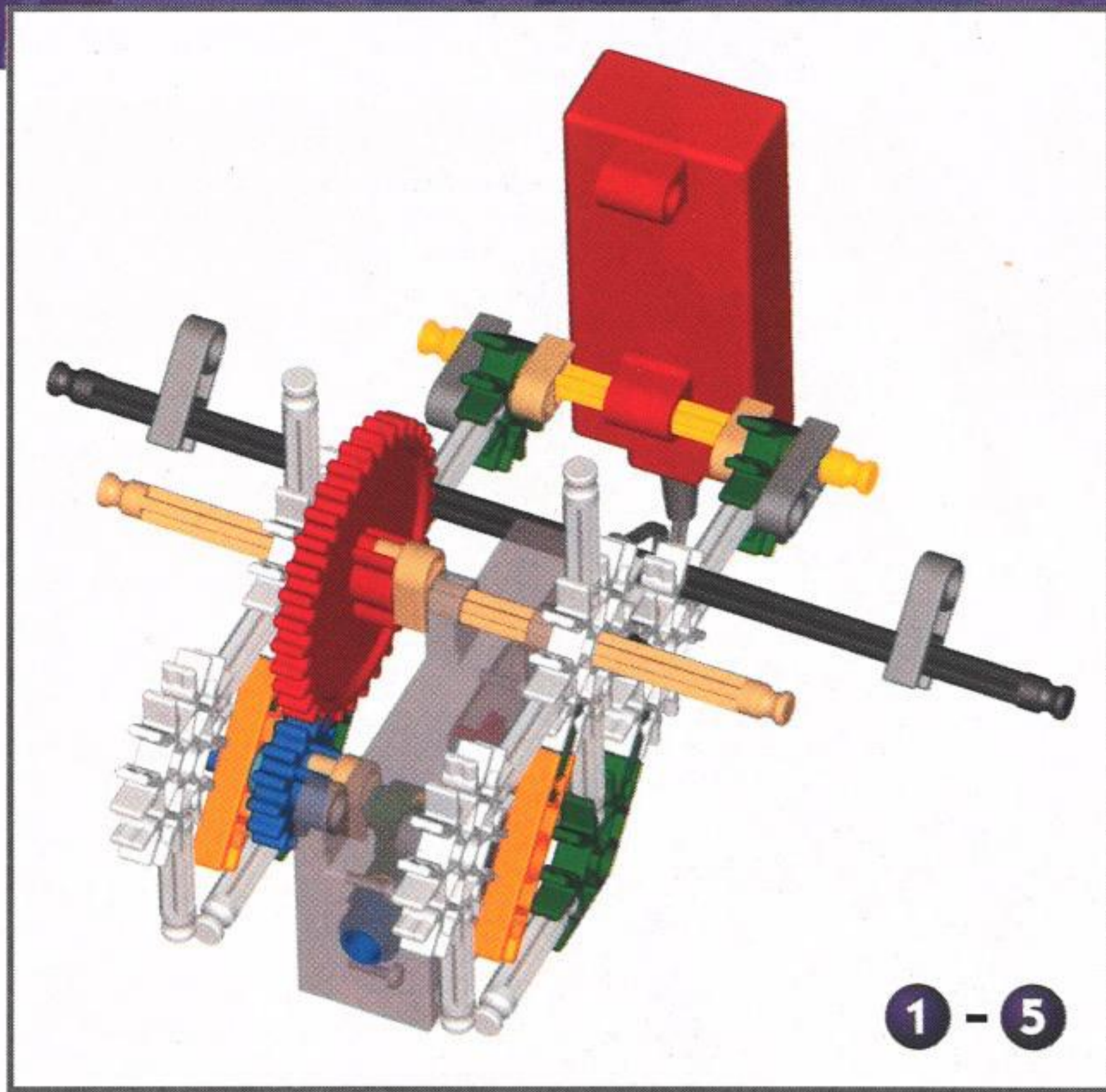

3

5

4

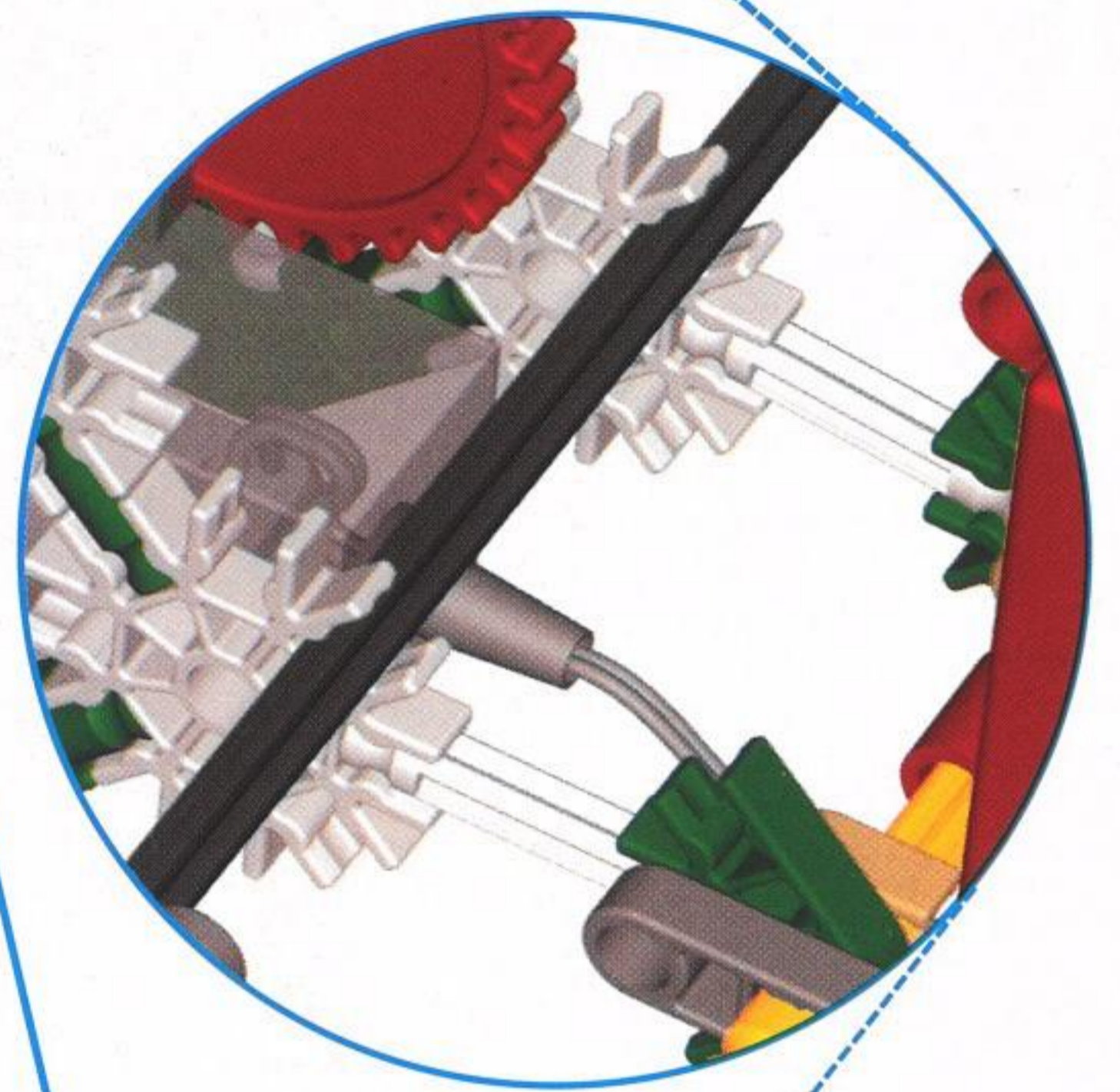

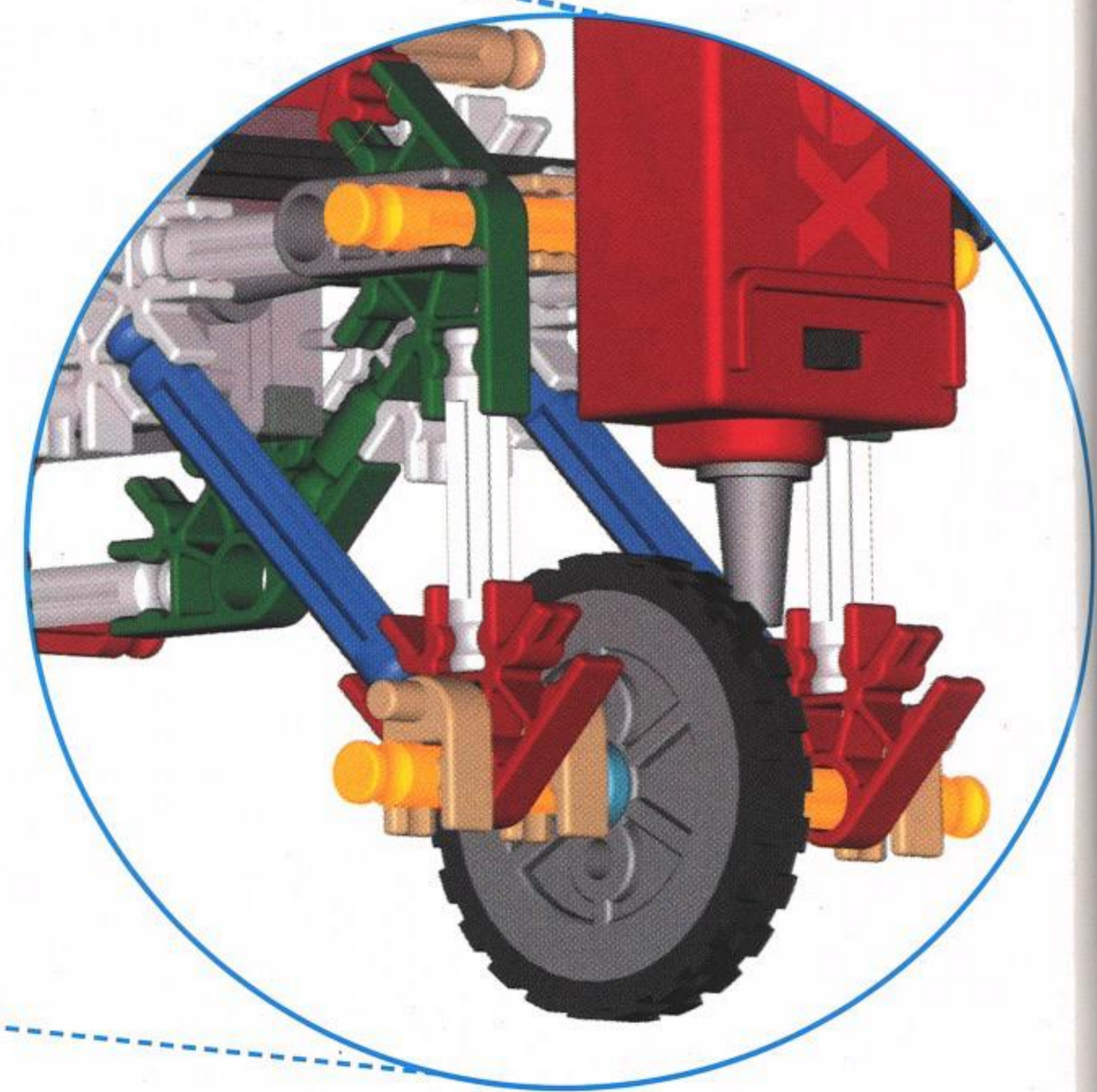
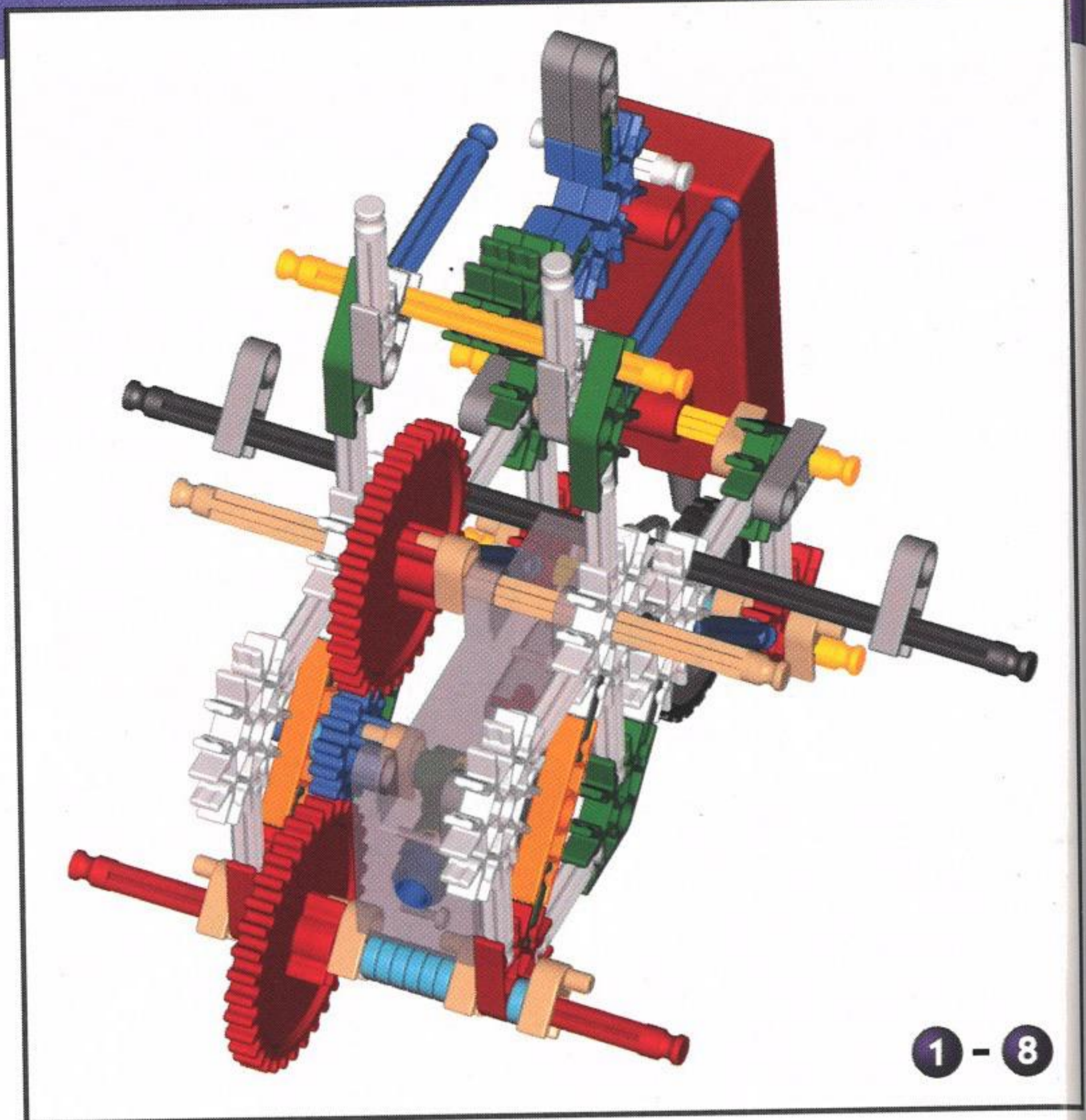
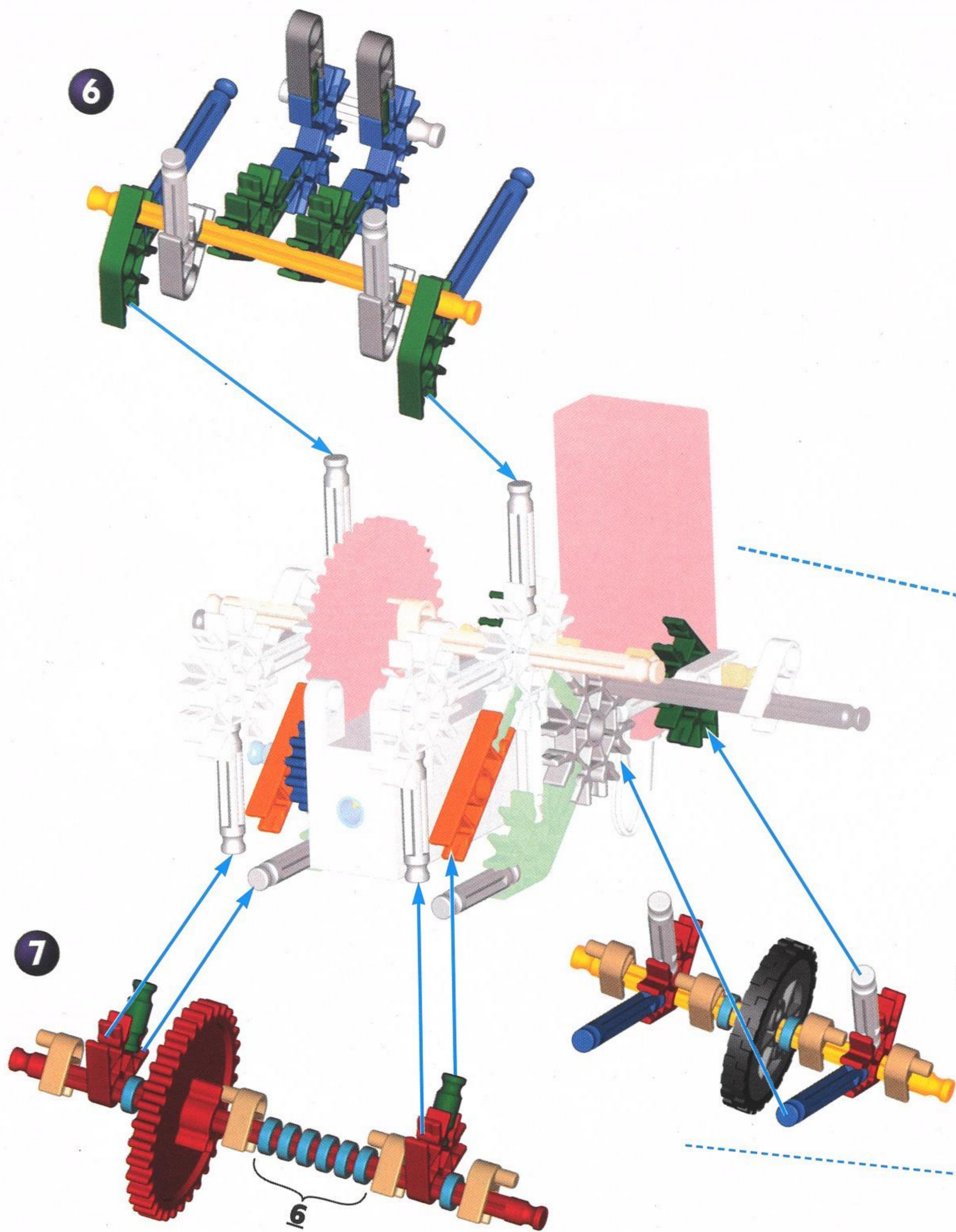

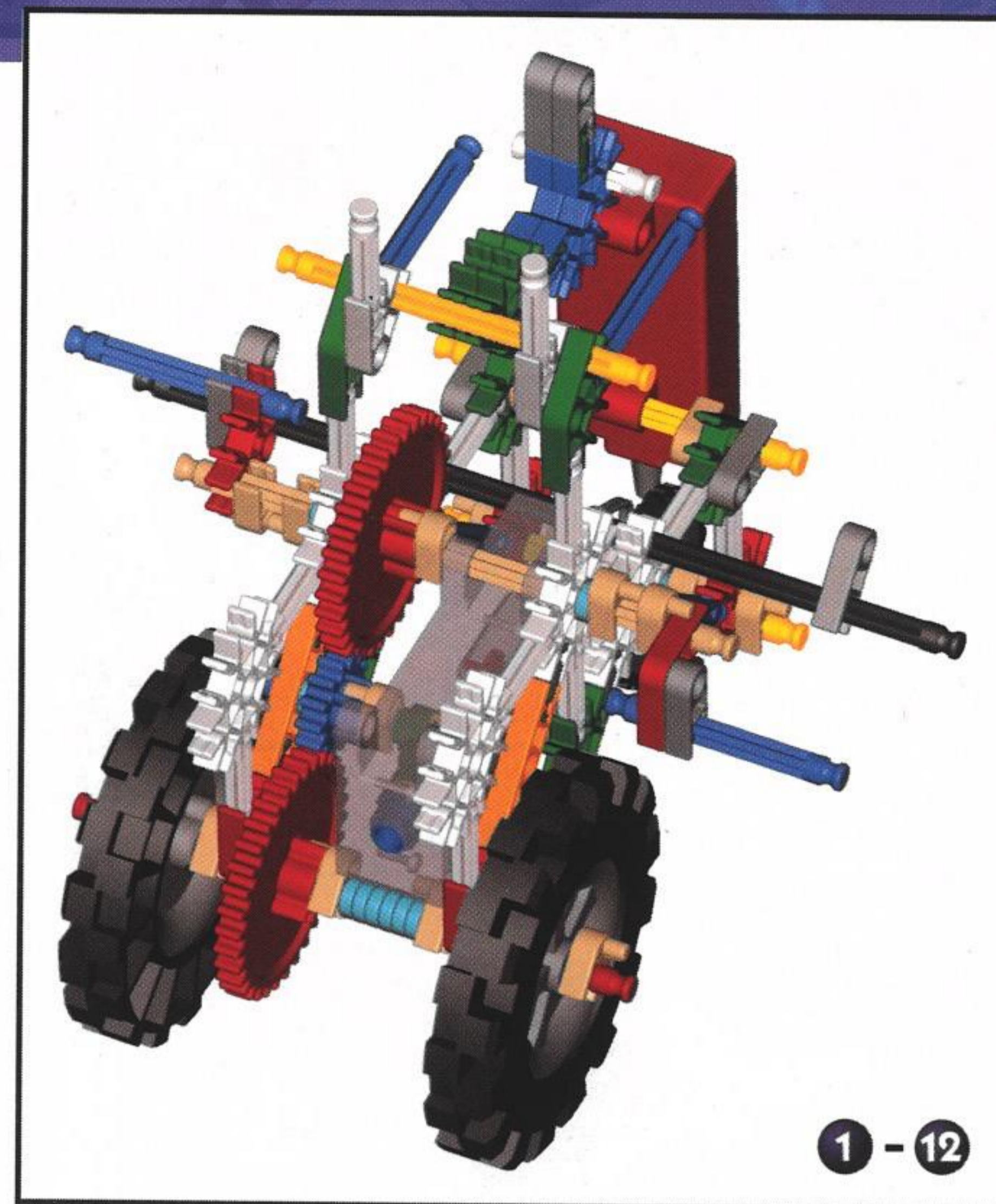
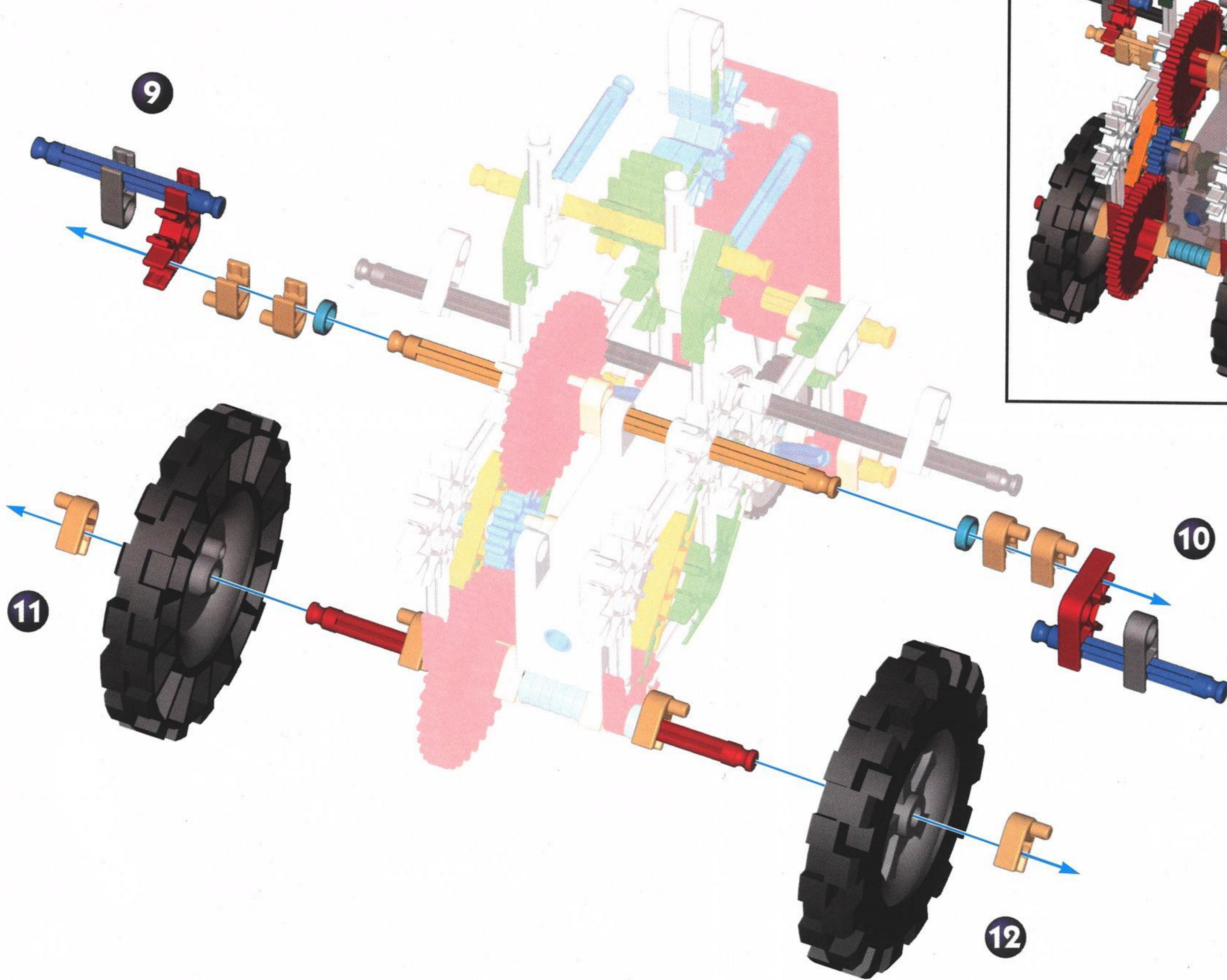

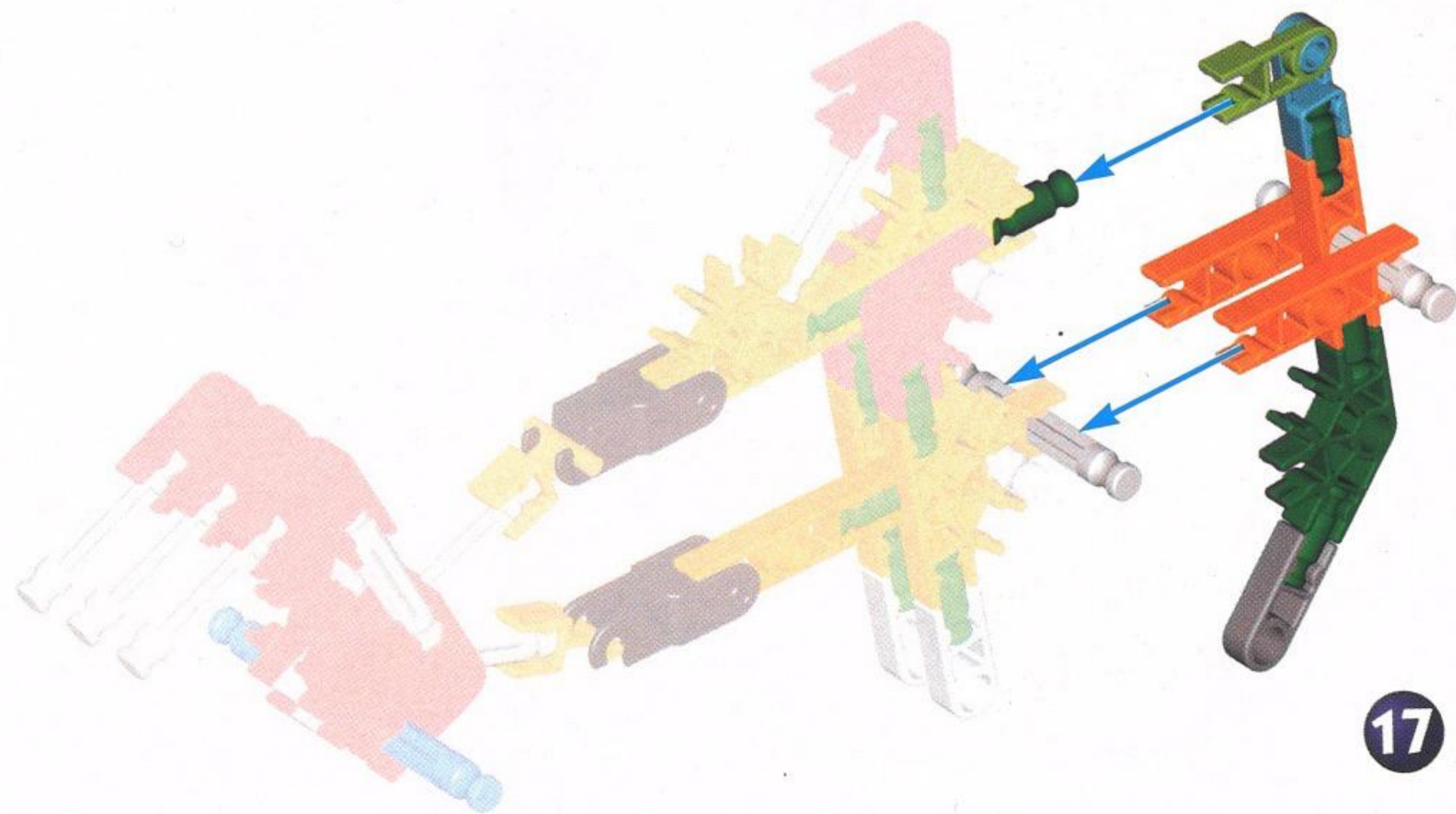
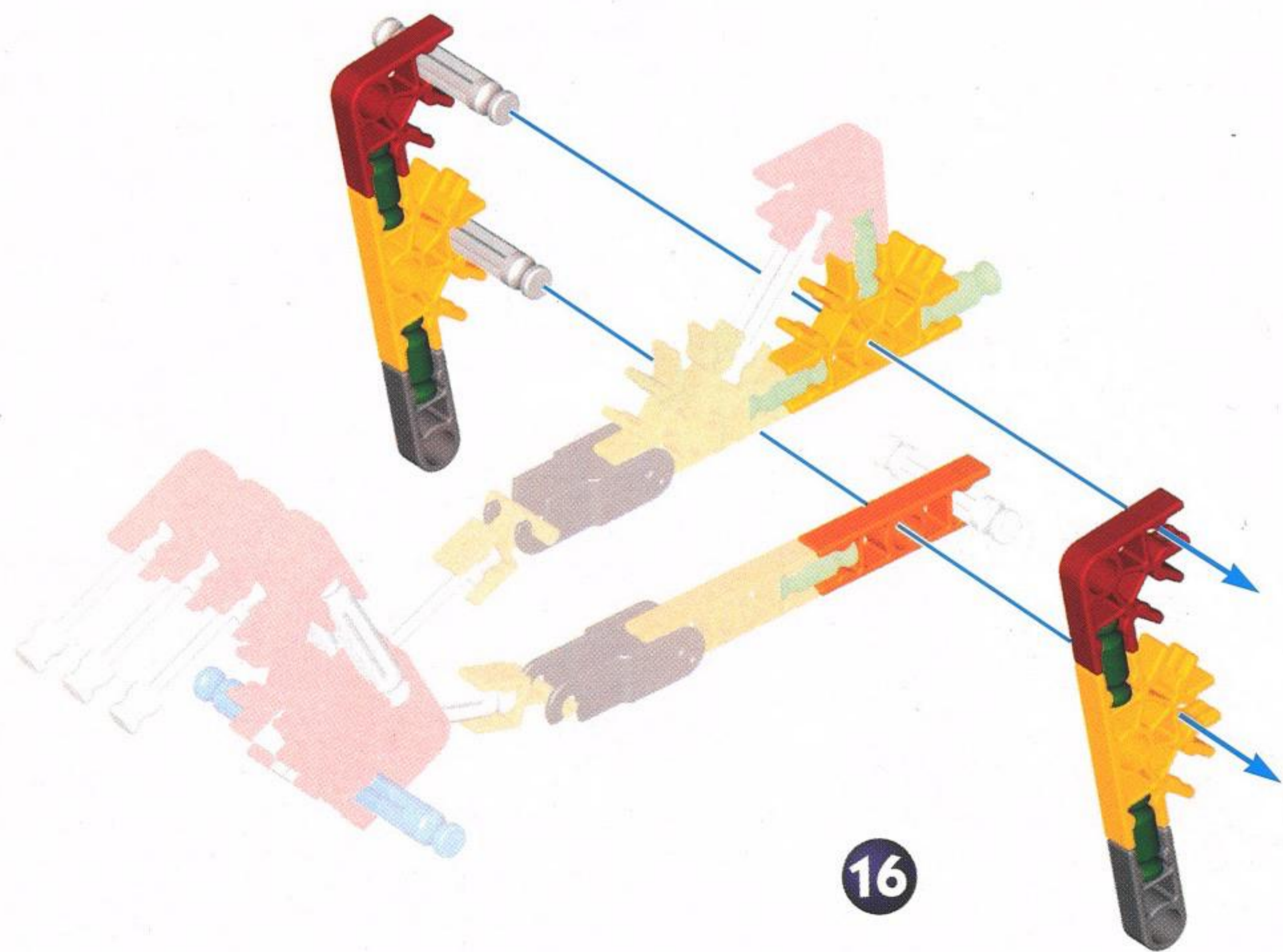
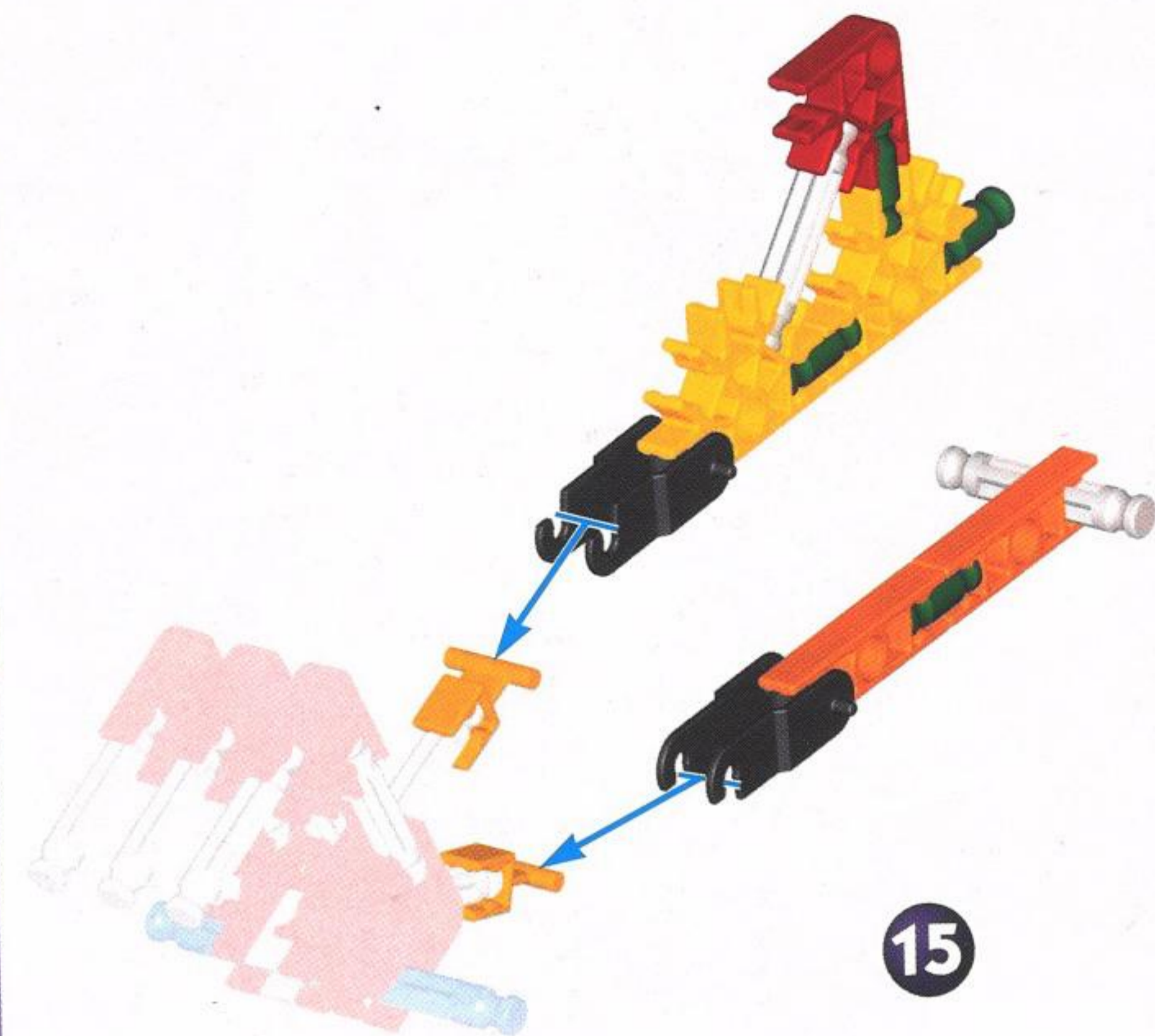
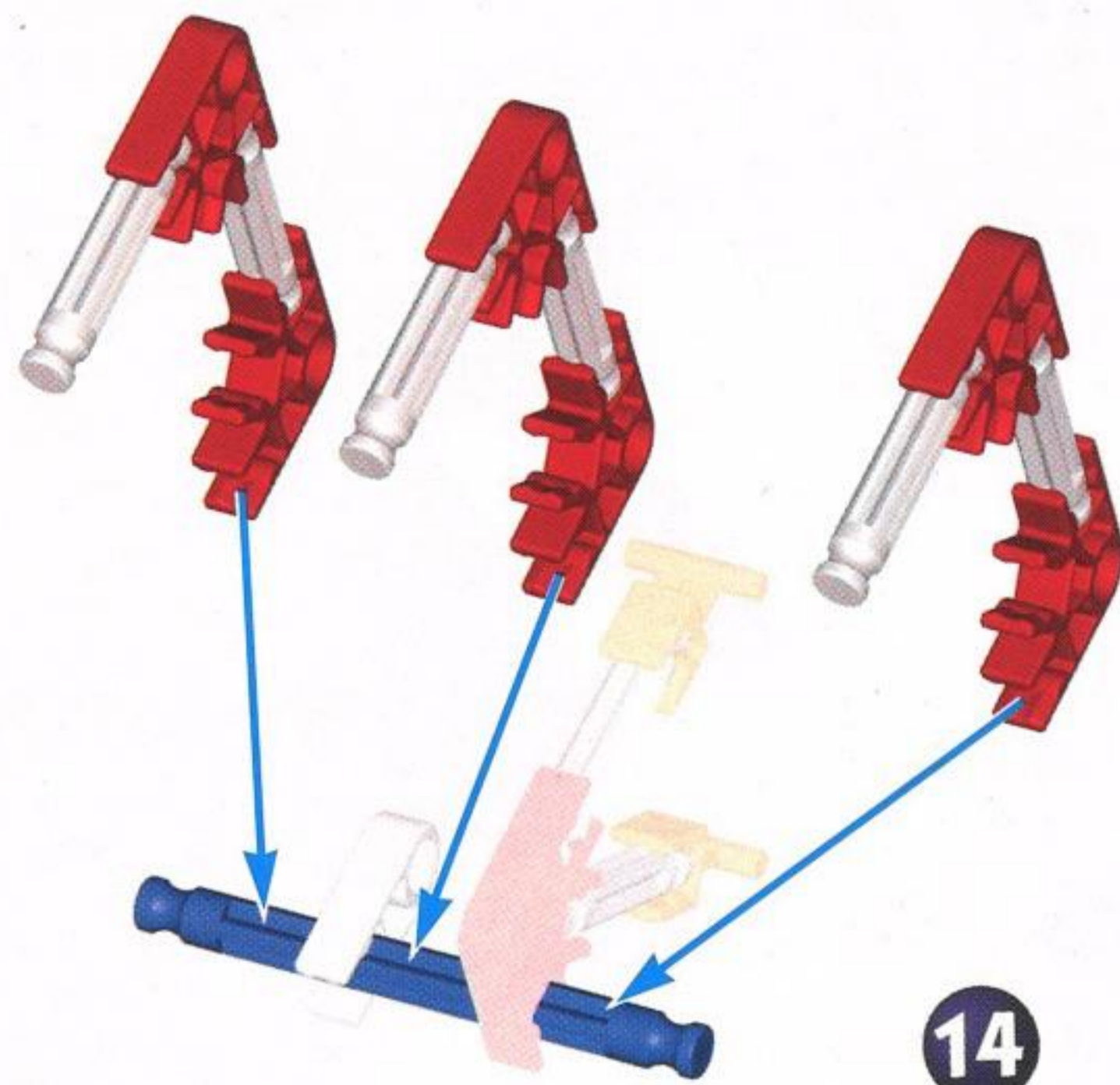
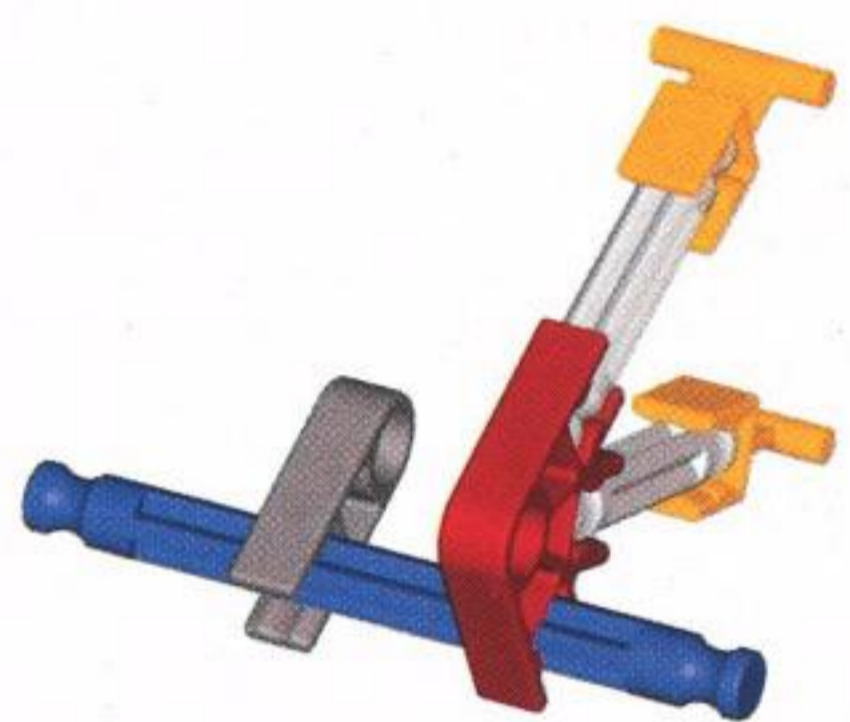
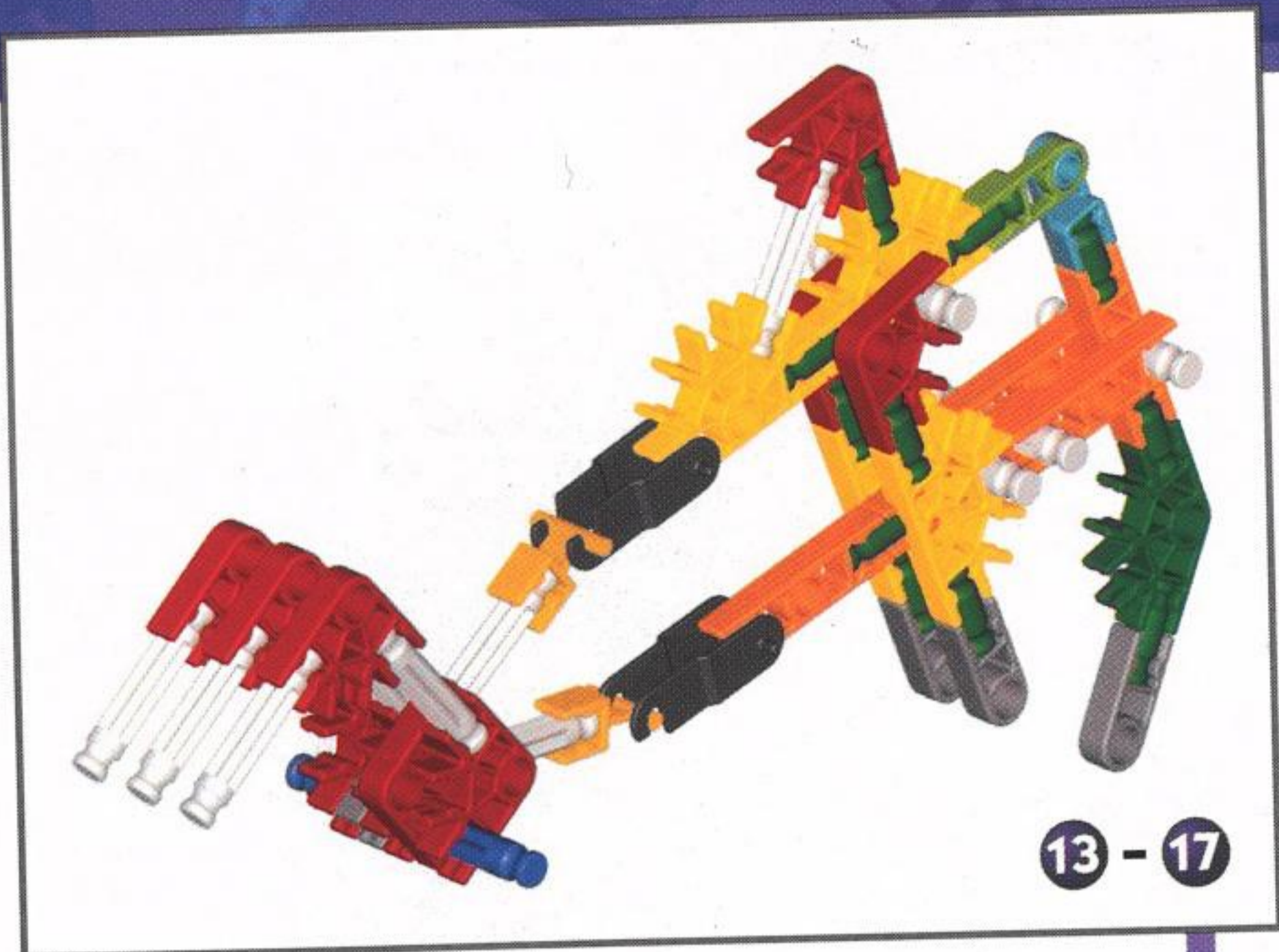

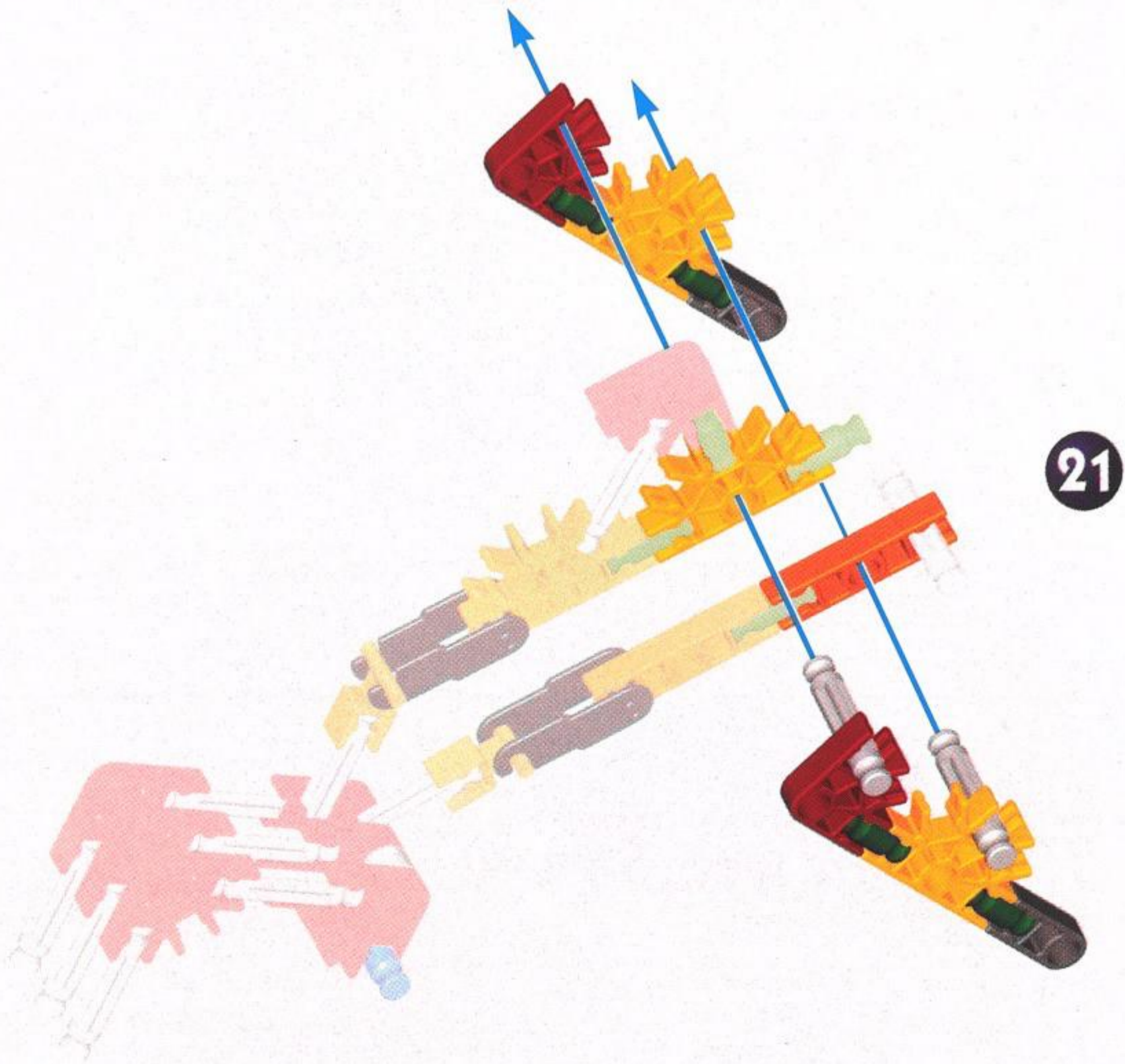
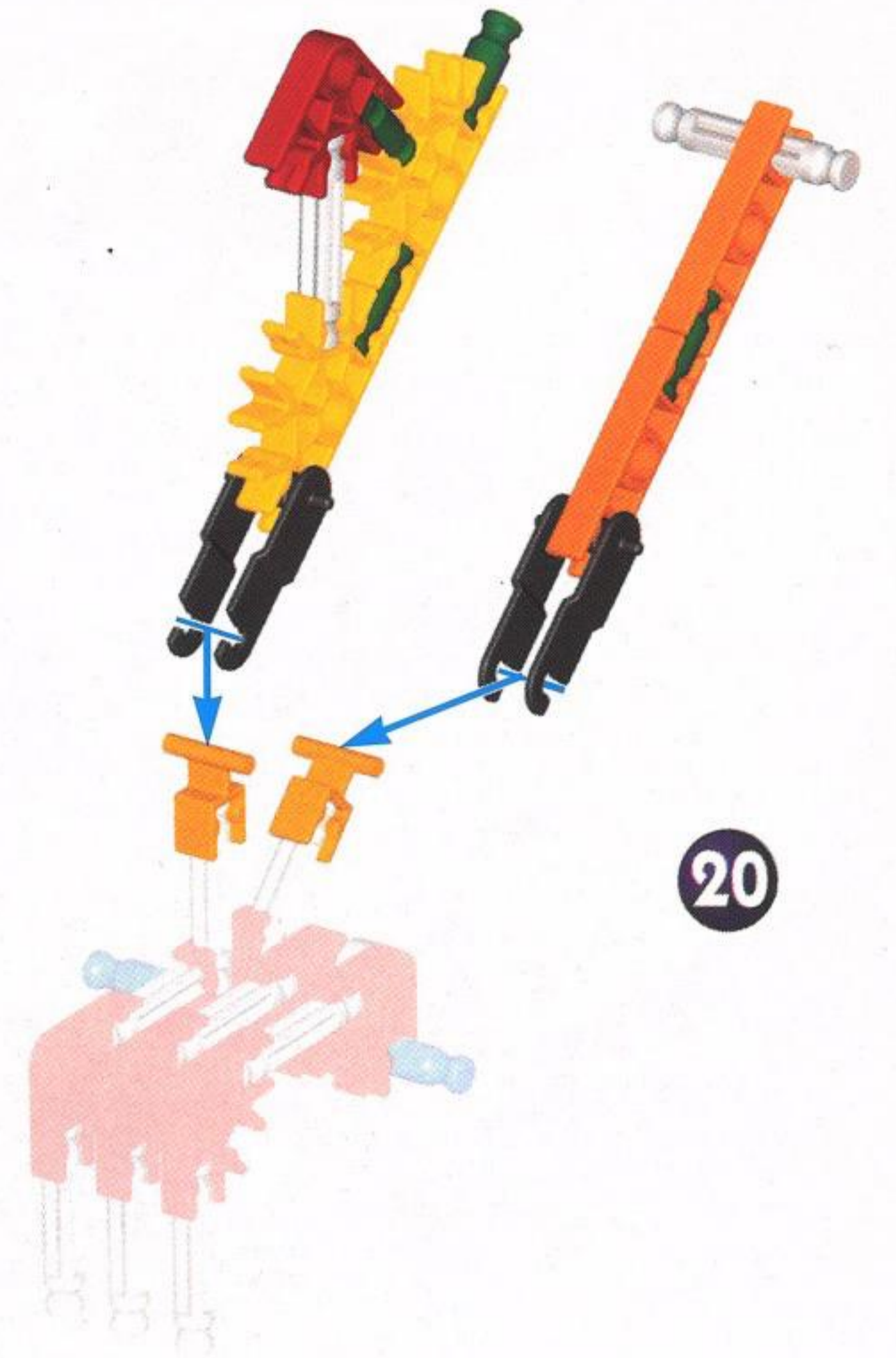
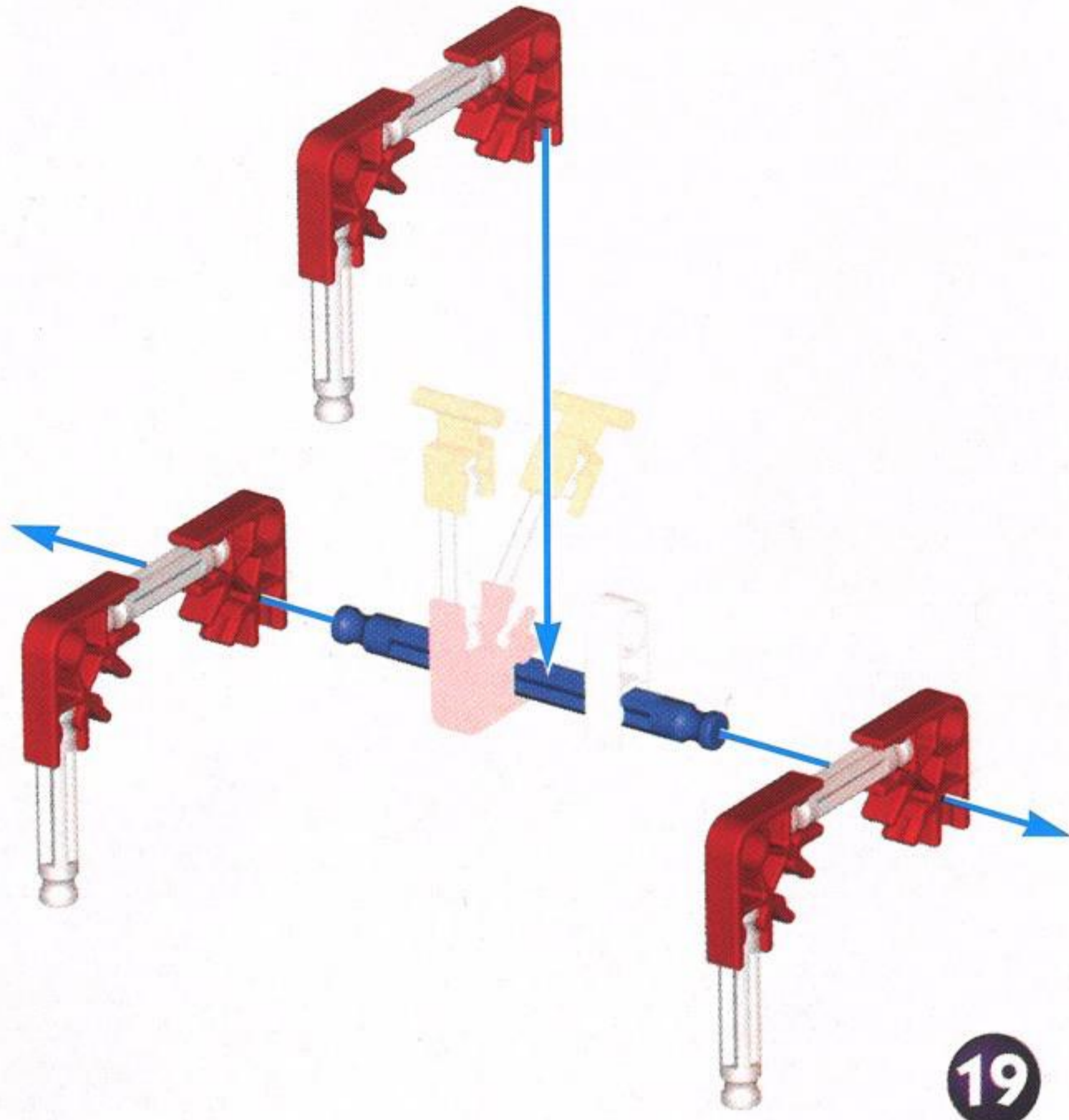
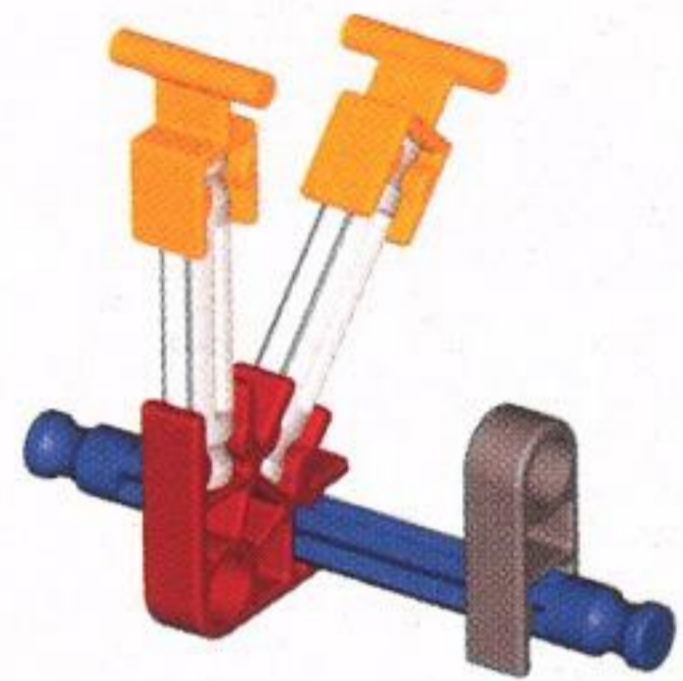

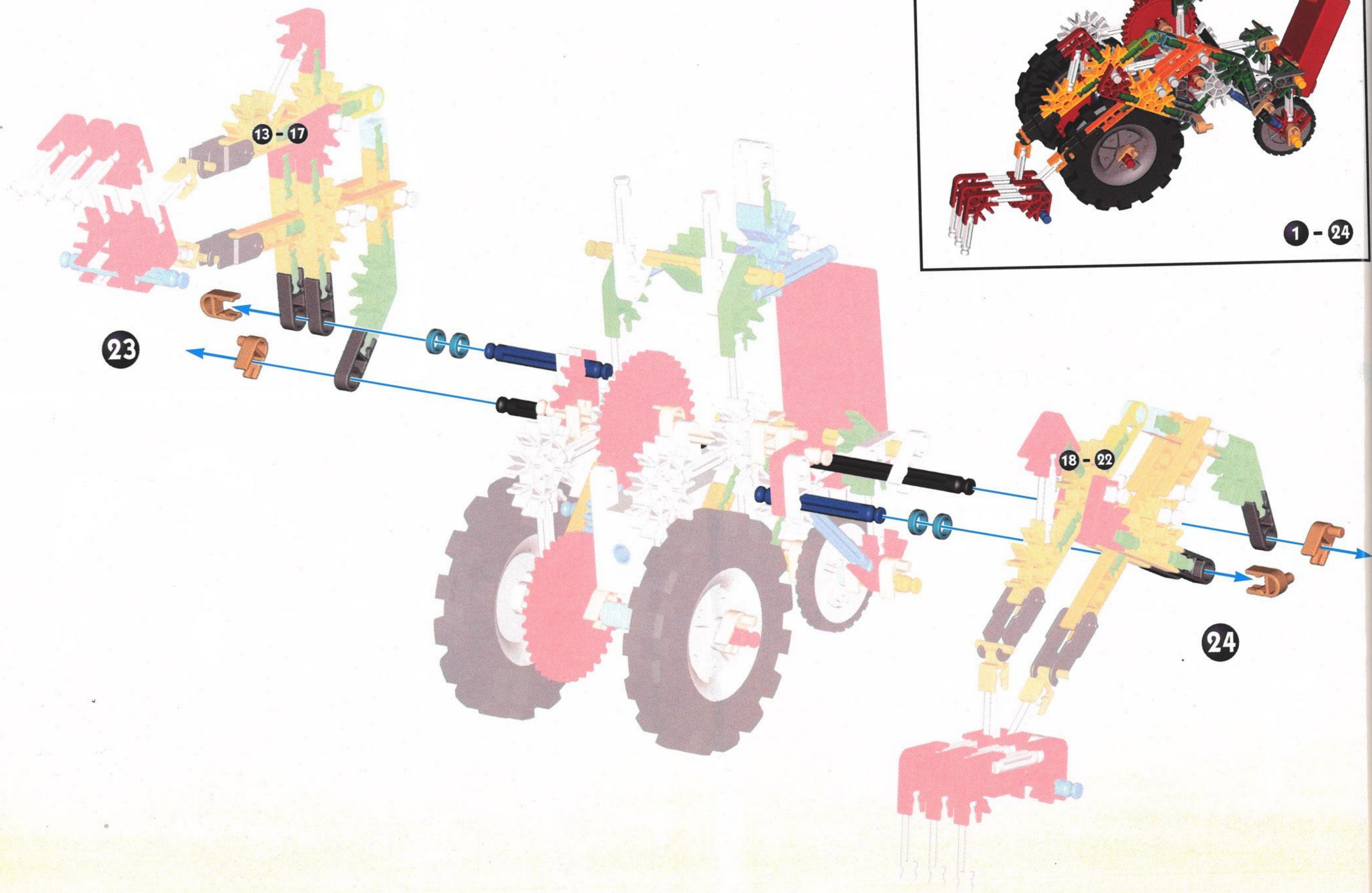

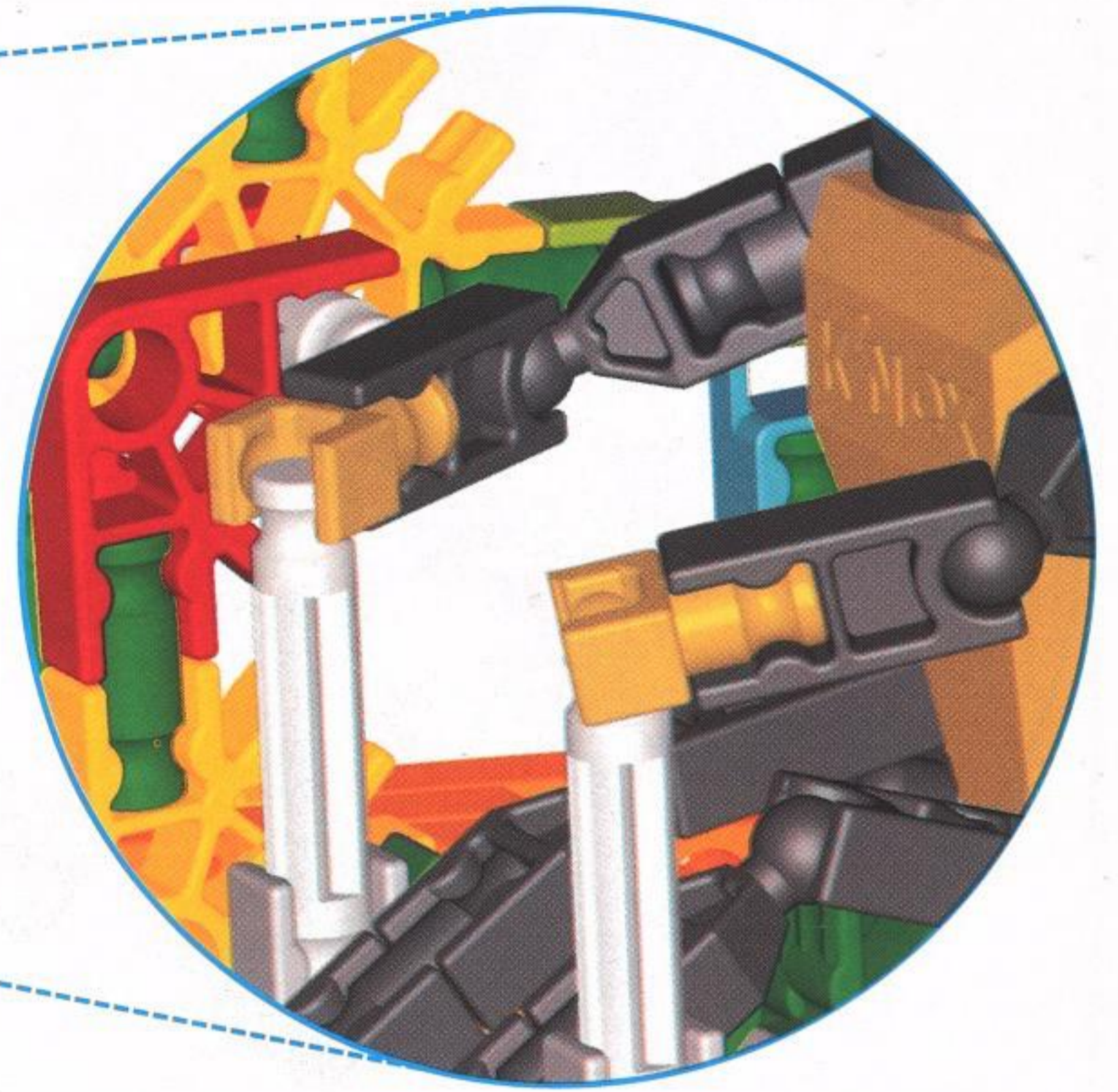

1 - 25

25



Clawbot

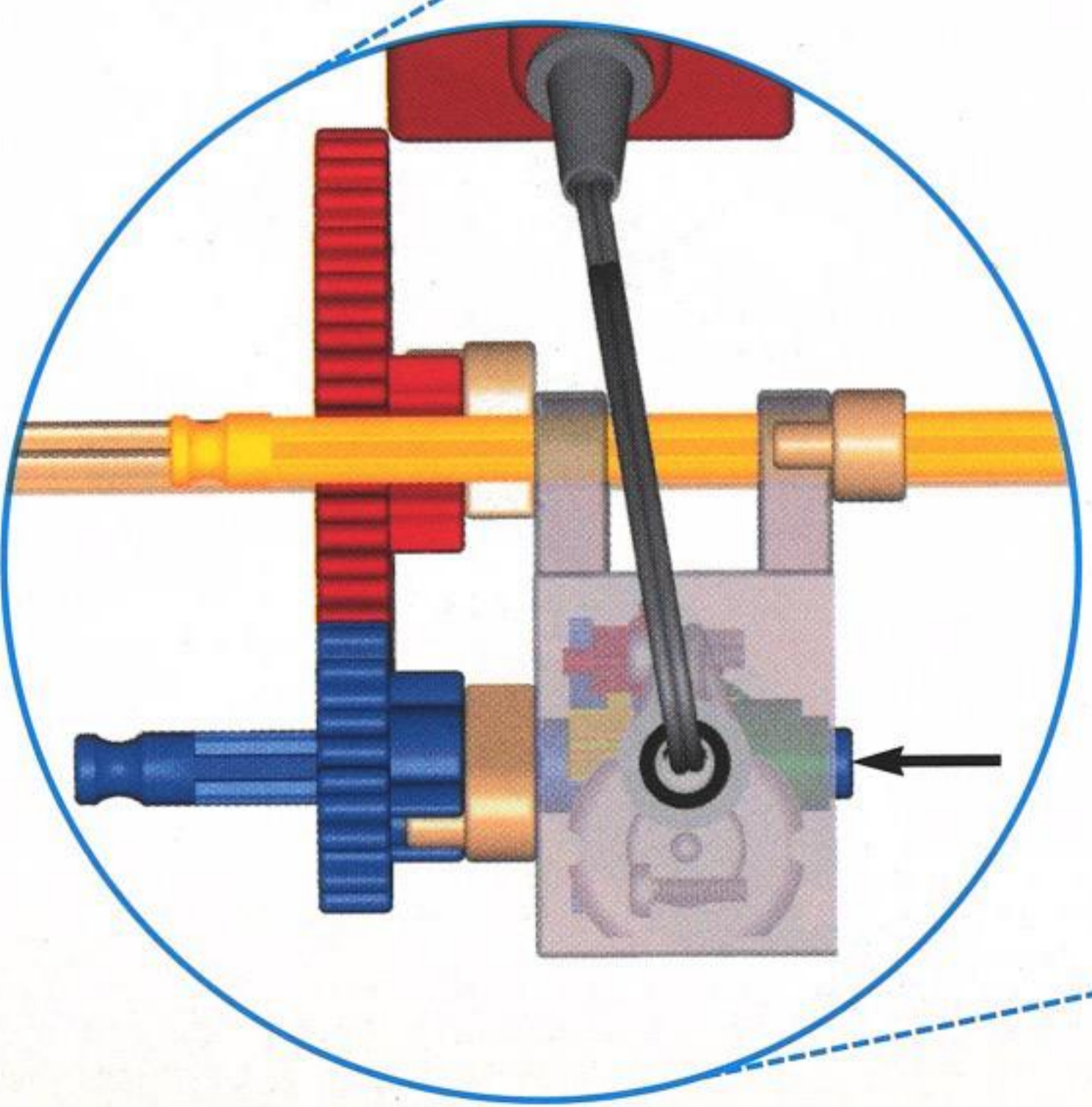
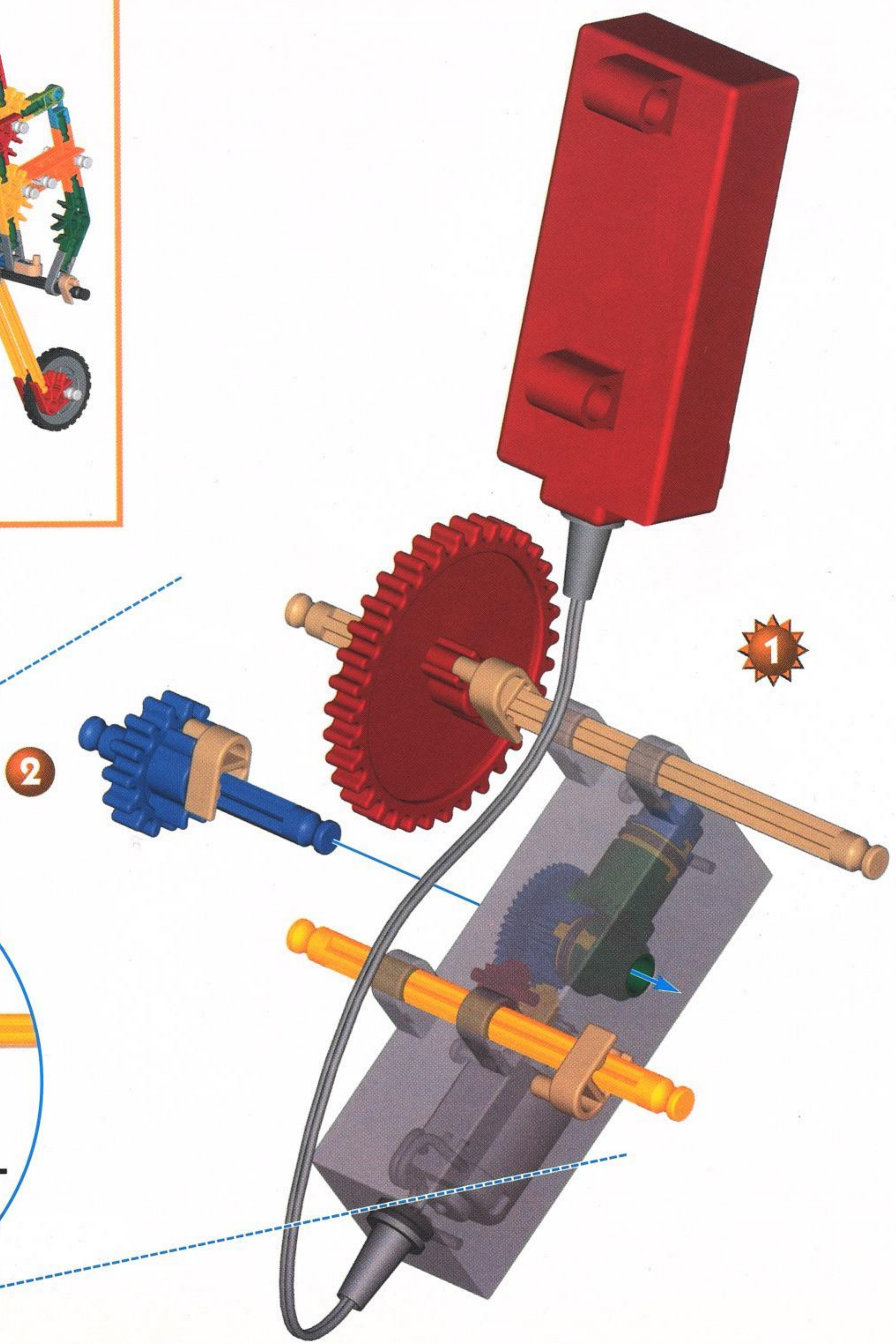
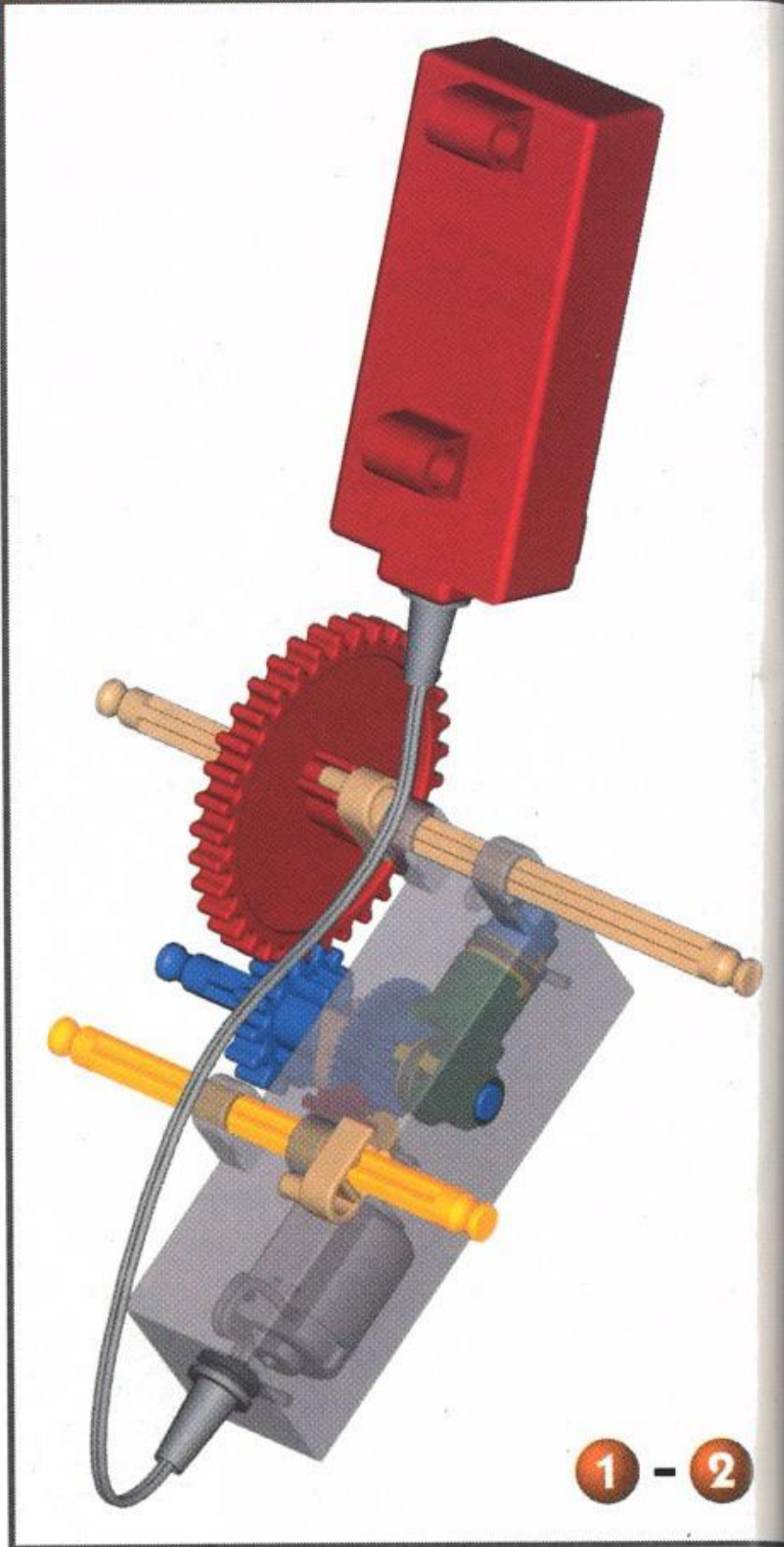
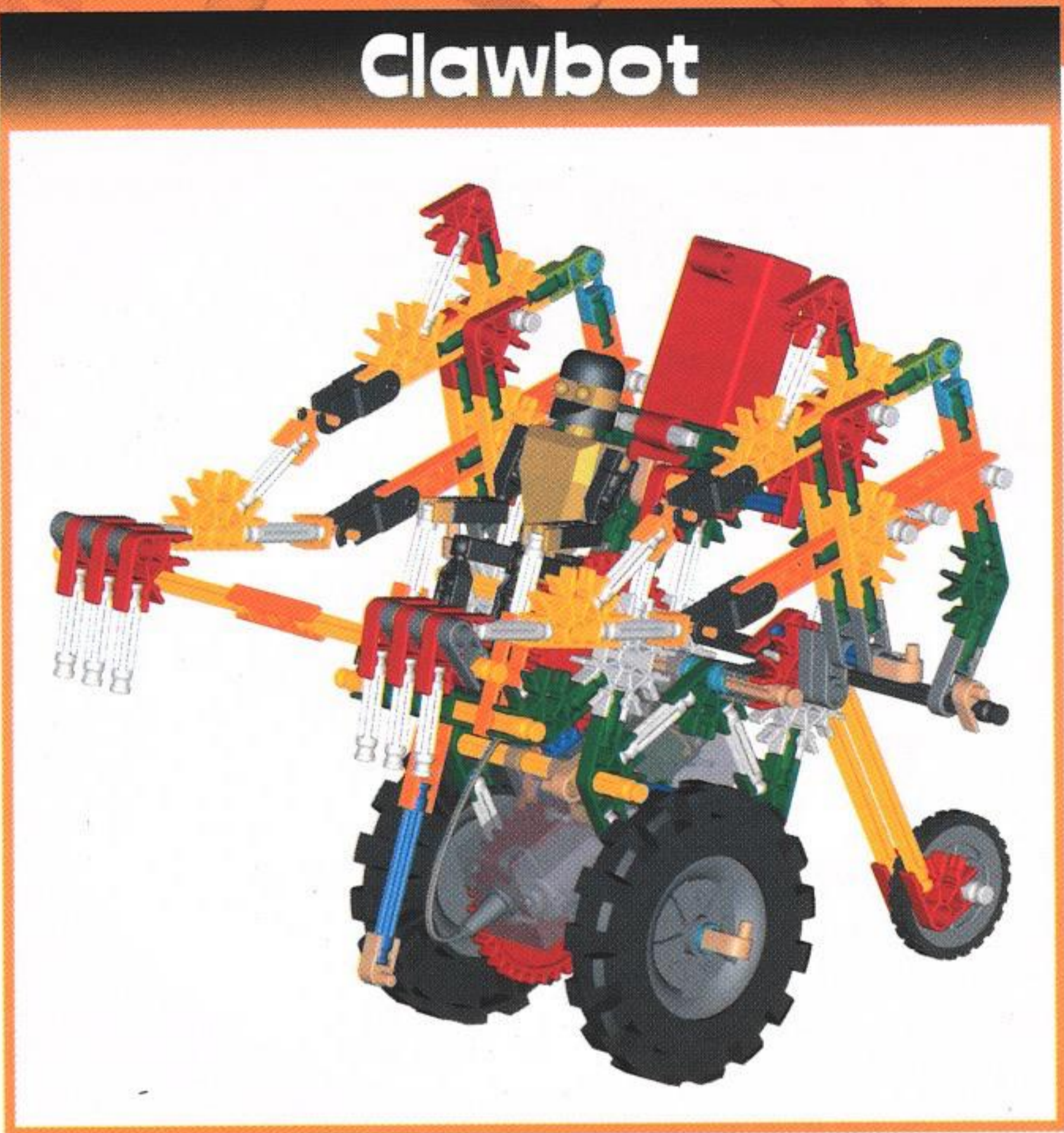



1 - 5

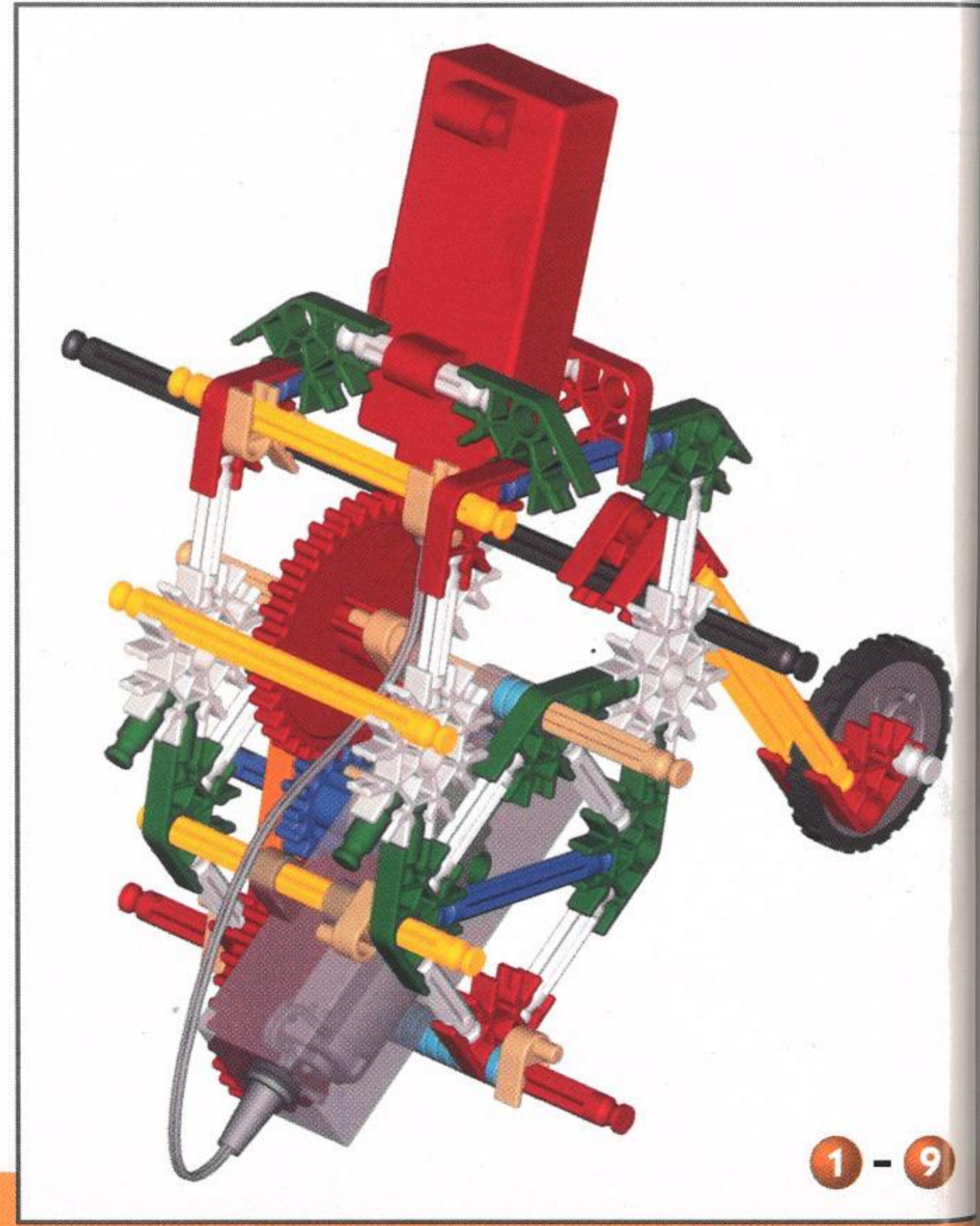
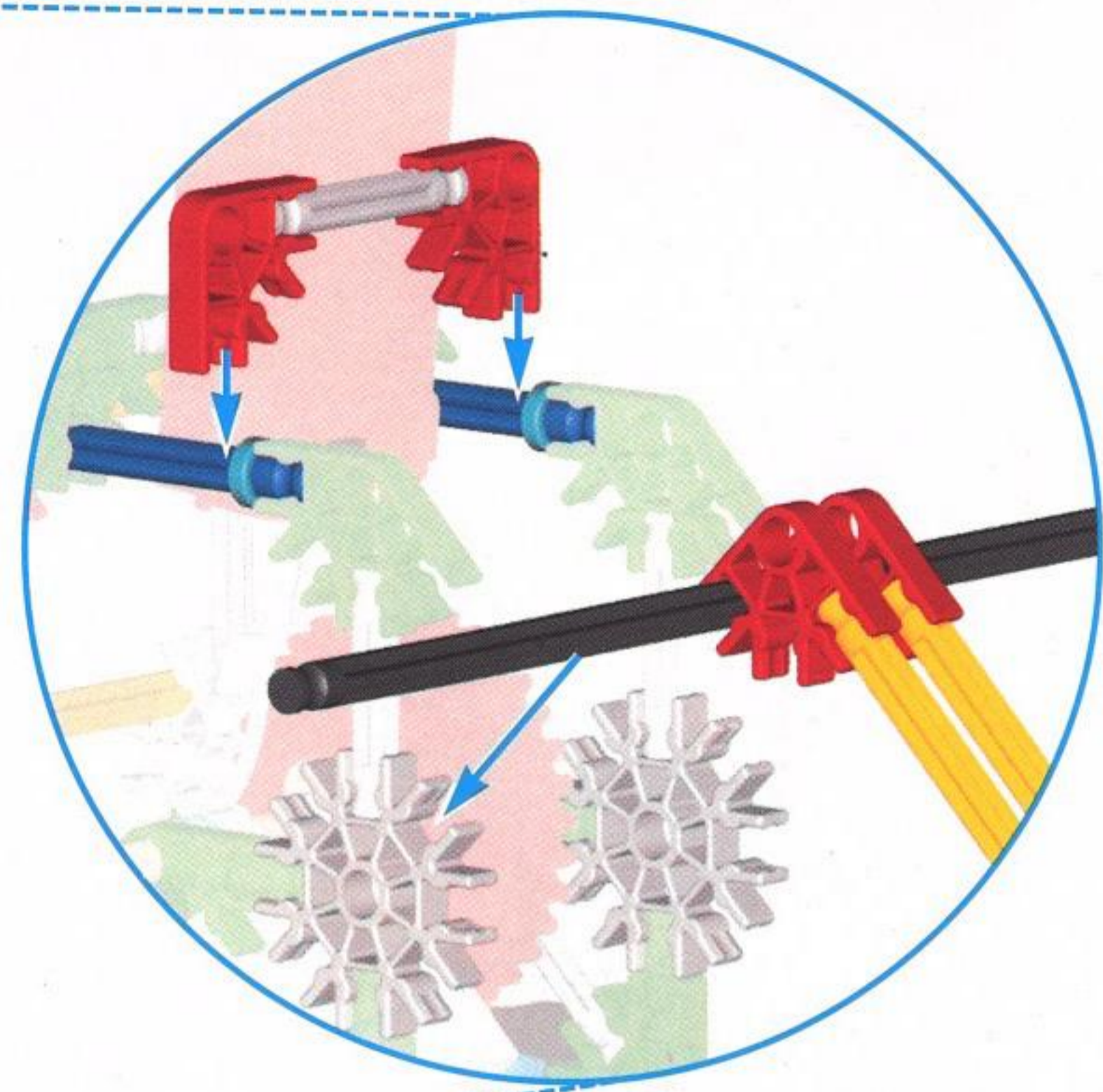
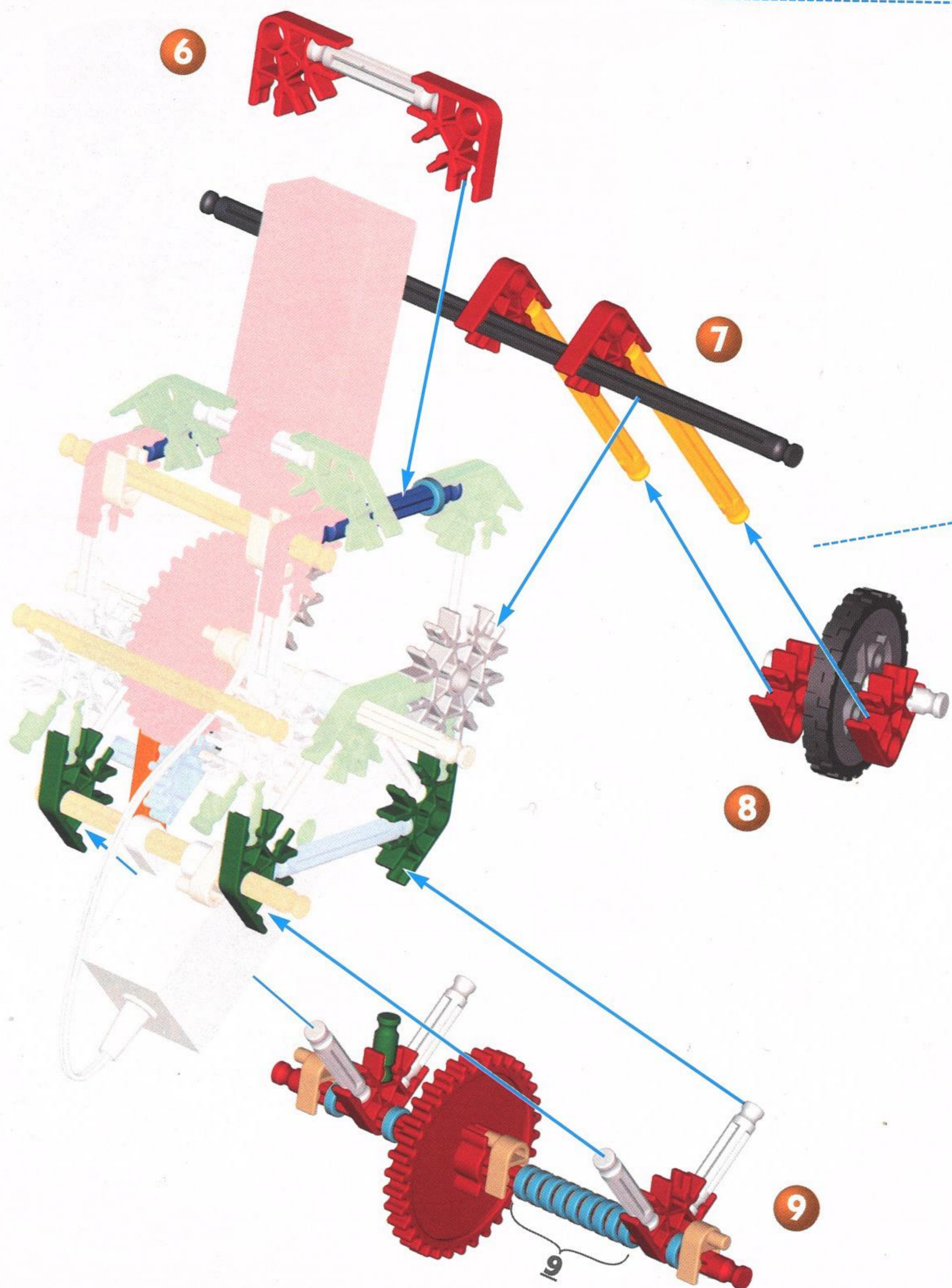

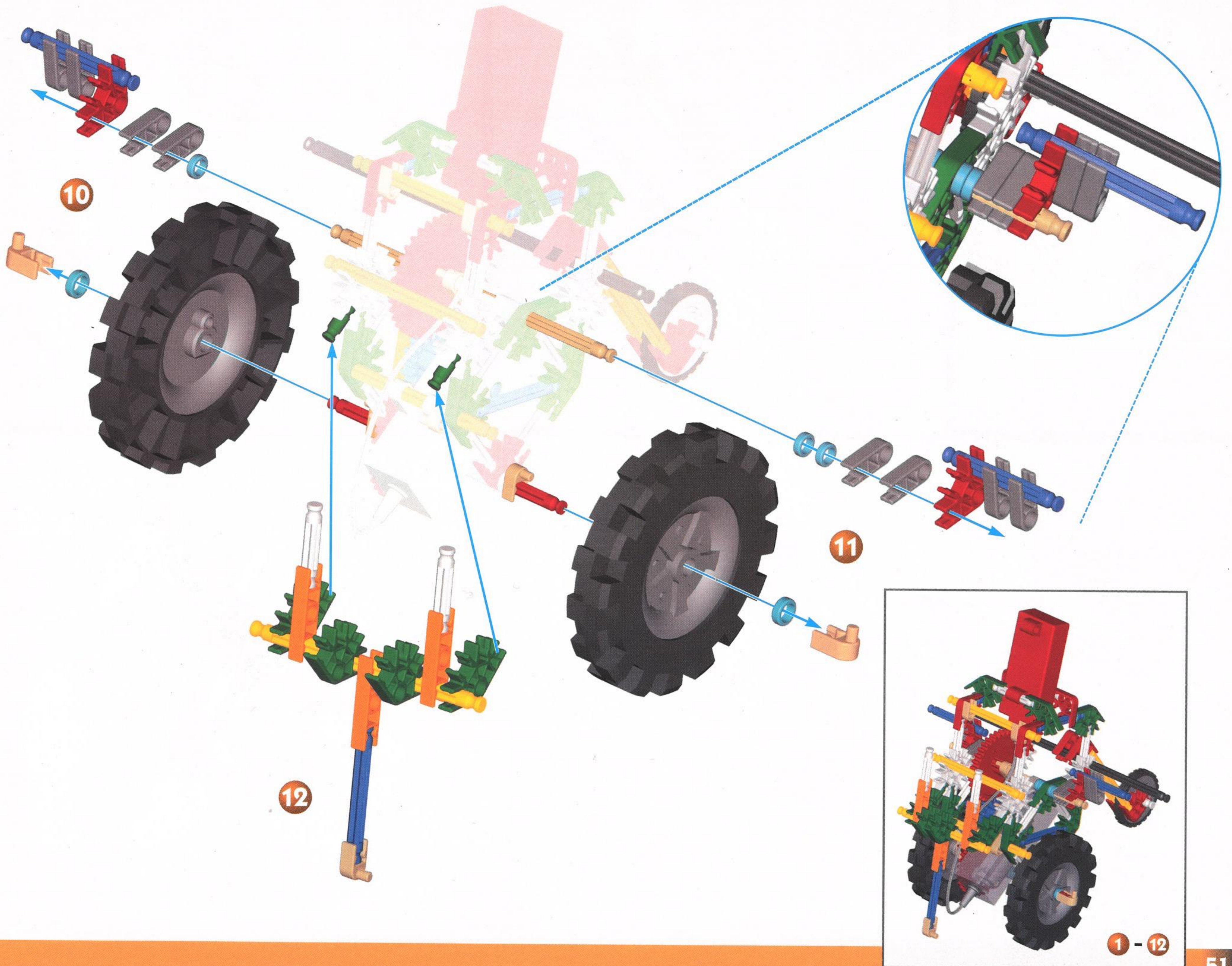



13

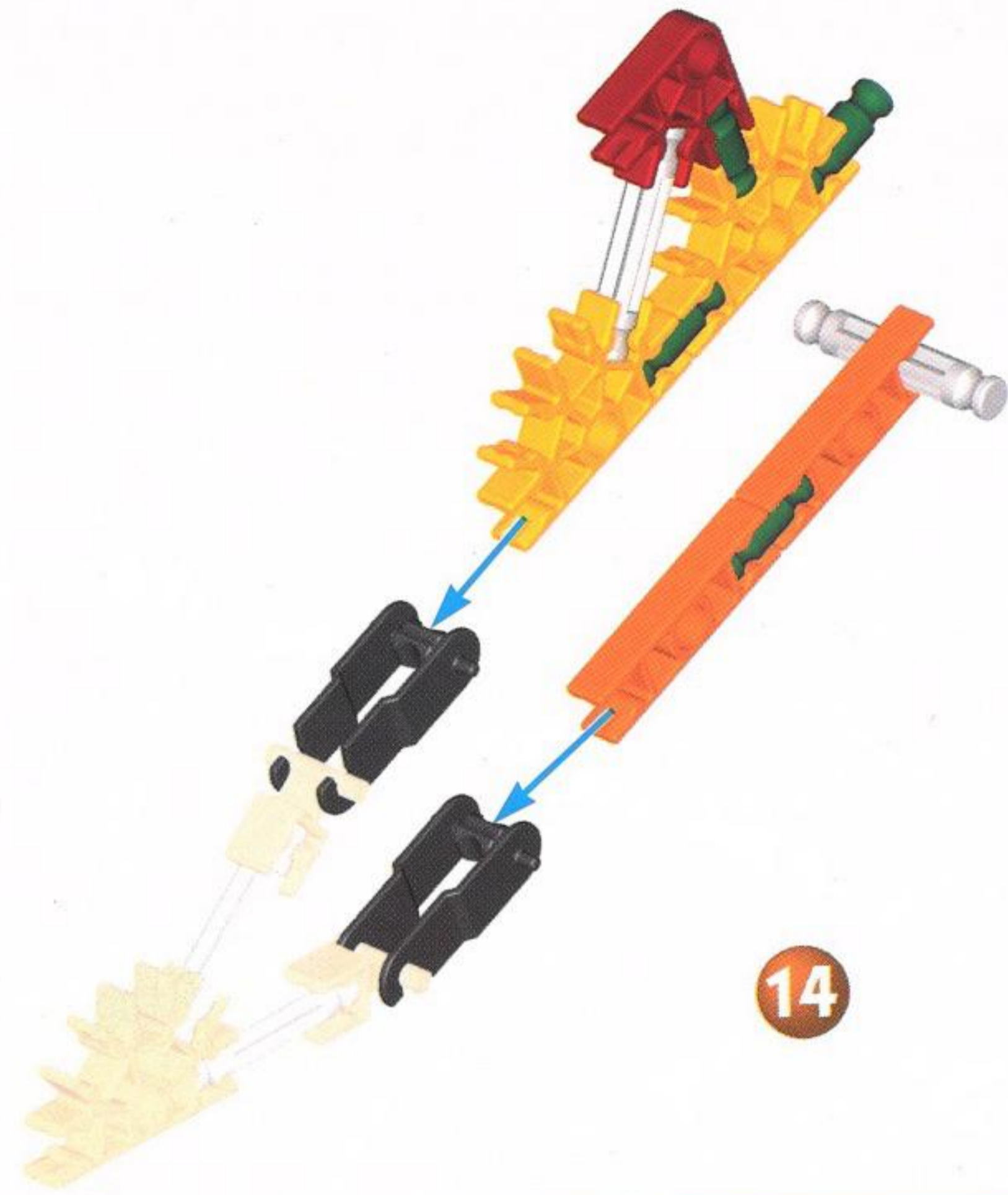

14

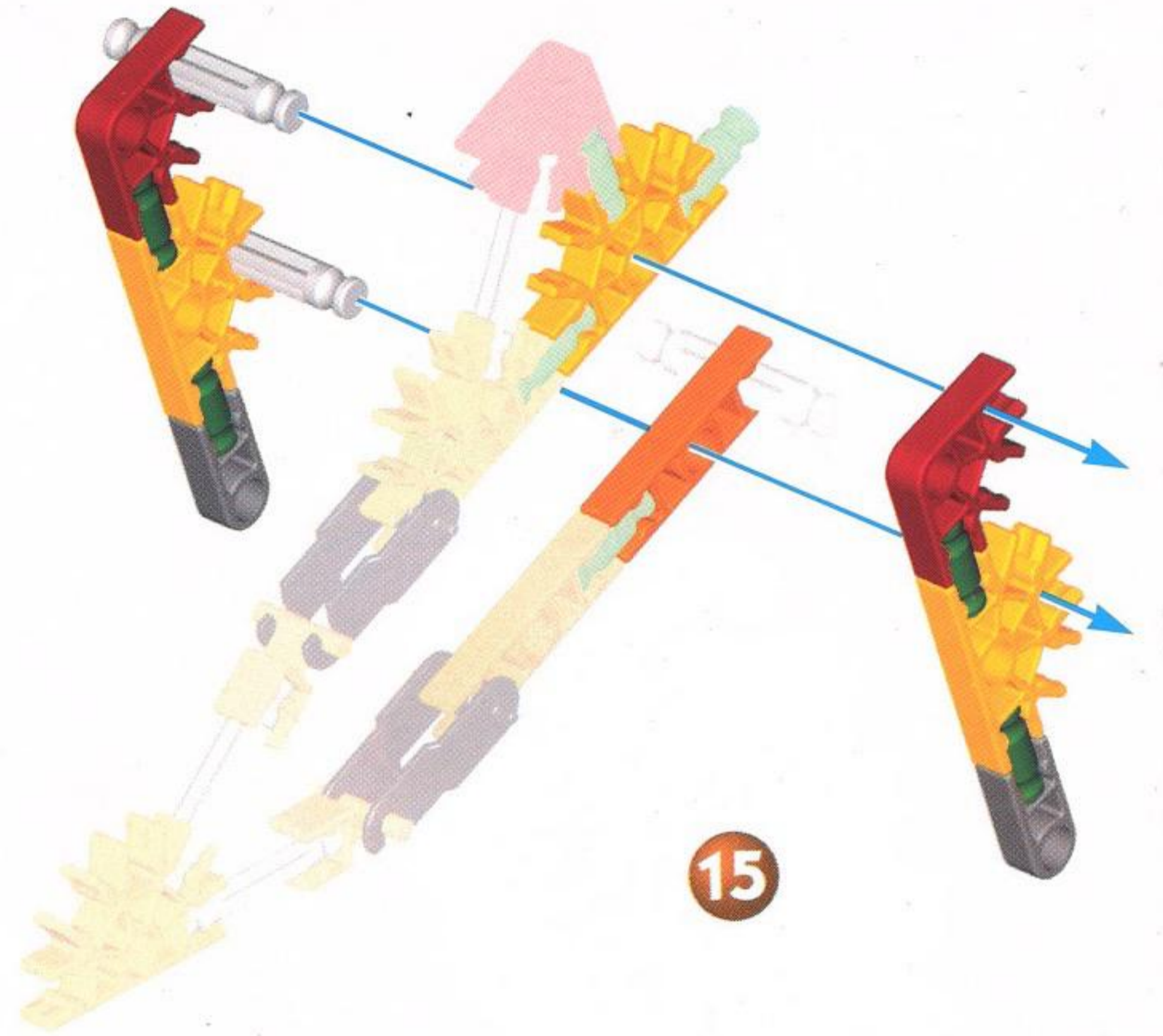

15



16

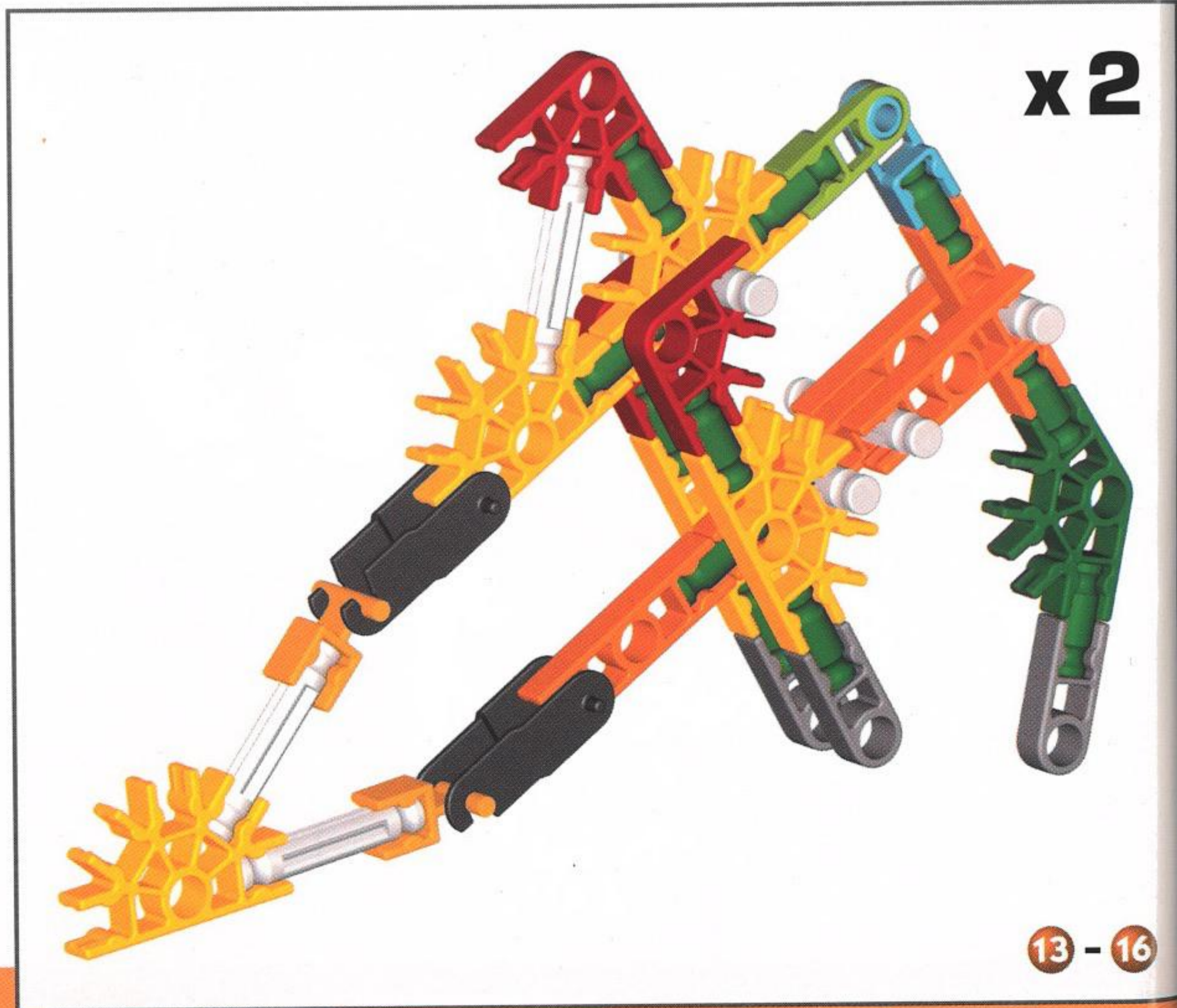

x 2

13 - 16



17

13 - 16

13 - 16

18

19

1 - 19

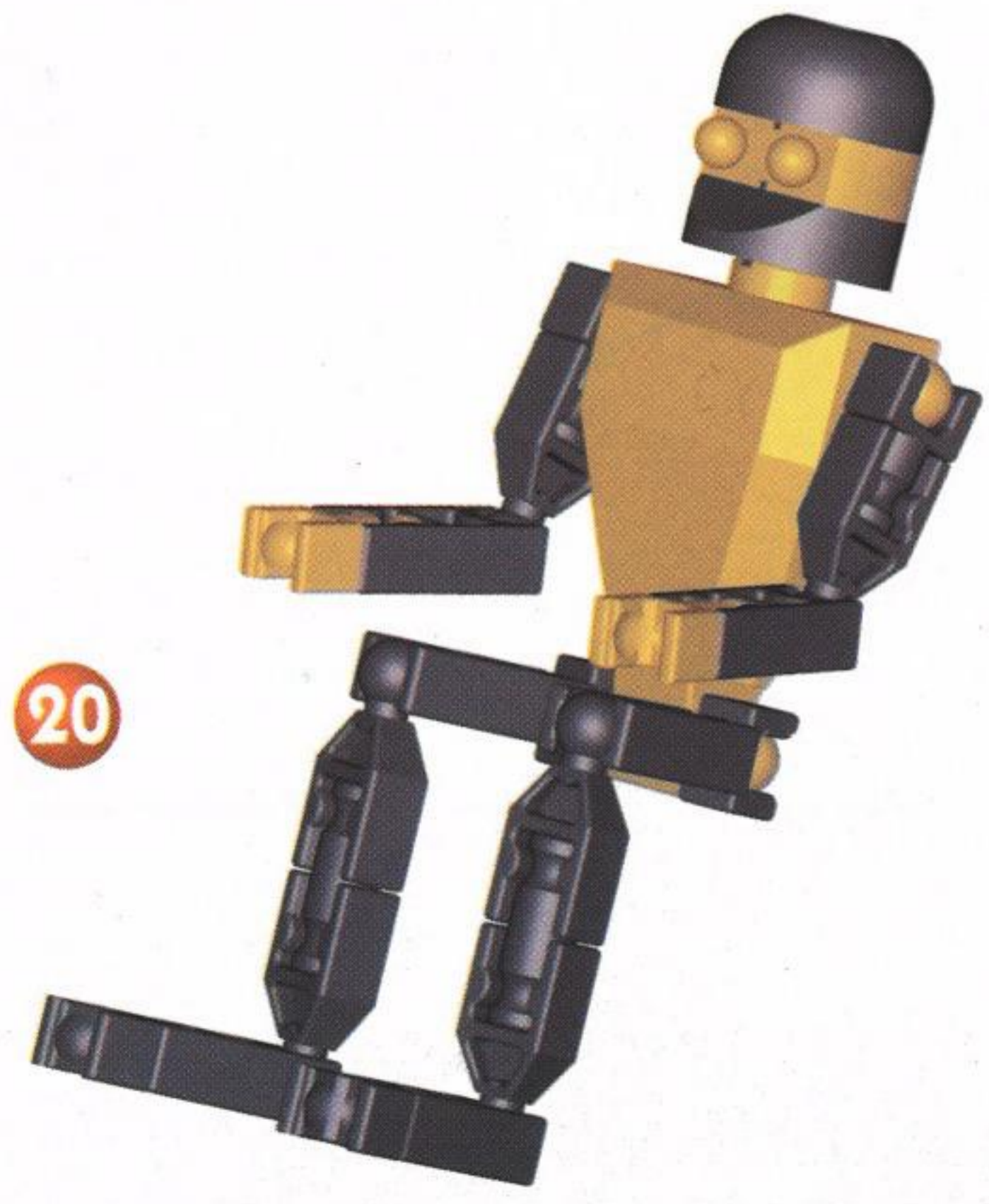
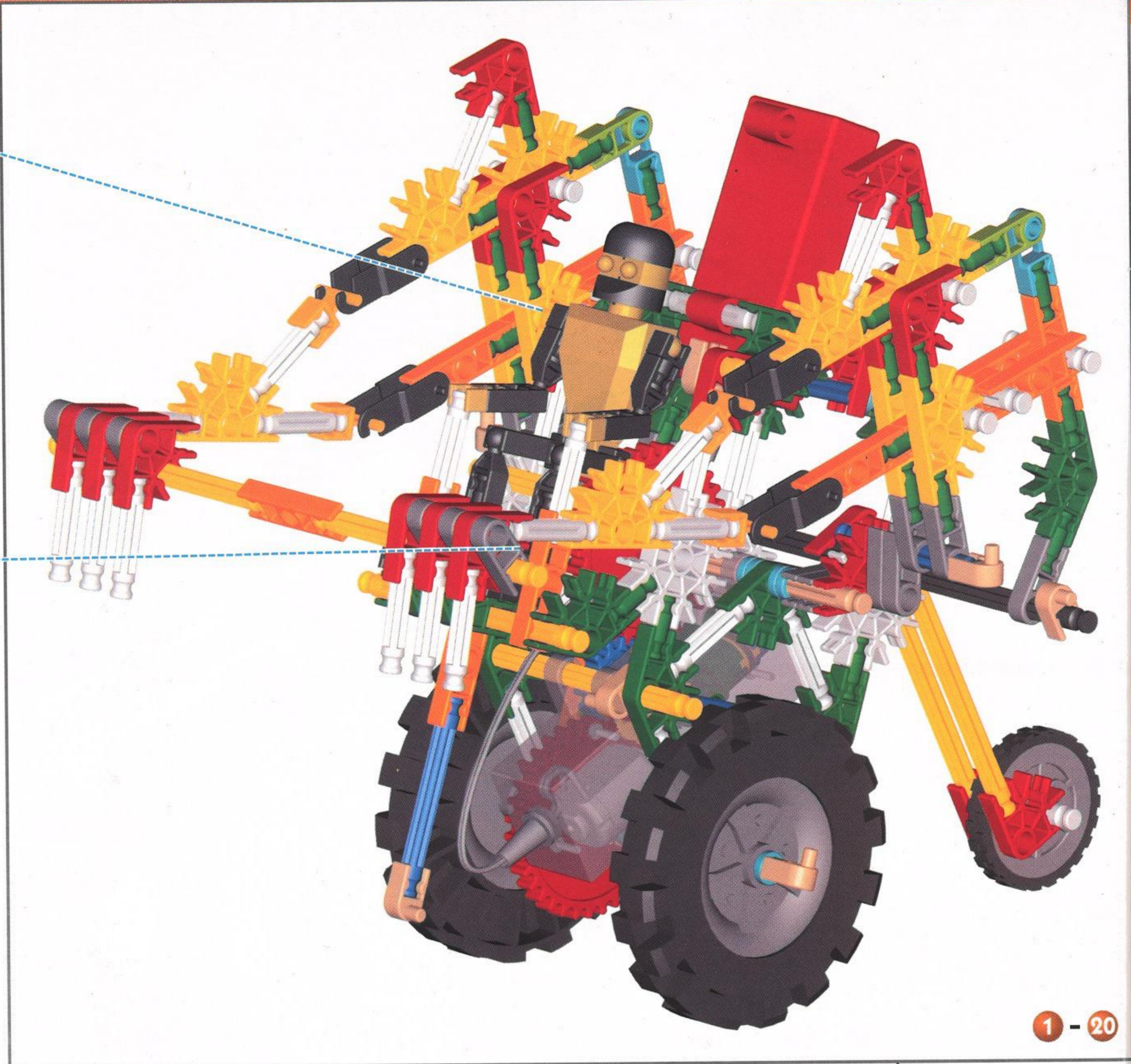
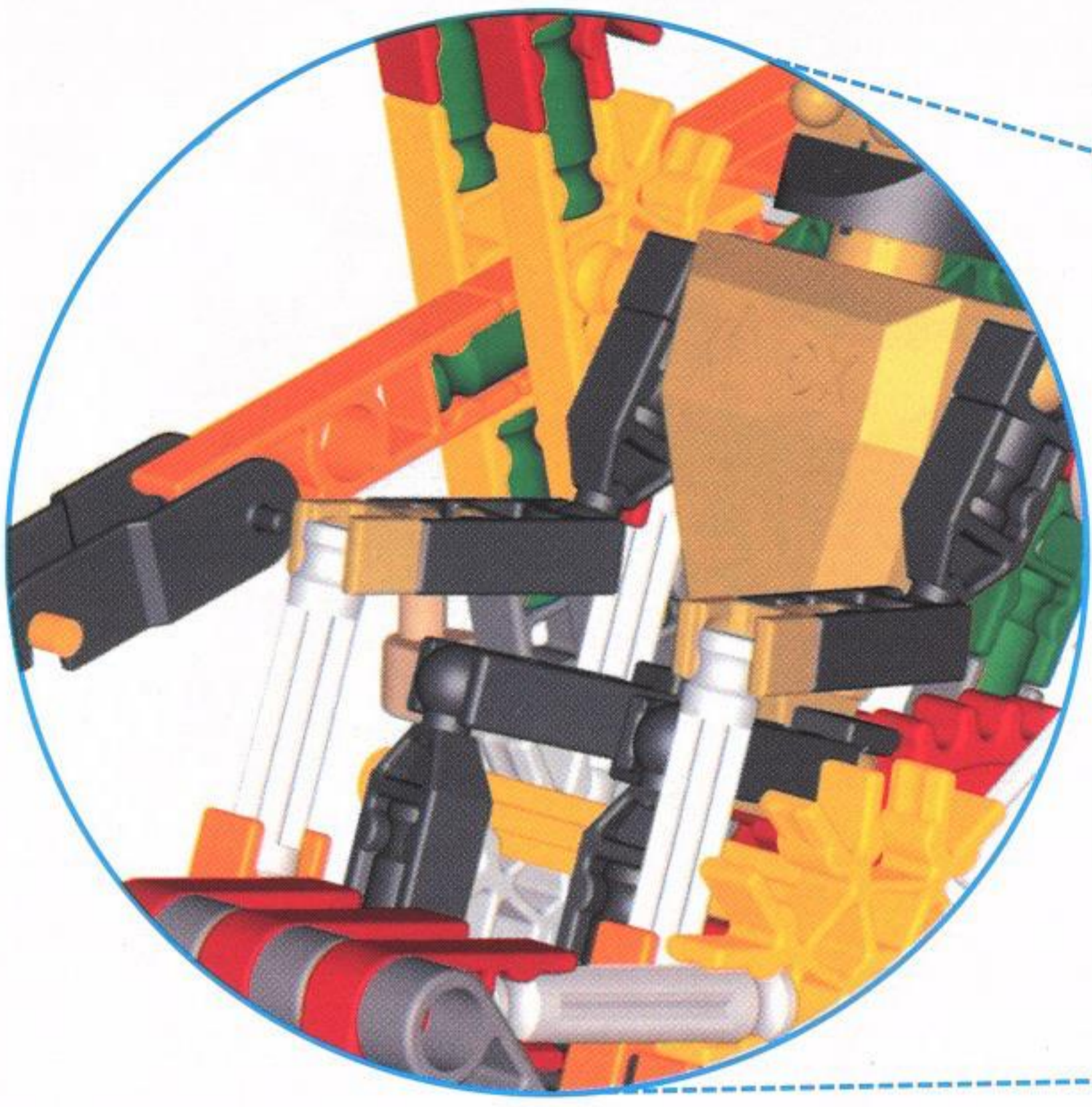

20

1 - 20

POWER PACK™

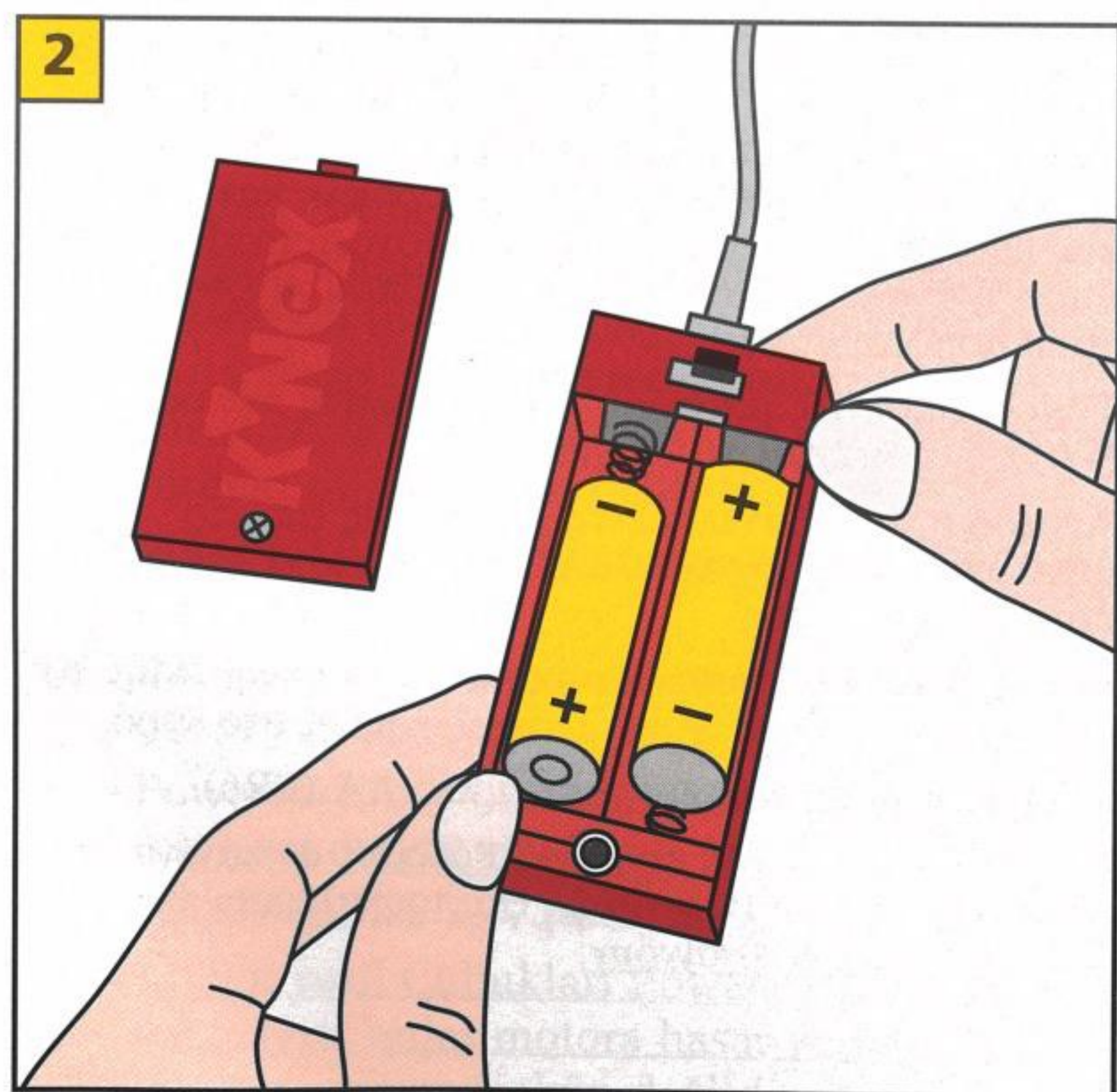
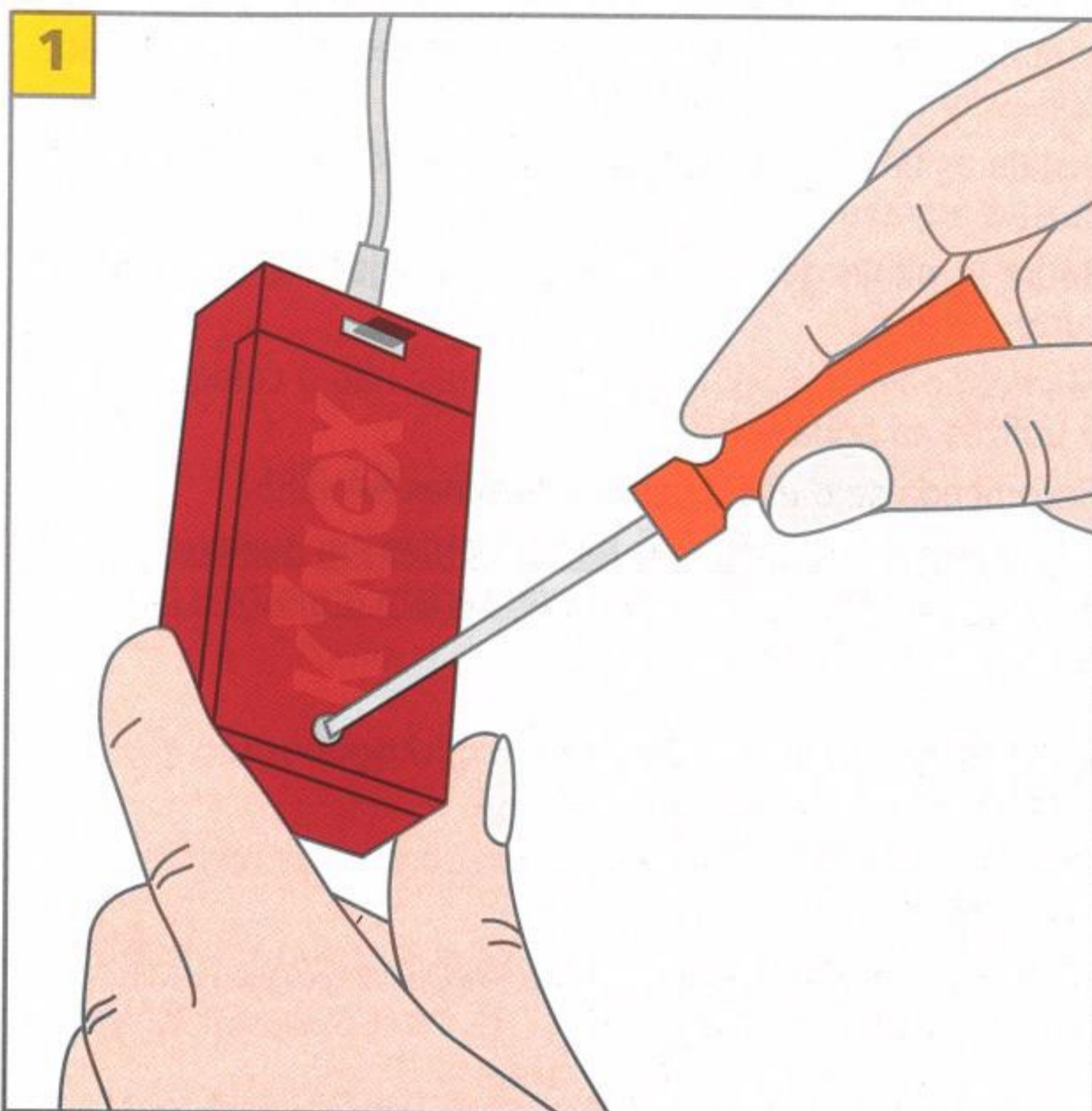

USA (GB) Keep this important information for future reference.

- Do not connect model to more than one PowerPack.™
- Remove rechargeable batteries from model before charging; they must be charged only under adult supervision.
- Non-rechargeable batteries must not be recharged.
- Do not mix different types of batteries; do not mix alkaline, standard (carbon-zinc), or rechargeable (nickel-cadmium) batteries. Do not mix new and used batteries. Only batteries of the same or equivalent type recommended should be used.
- Insert batteries with correct polarity (+/-) as shown.
- Remove exhausted batteries from model; do not short-circuit supply terminals.
- Keep PowerPack free of dust; do not immerse or use in water.
- Alkaline batteries AA (LR6) are recommended.
- Do not put small green Rods in any openings of the PowerPack; they will damage the motor, and cannot be removed.

F Conservez ces renseignements pour utilisation ultérieure.

- Ne branchez pas la maquette à plus d'un PowerPack.
- Enlevez les piles rechargeables de la maquette avant de les charger. Elles ne doivent être chargées que sous la supervision d'un adulte.
- Les piles non rechargeables ne doivent pas être rechargées.
- Ne mélangez pas les différents types de piles. Ne mélangez pas les piles alcalines, les piles standard (zinc-carbone) ni les piles rechargeables (nickel-cadmium). Ne mélangez pas des piles neuves et des piles usées. Il est recommandé de n'utiliser que des piles du même type ou de type équivalent.
- Insérez les piles en respectant la polarité (+/-), comme illustré.
- Enlevez les piles usées de la maquette et prenez soin de ne pas court-circuiter les bornes des piles.
- Maintenez le PowerPack propre et sans poussière. Ne l'immergez pas et ne l'utilisez pas dans l'eau.
- Il est recommandé d'utiliser des piles alcalines AA (LR6).
- Ne mettez pas les petites tiges vertes dans les trous du PowerPack, elles endommageraient le moteur et il n'est pas possible de les enlever.

I Conservate queste importanti informazioni per riferimenti futuri.

- Non collegate il modello a più di un PowerPack.
- Prima di ricaricare le pile ricaricabili, estraetele dal modello. Le pile vanno ricaricate solo sotto la supervisione di adulti.
- Le pile non ricaricabili non vanno ricaricate.
- Non mescolate tipi diversi di pile, come le pile alcaline, quelle normali (carbone-zinco) o quelle ricaricabili (nichel-cadmio). Non mescolate pile nuove ed usate. Vanno utilizzate solo le pile del tipo raccomandato o di tipo equivalente.
- Inserite le pile secondo la giusta polarità (+/-) come illustrato.

- Togliete dal modello le pile esaurite; non cortocircuitate i terminali dell'alimentatore.
- Non esponete alla polvere il PowerPack e non usatelo né immergetelo nell'acqua.
- Si raccomandano le pile alcaline AA (LR6).
- Non inserite le piccole aste verdi nelle aperture del PowerPack, in quanto non potranno venire rimosse e danneggeranno il motore.

D Diese wichtigen Informationen zum Nachschlagen gut aufbewahren.

- Das Modell an nicht mehr als ein PowerPack anschließen.
- Aufladbare Batterien vor dem Laden aus dem Modell entfernen; sie dürfen nur unter der Aufsicht von Erwachsenen geladen werden.
- Nicht aufladbare Batterien dürfen nicht wieder aufgeladen werden.
- Keine verschiedenen Batterientypen mischen; Alkalibatterien, Standard- (Kohlenstoff-Zink-) oder aufladbare (Nickel-Kadmium) Batterien nicht mischen. Keine neuen undgebrauchten Batterien mischen. Nur Batterien vom gleichen oder empfohlenen gleichwertigen Typ sollten verwendet werden.
- Die Batterien laut Abbildung mit der korrekten Polarität (+/-) einsetzen.
- Die leeren Batterien aus dem Modell nehmen; die Versorgungsklemmen nicht kurz schließen.
- Das PowerPack staubfrei halten; es darf nicht in Wasser eingetaucht oder benutzt werden.
- Wir empfehlen die Verwendung von Alkalibatterien AA (LR6).
- In keine der Öffnungen des PowerPack kleine grüne Stangen einsetzen; sie beschädigen den Motor und können nicht entfernt werden.

E Guarde esta importante información para consultarla más adelante.

- No conecte el modelo a más de un PowerPack.
- Saque las pilas recargables del modelo antes de cargarlas; solamente deben cambiarse con la supervisión de una persona adulta.
- Las pilas no recargables no deben recargarse.
- No mezcle diferentes tipos de pilas; no mezcle pilas alcalinas, estándar (carbone-zinc) o recargables (níquel-cadmio). No mezcle las pilas nuevas y las usadas. Solamente deben usarse pilas del mismo tipo recomendado o equivalente.
- Inserte las pilas con los polos (+/-) en posición correcta, tal como se indica.
- Saque del modelo las pilas gastadas; asegúrese de no provocar un cortocircuito en el terminal de alimentación.
- Mantenga el PowerPack libre de polvo; no lo sumerja ni lo use en agua.
- Se recomiendan baterías alcalinas AA (LR6).
- No meta las varillas verdes pequeñas en los orificios del PowerPack, ya que dañarían el motor y no se podrían sacar.

S Behåll denna viktiga information för framtida bruk.

- Koppla inte modellen till mer än en PowerPack.
- Avlägsna laddningsbara batterier från modellen före laddning; de måste laddas under översikt av vuxna.
- Batterier som inte kan laddas om får inte laddas om.
- Kombinera inte olika sorters batterier; blanda inte alkaliska batterier, standardbatterier (kol/zink) eller laddningsbara batterier (nickel/kadmium). Kombinera inte nya och använda batterier. Du bör endast använda batterier av den typ som rekommenderats, eller likvärdig typ.
- Sätt in batterierna med korrekt polaritet (+/-) enligt anvisning.
- Avlägsna nedgångna batterier från modellen; undvik kortslutning vid kontakterna.
- Se till att PowerPack inte blir dammig; doppa inte och använd inte i vatten.
- Alkaliska batterier AA (LR6) rekommenderas.
- Placera inga små gröna stänger i några som helst öppningar i PowerPack; de skadar motorn och kan inte avlägsnas.

DK Gem disse vigtige oplysninger som fremtidig reference.

- Modellen må ikke forbindes med mere end én PowerPack.
- Tag genopladelige batterier ud af modellen inden de lades op. De må kun oplades under tilsyn af voksne.
- Ikke-genopladelige batterier må aldrig genoplades.
- Batterityperne må ikke blandes. Bland aldrig alkaliske, standard (kulstof-zink) eller genopladelige (nikkel-cadmium) batterier. Bland aldrig nye og brugte batterier. Der bør kun benyttes batterier af samme eller anbefalet tilsvarende type.
- Sæt batterierne i ifølge den viste polaritet (+/-).
- Fjern udslidte batterier fra modellen; polerne må ikke kortsluttes.
- PowerPack skal holdes fri af støv og må ikke dyppes eller bruges i vand.
- Alkaliske batterier AA (LR6) anbefales.
- De små grønne stænger må ikke stikkes i nogen af åbningerne på PowerPack. De vil ødelægge motoren og kan ikke tages ud.

N Ta vare på disse viktige opplysningene.

- Modellen skal ikke koples til mer enn én PowerPack.
- Ta oppladbare batterier ut av modellen før batteriene lades opp. Opplading av batterier må kun skje under oppsyn av voksne.
- Prøv ikke å lade opp batterier som ikke er oppladbare.
- Bruk ikke batterier av ulike typer samtidig. Alkaline-batterier, standard (karbon-sink) batterier eller oppladbare batterier (nikkel-kadmium) må ikke blandes. Nye og brukte batterier bør heller ikke brukes samtidig. Batteriene bør kun

være av samme type eller tilsvarende type.

- Sett batteriene inn med riktig polaritet (+/-), slik som vist.
- Ta oppbrukte batterier ut av modellen. Pass på at du ikke kortslutter forsyningsterminalene.
- Sørg for at PowerPack er fri for støv. PowerPack skal ikke senkes eller brukes i vann.
- Alkaline-batterier AA (LR6) anbefales.
- Du må ikke stikke små grønne stenger inn i noen av åpningene på PowerPack. Stengene vil ikke kunne fjernes og kan skade motoren.

SF Säilytä nämä tärkeät tiedot myöhempää tarvetta varten.

- Älä liitä mallia useampaan kuin yhteen voimayksikköön.
- Poista ladattavat paristot mallista ennen niiden latausta; ne on ladattava ainoastaan aikuisten valvonnan alla.
- Ei-ladattavia paristoja ei saa ladata uudelleen.
- Älä sekoita eri tyyppisiä paristoja; älä sekoita keskenään alkaliparistoja, tavallisia (hiili-sinkki) tai ladattavia (nikkeli-kadmium) paristoja. Älä käytä sekaisin uusia ja käytettyjä paristoja. Vain saman tai vastaavan tyyppisiä paristoja saa käyttää.
- Pane sisään paristot polaarisesti oikein (+/-) kuten näytetään.
- Poista kuluneet paristot mallista; älä aiheuta oikosulkuu syöttöliittimiin.
- Pidä voimayksikkö pölyvapaana; älä upota sitä veteen tai käytä sitä vedessä.
- Suosittelemme alkaliparistoja AA (LR6).
- Älä pane pieniä vihreitä sauvoja mihinkään voimayksikön reikään, ne vahingoittavat moottoria ja niitä ei voi poistaa.

NL Bewaar deze belangrijke informatie voor later.

- Sluit het model niet op meer dan één PowerPack aan.
- Verwijder de oplaadbare batterijen uit het model om ze op te laden; ze mogen alleen onder toezicht van een volwassene worden opgeladen.
- Niet-oplaadbare batterijen mogen niet opnieuw worden opgeladen.
- Verschillende soorten batterijen niet door elkaar gebruiken; geen alkali-, standaard (koolzink) of oplaadbare (nikkel-cadmium) batterijen door elkaar gebruiken. Geen nieuwe en gebruikte batterijen door elkaar gebruiken. Alleen batterijen van hetzelfde of soortgelijk aanbevolen type mogen worden gebruikt.
- Plaats batterijen met de juiste polariteit (+/-) zoals aangegeven.
- Lege batterijen uit het model halen; voedingsklemmen niet kortsluiten.
- Het PowerPack stofvrij houden; niet onderdompelen of in water gebruiken.
- Alkali-batterijen AA (LR6) worden aanbevolen.
- Plaats geen groene staafjes in de openingen van het PowerPack; zij zouden de motor beschadigen en kunnen niet worden verwijderd.

P Guarda estas importantes instruções para referência futura.

- Não ligue o modelo a mais do que um PowerPack.
- Retira as pilhas recargáveis do modelo antes de iniciar a recarga; as pilhas só deverão ser recargadas na presença de um adulto.
- Não se deve tentar fazer a recarga de pilhas não recargáveis.
- Não misture pilhas de tipos diferentes. Não junte as pilhas alcalinas com as normais (de carvão e zinco) ou com as pilhas recargáveis (de níquel-cádmio). Não misture as pilhas novas com as gastas. Apenas deverão ser utilizadas as baterias do tipo recomendado ou equivalente.
- Instala as baterias na posição correcta (pólos + e -) como mostra a gravura.
- Retira as pilhas gastas do modelo; não ligue os terminais em curto-circuito.
- Mantém o PowerPack limpo de poeiras; não o coloques nem o utilizes na água.
- Recomenda-se o uso de pilhas alcalinas AA (LR6).
- Não coloques as pequenas hastes verdes em qualquer abertura do PowerPack; elas danificariam o motor e não poderiam ser removidas.

G Φυλάξτε αυτές τις σημαντικές πληροφορίες για μελλοντική χρήση.

- Μη συνδέετε το μοντέλο με περισσότερα από ένα PowerPack.
- Αφαιρείτε τις επαναφορτιζόμενες μπαταρίες από το μοντέλο πριν τις φορτίσετε. Πρέπει να φορτίζονται μόνο υπό την επίβλεψη ενηλίκου.
- Μη επαναφορτιζόμενες μπαταρίες δεν πρέπει να επαναφορτίζονται.
- Μην αναμειγνύετε διαφορετικούς τύπους μπαταριών. Μην αναμειγνύετε αλκαλικές, συνήθεις (άνθρακα-ψευδαργύρου), ή επαναφορτιζόμενες (νικελίου-καδμίου) μπαταρίες. Μην αναμειγνύετε καινούριες και μεταχειρισμένες μπαταρίες. Μόνο μπαταρίες του ίδιου ή ανάλογου συνιστώμενου τύπου πρέπει να χρησιμοποιούνται.
- Τοποθετήστε τις μπαταρίες με τη σωστή πολικότητα (+/-) όπως δείχνει το σχήμα.
- Αφαιρείτε τις εξαντλημένες μπαταρίες από το μοντέλο. Μη βραχυκυκλώνετε τους ακροδέκτες παροχής ρεύματος.
- Διατηρείτε το PowerPack μακριά από σκόνη. Μην το βυθίζετε ούτε να το χρησιμοποιείτε μέσα στο νερό.
- Συνιστώνται αλκαλικές μπαταρίες AA (LR6).
- Μη βάλετε τις μικρές πράσινες Ράβδους σε κανένα από τα ανοίγματα του PowerPack. Θα προκαλέσουν βλάβη στο μοτέρ, και δε βγαίνουν.

J 以下は重要な注意事項です。今後の参照用に保管してください。

- モデルは複数のPowerPackに接続しないでください。
- 充電用バッテリーは、モデルから取り外した後で充電してください。バッテリーの充電は、大人が見ているところで行ってください。
- 充電用でないバッテリーは、決して充電しないでください。
- アルカリバッテリー、通常のバッテリー（炭素鉛）、充電用バッテリー（ニッカド=ニッケルカドミウム）など、異なる種類のバッテリーを一緒に使用しないでください。また、新しいバッテリーと古いバッテリーを一緒に使用しないでください。推奨されている同一または同等のバッテリーのみを使用してください。
- バッテリーは、電極（+および-極）の向きを正しく確認して挿入してください。
- 使い古したバッテリーはモデルから取り外し、電源ターミナルの漏電を避けてください。
- PowerPackに埃が付かないようにしてください。また、水に浸したり、水中で使用しないでください。
- アルカリバッテリー AA (LR6) の使用をお勧めします。
- グリーンのロッドは、PowerPackの開口部に差し込まないでください。これらのロッドはモーターを損傷し、後で取り外しできません。

TR Bu önemli bilgiyi ileride de kullanmak için saklayın.

- Modeli birden fazla PowerPack e bağlamayın.
- Şarj edilebilen pilleri modelden çıkardıktan sonra şarj edin; şarj işlemi ancak yetişkin bir kişinin gözetimi altında yapılmalıdır.
- Şarj edilemeyen normal piller şarj edilmemelidir.
- Değişik türden olan pilleri birbirine karıştırmayın; alkalın, standart (karbon-çinko), veya şarj edilebilen (nikel-kadmiyum) pilleri birbirine karıştırmayın. Yeni ve eski pilleri birbirine karıştırmayın. Sadece tavsiye edilen veya benzeri türdeki piller kullanılmalıdır.
- Pillerin kutuplarını (+/-) gösterildiği şekilde doğru olarak takın.
- Bitmiş pilleri modelden çıkarın; kutupları kısa devre yaptırmayın.
- PowerPack'in tozlanmamasına dikkat edin; suyun içine sokmayın veya suda kullanmayın.
- Alkalın piller AA (LR6) tavsiye edilir.
- Küçük yeşil Çubukları PowerPack'in oyuklarına sokmayın; onlar motora hasar verirler ve sonra da çıkarılmaları mümkün değildir.

CHI 保留這份重要資料供今後參考。

- 不要將模型連接到一個以上的電池盒 (PowerPack™) 上。
- 在電池充電前，先將可充電電池從模型上取出，並只能在成人指導下充電。
- 非可充電型電池不能充電。
- 不要將不同型式的電池混合使用，不要混合使用鹼性的、標準的 (碳 - 鋅)，或可充電的 (鎳 - 鎘) 電池。不要混合使用新舊電池。應只用和推薦的相同或相當型式的電池。
- 裝電池時要按照圖示的正確極性 (+/-) 裝入。
- 電池耗盡後應從模型上取出，不要將供電端短路。
- 電池盒 (PowerPack) 上不要有灰塵，也不要浸入水中或在水中使用。
- 推薦使用鹼性電池 (LR6)。
- 不要將綠色小桿插入電池盒 (PowerPack) 的任何孔內。它們會損壞馬達，而且會再也拿不出來。

IL שמור על מידע חשוב זה, לצורך עיון בעתיד.

- אל תחבר את הדגם ליותר מ-PowerPack אחד.
- הוצא מהדגם סוללות הניתנות לטעינה לפני הטעינה. יש לטעון סוללות בפיקוח אדם מבוגר בלבד.
- אין לטעון סוללות שאינן ניתנות לטעינה.
- על תערבב סוגים שונים של סוללות. אל תערבב סוללות מסוג אלקלין, סוללות סטנדרנטיות (פחם-אבץ) או סוללות הניתנות לטעינה (ניקל-קדמיום). אל תערבב סוללות חדשות ומשומשות. השתמש אך ורק בסוללות מהסוג המומלץ או מסוג בעל תכונות זהות.
- הכנס את הסוללות בכיוון הנכון (+/-), כפי שמראים בתמונה.
- הוצא סוללות מרוקנות מהדגם. אל תגרורם לקצר במגע ספק הכוח.
- שמור על ה-PowerPack, כך שיהיה נקי מאבק. אל תכניסו אל תוך מים ואל תשתמש בו בתוך מים.
- מומלץ להשתמש בסוללות מסוג אלקלין (LR6)
- אל תכניס מוטות ירוקים קטנים אל תוך פתחים כלשהם ב-PowerPack. מוטות אלה יגרמו נזק למנוע, ולא ניתן להוציאם.

K'NEX®
Creative Construction for Kids™

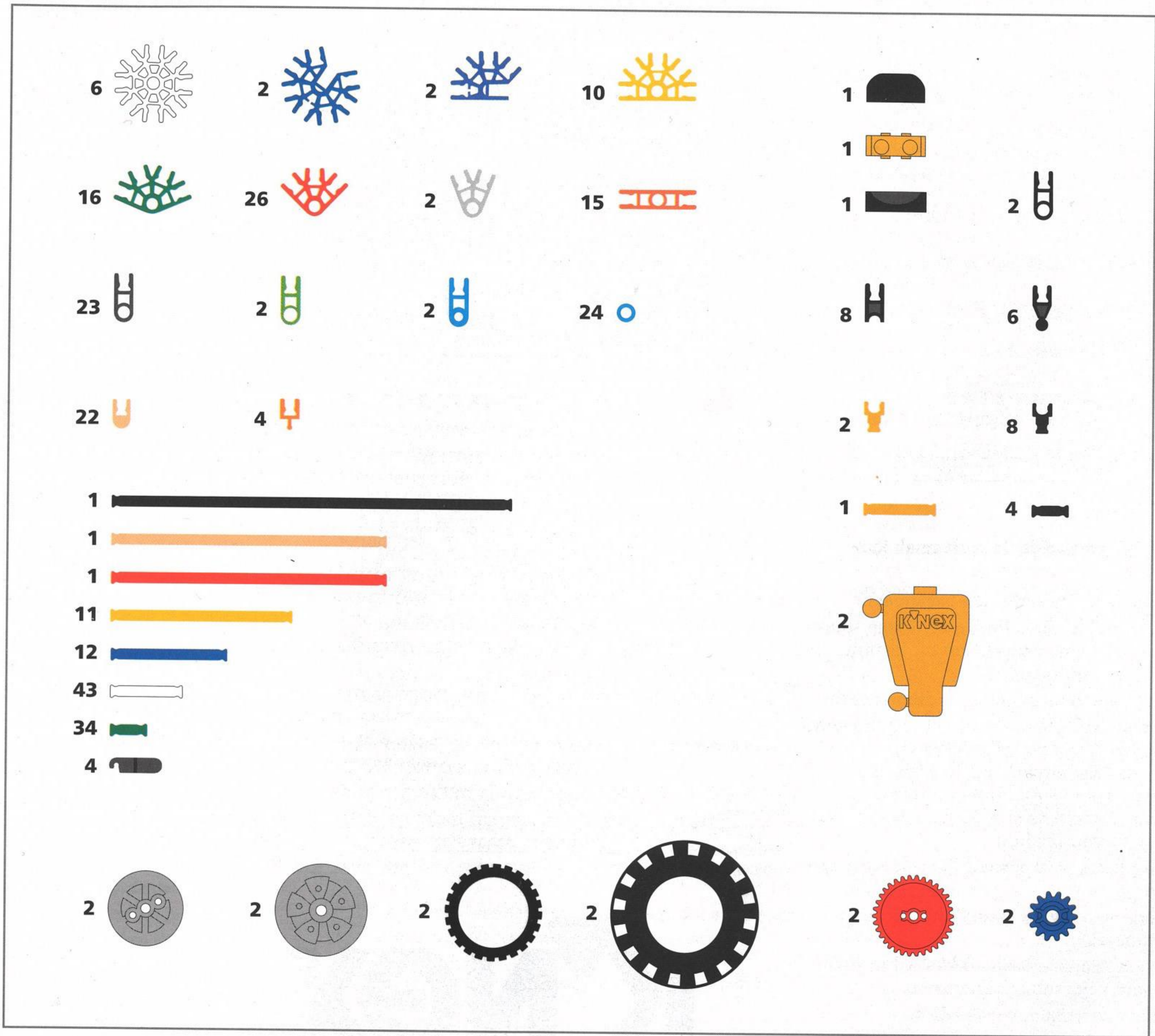

GB K'NEX is a registered trademark of K'NEX Industries, Inc. K'NEX International, Century House, Station Way, Cheam, Surrey, SM3 8SW, United Kingdom. FREEPHONE 0800 834938 (UK only) Printed in the USA on recycled paper.

F K'NEX est une marque déposée de K'NEX Industries, Inc. K'NEX France, ZA de la Plaise, 73370 Le Bourget-du-Lac. Hasbro (Schweiz) AG, Alte Bremgartenstrasse 2, CH-8965 Berikon and S.A. Hasbro N.V., Riverside Business Park - Spey House, Bld Internationale 55/4 Internationale Laan, Bruxelles 1070 Brussel. Imprimé aux États-Unis sur papier recyclé.

I K'NEX è un marchio di fabbrica registrato della K'NEX Industries, Inc. Stampato negli USA su carta riciclata.

D K'NEX ist ein eingetragenes Warenzeichen der K'NEX Industries, Inc. K'NEX GmbH, Waldstraße 49, 90763 Fürth. Hasbro (Schweiz) AG, Alte Bremgartenstrasse 2, CH-8965 Berikon. Gedruckt in den USA auf Recyclingpapier.

E K'NEX es una marca registrada de K'NEX Industries, Inc. Distribuido en España por M.B. España S.A. Apartado de Correos 133 Quart de Poblet-Valencia. N.I.F. A-46156444; R.I. 6170. Los colores de los componentes pueden diferir de los indicados en la caja. Recomendamos que guarde nuestra dirección por si le es necesaria más adelante. Impreso en Estados Unidos en papel reciclado.

S K'NEX är ett registrerat varumärke av K'NEX Industries, Inc. Hasbro Sweden AB, Johanneslundsvägen 2, Business Campus, S-194 81 Upplands Väsby. Tryckt i USA på återvunnet papper.

DK K'NEX er et registreret varemærke, der tilhører K'NEX Industries, Inc. Hasbro Denmark A/S, Ejby Industrivej 40, DK-2600 Glostrup. Trykt i USA på genbrugspapir.

N K'NEX er et registrert varemerke som tilhører K'NEX Industries, Inc. Hasbro Norway AS, Nye Vakås Vei 64, N-1360 Nesbru. Trykt i USA på gjenvunnet papir.

SF K'NEX on K'NEX Industries, Inc. rekisteröimä tavaramerkki. Hasbro Finland OY, Vattuniemenranta 2, SF-00210 Helsinki. Painettu USA:ssa uusiopaperille.

NL K'NEX is een handelsmerk van de K'NEX Industries, Inc. Hasbro B.V., Smart Business Park, Kanaalweg 16 G, 3526 KL Utrecht. S.A. Hasbro N.V., Riverside Business Park - Spey House, Bld Internationale 55/4 Internationale Laan, Bruxelles 1070 Brussel. In Amerika op kringlooppapier gedrukt.

P K'NEX é uma marca registada da K'NEX Industries, Inc. Distribuido em Portugal por HASBRO, IMPORTAÇÃO e EXPORTAÇÃO DE JOGOS E BRINQUEDOS LDA, Rua Melo e Sousa, Bloco 2, Estoril Garden, 2765 Estoril. NIF 502949546. As cores dos componentes podem diferir das indicadas na caixa. Recomendamos que anotem a nossa morada para futura referência. Impreso nos Estados Unidos em papel reciclado.

G Το K'NEX είναι σήμα κατατεθέν της K'NEX Industries, Inc. Τυπώθηκε στις Ηνωμένες Πολιτείες σε ανακυκλωμένο χαρτί.

TR K'NEX, K'NEX Industries, Inc.'in tescilli markasıdır. INTERTOY tarafından ithal edilmiştir. PK 221, Şişli İstanbul. A.B.D.'de yeniden kullanılmış kağıda basılmıştır.

J K'NEXは K'NEX Industries, Inc. の登録商標です。リサイクル紙使用 Printed in the USA.

CHI K'NEX 是 K'NEX Industries, Inc. 的注册商標。香港九龍尖沙嘴廣東道七號海港城世運中心一五零六室 Palmyra (香港) 有限公司台灣分公司, 台北縣砂址鎮中興路九十五號五樓二室 在美國用再生紙印刷。

IL K'NEX Industries, Inc. הוא סימן מסחרי רשום של הסברו ישראל בע"מ, שדרות הרצל 104, ירושלים 96187 מודפס בארצות הברית על נייר ממוחזר

©1997 K'NEX Industries, Inc. • Hatfield, PA 19440-0700 • 1-800-KID-KNEX (USA & CANADA)

K'NEX is a registered trademark of K'NEX Industries, Inc. Manufactured under U.S. Patents 5,061,219, 5,137,486, 5,199,919, 5,238,438, 5,346,420, 5,350,331, 5,368,514, 5,421,762, 5,423,707, 5,427,559 and 5,518,435. Other U.S. and foreign patents pending.

Conforms to the Requirements of ASTM Standard Consumer Safety Specification on Toy Safety F963-95.