

K'nex

ULTIMATE 100 MODEL
Building Set
MODÈLE 100 ULTIME
Jeu de Construction

IMAGINE™

100 BUILDS
MODÈLES*

Ages / Âge
7-12

15503



(EN) **CONTENTS**

Bus 4
 Tic-Tac-Toe 4
 Fishing Rod 5
 Skateboarder 6
 Motorcycle 8
 Dinghy 10
 Brachiosaurus 13
 Excavator 16
 Space Shuttle 19
 Eiffel Tower 22
 Flying Saucer 26
 Pod Spinner 31
 Ambulance 36
 Large Helicopter 42
 Blimp 52
 Building Ideas 60

(FR) **CONTENU**

Bus 4
 Tic-Tac-Toe 4
 Canne à pêche 5
 Planchiste 6
 Motocyclette 8
 Barque 10
 Brachiosaure 13
 Excavateur 16
 Navette spatiale 19
 La tour Eiffel 22
 Soucoupe volante 26
 Radar tournant 31
 Ambulance 36
 Grand hélicoptère 42
 Dirigeable 52
 Idées de construction 60

Parts List

Before you start building, be sure to compare the parts in your set with the parts listed here. If anything is missing, call or write to us using the information on the back cover. We are here to help you!

Liste des pièces

Avant de commencer à construire, assure-toi de comparer les pièces dans ta boîte à la liste de pièces fournie ici. S'il manque quelque chose, téléphone-nous ou écris-nous en te servant des informations figurant au verso de la notice. Nous sommes là pour t'aider!

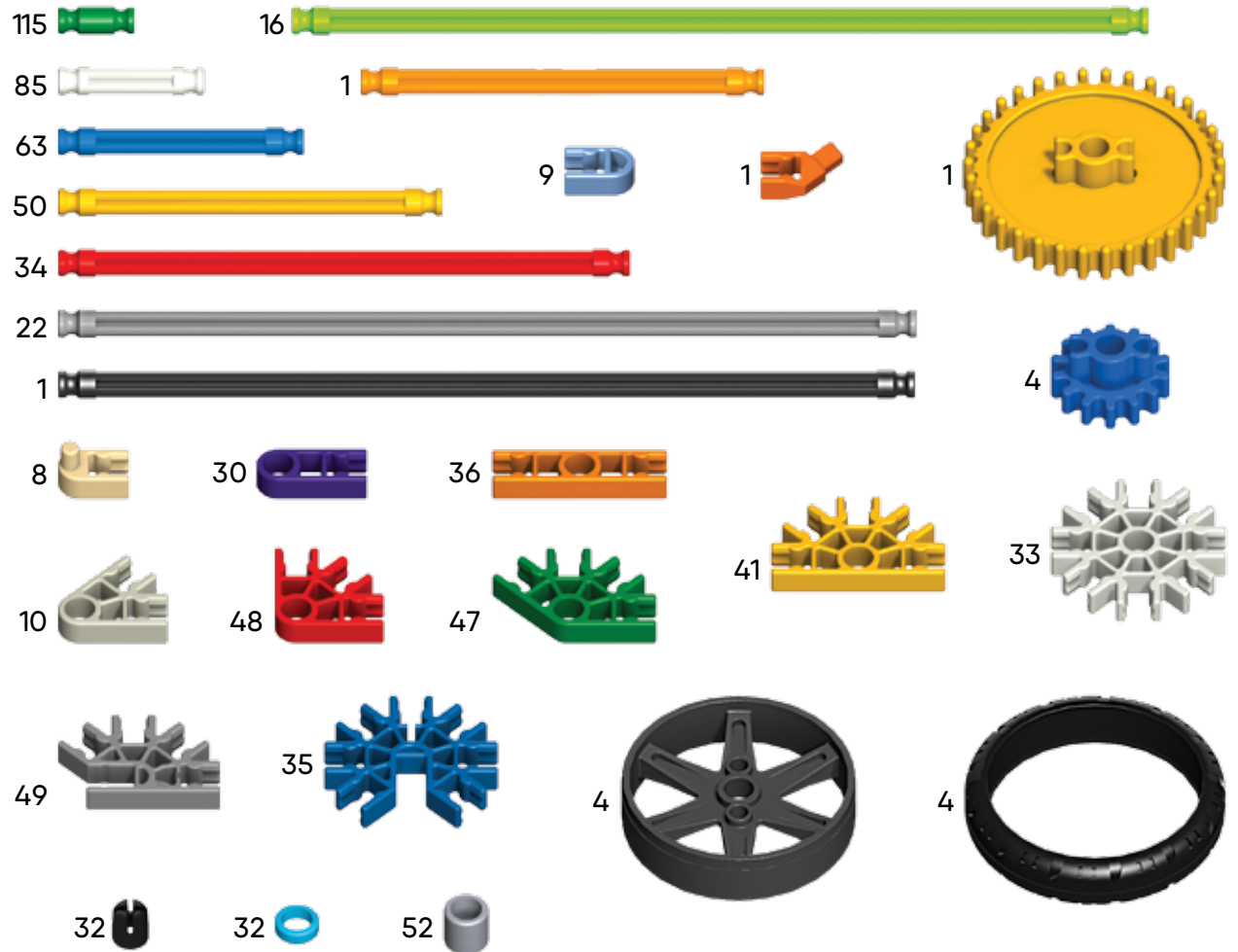

Building Basics

Bases de la construction



Start Building

To begin your model, find the **1** and follow the numbers. Each piece has its own shape and colour. Just look at the pictures, find the pieces in your set that match and then connect them together. Try to face your model in the same direction as the instructions while you build. The arrows show you where the parts connect, but not all connection points have arrows. Faded colours show you this section is already built.

Démarre ta construction

Pour commencer ton modèle, trouve l'étape numéro **1** et suis les numéros. Chaque pièce a sa propre forme et sa propre couleur. Regarde les illustrations, trouve les pièces qui correspondent à ce que tu vois et assemble-les. Pour t'aider pendant que tu construis, oriente ton modèle dans le même sens que les instructions. Les flèches t'indiquent où les pièces s'assemblent, mais les points de raccordement n'ont pas tous des flèches. Les pièces de couleur délavée sont celles que tu as déjà assemblées.

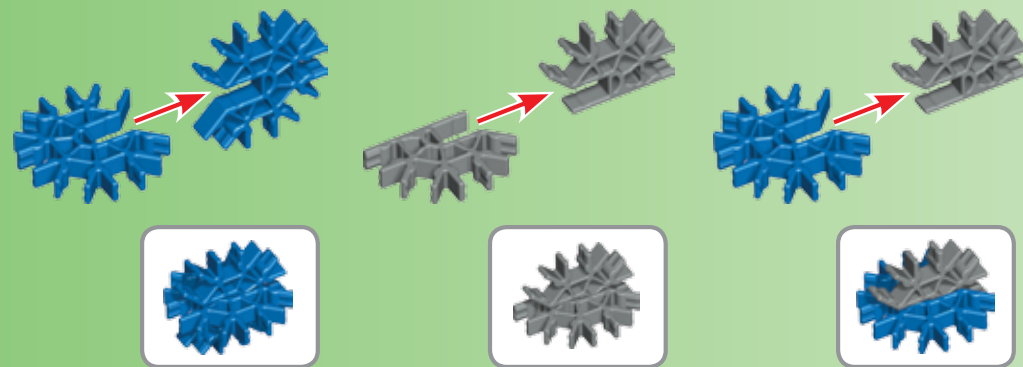

Connectors

You can slide these special connectors together. Push tightly until you hear a "click." Pay close attention to the instructions and position them horizontally or vertically exactly as they are shown.

Connecteurs

Vous pouvez assembler ces connecteurs tout à fait uniques en les faisant glisser l'un dans l'autre. Pousser fort jusqu'au « clic ». Lire les instructions attentivement et les positionner horizontalement ou verticalement, en suivant exactement les illustrations.

Spacers

There are places in your model where you need to use spacers. Be sure to use the correct colour and number of spacers shown in the instructions.



Séparateurs

Il y a des endroits sur le modèle où des séparateurs sont nécessaires. S'assurer d'utiliser la bonne couleur et le nombre d'espaceurs indiqué sur les instructions.

Flexible Rods

You can bend a flexible rod to make curved shapes. It will be easier to attach to your model if you bend it back and forth a few times first.

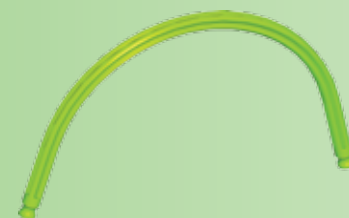

Tiges flexibles

Une tige flexible est une tige que tu peux courber pour faire des courbes. Elle pourra être attachée plus aisément à ton modèle si tu la plies en avant et en arrière plusieurs fois.

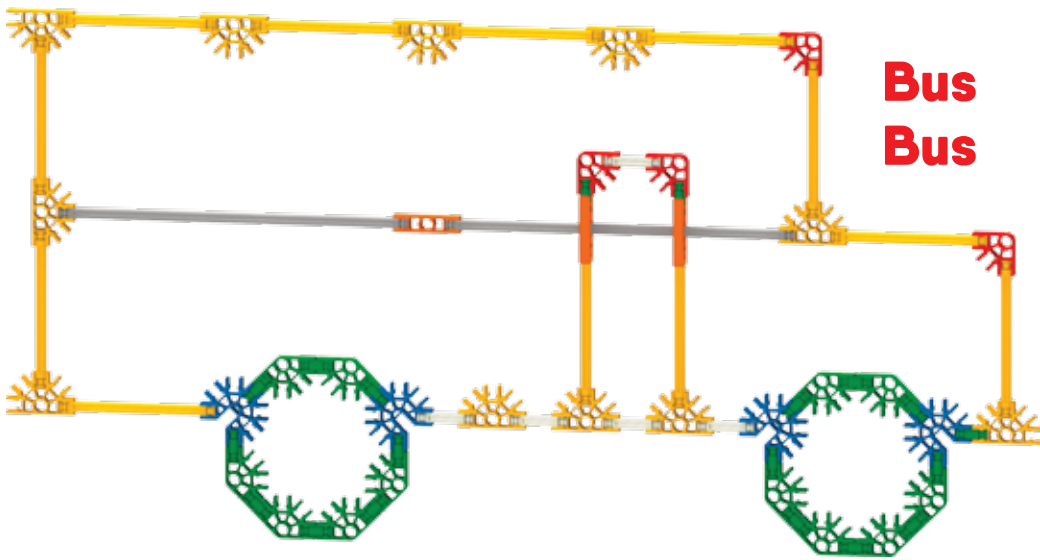

Bus
Bus



(EN) **WARNING: CHOKING HAZARD** - Small parts. Not for children under 3 years.

(FR) **ATTENTION** : RISQUE D'ÉTOUFFEMENT - Pièces de petite taille. Ne convient pas aux enfants de moins de 3 ans.

Tic-Tac-Toe Tic-Tac-Toe

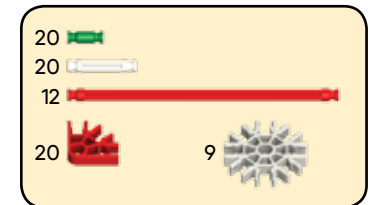
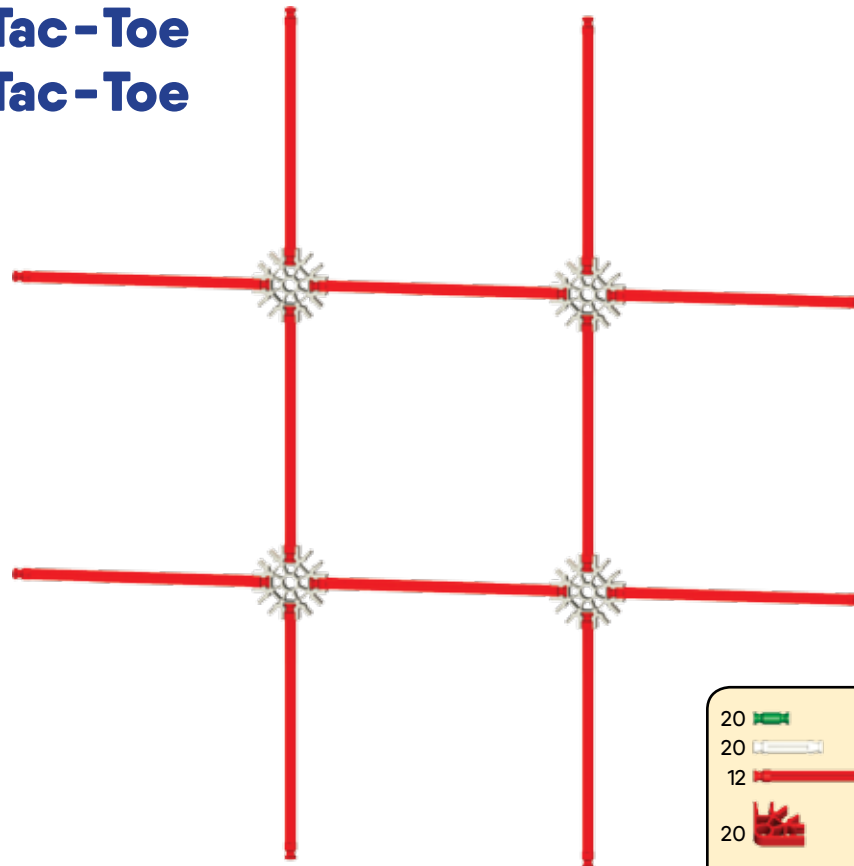

Fishing Rod Canne à pêche



1

2

1 - 2

14	2	1	3
6			
1		1	
1	2	1	1

1 - 2









3

2	5	1
2		

1 - 3

Skateboarder Planchiste





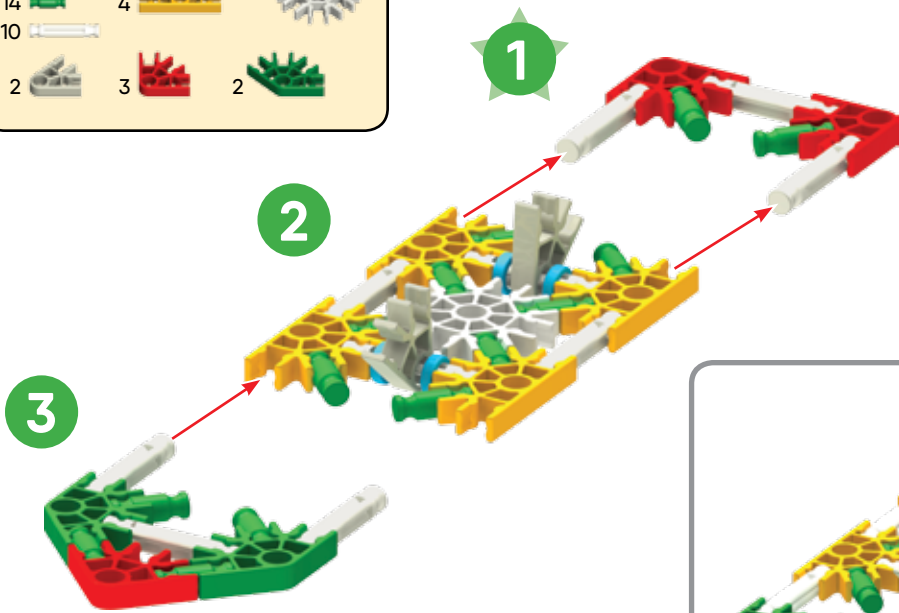

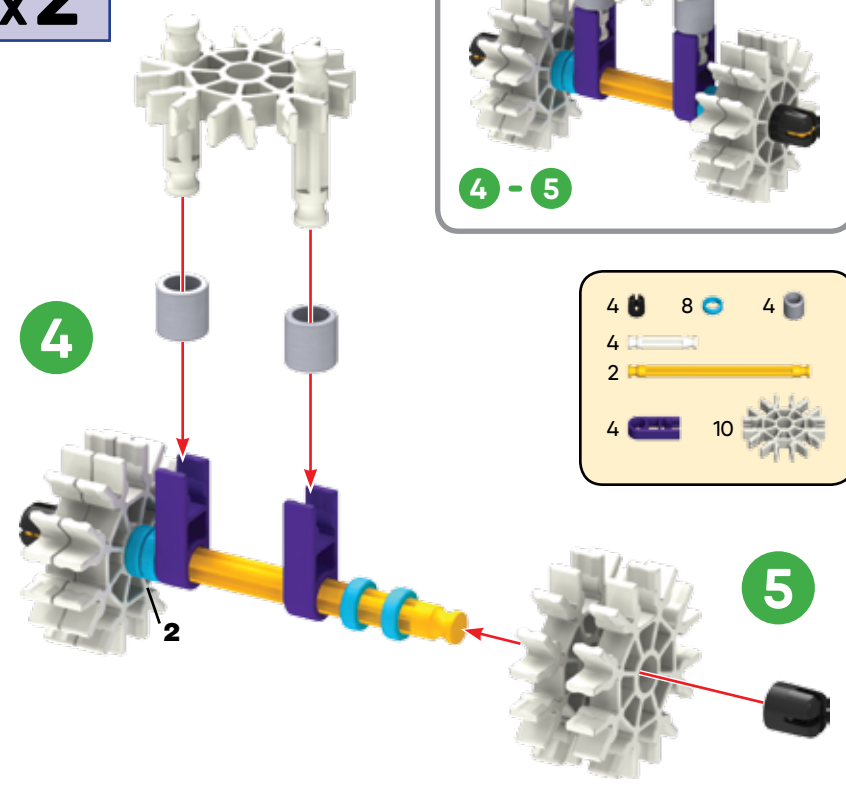

- 4 
- 14 
- 10 
- 2 
- 4 
- 3 
- 1 
- 2 



x2



- 4 
- 4 
- 2 
- 4 
- 8 
- 4 
- 10 

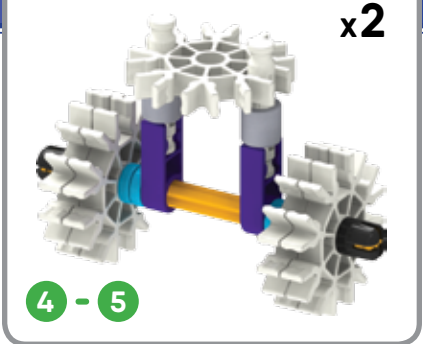

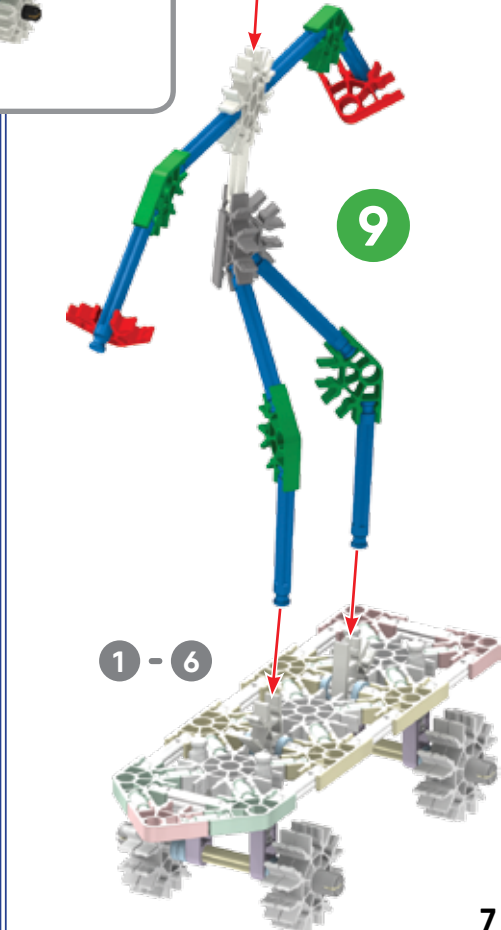
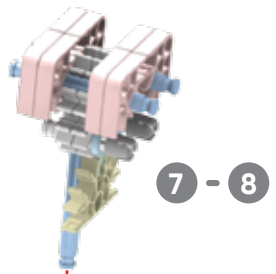
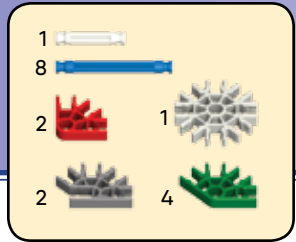
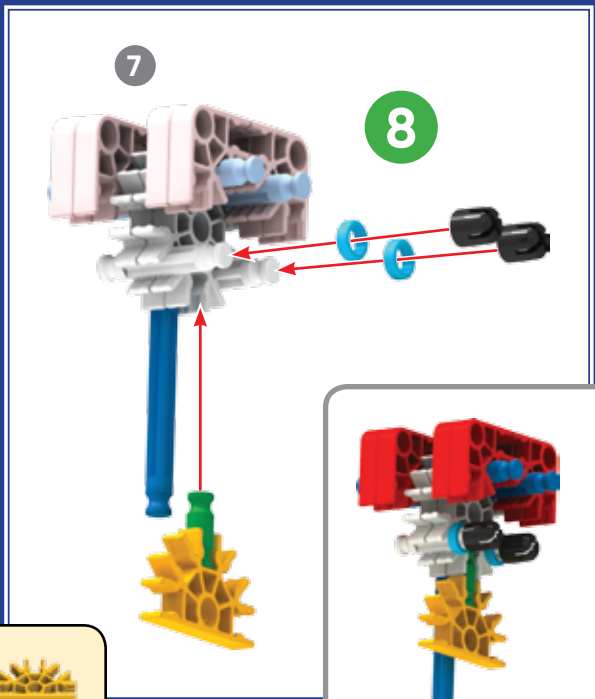
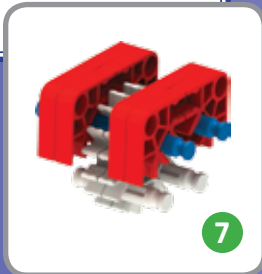
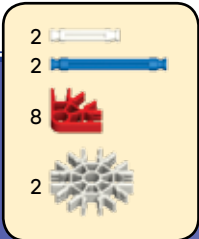
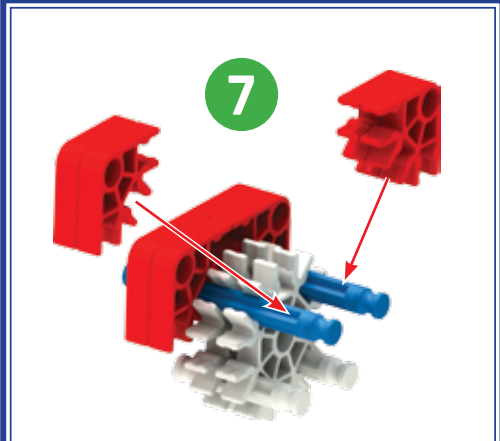
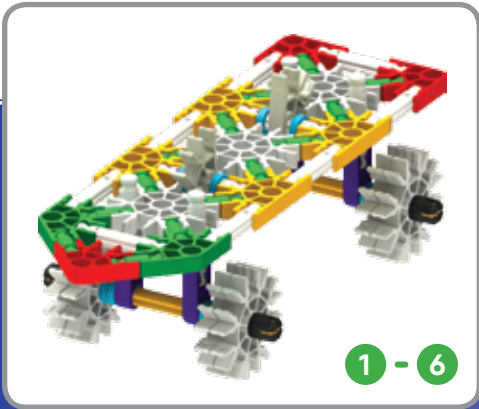
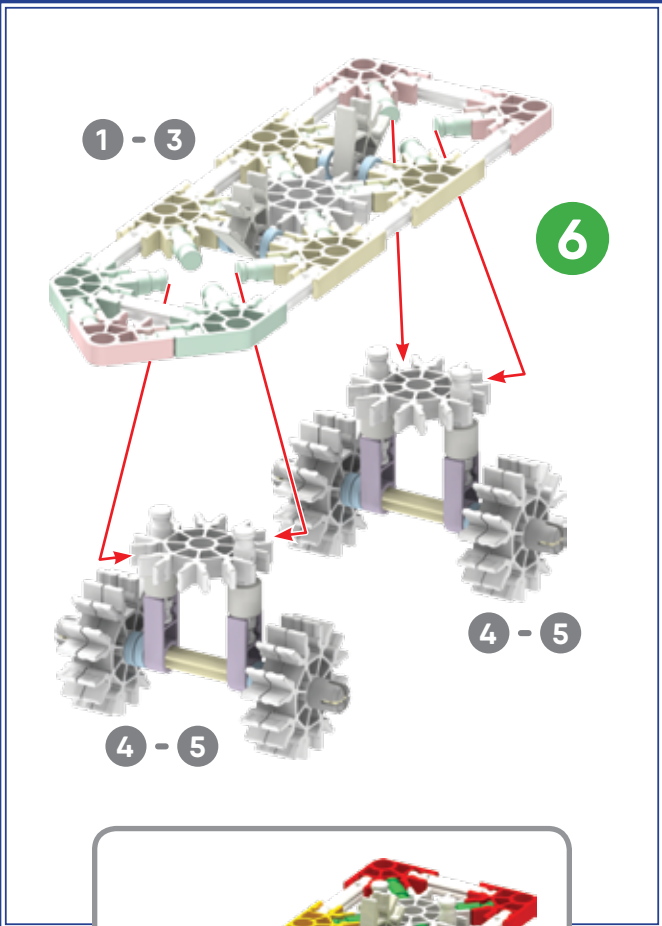

Motorcycle Motocyclette

1

6	1	1	1
1	1	1	1
1	1	1	1
1	1	1	1
1	1	1	1

1

10	2	2	2
2	2	2	2
2	2	2	2
4	2	4	4

2 **x2**

2

3

4

20	2	4	6	4
10	1	1	1	1
2	4	2	2	4

3 - 4

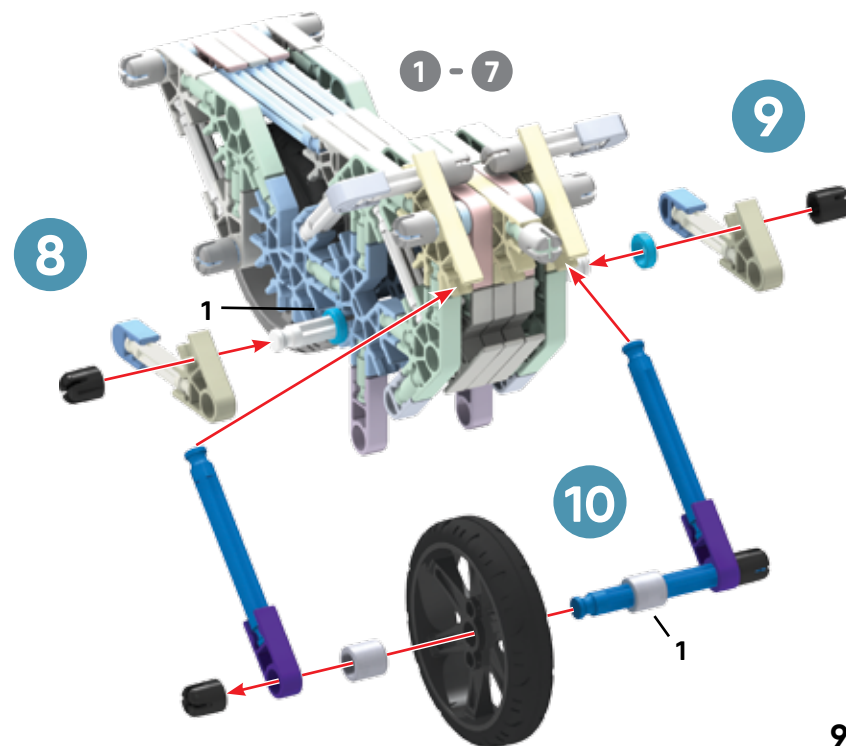
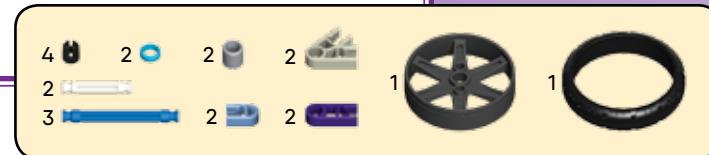
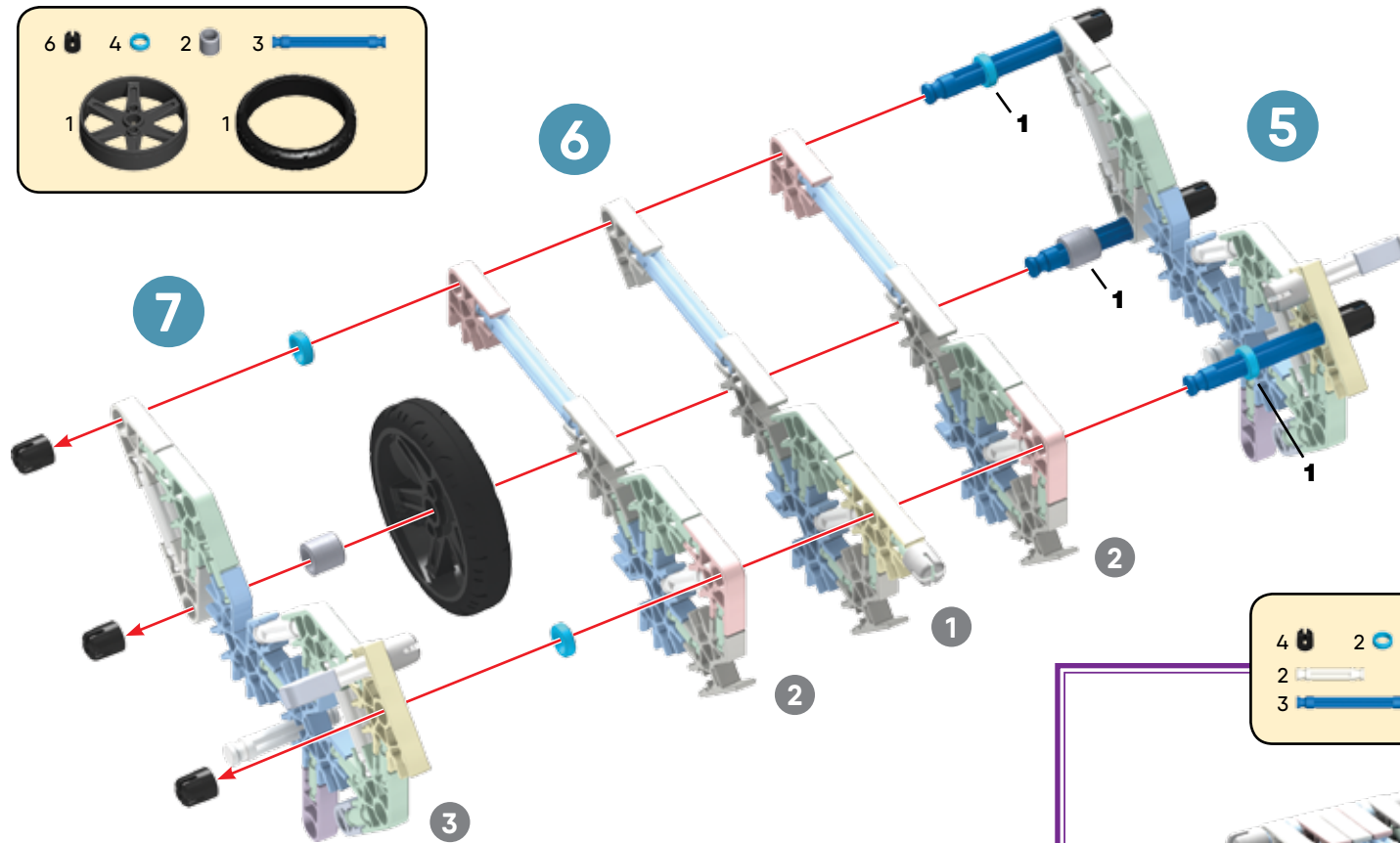
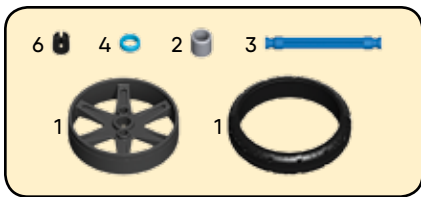



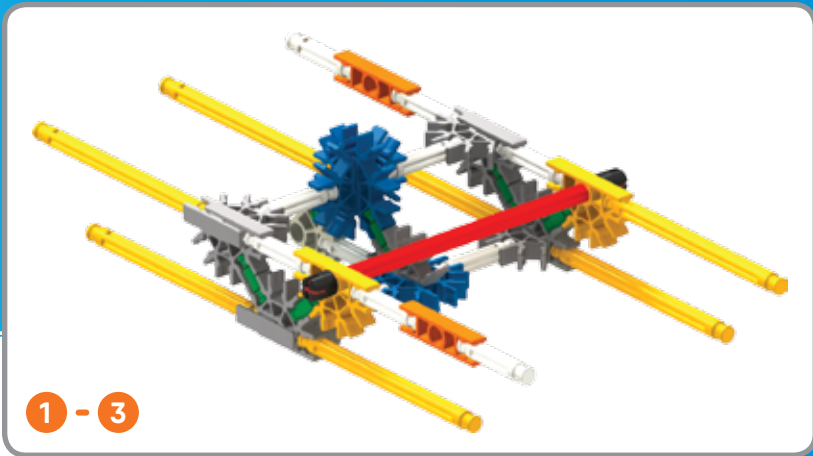



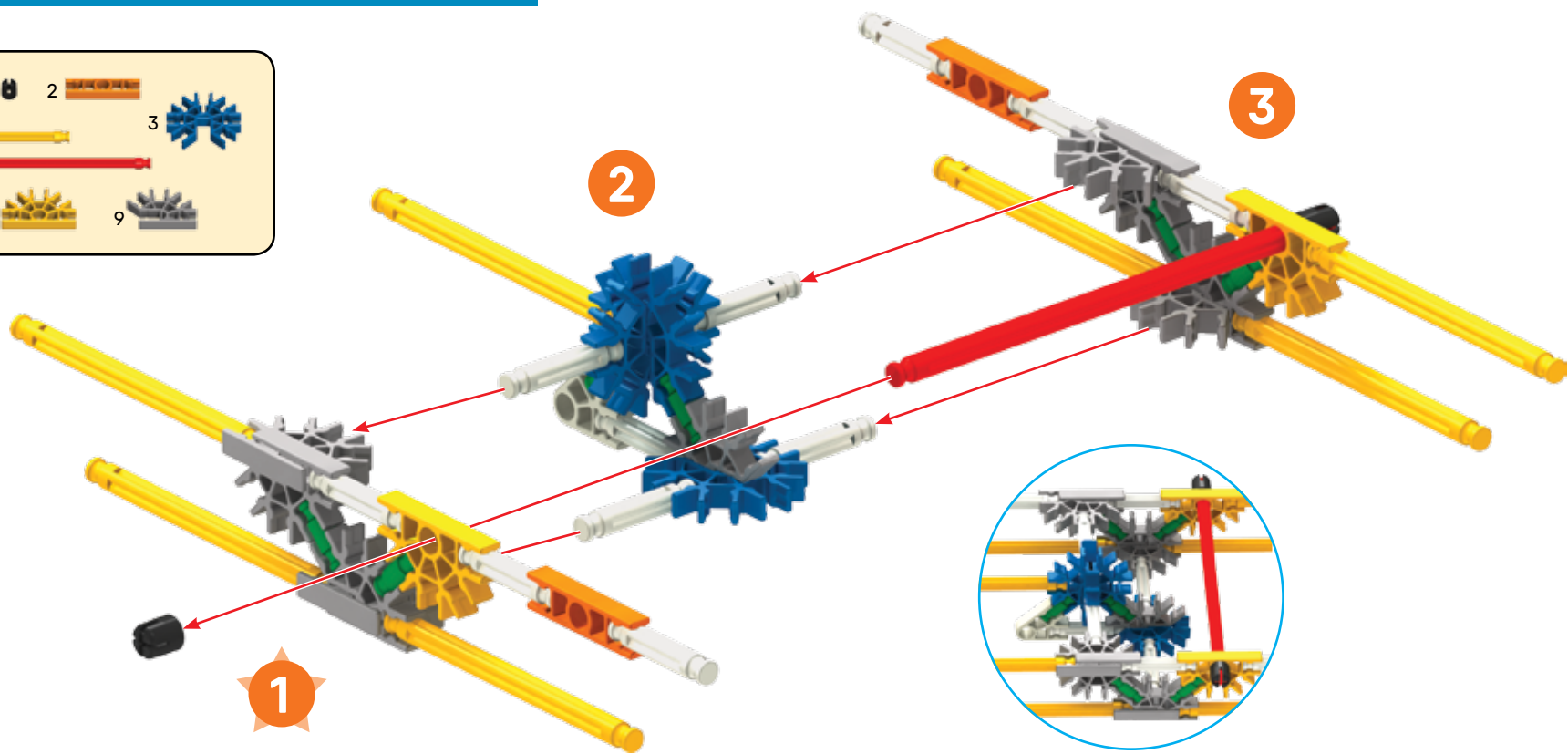

Dinghy Barque







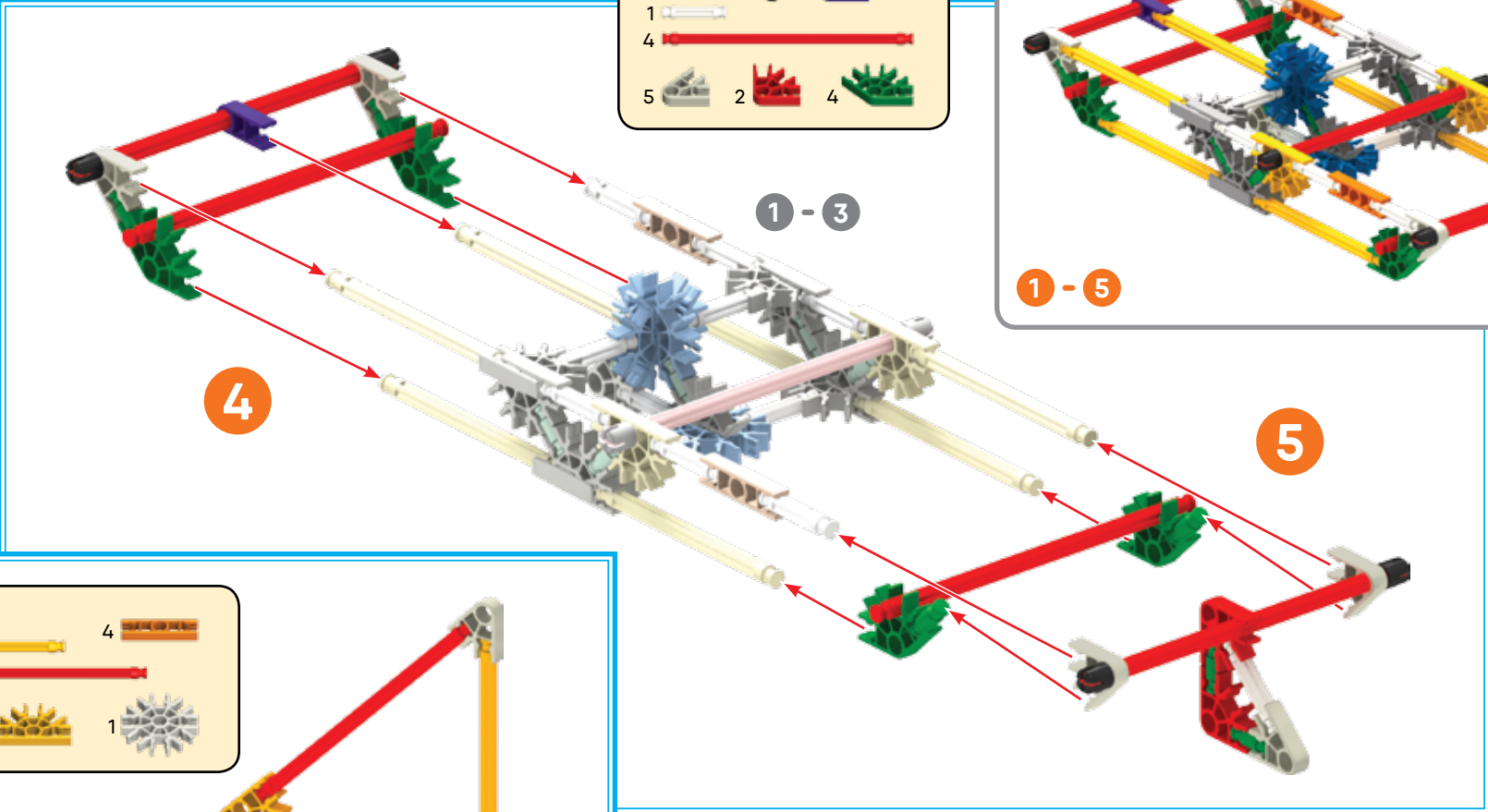

- 6 2 2 3
- 11 7 1
- 1 2 9



- 6  4  1 
- 1  4 
- 4 
- 5  2  4 



- 9  4 
- 6  2 
- 2  4  1 

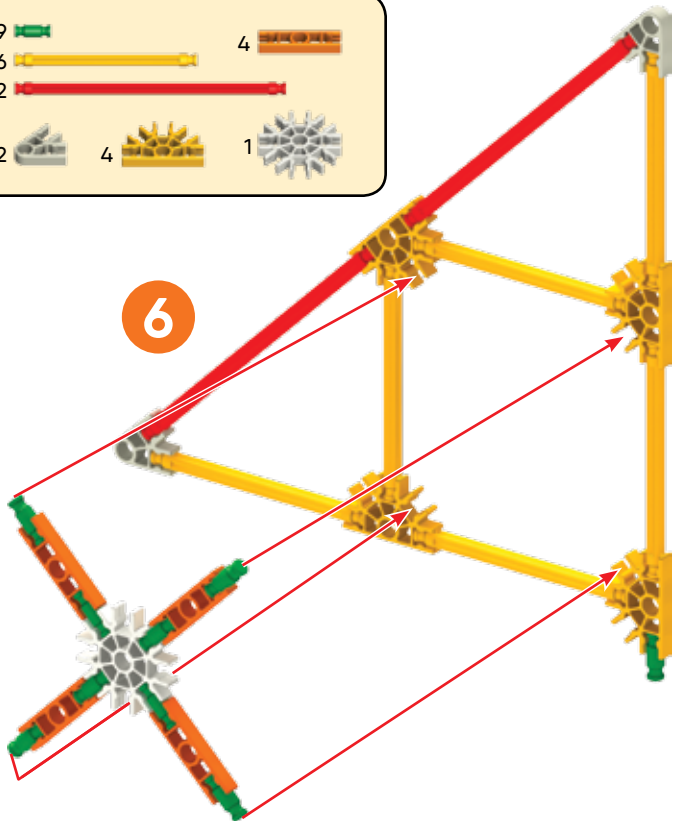

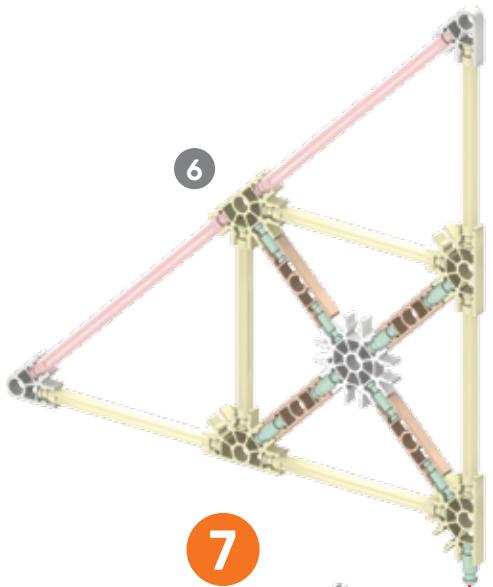

7

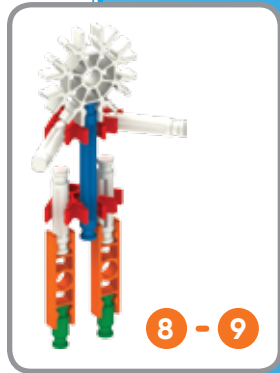
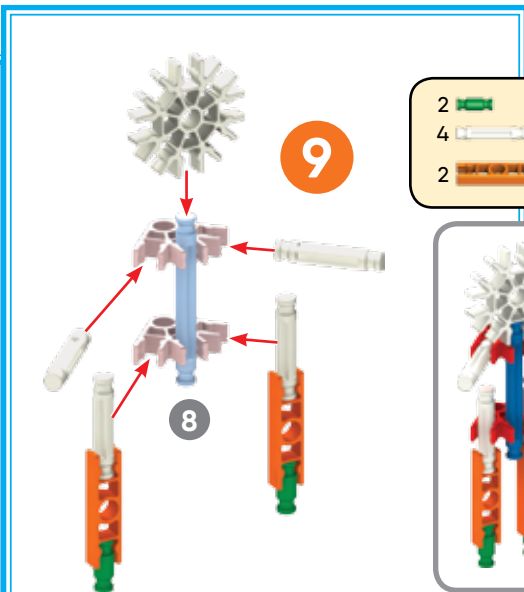
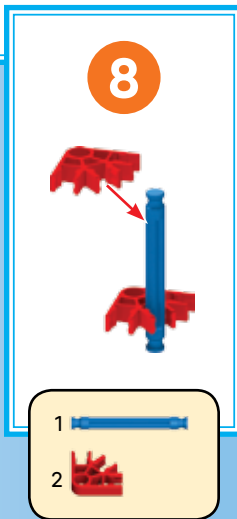
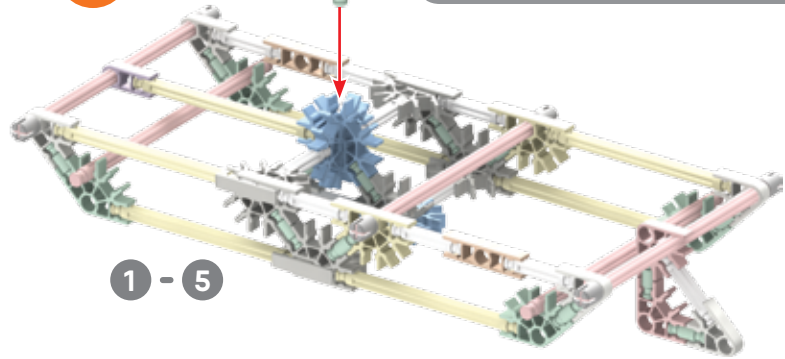

8 - 9

10

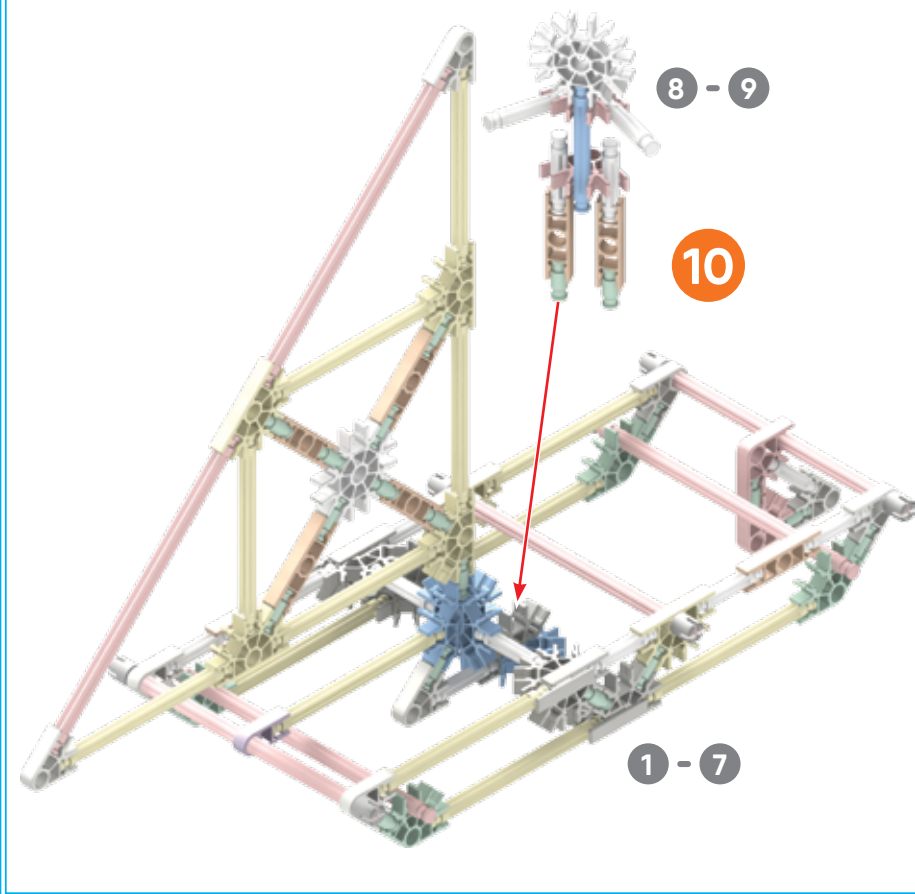

Brachiosaurus Brachiosaure



2

14		8		4	
10					
8					

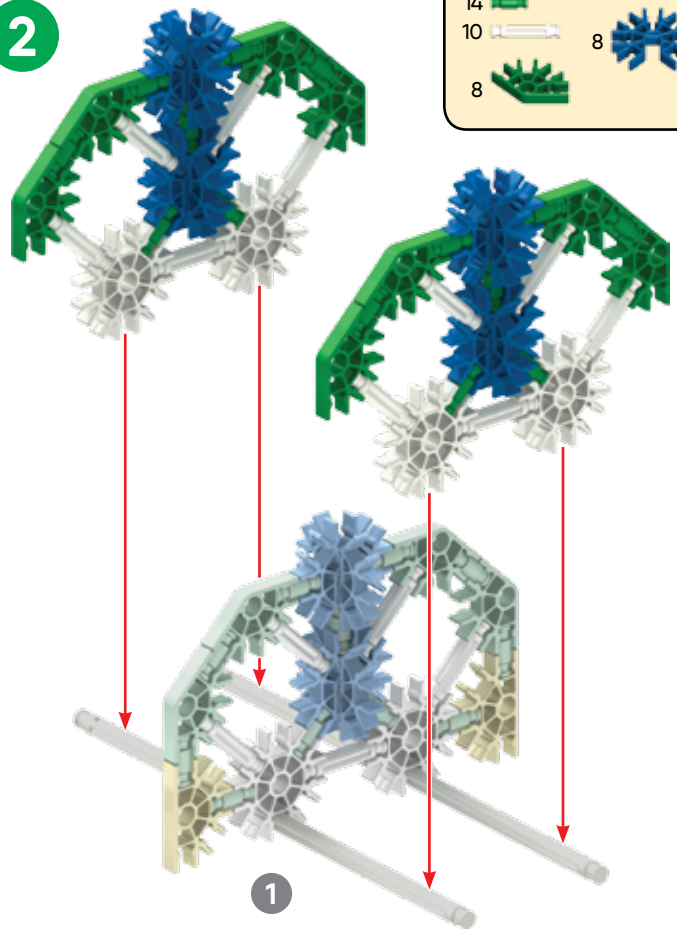

1



1

11		4	
5			
2			
2		2	
		4	

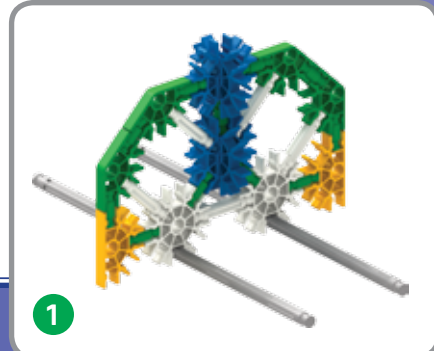

1

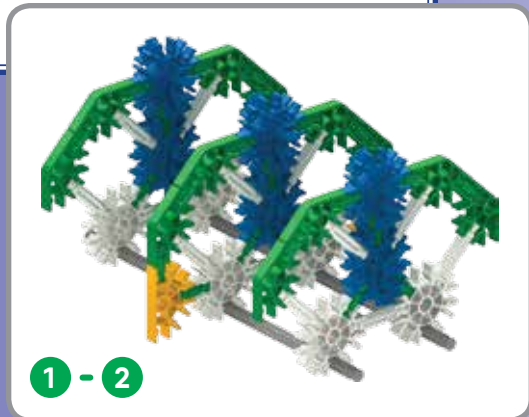

1 - 2

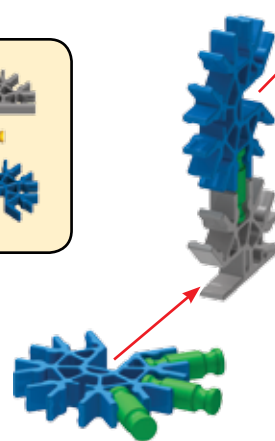
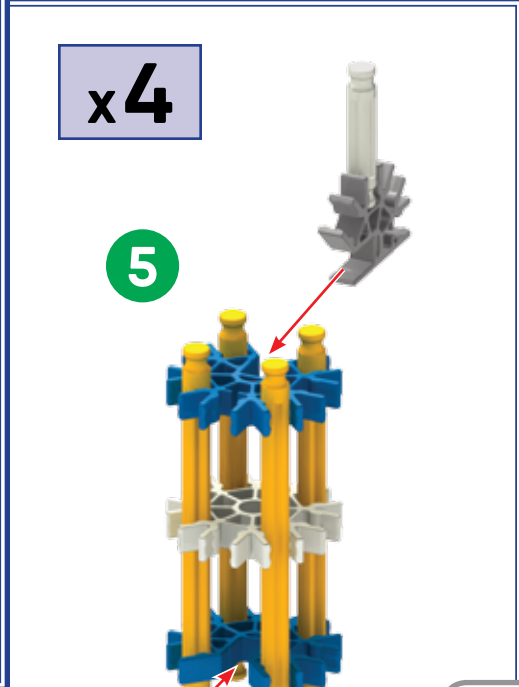
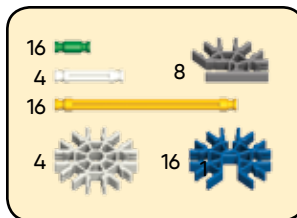
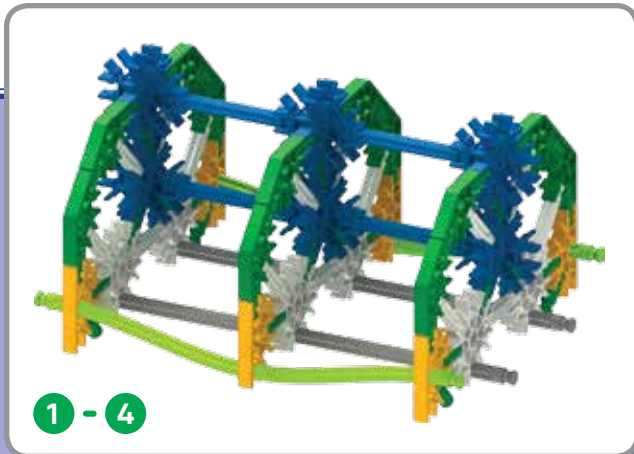
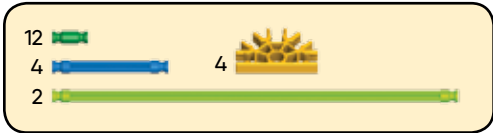
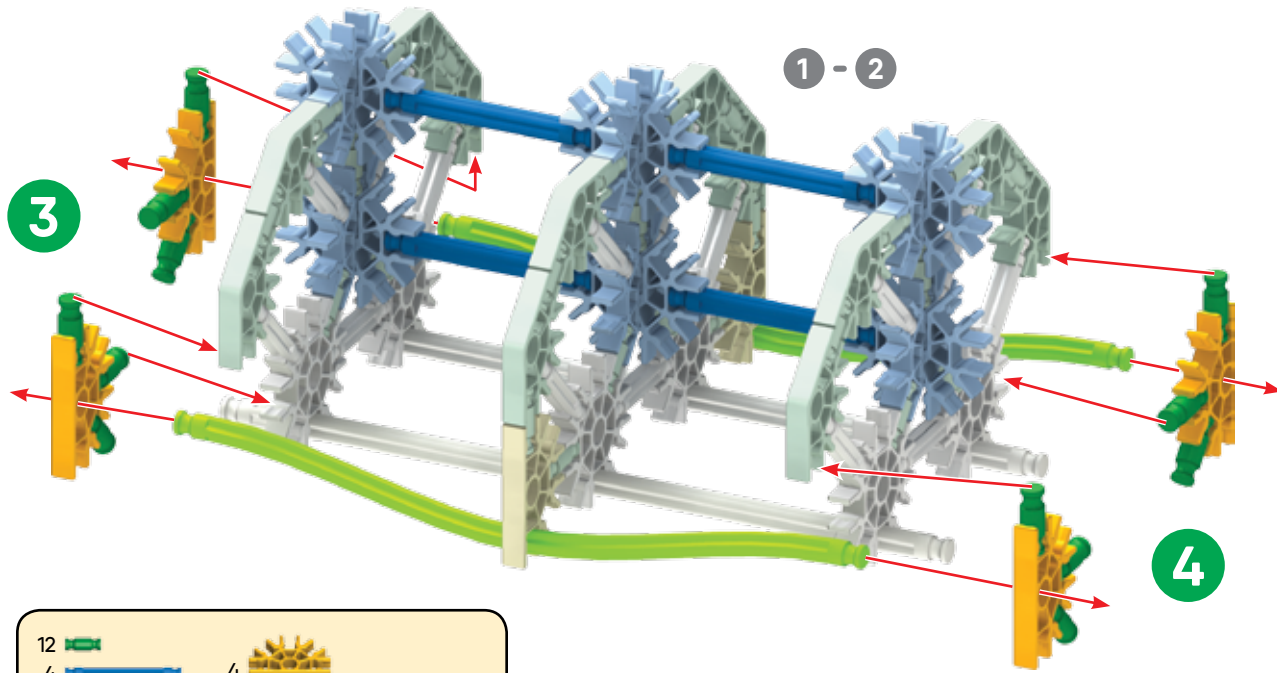

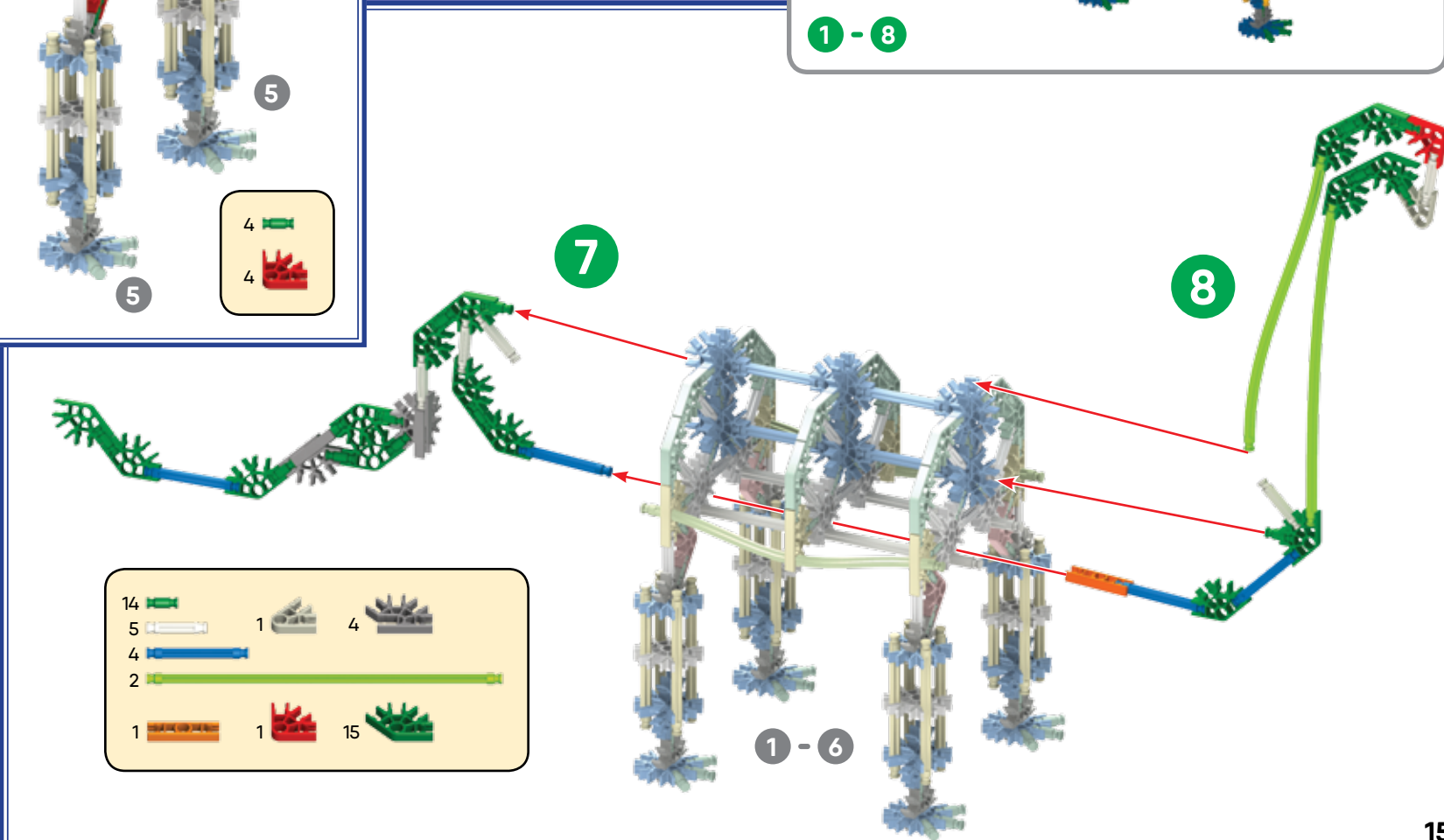
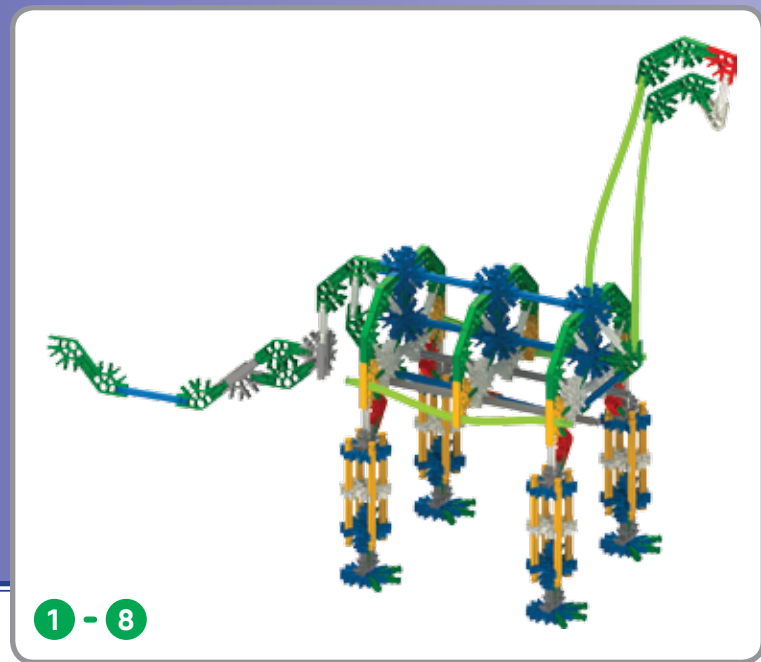
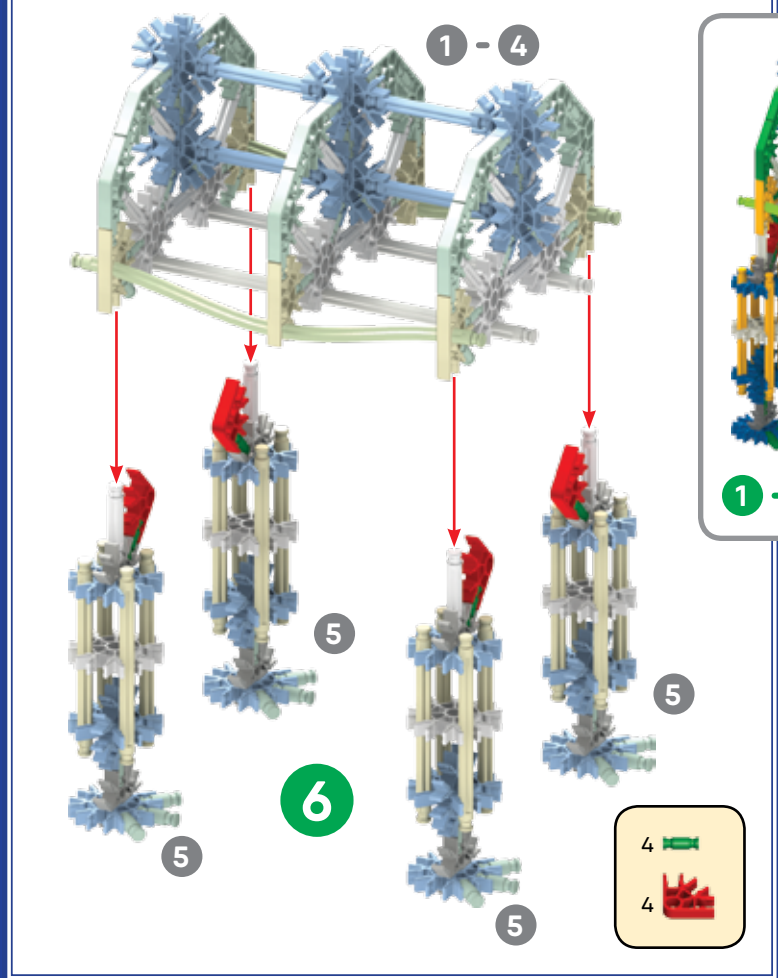

Excavator Excavateur

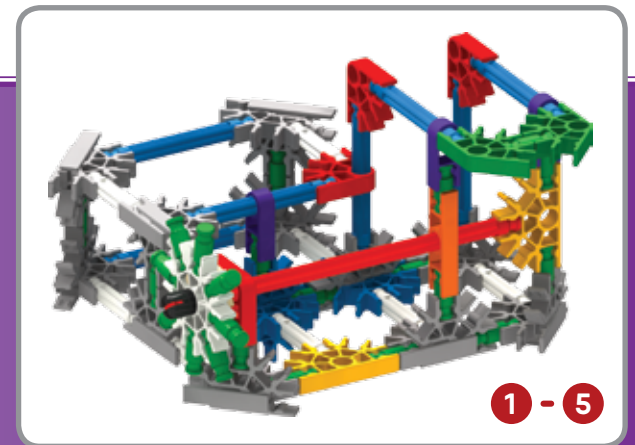
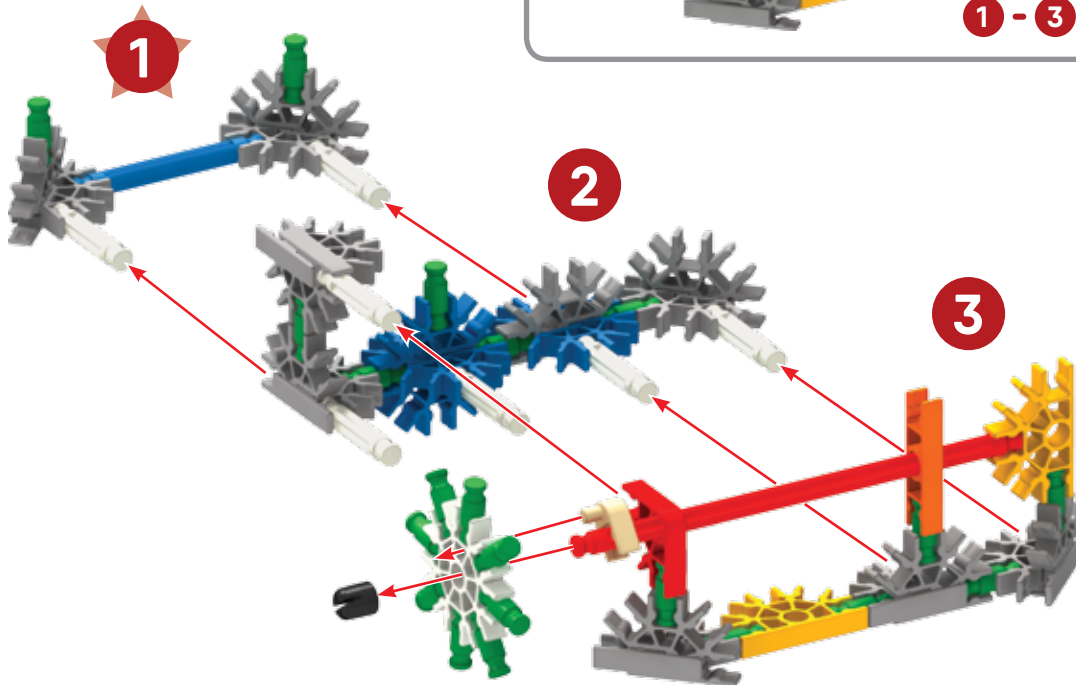
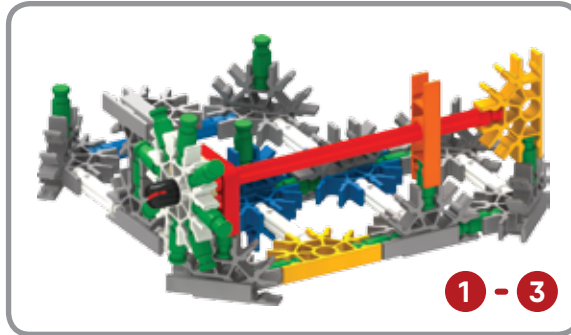
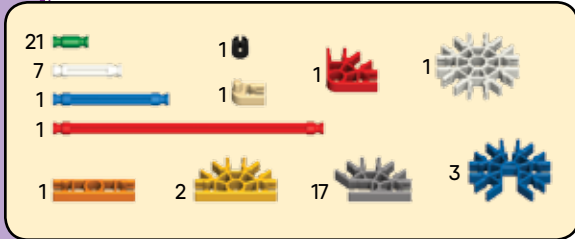
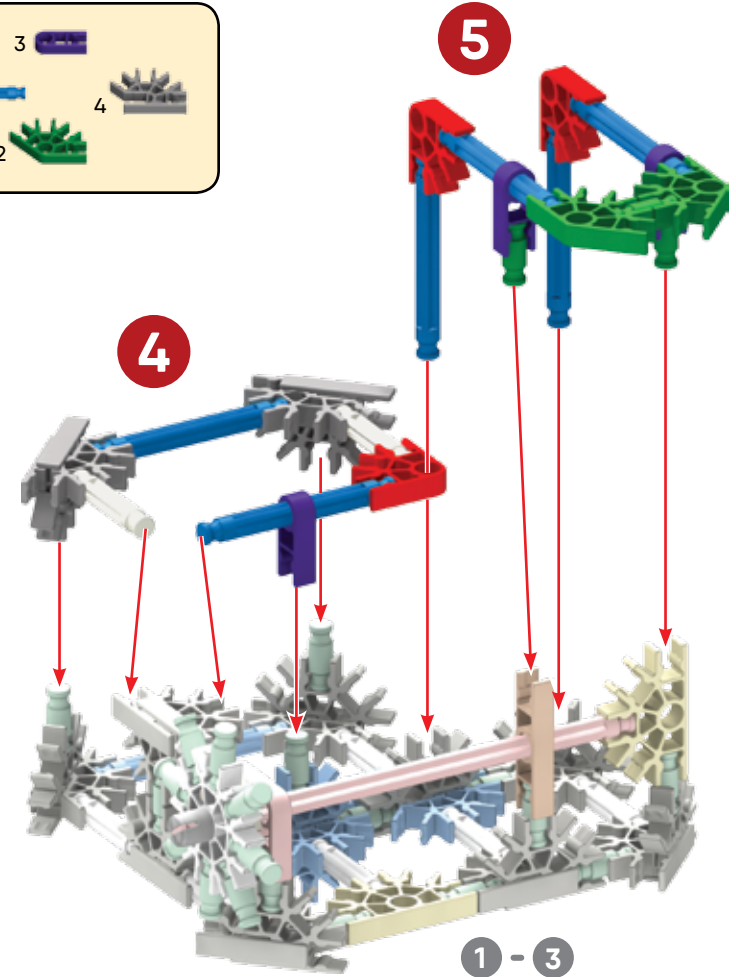
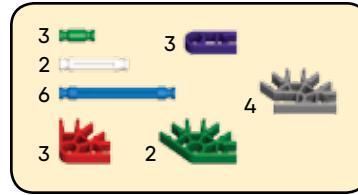

6

6

1 5 1

2 2

x6

7

7

6 12 12

24 6

12

7

7

7

7

7

8

6

6 - 8

1 - 9

9

1 - 5

6 - 8

11

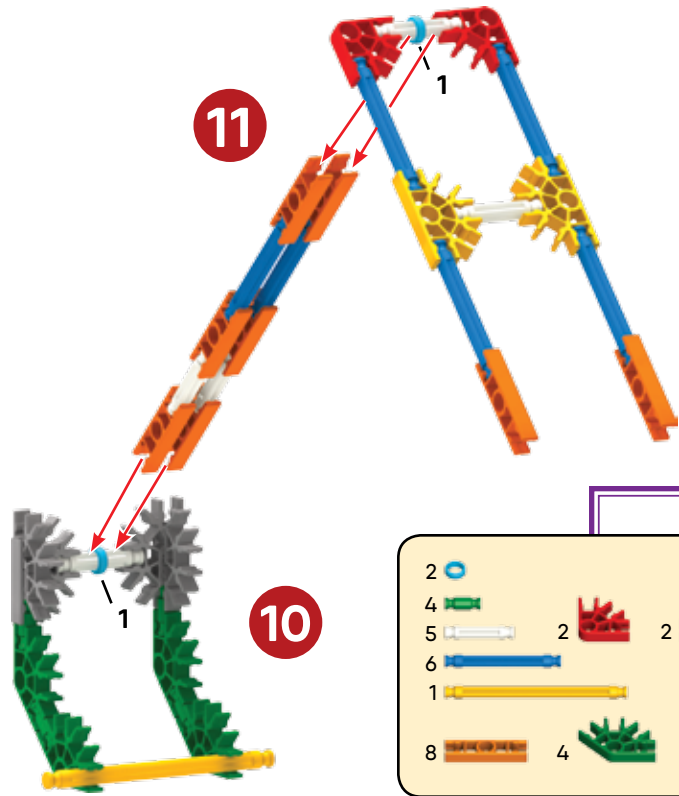

10

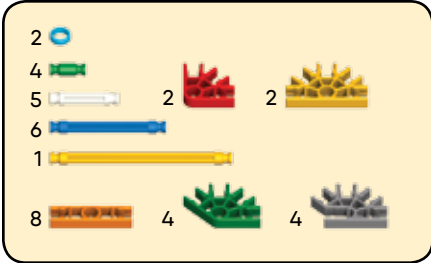

1 - 12



10 - 11

12

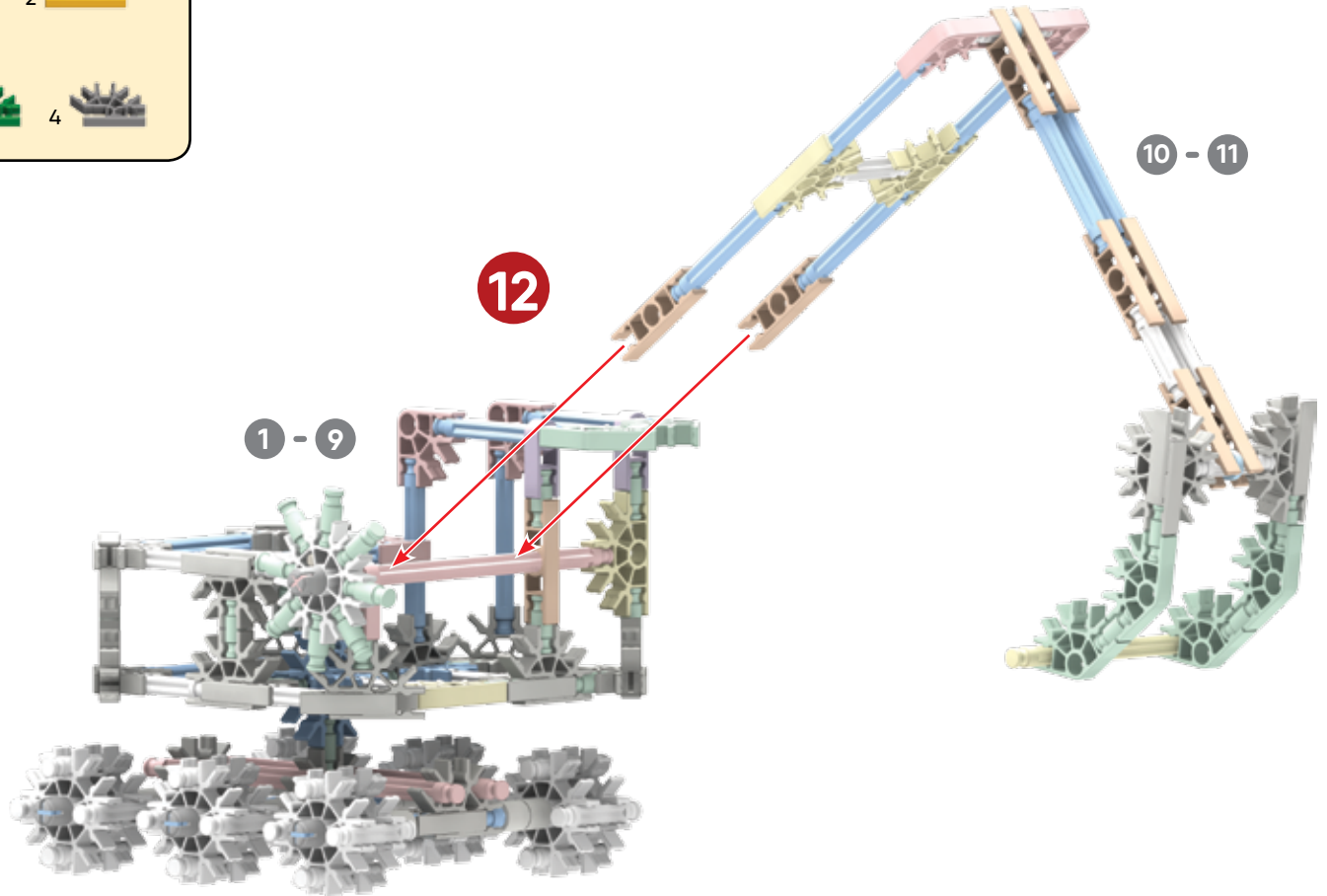

1 - 9

10 - 11

Space Shuttle

Navette spatiale

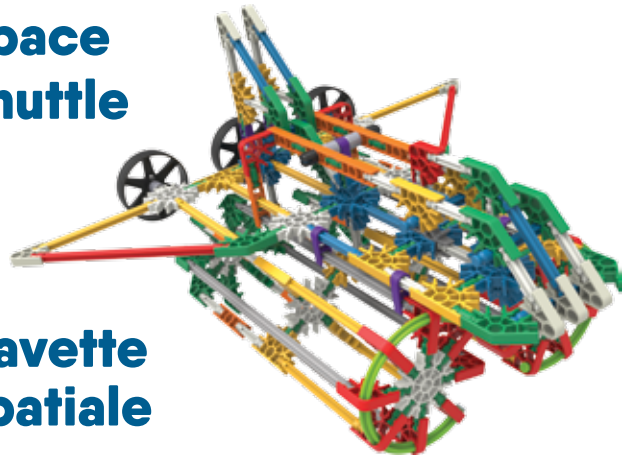

- | | | | |
|---|--|---|--|
| 2 | | 3 | |
| 5 | | | |
| 8 | | | |
| 5 | | | |
| 1 | | 2 | |
| 6 | | | |
| 2 | | | |
| 6 | | | |

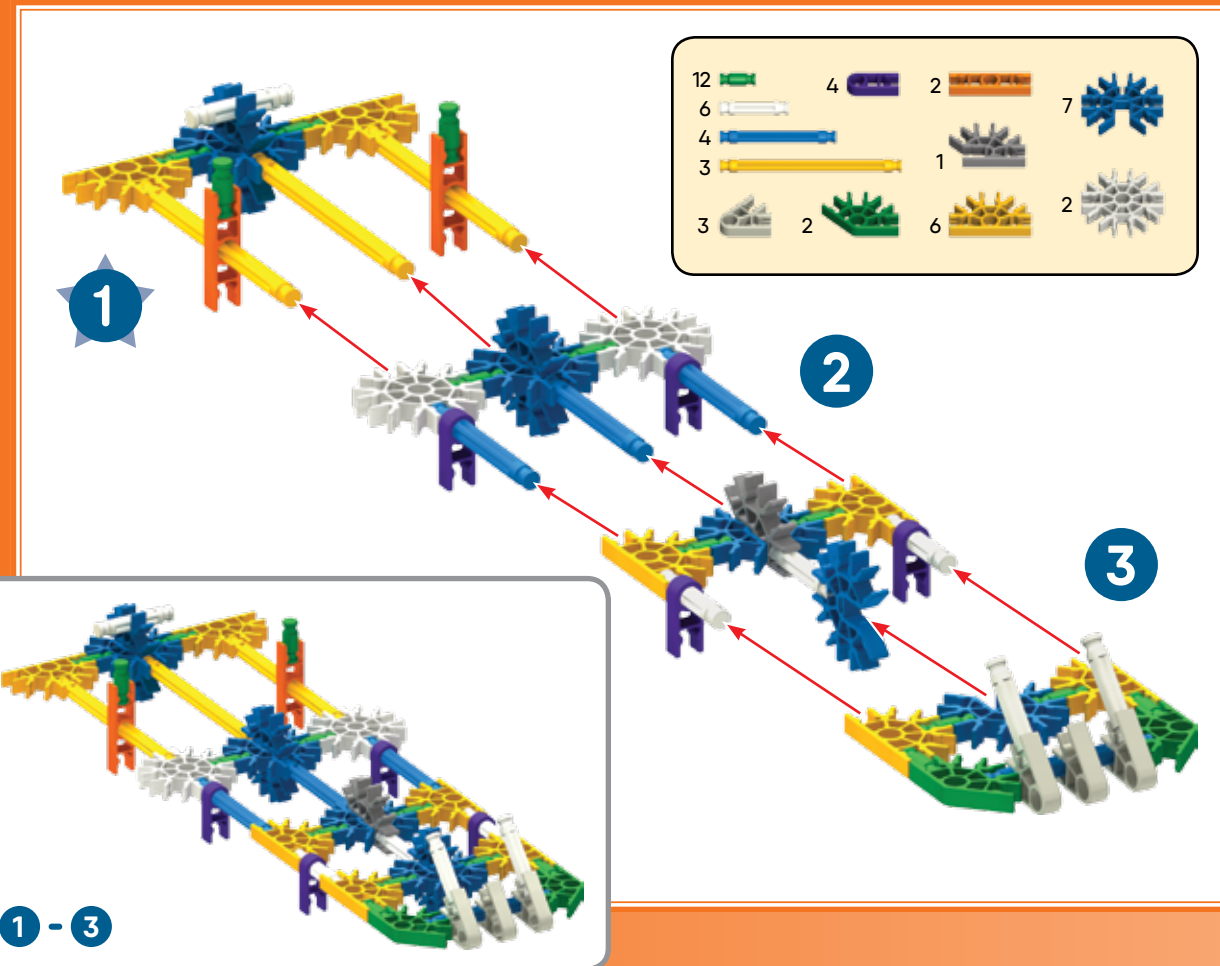
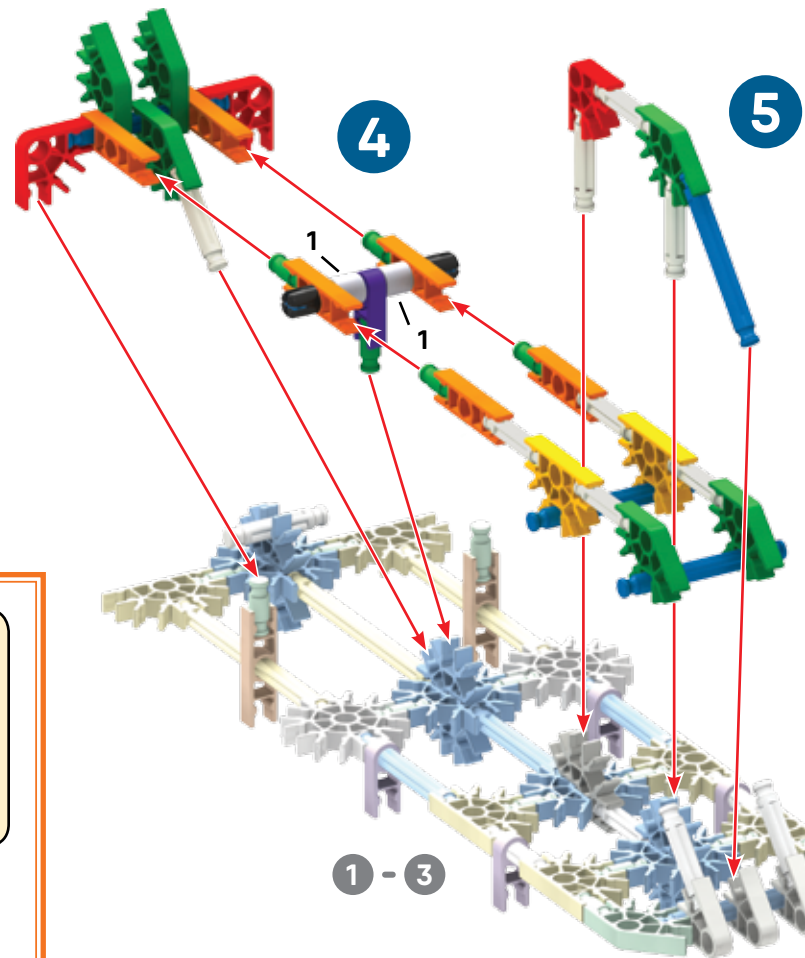

- | | | | | | | | |
|----|--|---|--|---|--|---|--|
| 12 | | 4 | | 2 | | 7 | |
| 6 | | | | | | | |
| 4 | | | | 1 | | | |
| 3 | | | | | | | |
| 3 | | 2 | | 6 | | 2 | |



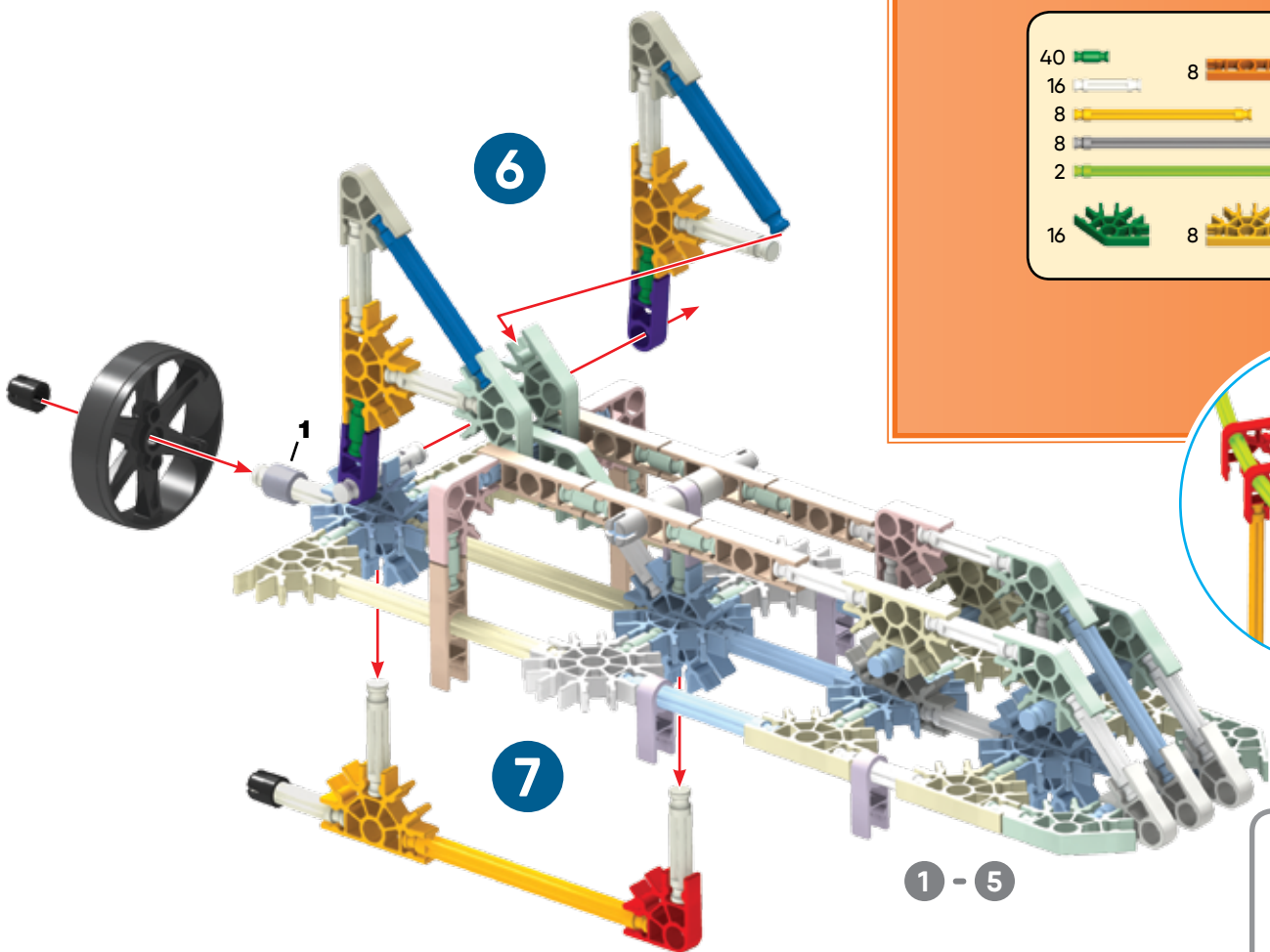

- | | | | | | |
|----|--|---|--|----|--|
| 40 | | 8 | | 16 | |
| 16 | | | | | |
| 8 | | | | | |
| 8 | | | | | |
| 2 | | | | | |
| 16 | | 8 | | 6 | |

1 - 5

- | | | | |
|---|--|---|--|
| 2 | | 2 | |
| 8 | | | |
| 2 | | 1 | |
| 1 | | | |
| 2 | | 2 | |
| 1 | | 3 | |
| 1 | | | |

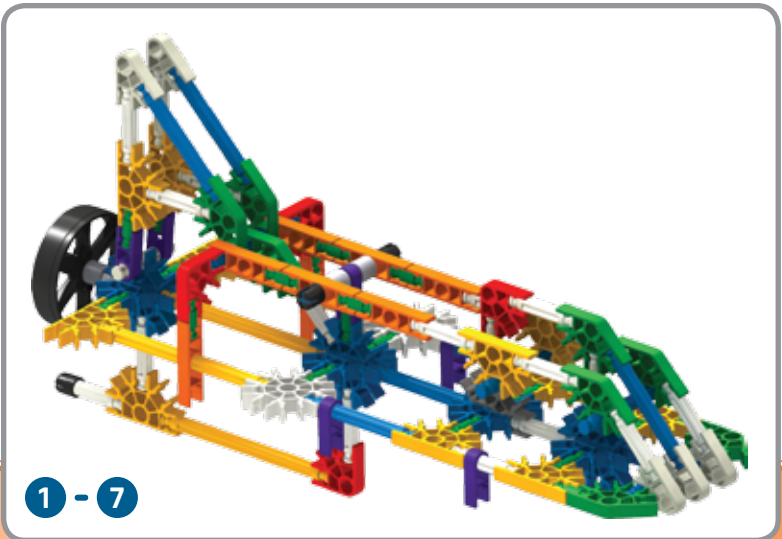

1 - 7

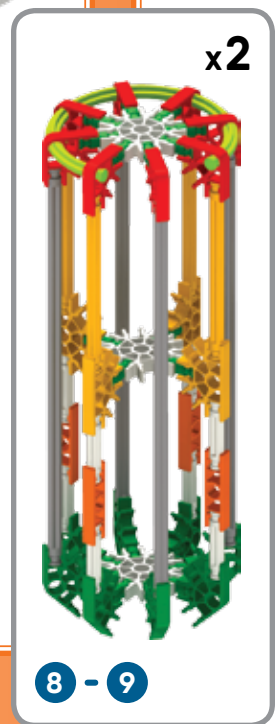

8 - 9

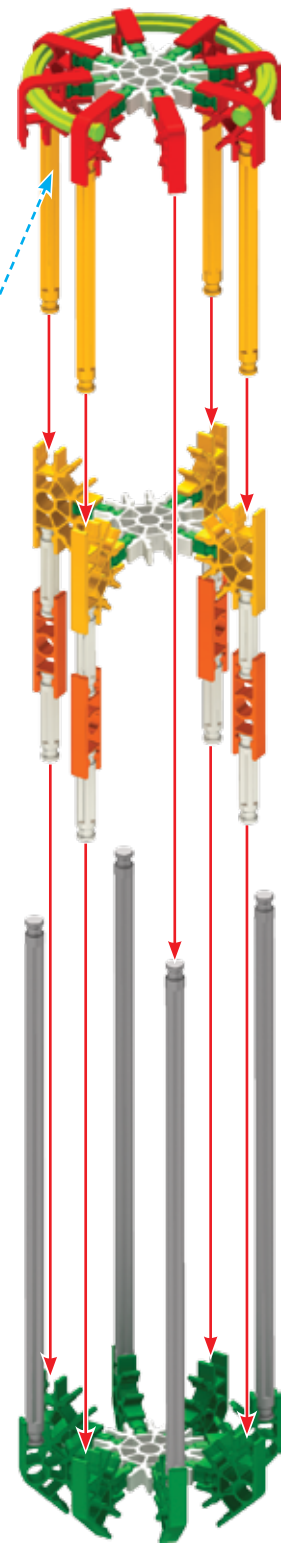

9

8

x2

x2

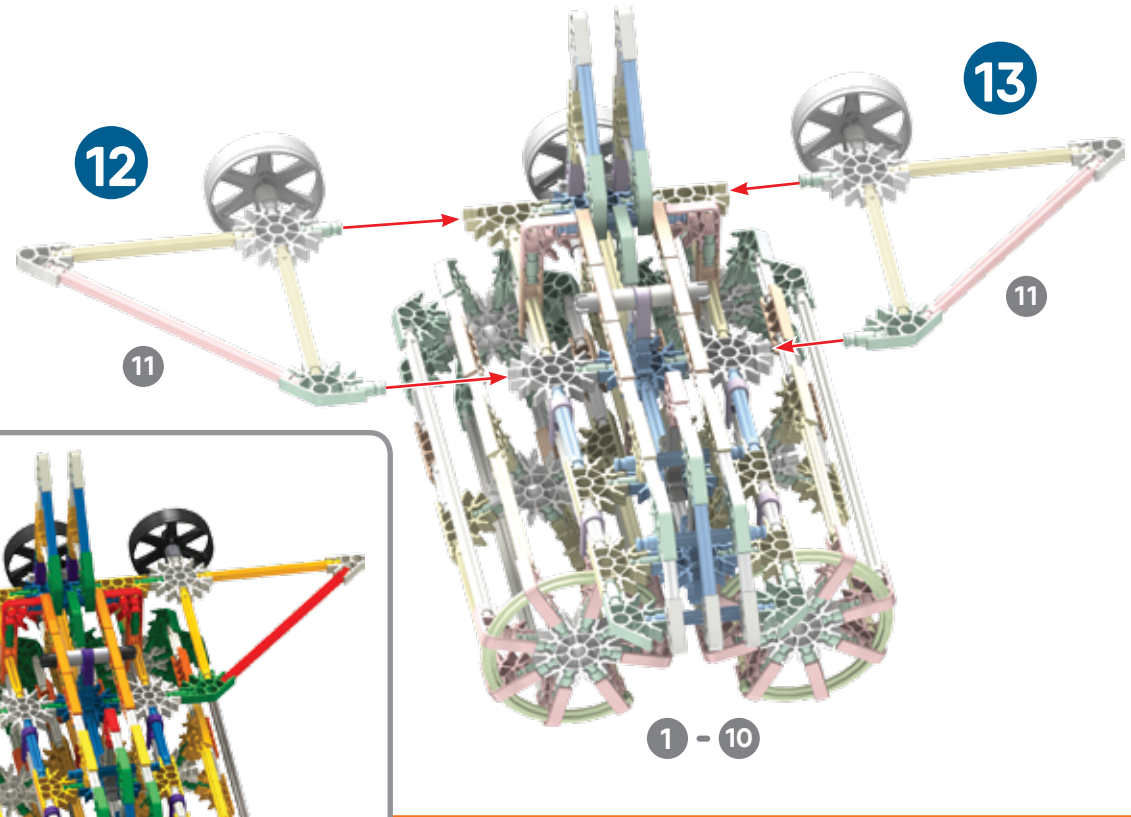
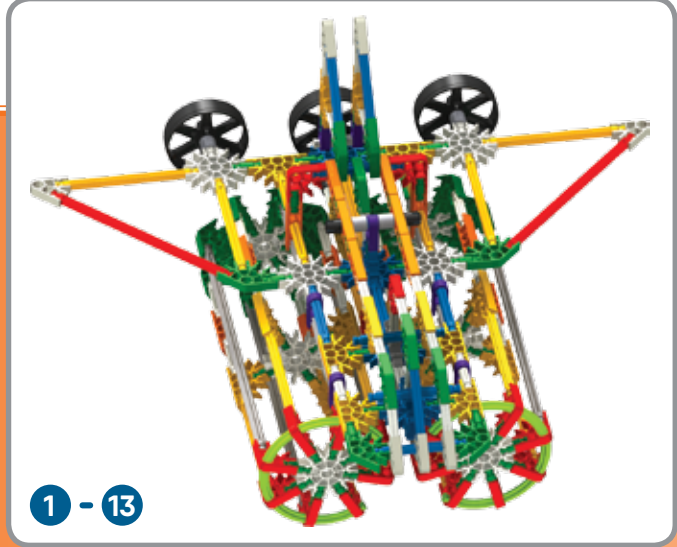
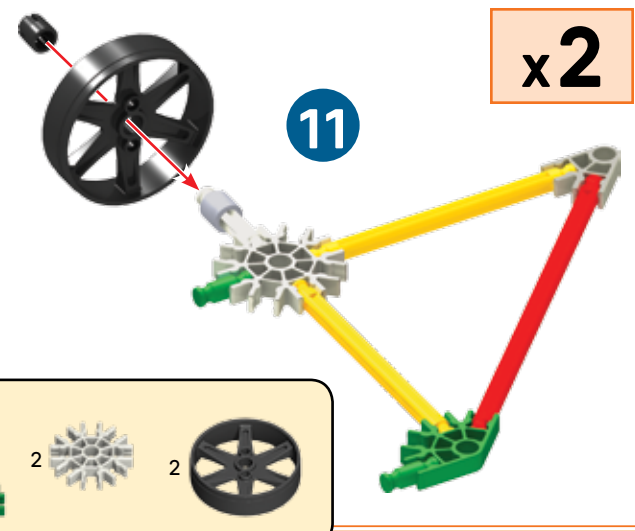
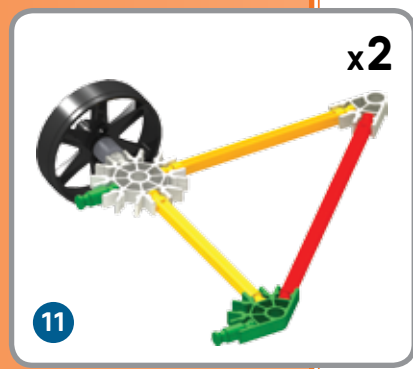
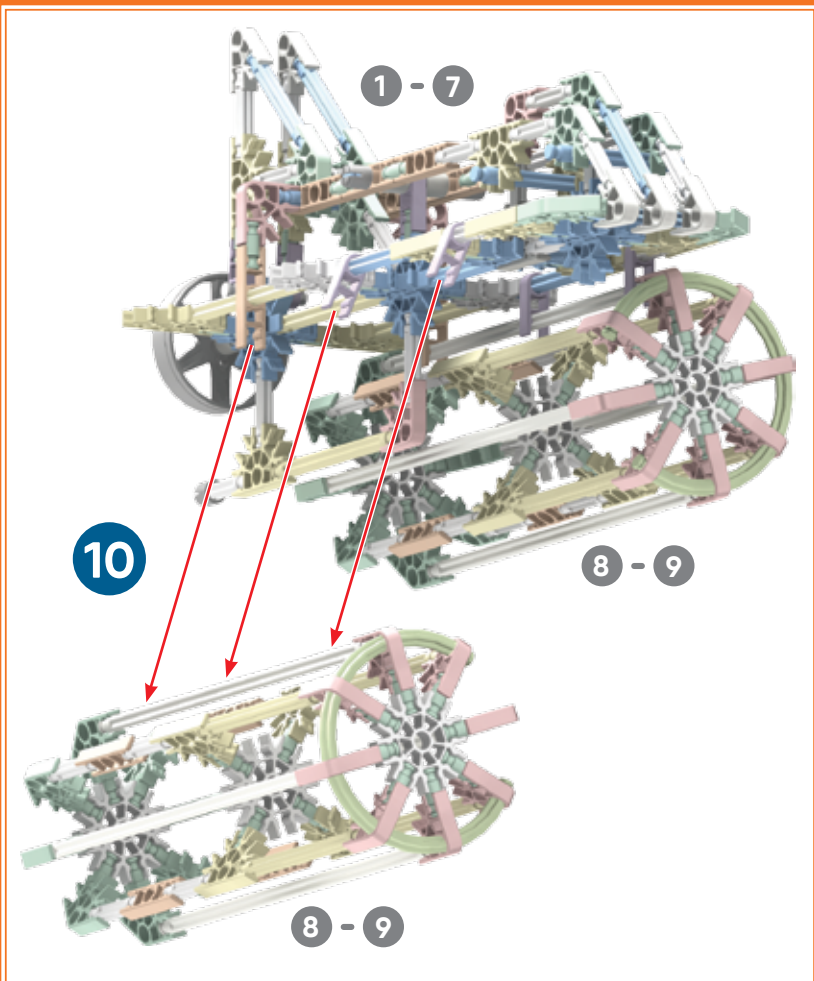

**Eiffel
Tower
La tour
Eiffel**

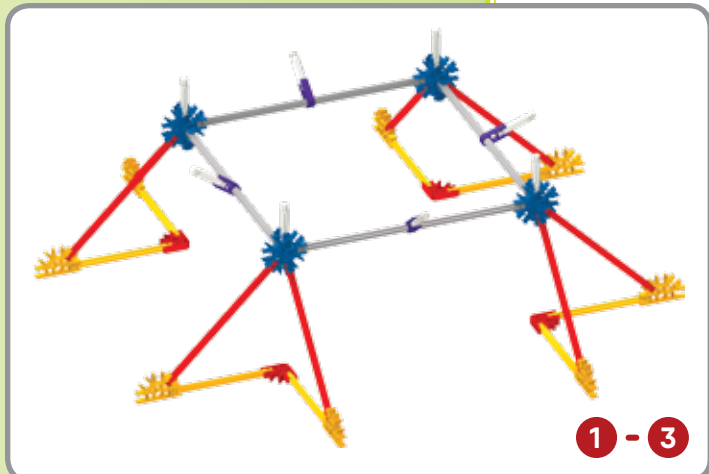
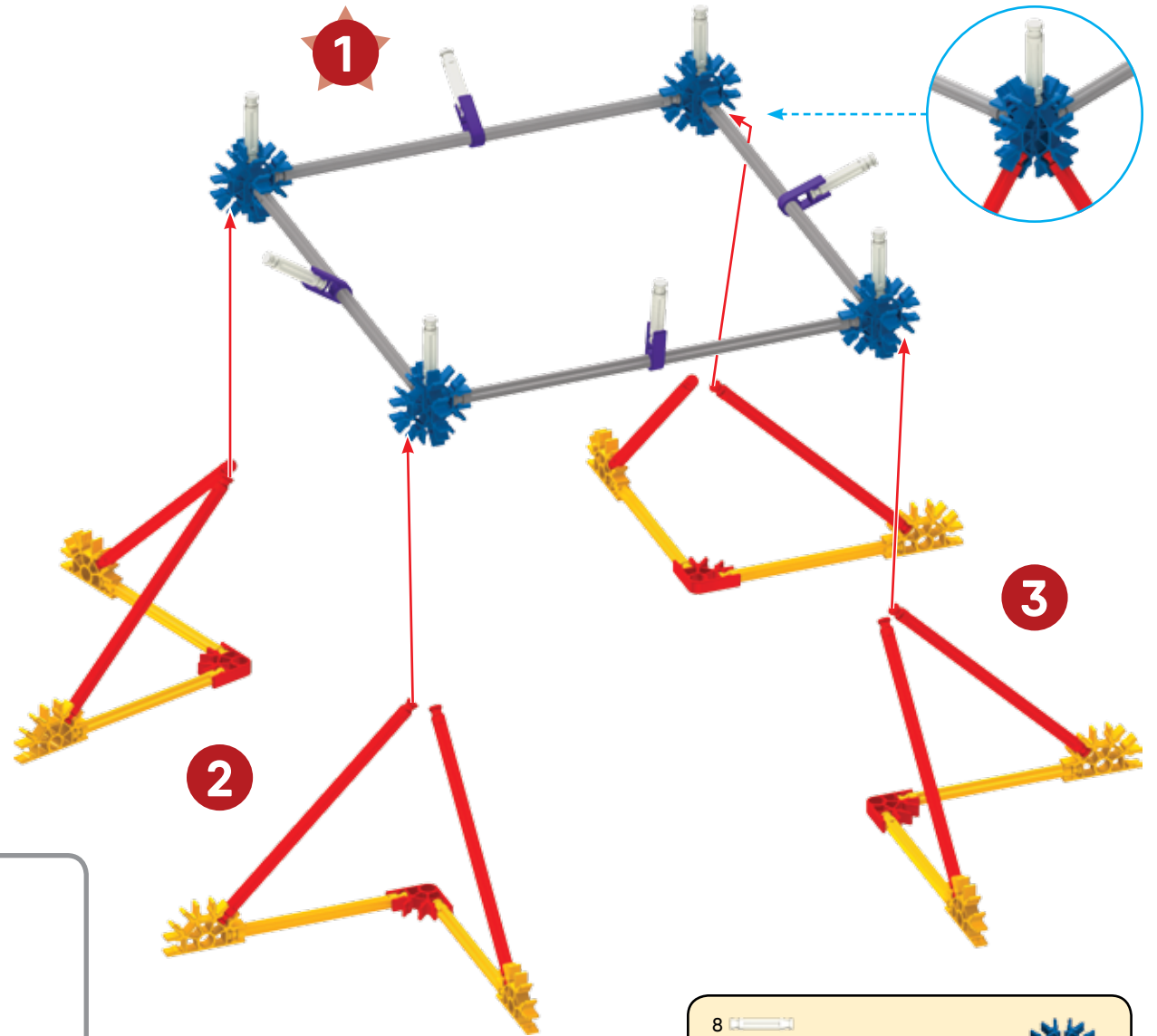
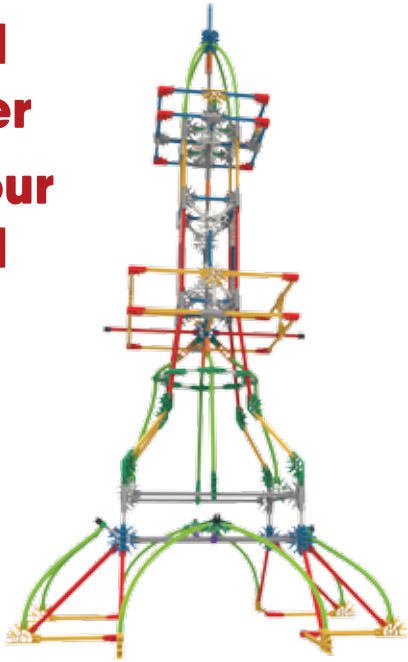

- | | | | |
|---|--|---|--|
| 8 | | | |
| 8 | | 8 | |
| 8 | | | |
| 4 | | | |
| 4 | | 4 | |
| | | 8 | |

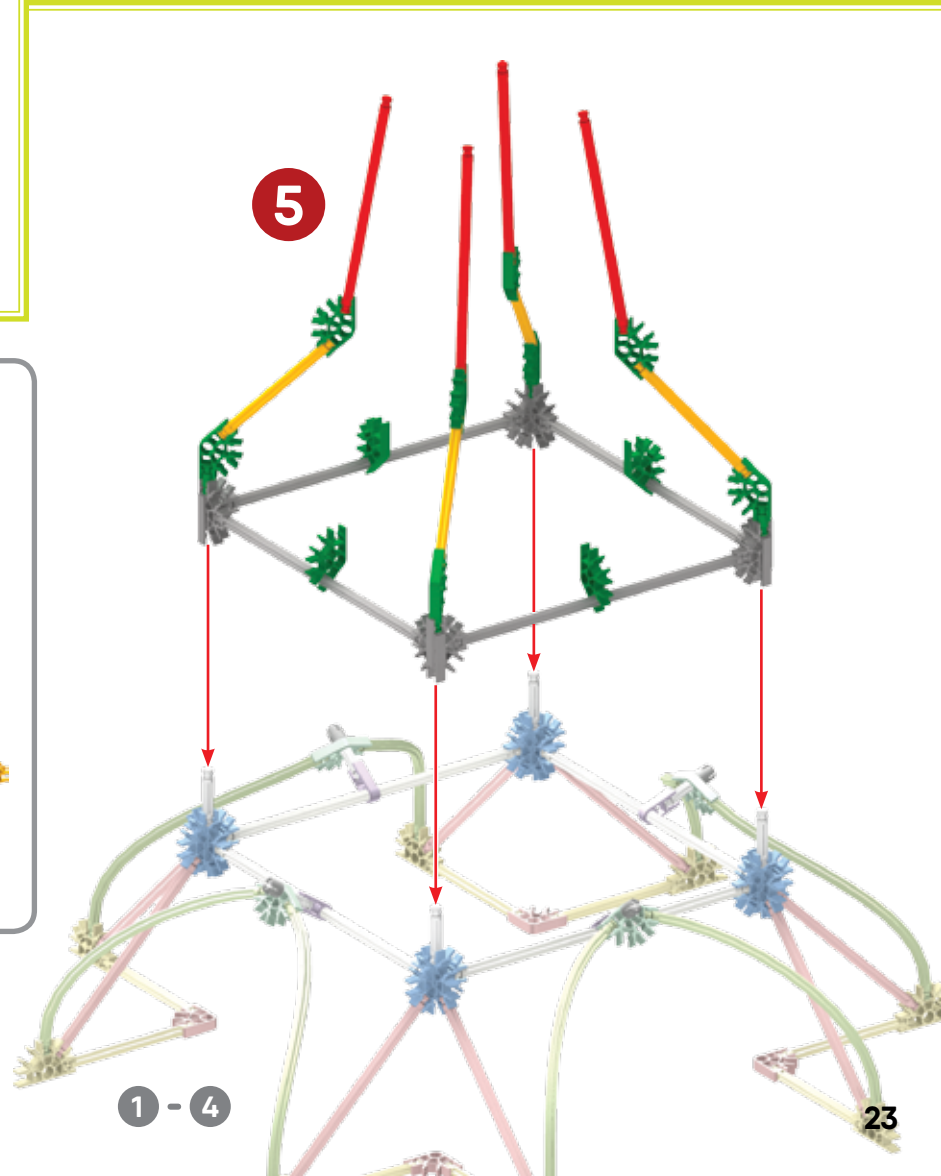
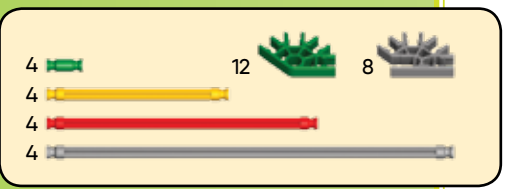
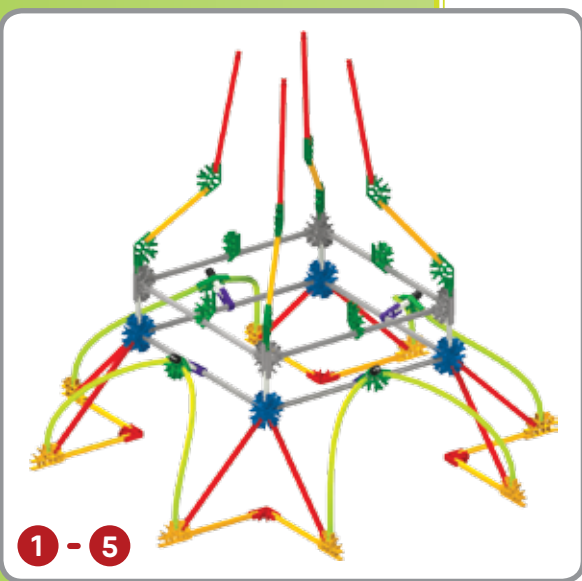
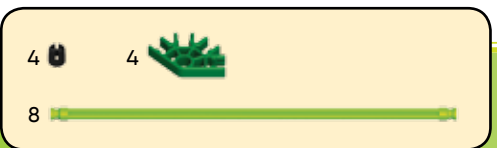
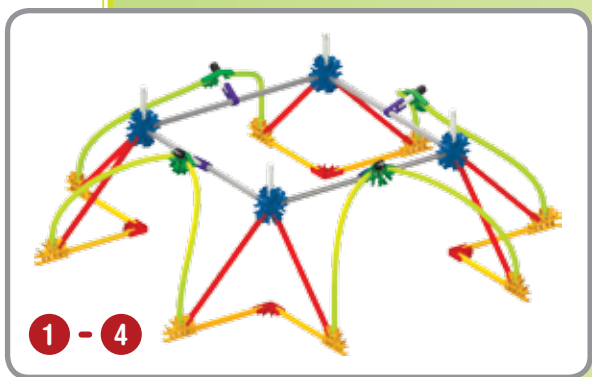
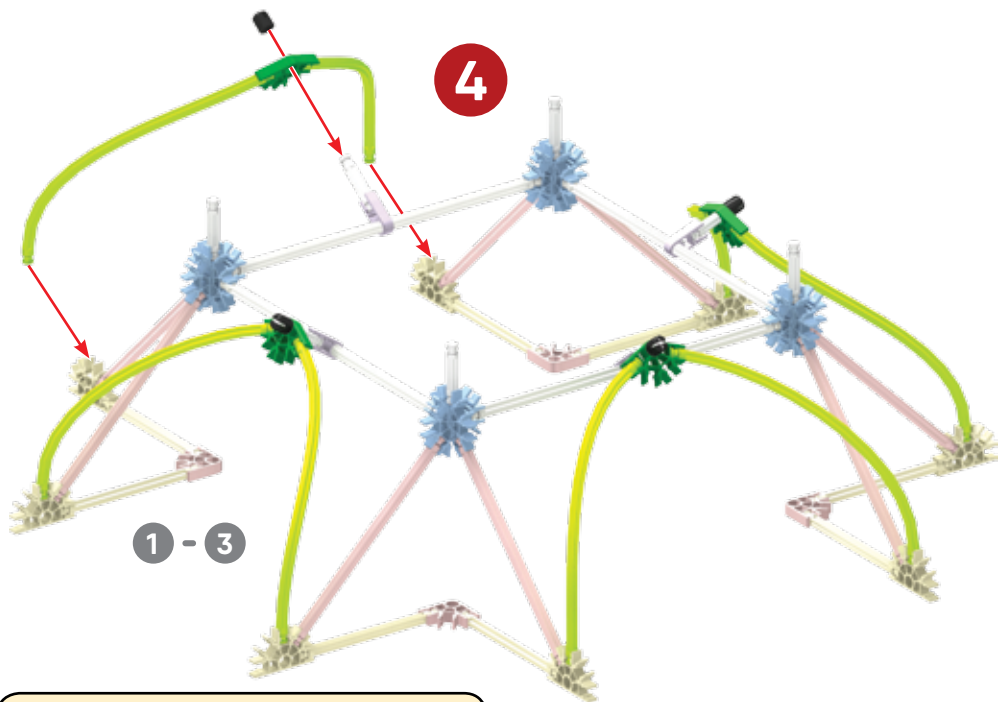

6

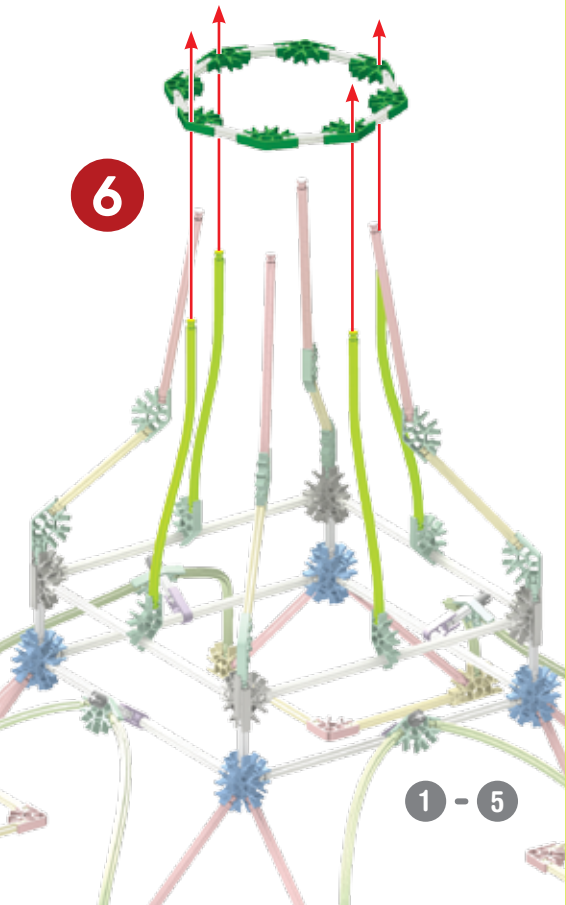

1 - 5

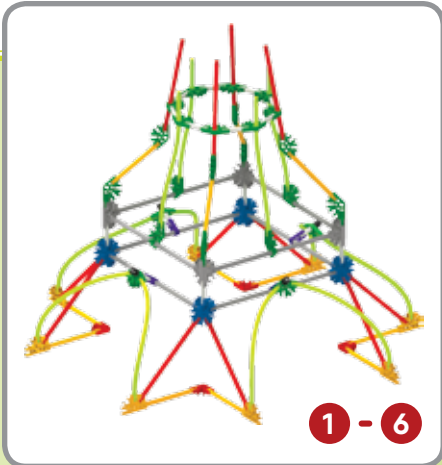
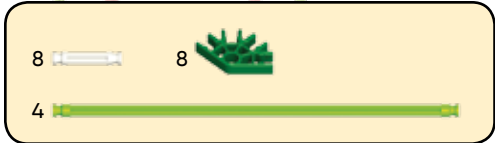

1 - 6

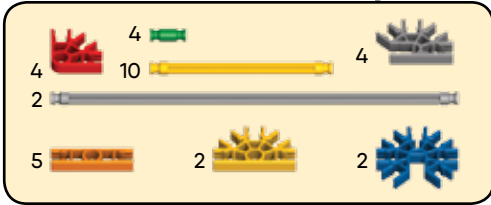

7

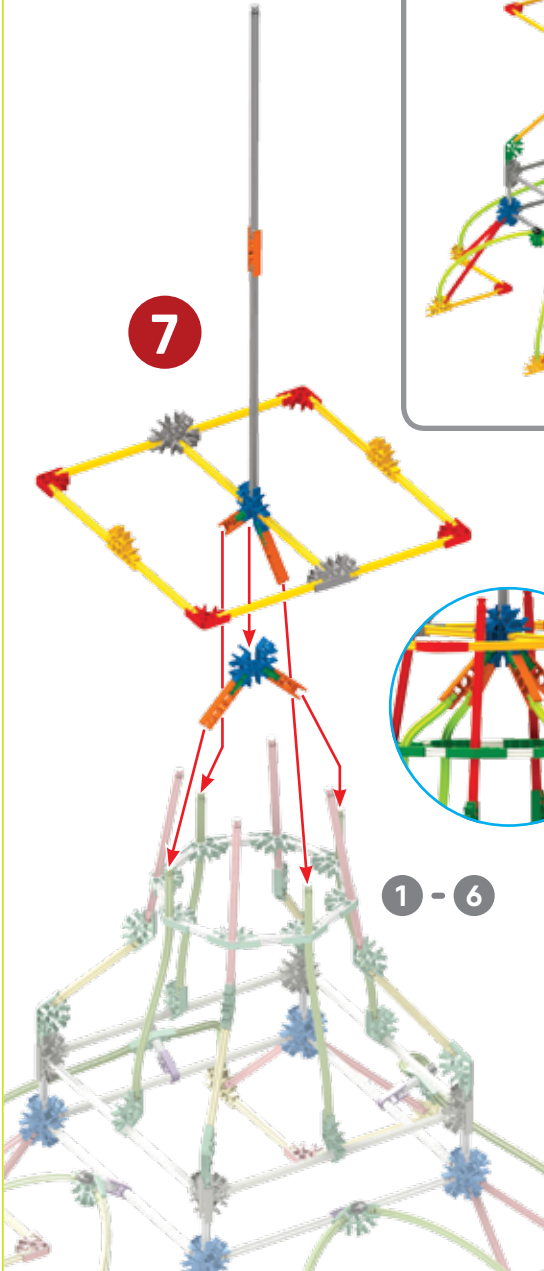

1 - 6

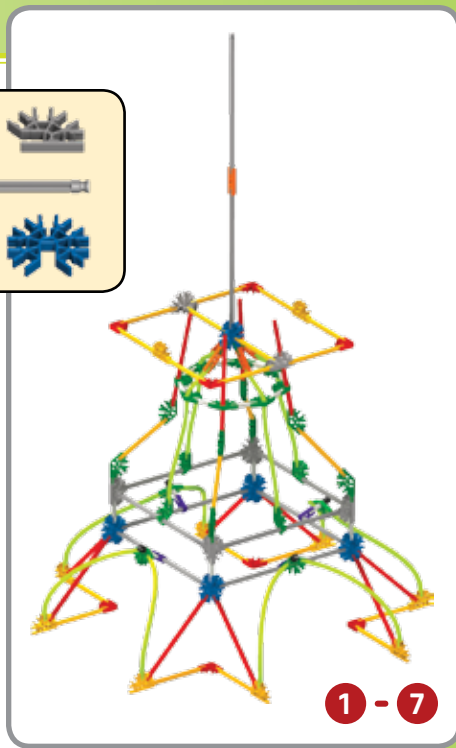

1 - 7

8

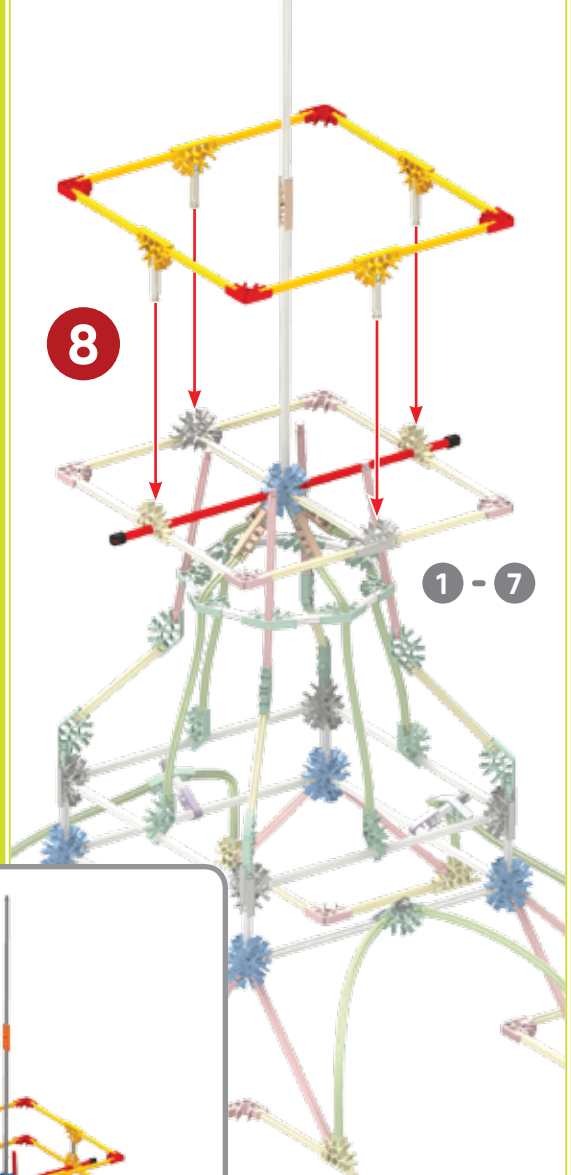

1 - 7

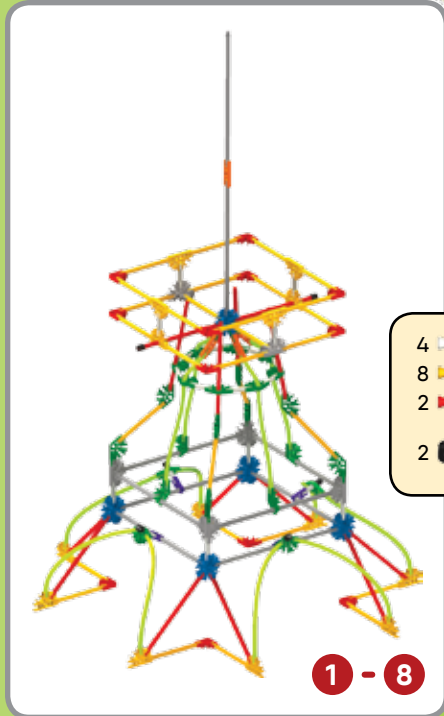
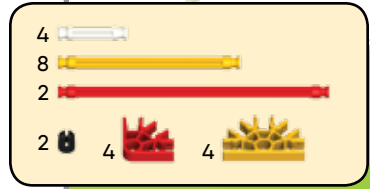

1 - 8

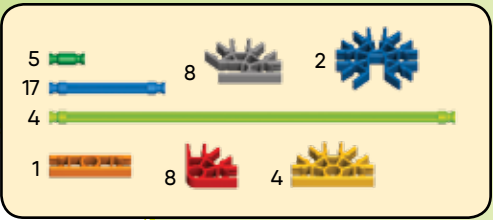

10

9

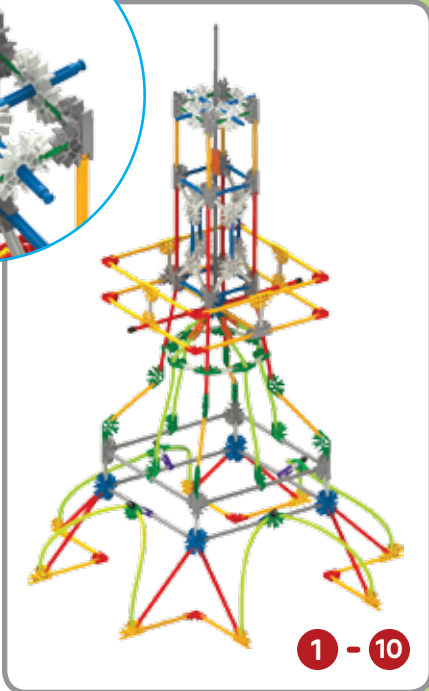

1 - 10

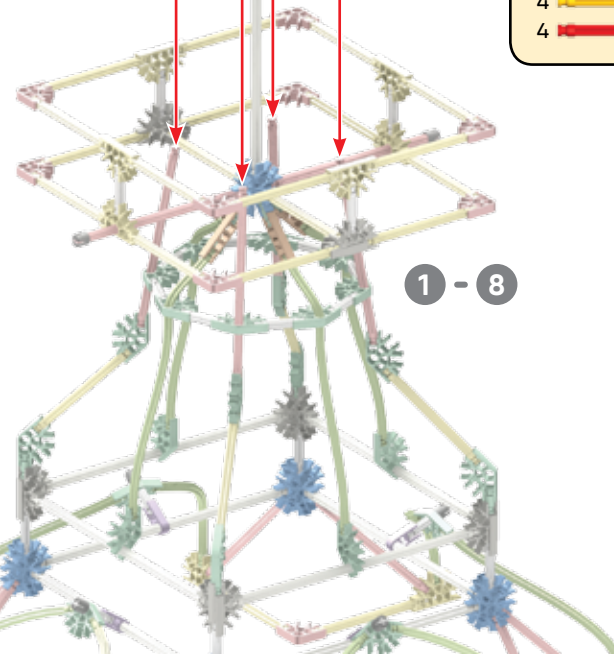
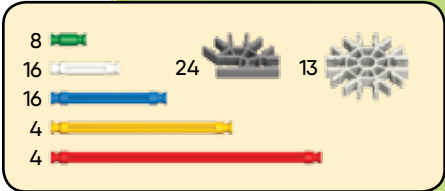

1 - 8

12

11

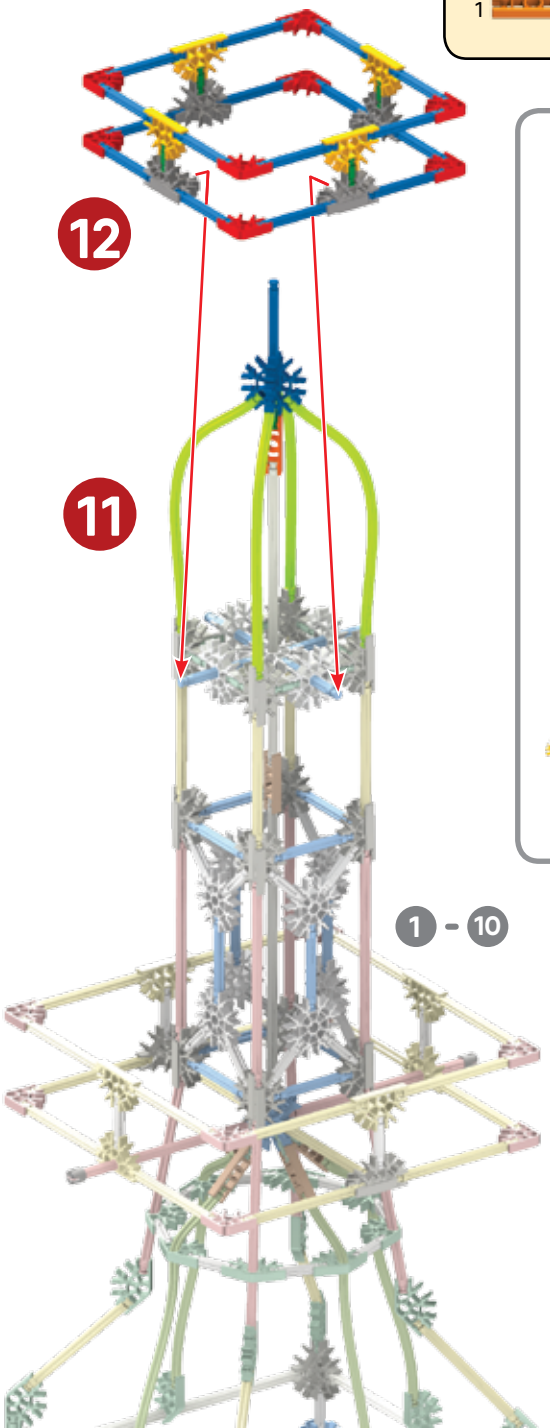

1 - 10

1 - 12

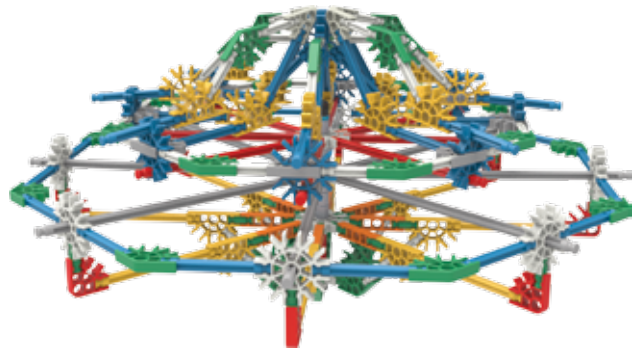

Flying Saucer Soucoupe volante

x8

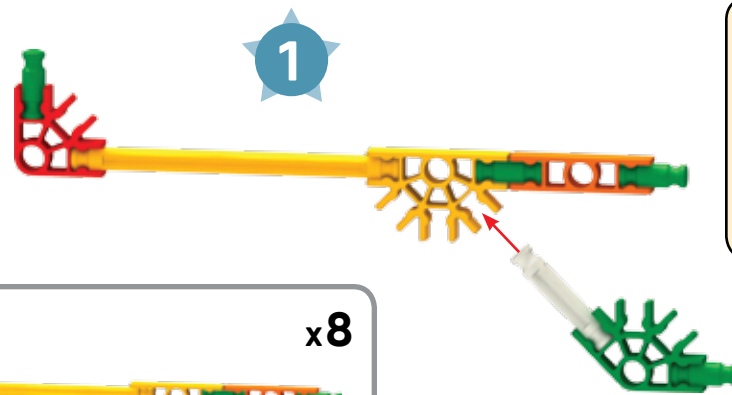

32	
8	
8	
8	
8	
8	
8	

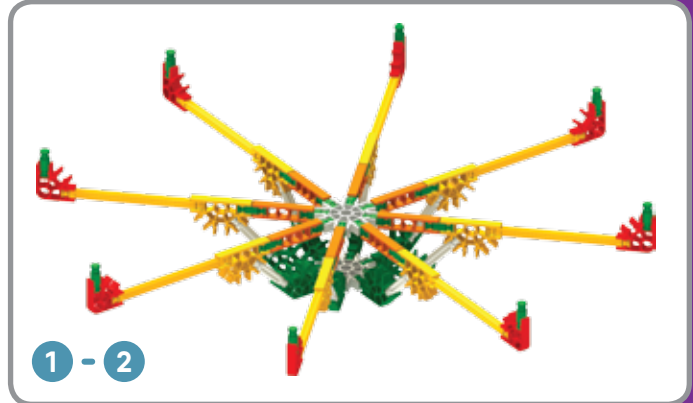
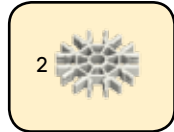
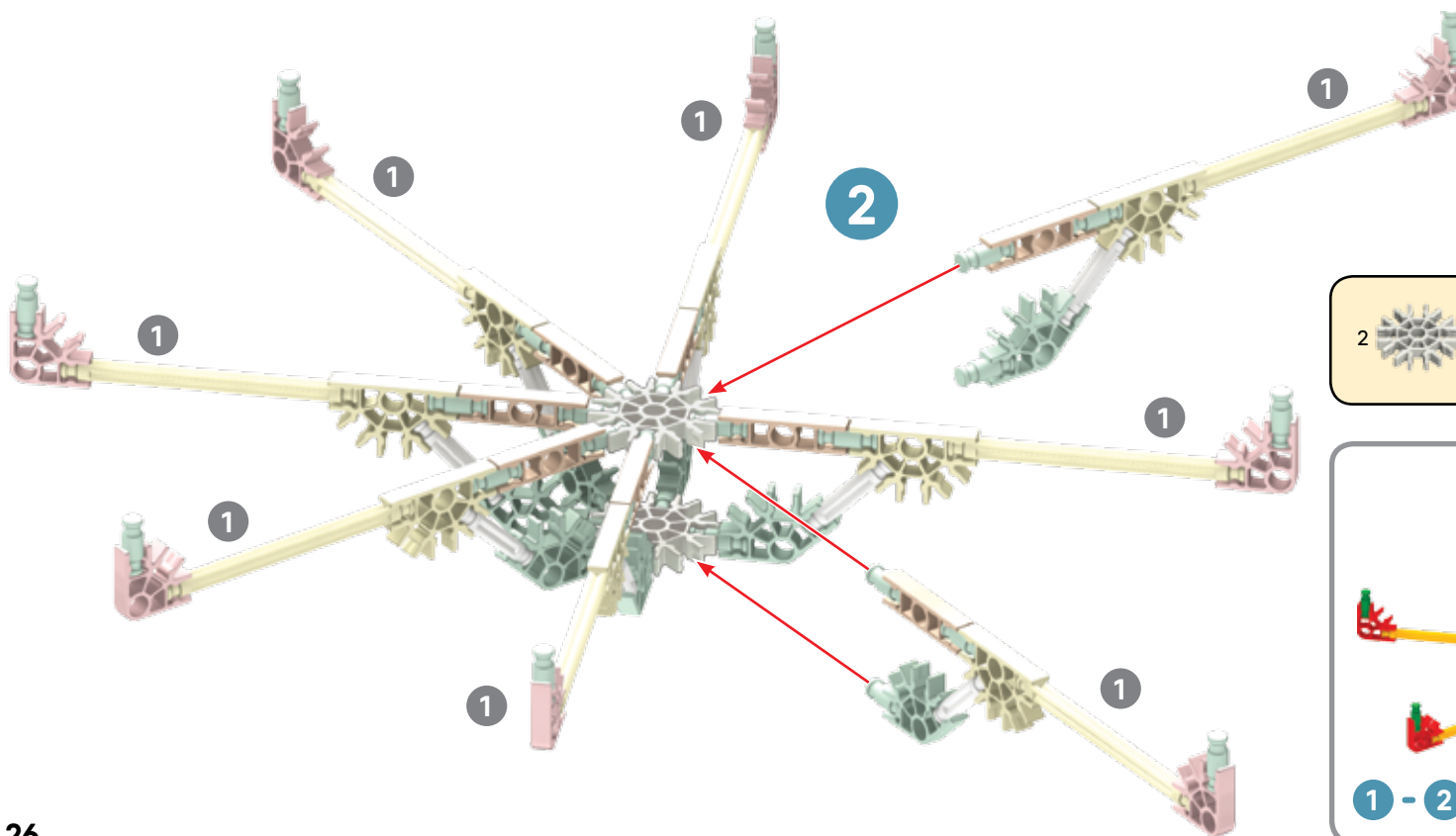
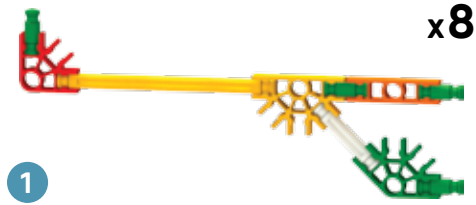

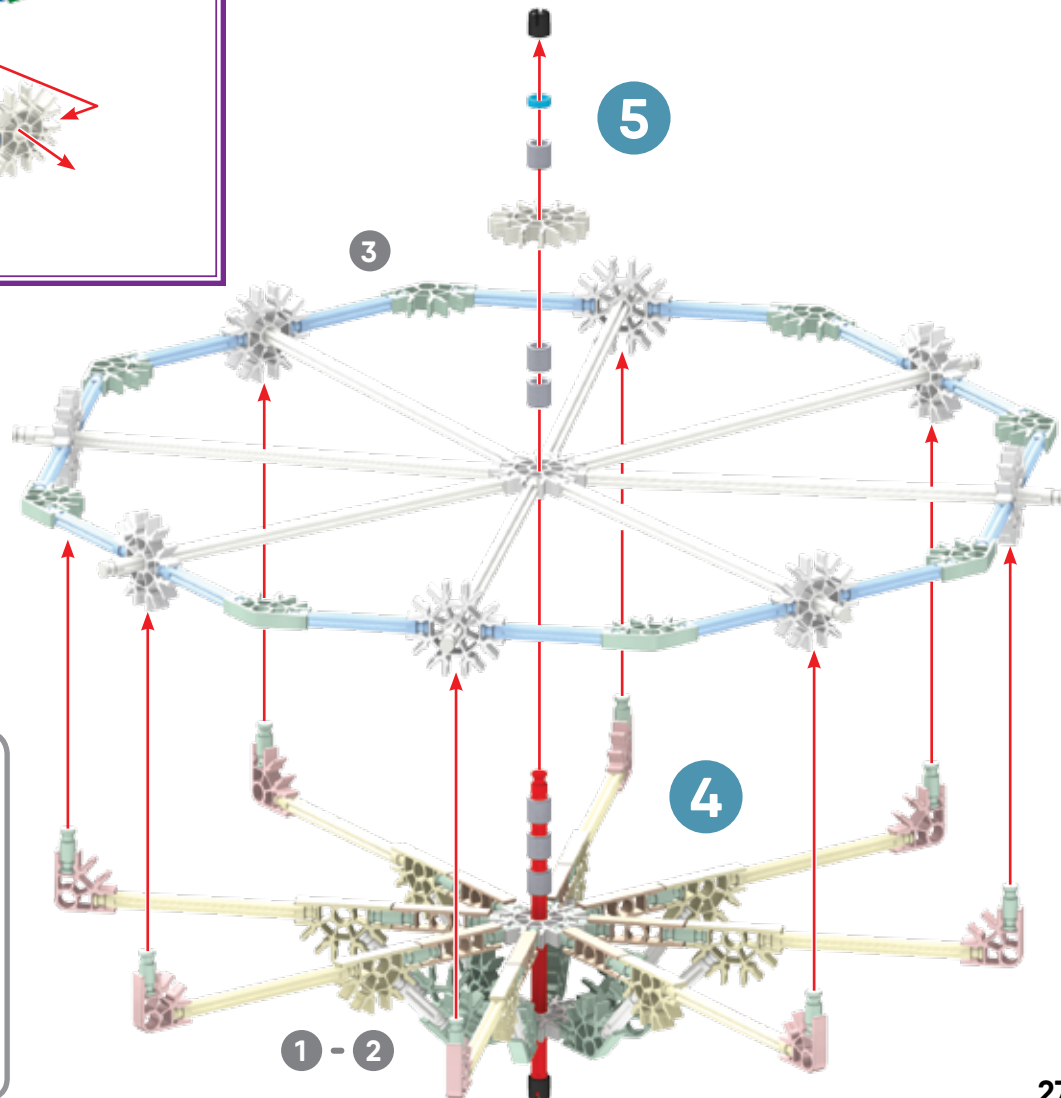
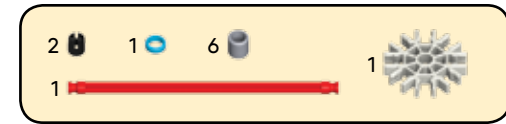
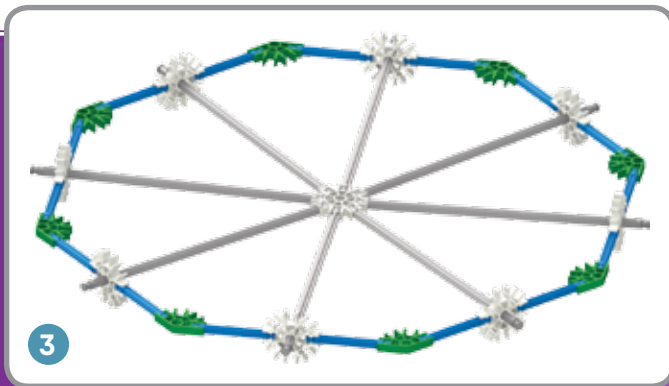
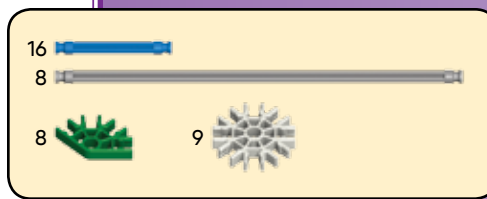
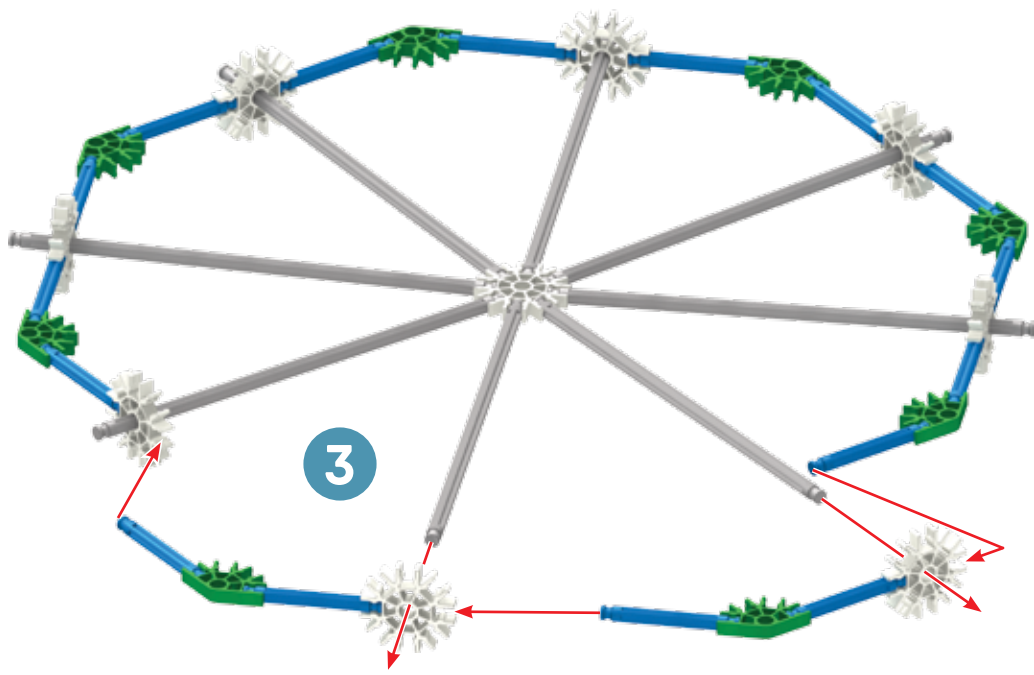

x4

6

16		8	
12		4	
12		4	

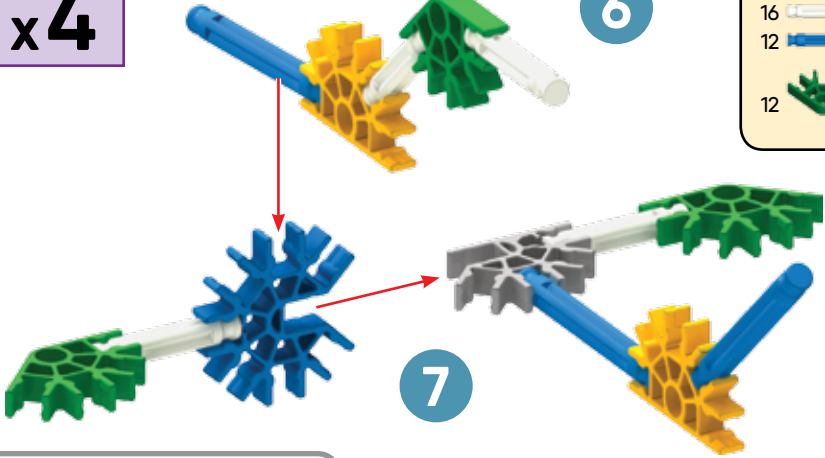

7

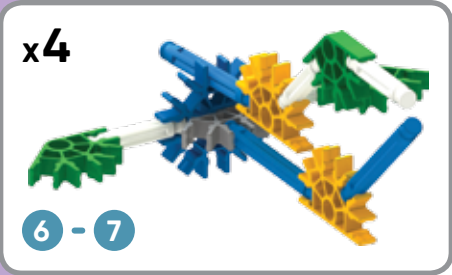

6 - 7

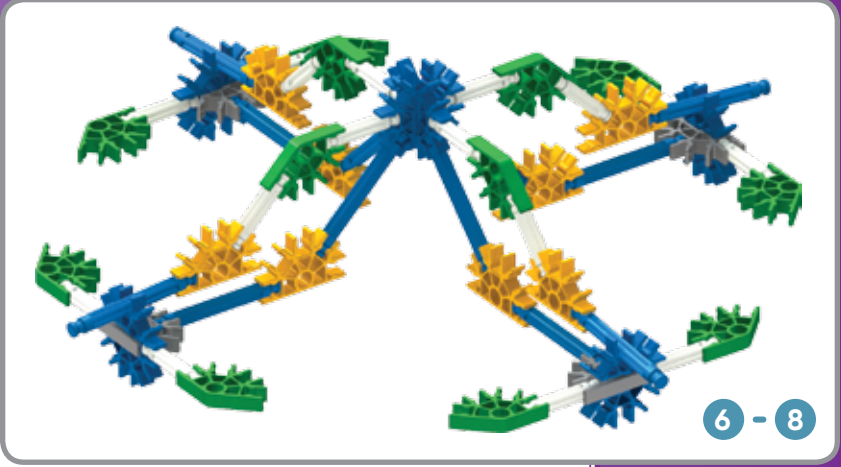

6 - 8

8

2

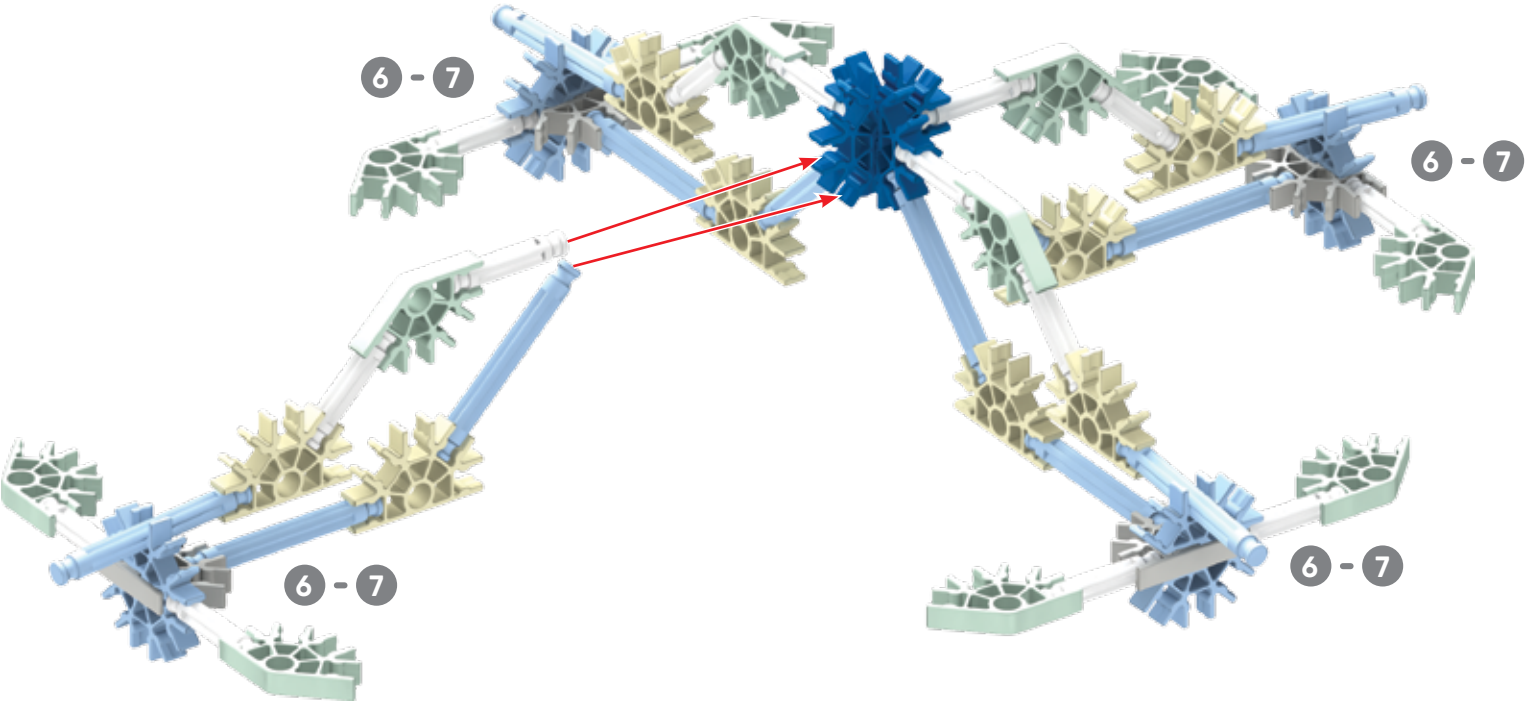

6 - 7

6 - 7

6 - 7

6 - 7

x4

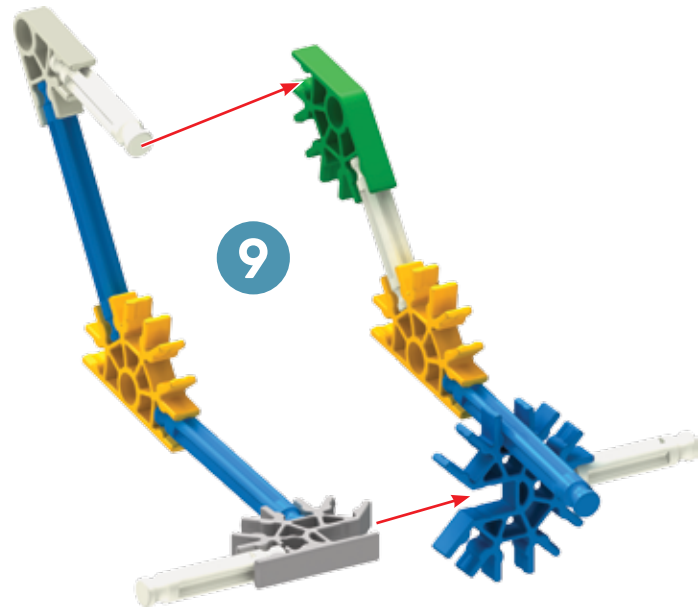

9



x4

9

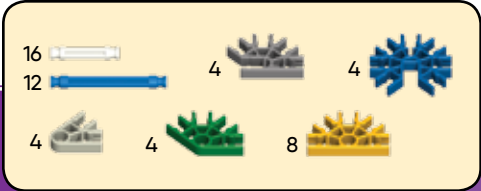

10

9

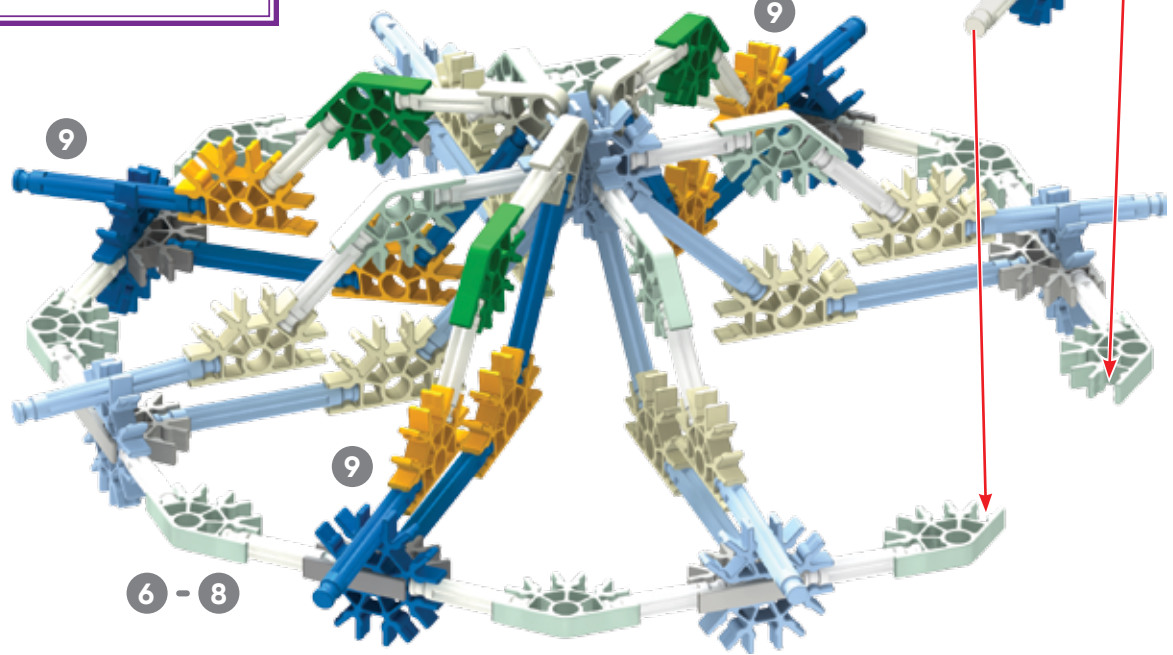

9

9

6 - 8

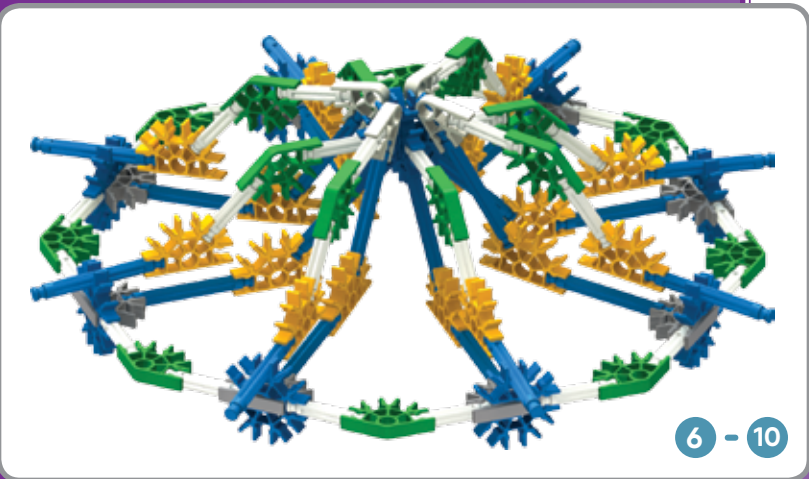

6 - 10

6 - 10

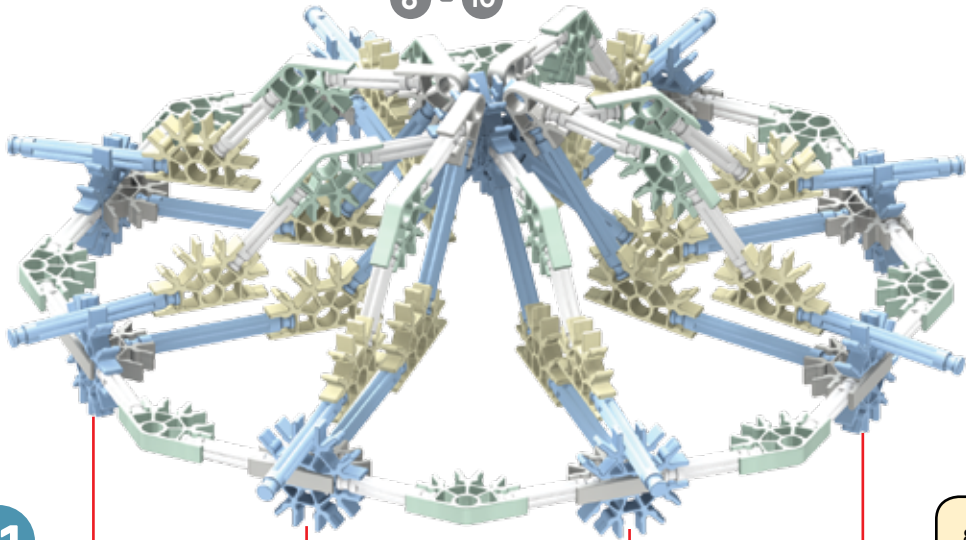

11

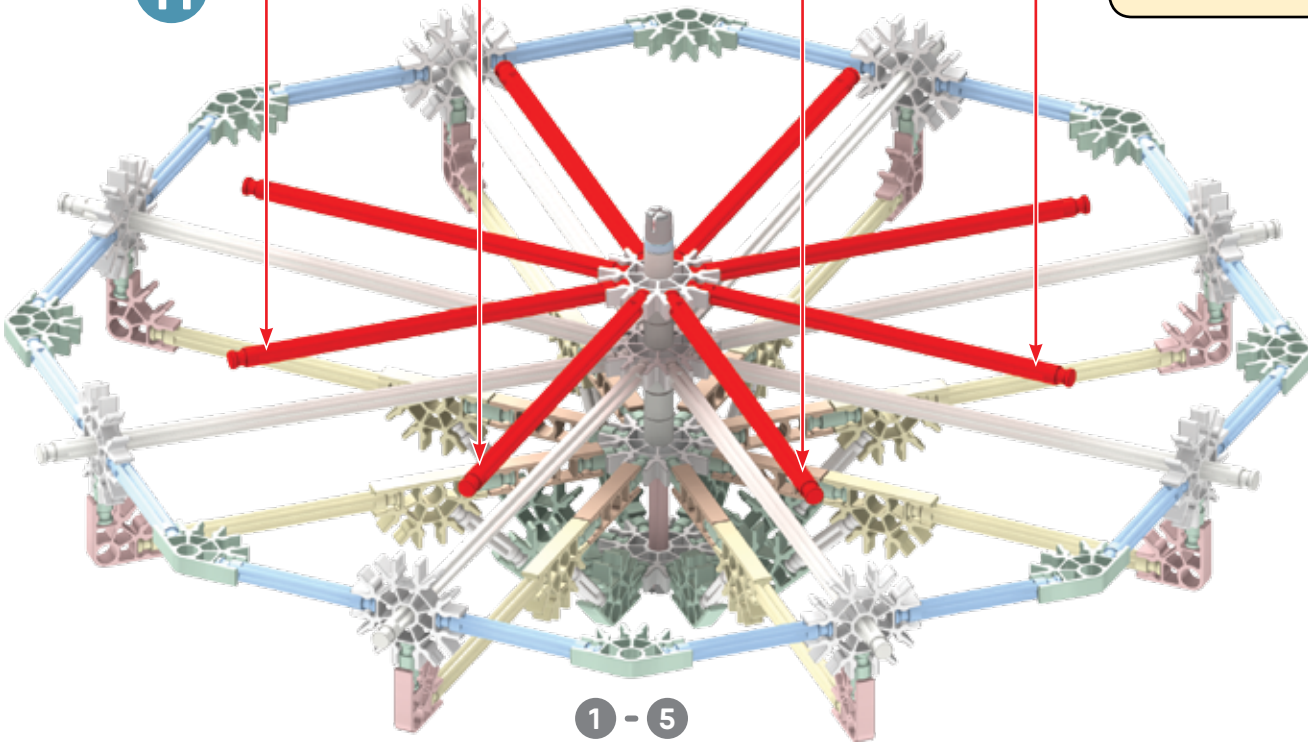

1 - 5



1 - 11

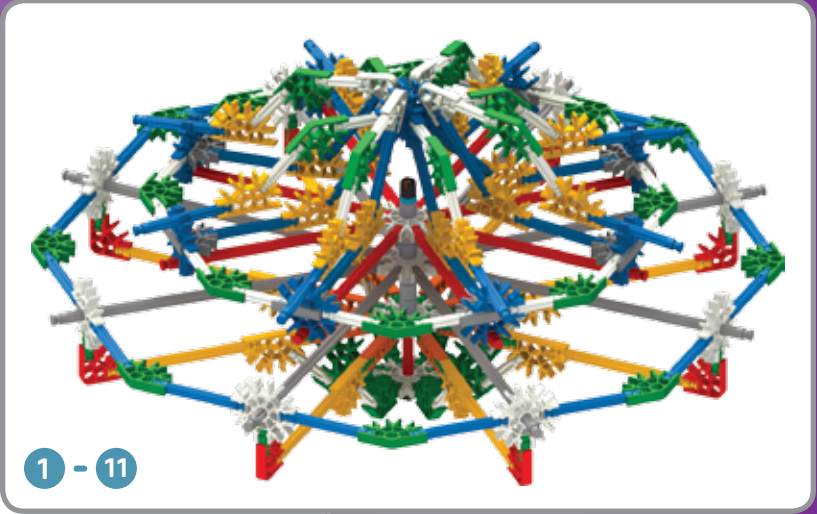

Pod Spinner Radar tournant

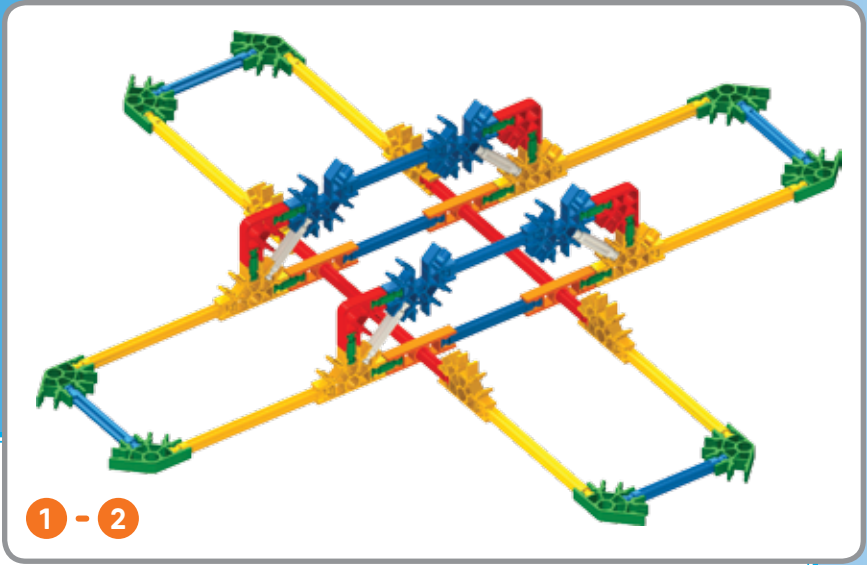

1 - 2

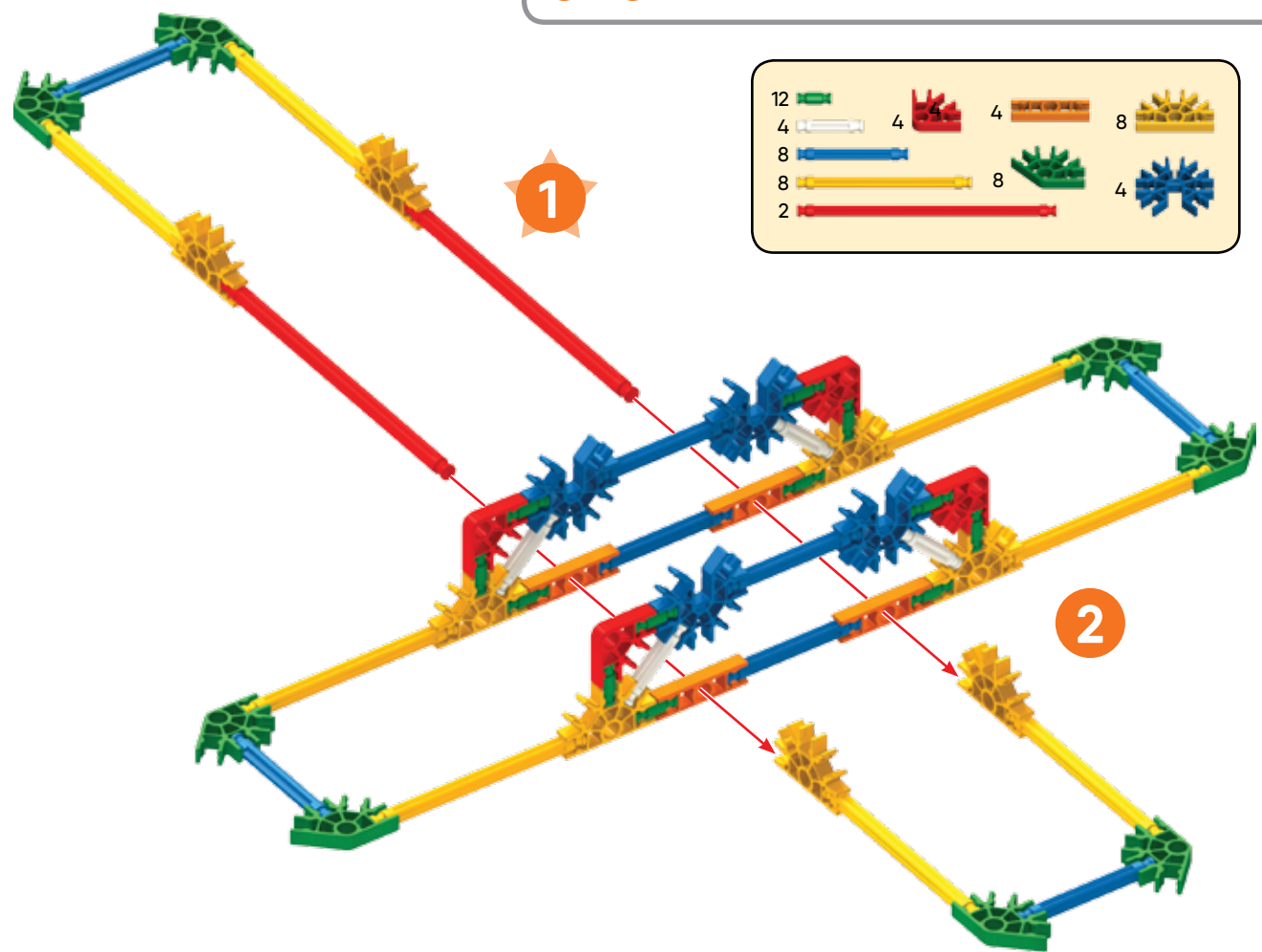

12		4		4		8	
4		4		4		8	
8		8		8		4	
8		8		8		4	
2		8		8		4	

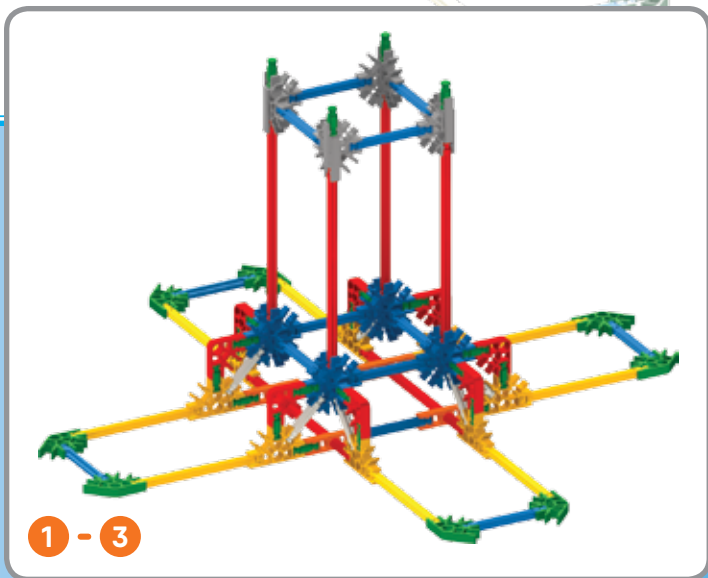
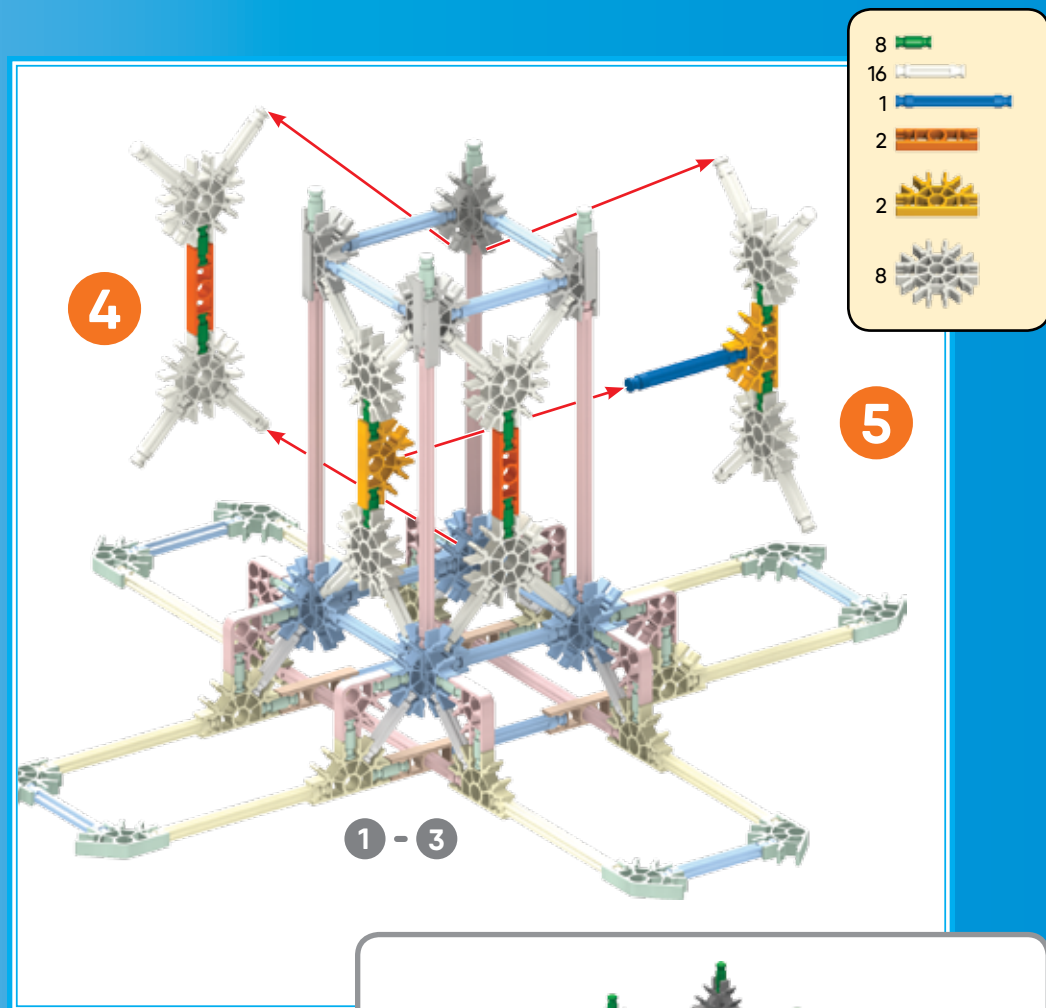
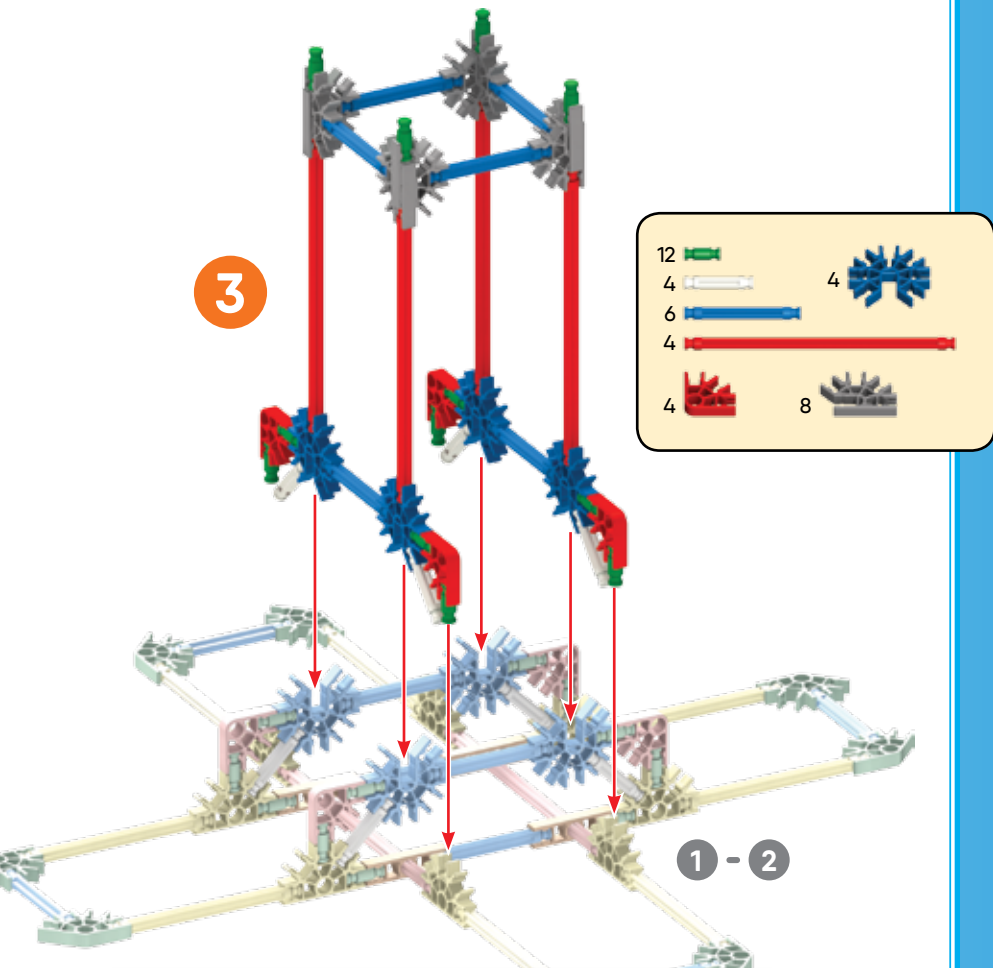

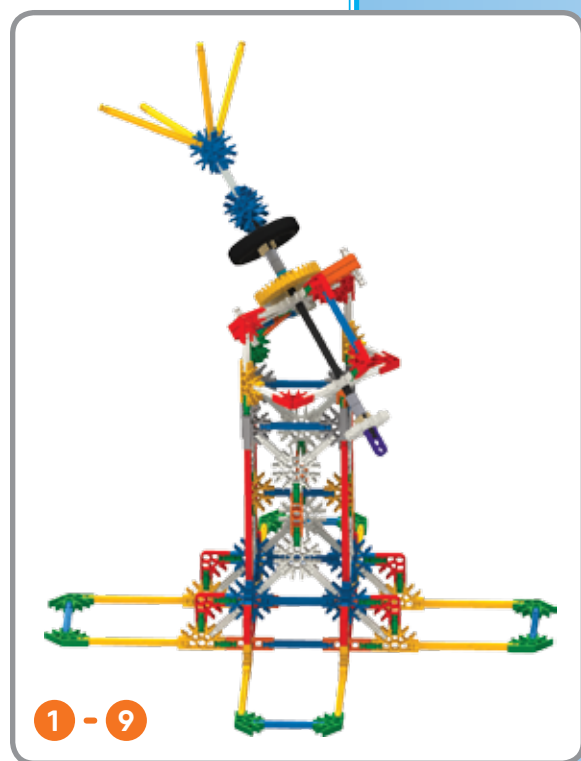
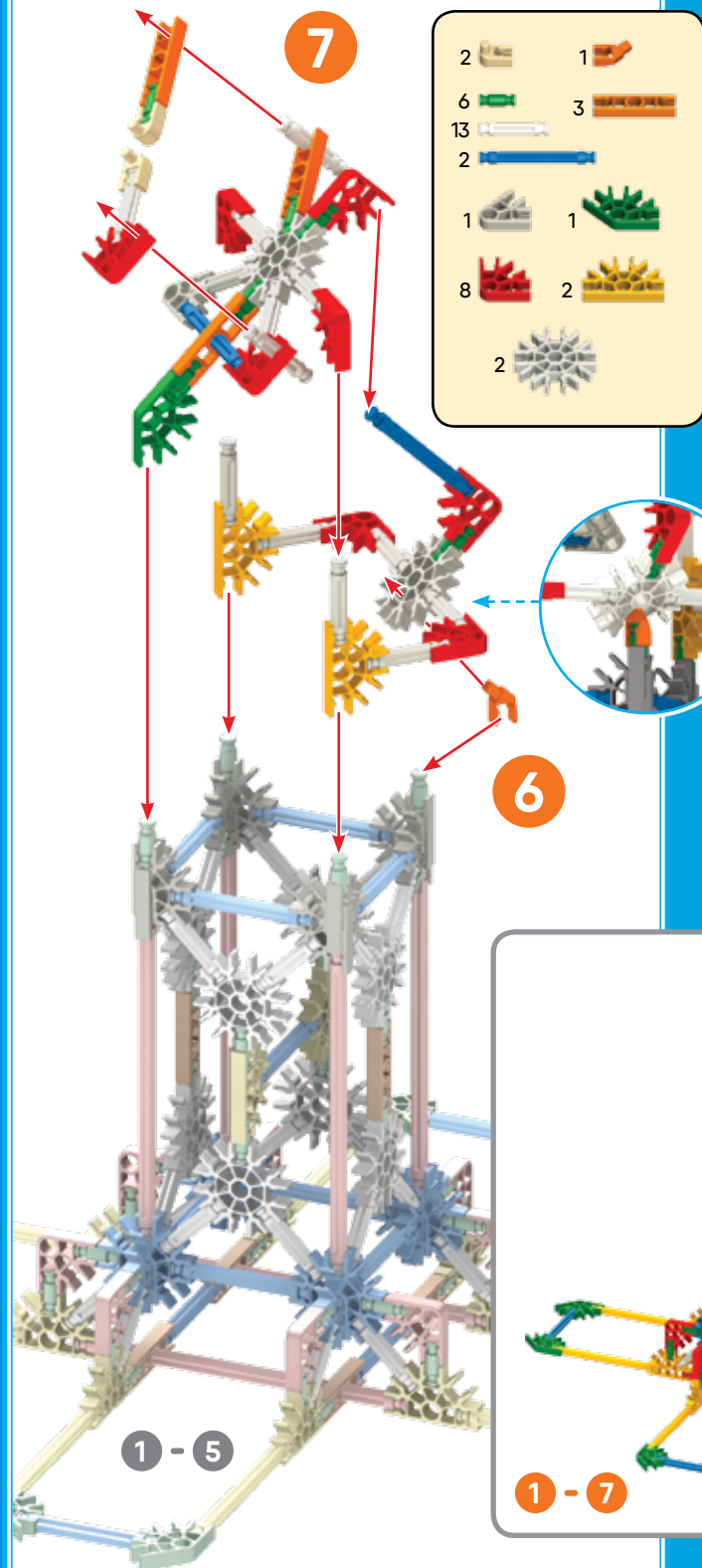

x4

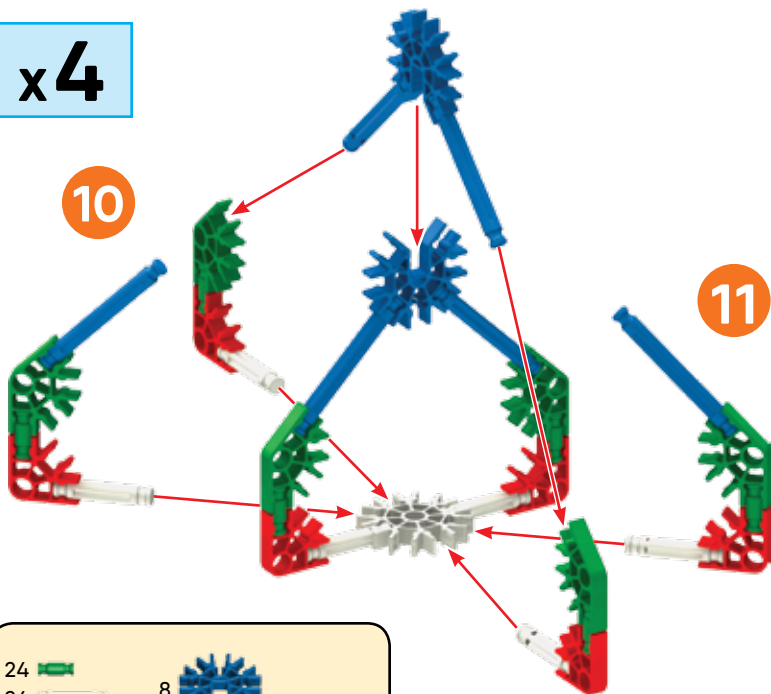

- 24
- 24
- 24
- 24
- 24
- 8
- 4



10 - 11

- 12
- 12
- 12
- 8
- 4
- 4
- 4
- 4
- 4
- 16
- 4
- 4
- 4
- 8
- 8
- 4
- 4
- 4

x4

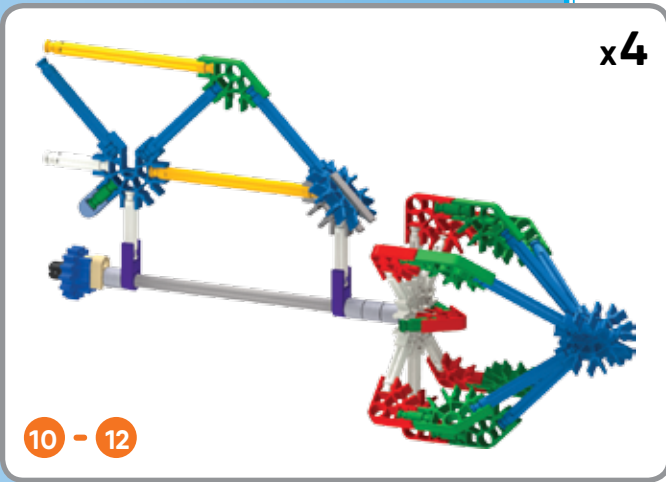

10 - 12

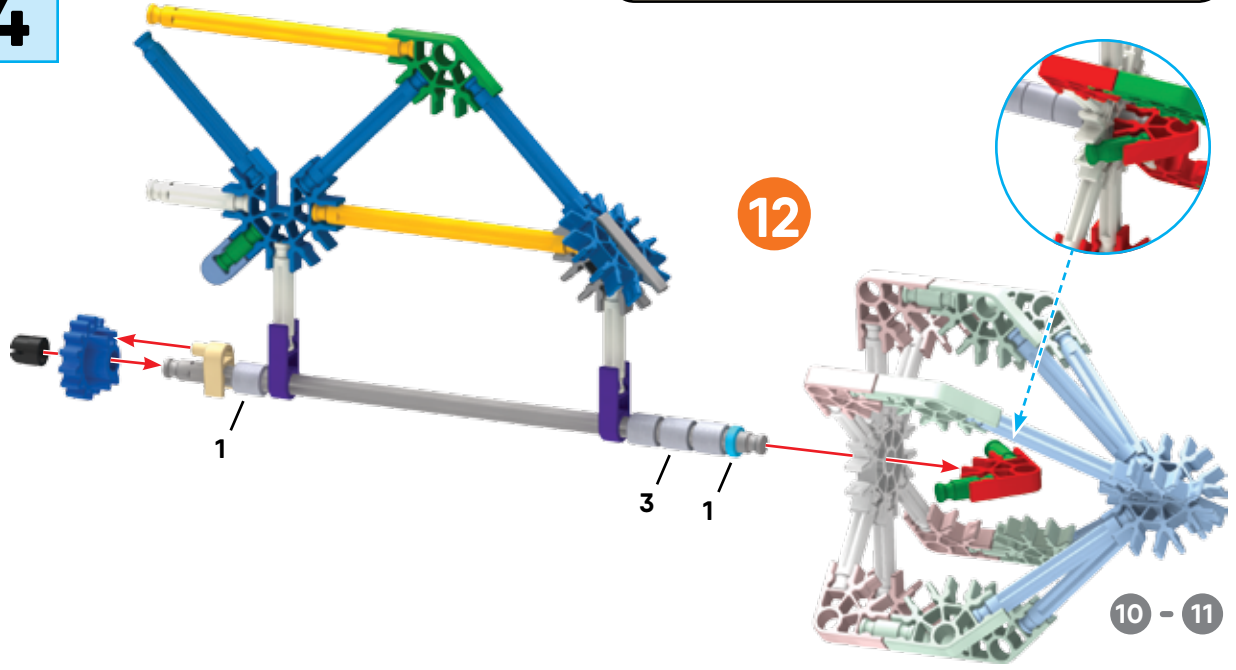

12

10 - 11

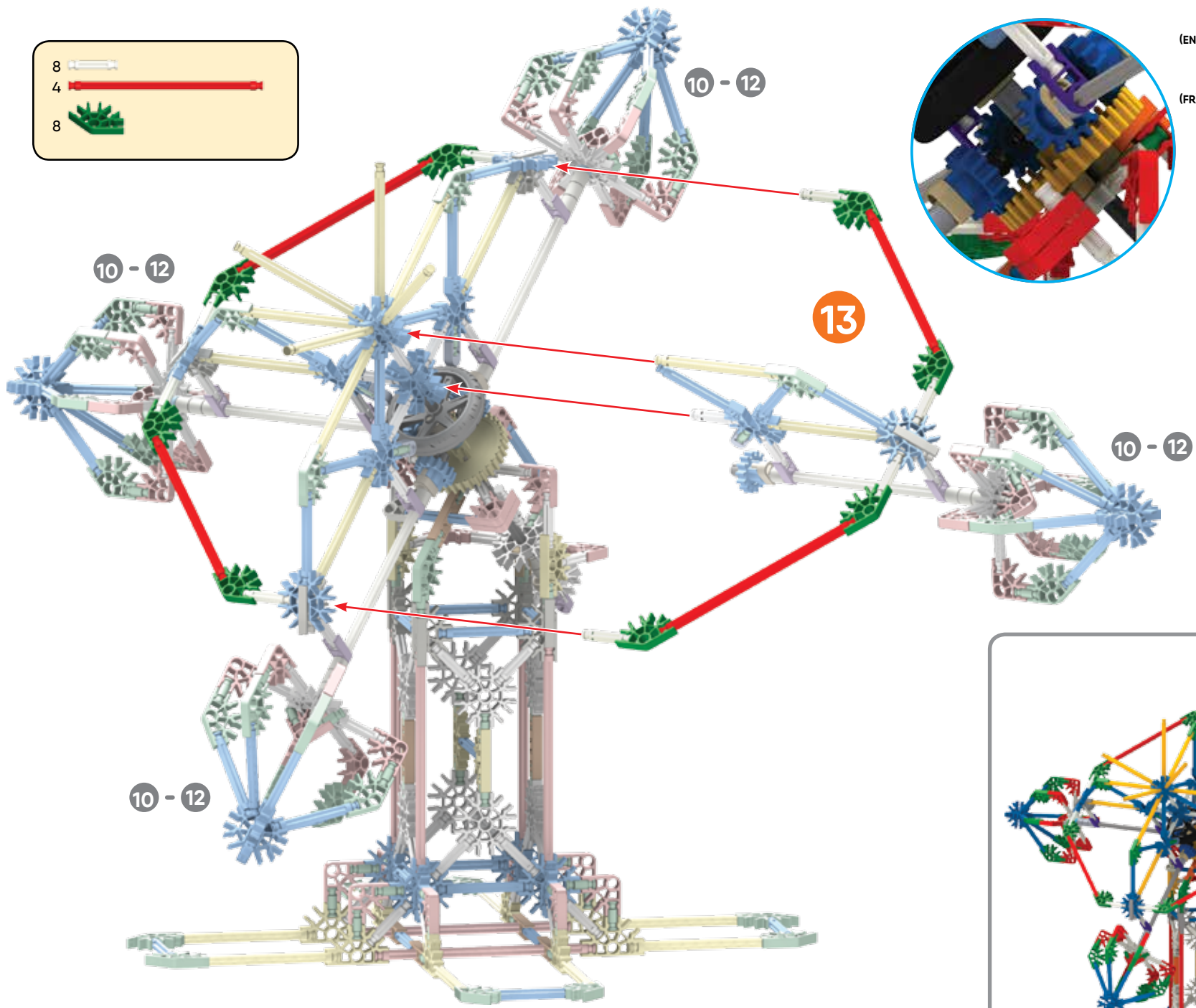
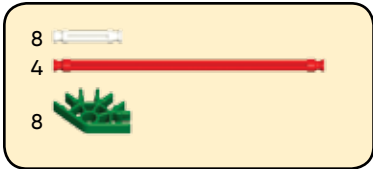

(EN) Make sure the gears mesh together.
(FR) Assurez-vous que des engrenages s'engrènent correctement.



Ambulance Ambulance

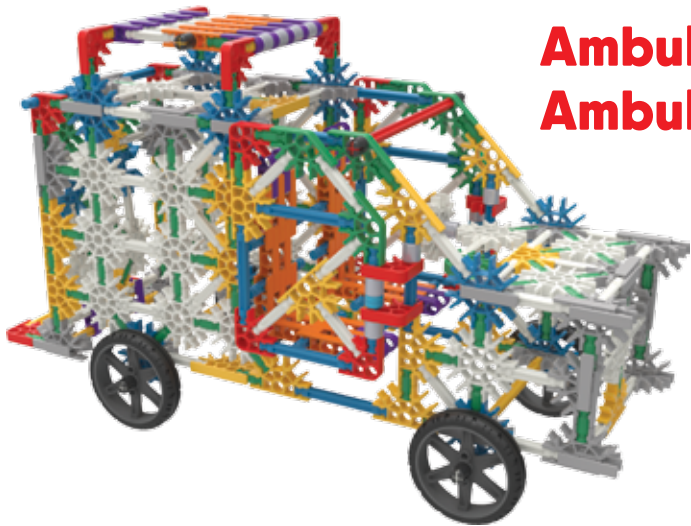

12		4			4	
6		2				
2		2				

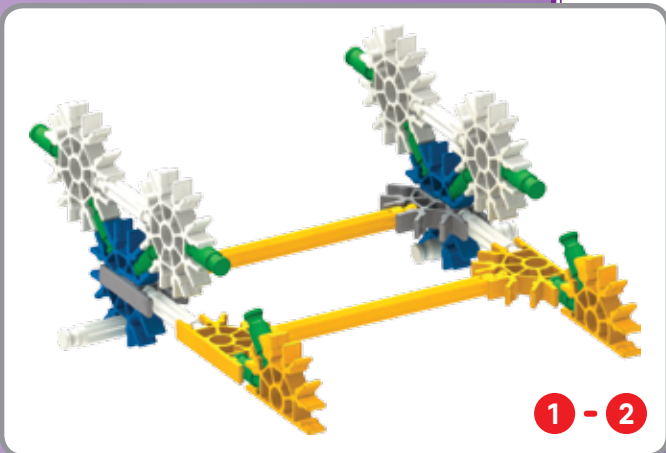
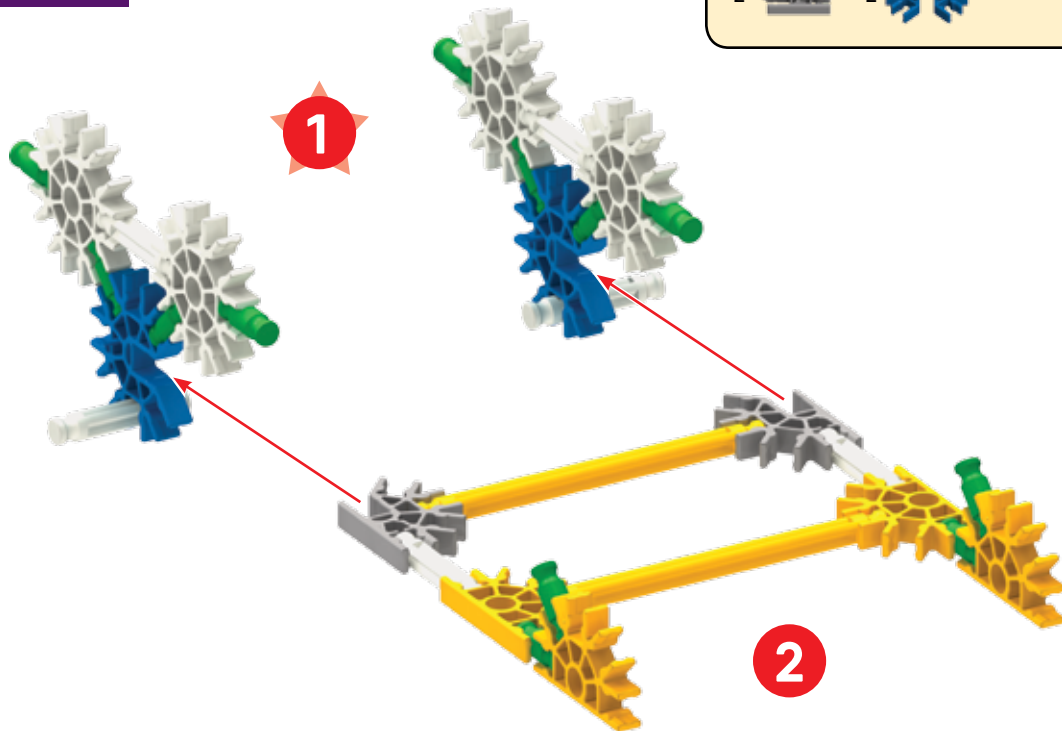

10		8	
1			
26		2	

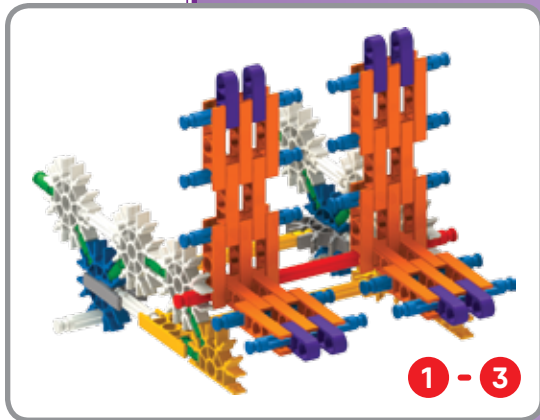
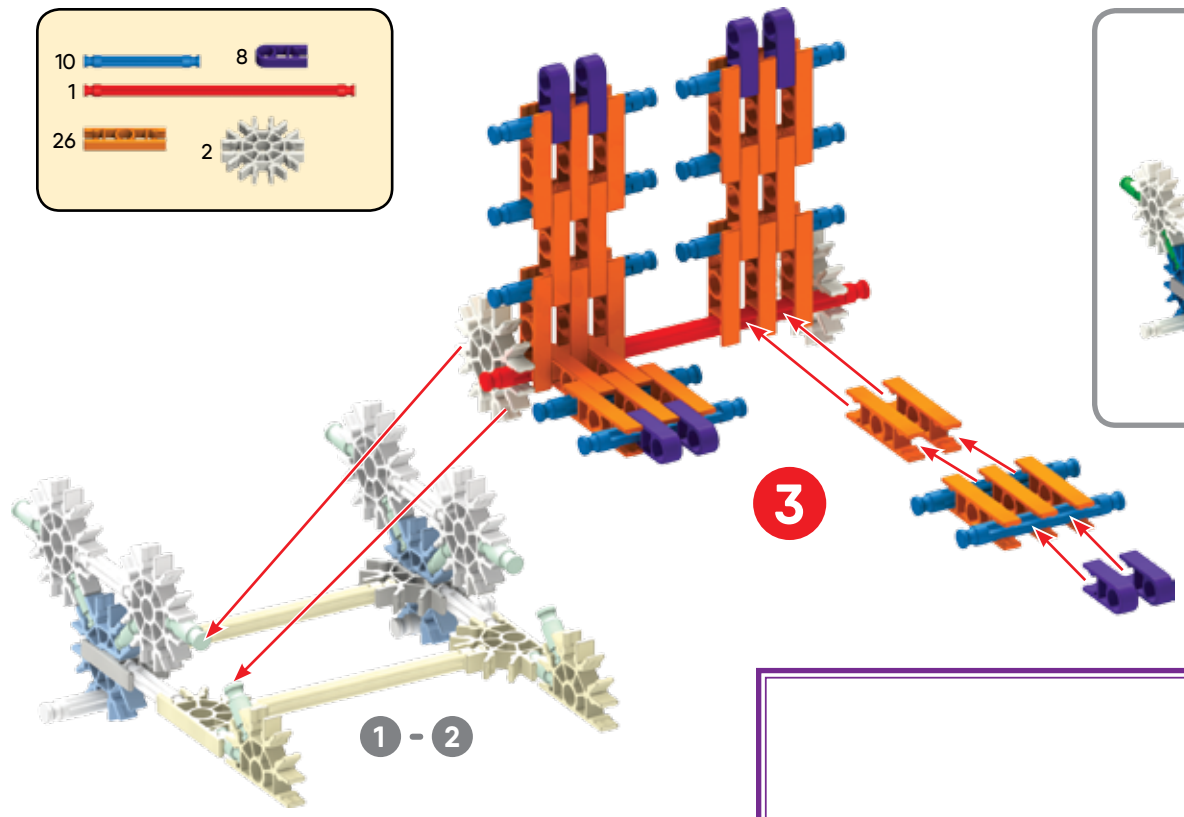

26		4		8	
10					

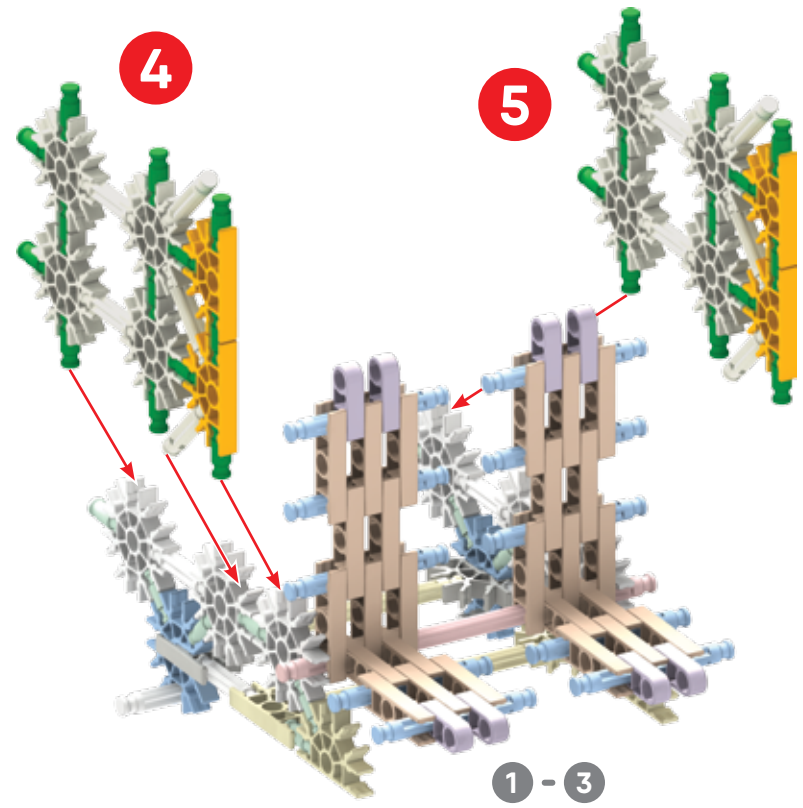

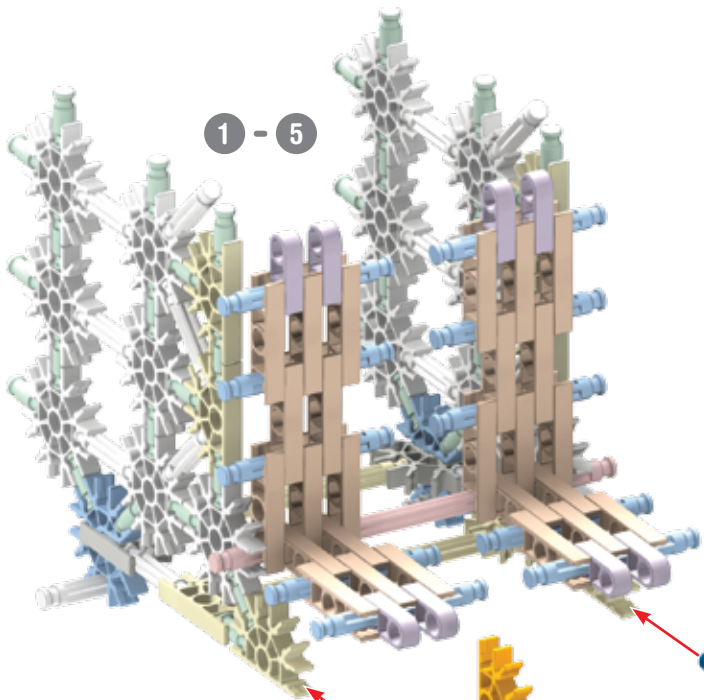

- | | | | |
|----|--|----|--|
| 16 | | 5 | |
| 12 | | 3 | |
| 2 | | 2 | |
| 1 | | 10 | |
| | | | |

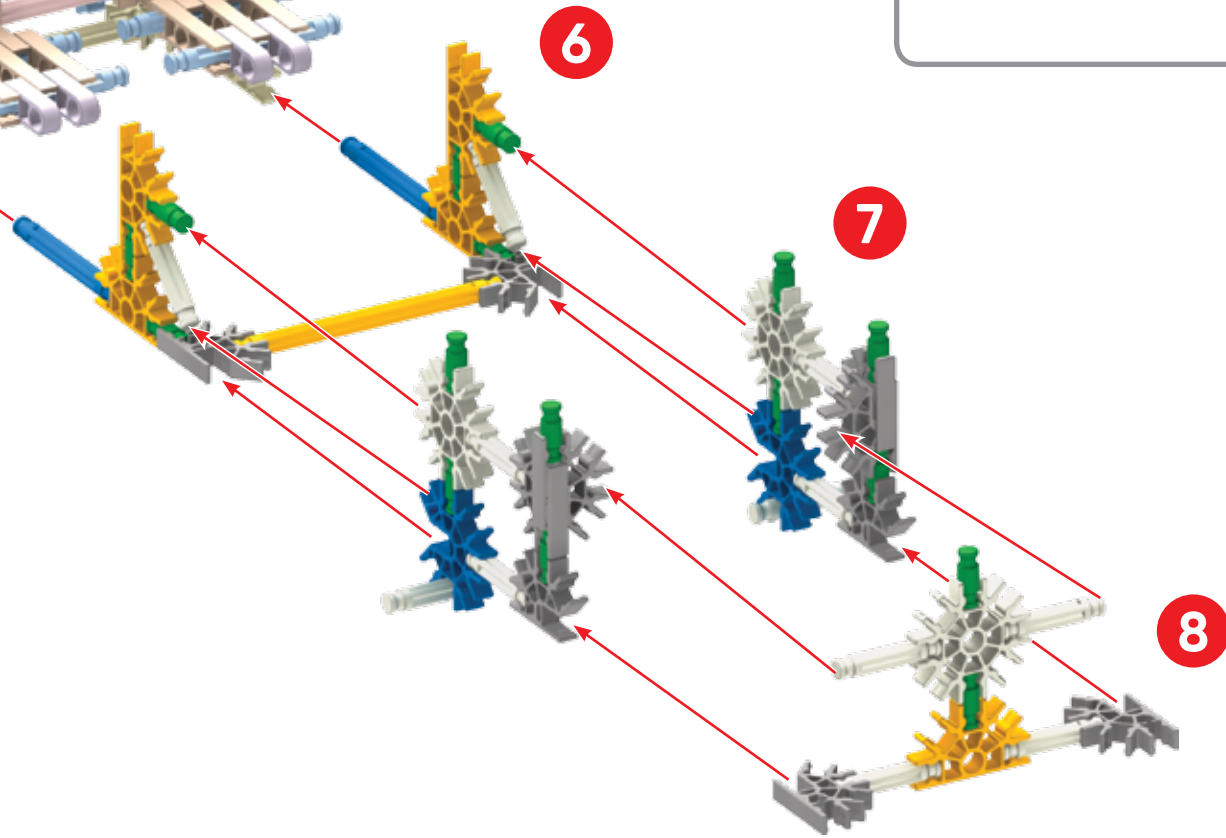
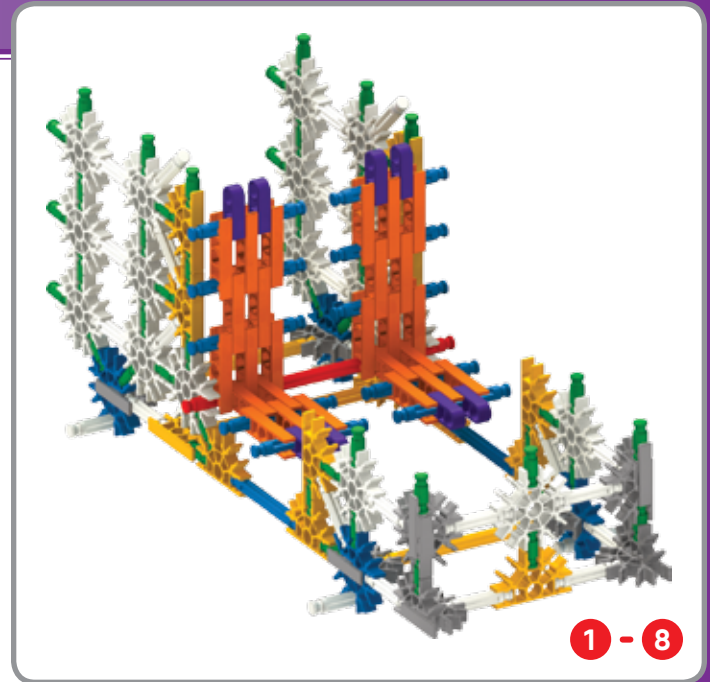

9

1	1	1	1
10	1	1	1
9	2	4	
8			

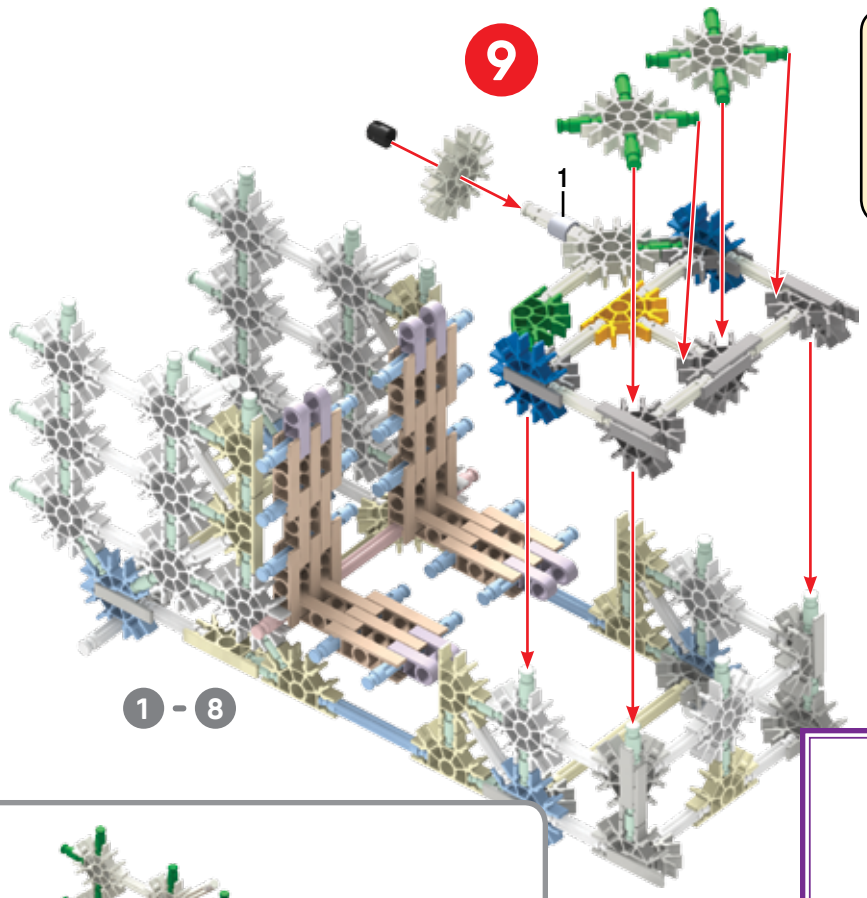

1 - 8

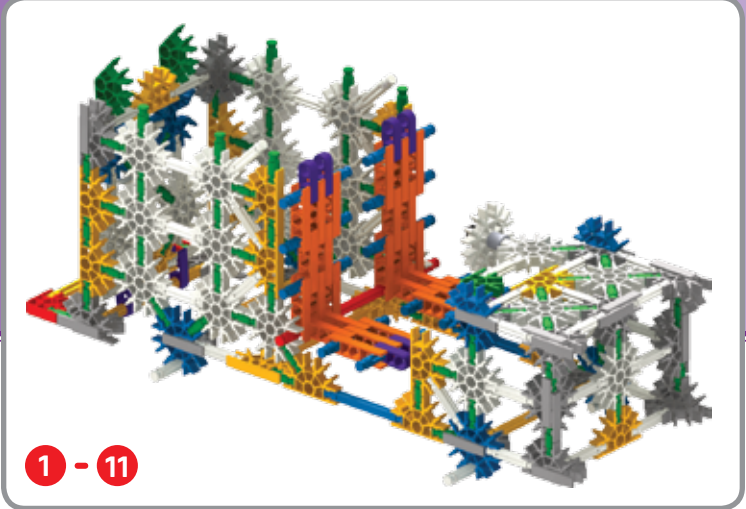

1 - 11

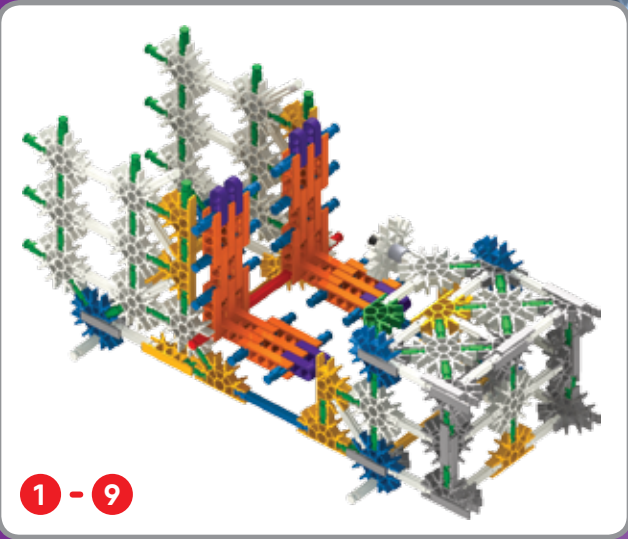

1 - 9

11



10

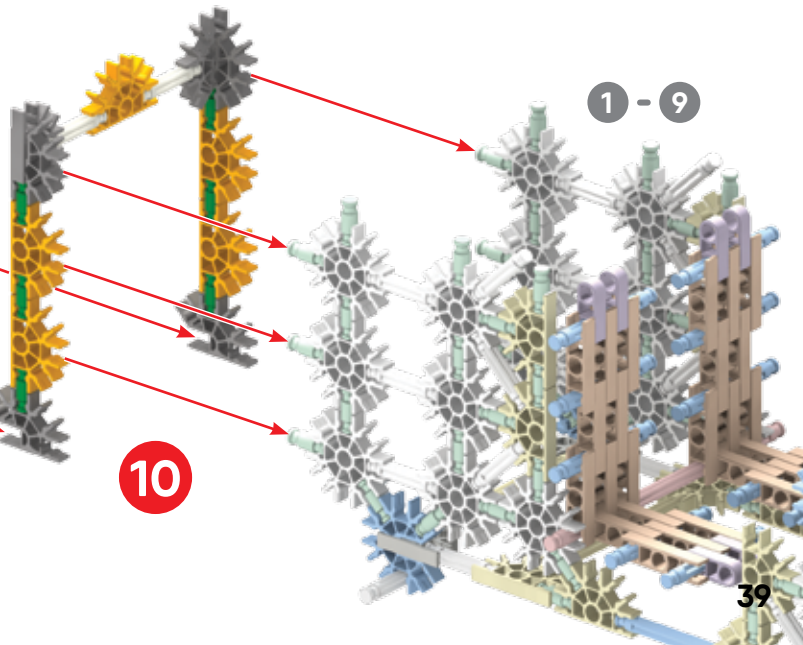

1 - 9

16	2	2	3
8	2	2	3
2	2	8	6
2	2	8	6

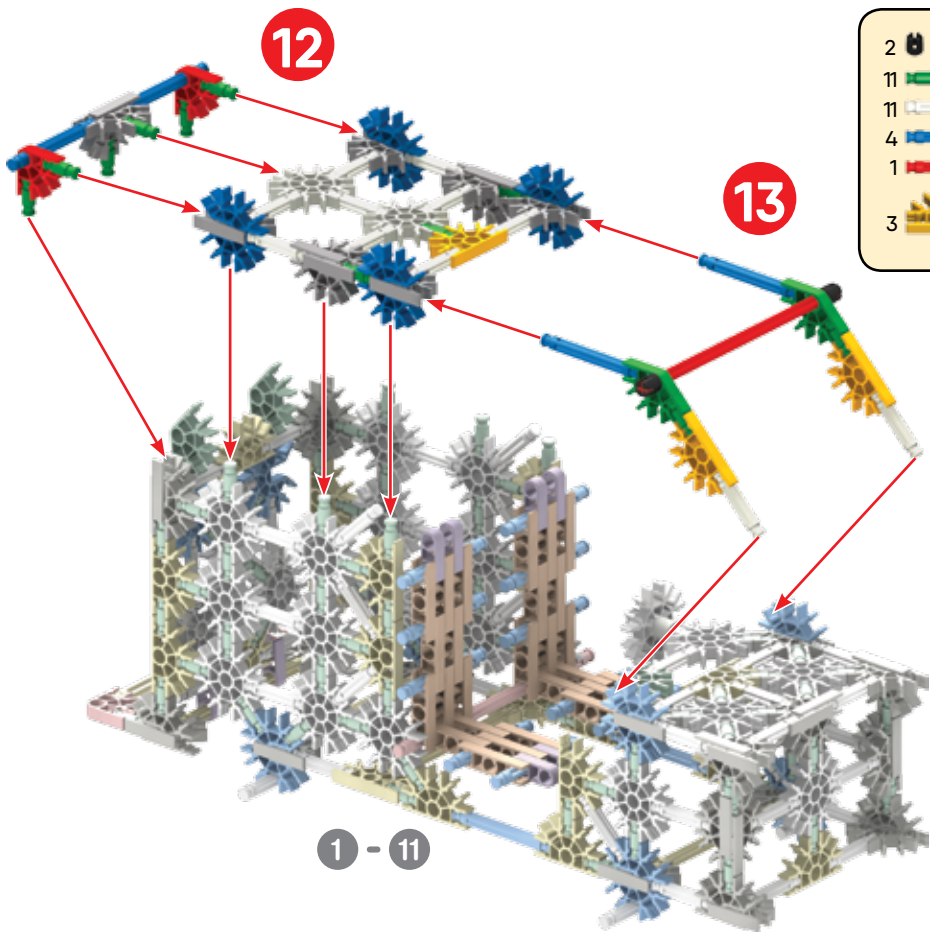

12

13

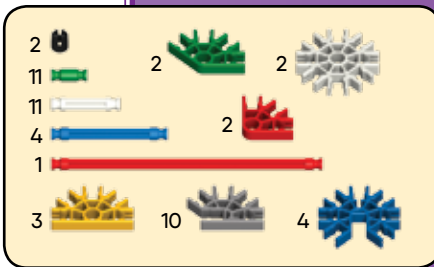

1 - 11

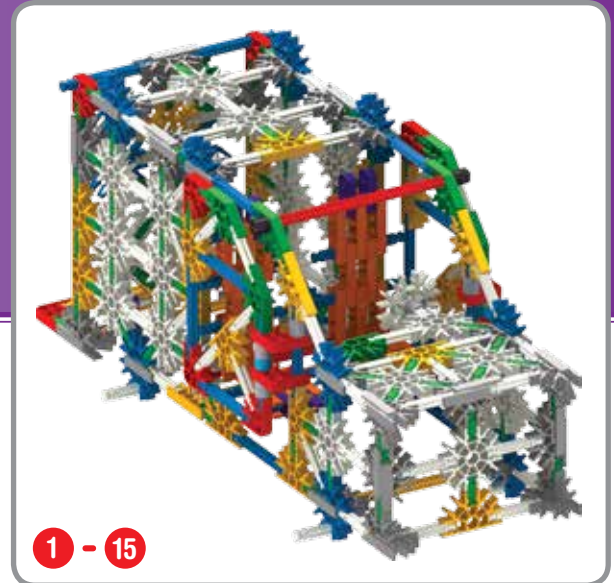

1 - 15

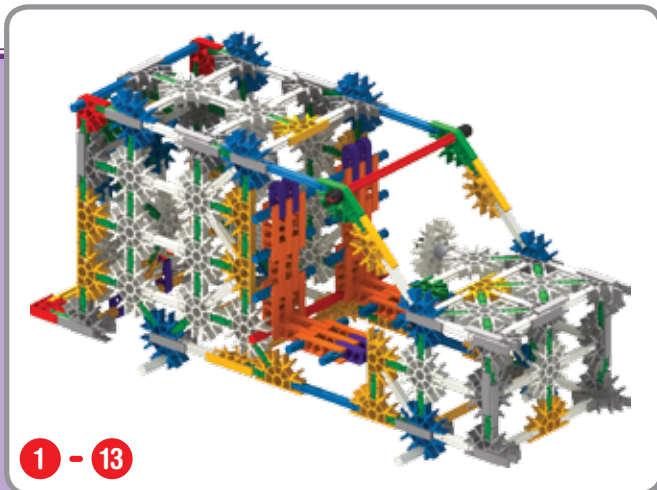
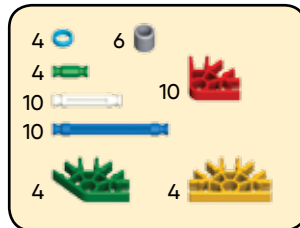

1 - 13

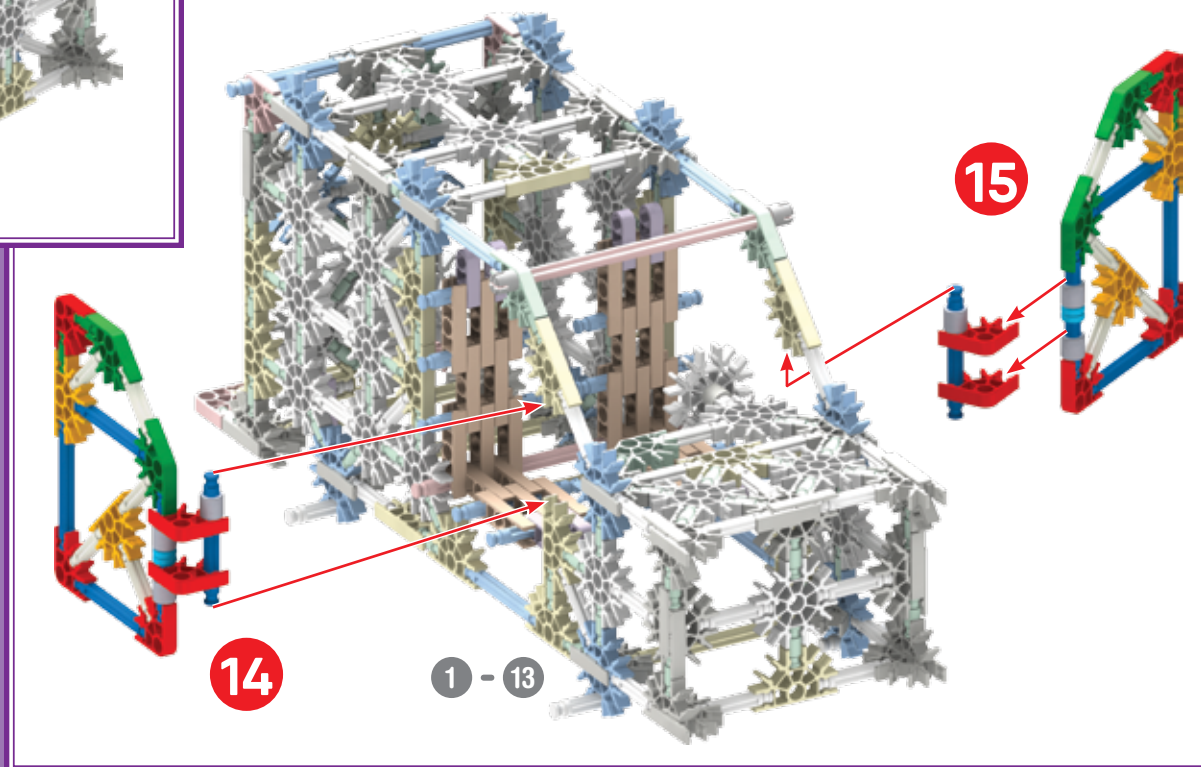

15

14

1 - 13

16

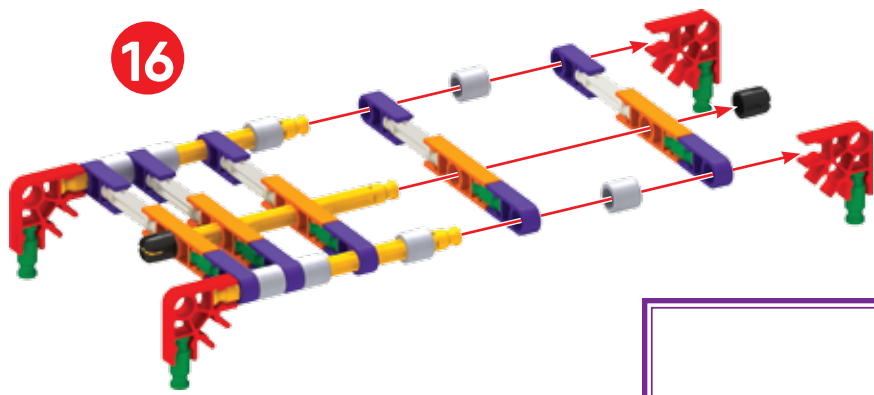

2	8	
9		4
5		
3		
10	5	

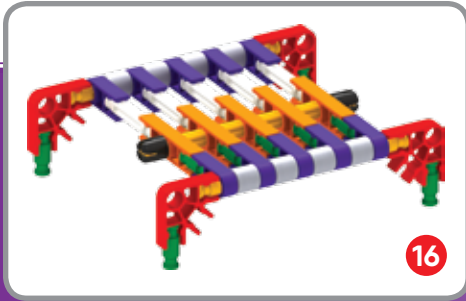

16



1 - 19

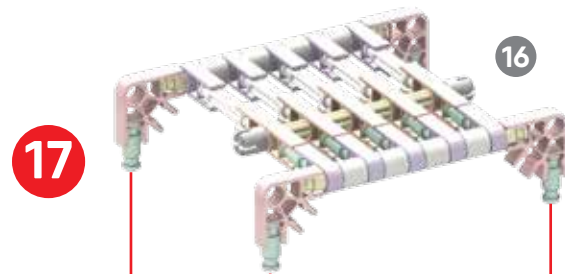

17

16

4	4
4	
4	

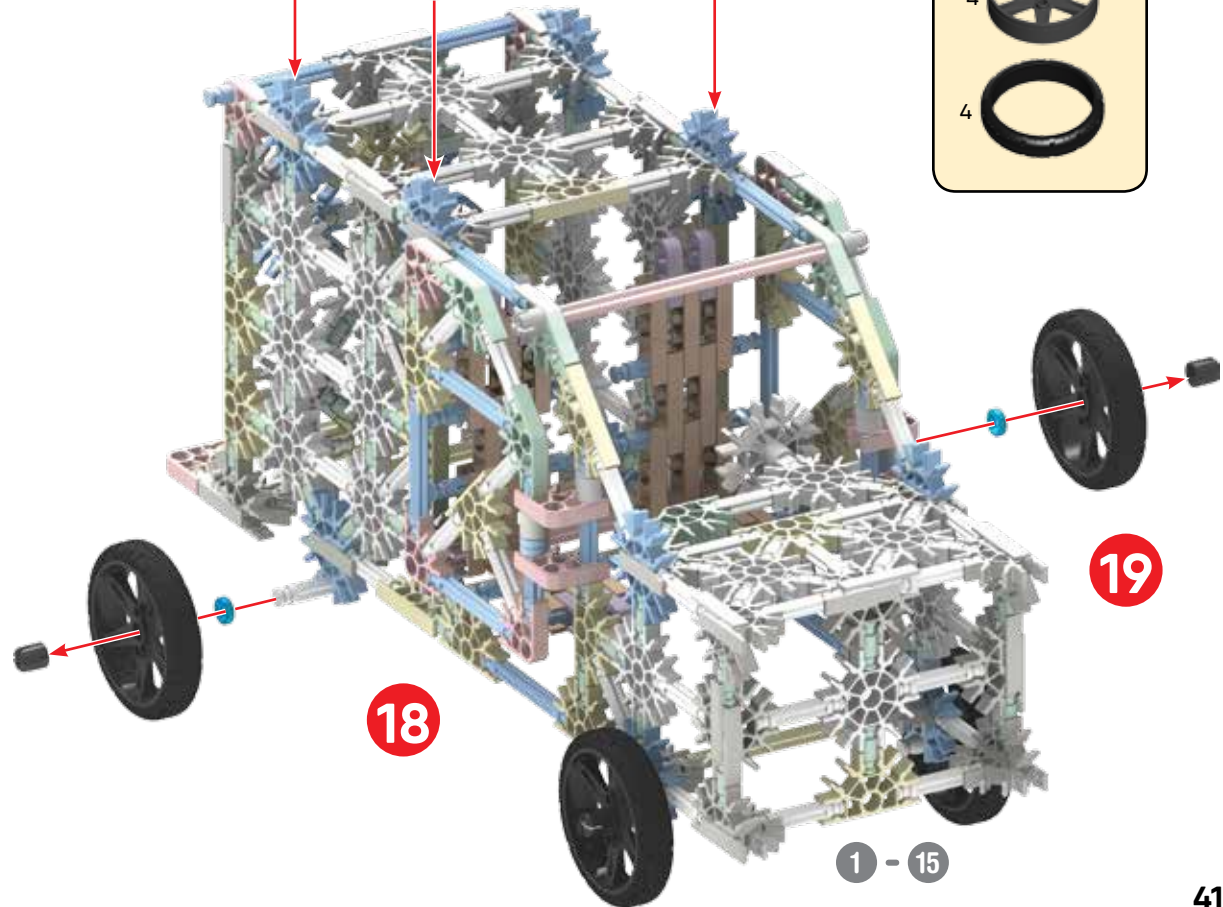

18

19

1 - 15

Large Helicopter Grand hélicoptère

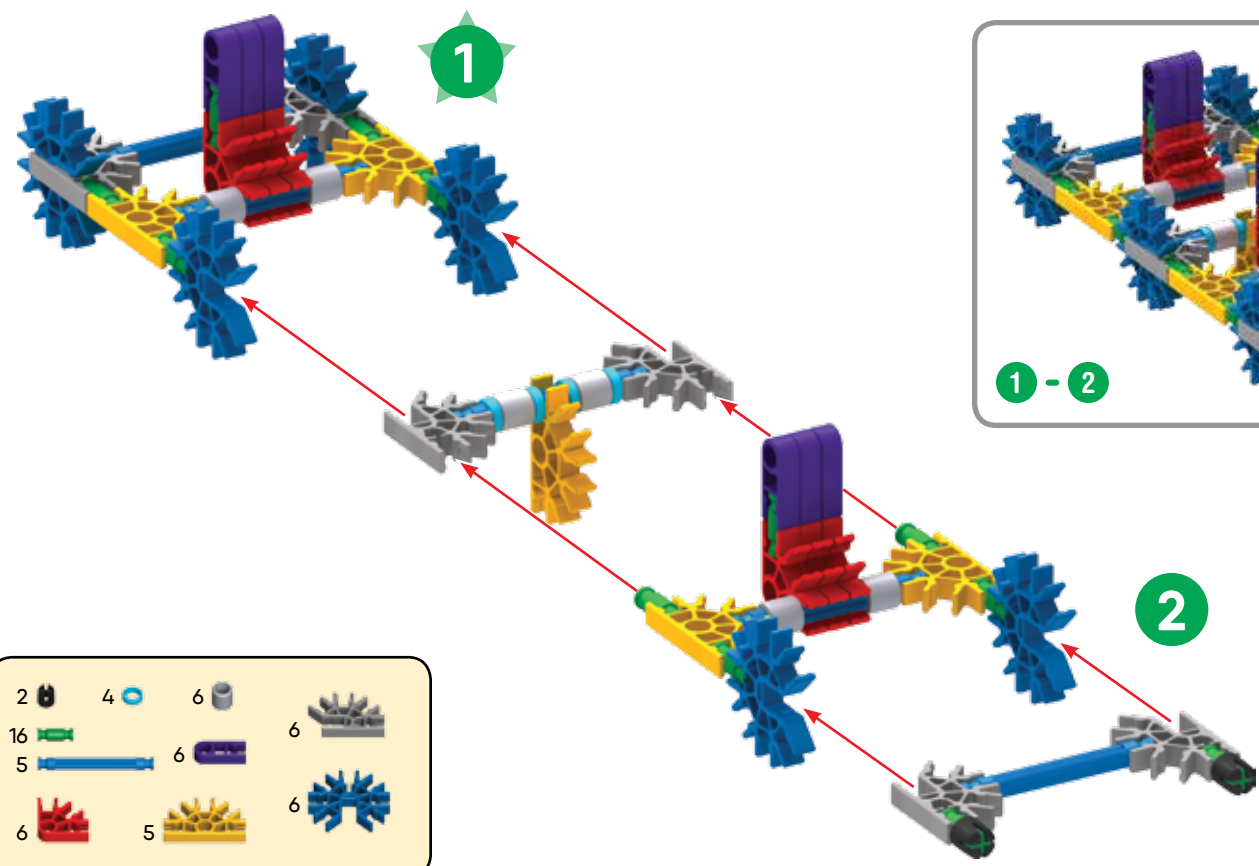

- | | | | | | | | |
|----|--|---|--|---|--|---|--|
| 2 | | 4 | | 6 | | | |
| 16 | | | | 6 | | 6 | |
| 5 | | | | 6 | | 6 | |
| 6 | | 5 | | | | 6 | |

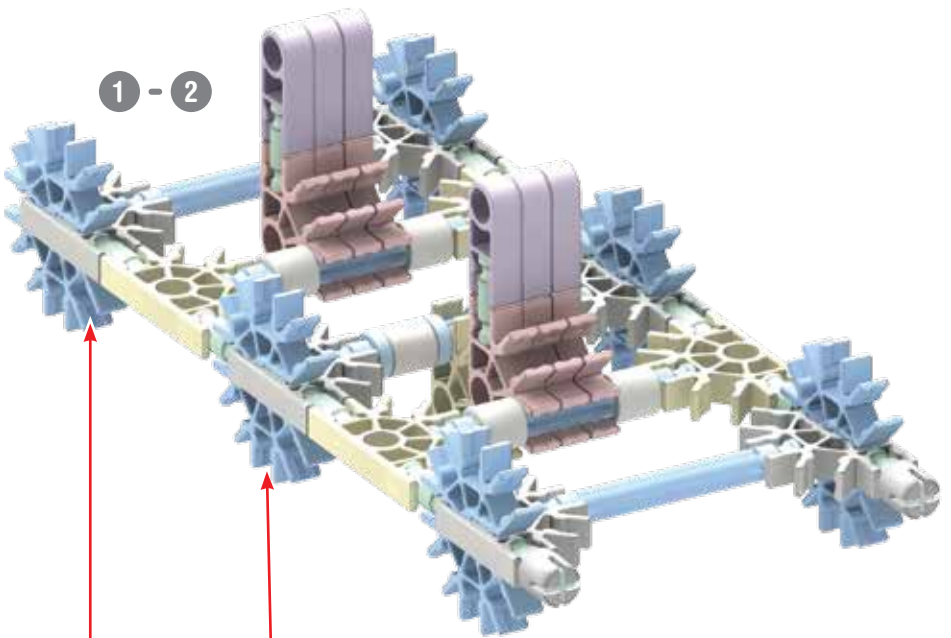

- | | | | |
|----|--|---|--|
| 4 | | 8 | |
| 12 | | | |
| 4 | | | |
| 1 | | | |
| 2 | | 2 | |

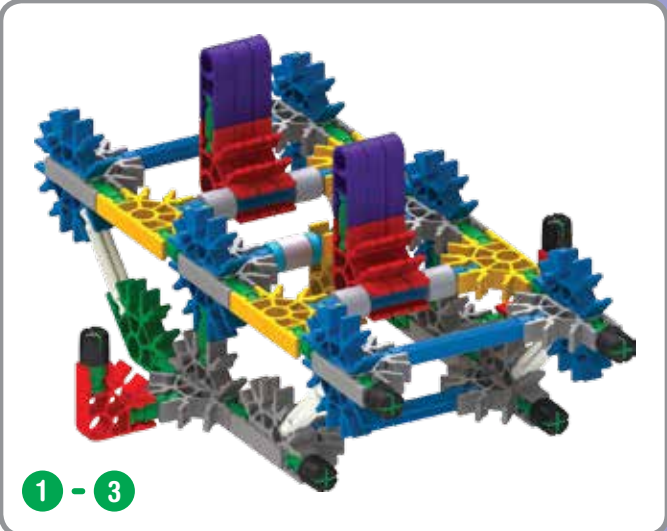
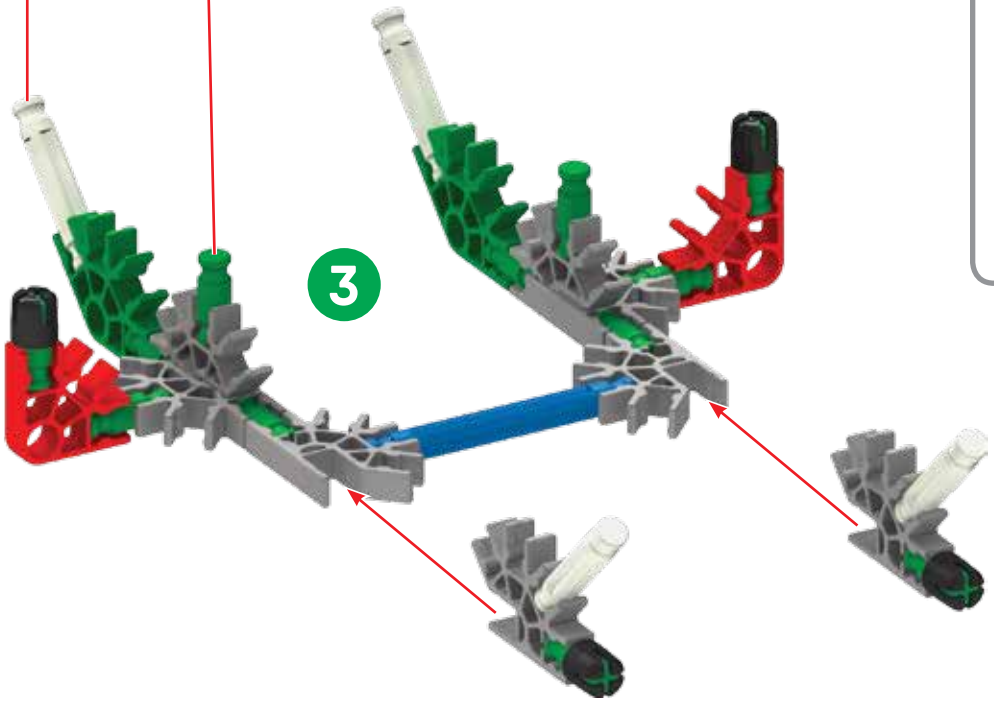

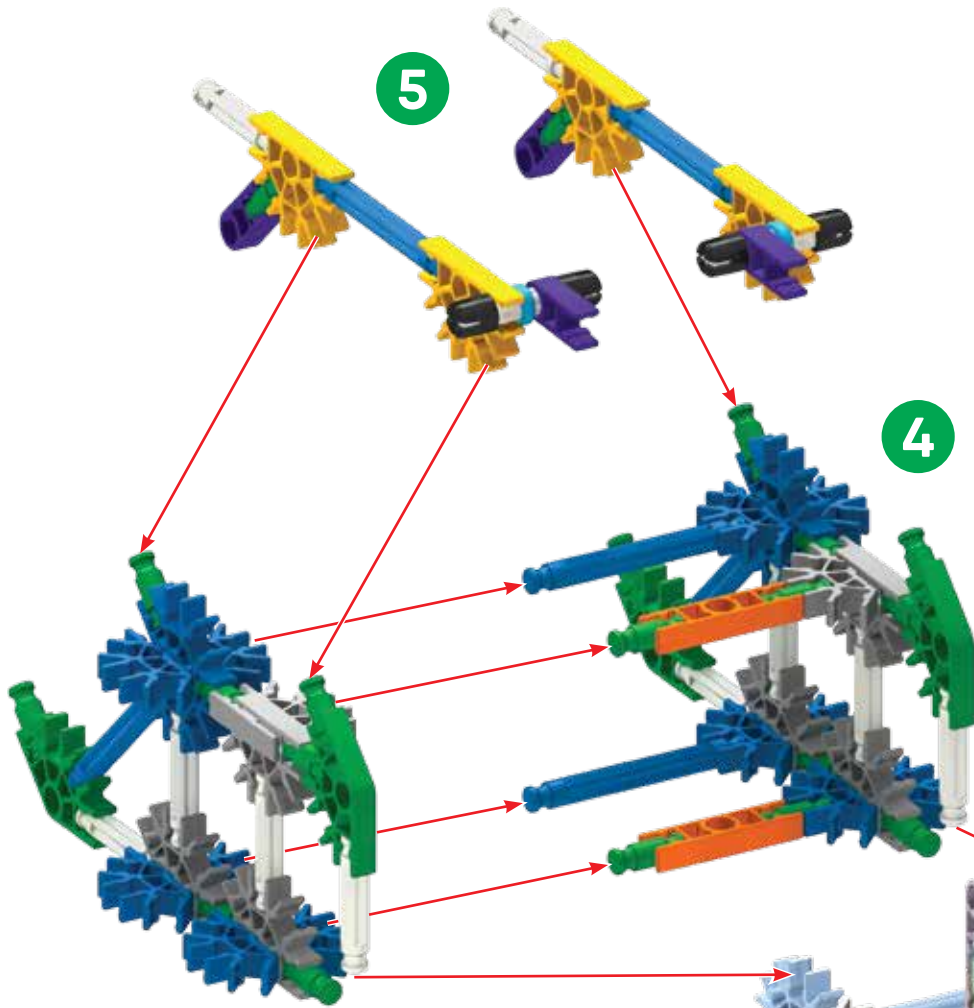

- | | | | | | | | |
|----|--|---|--|---|--|---|--|
| 20 | | 2 | | 4 | | 2 | |
| 12 | | | | 4 | | 4 | |
| 6 | | | | | | | |
| 4 | | 8 | | 8 | | | |

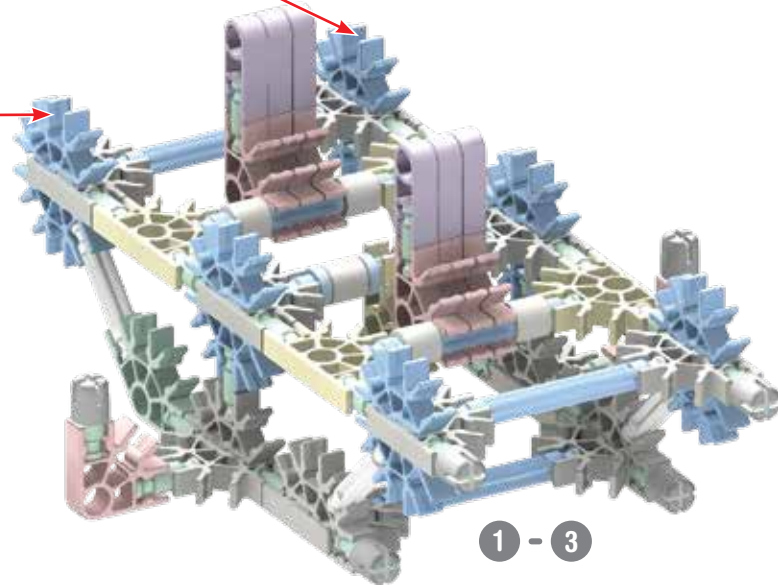

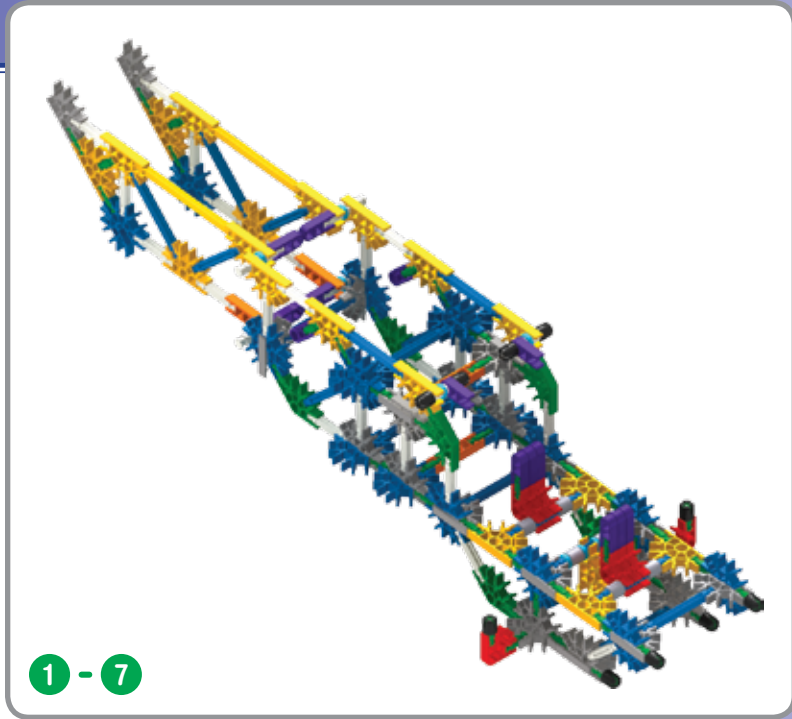
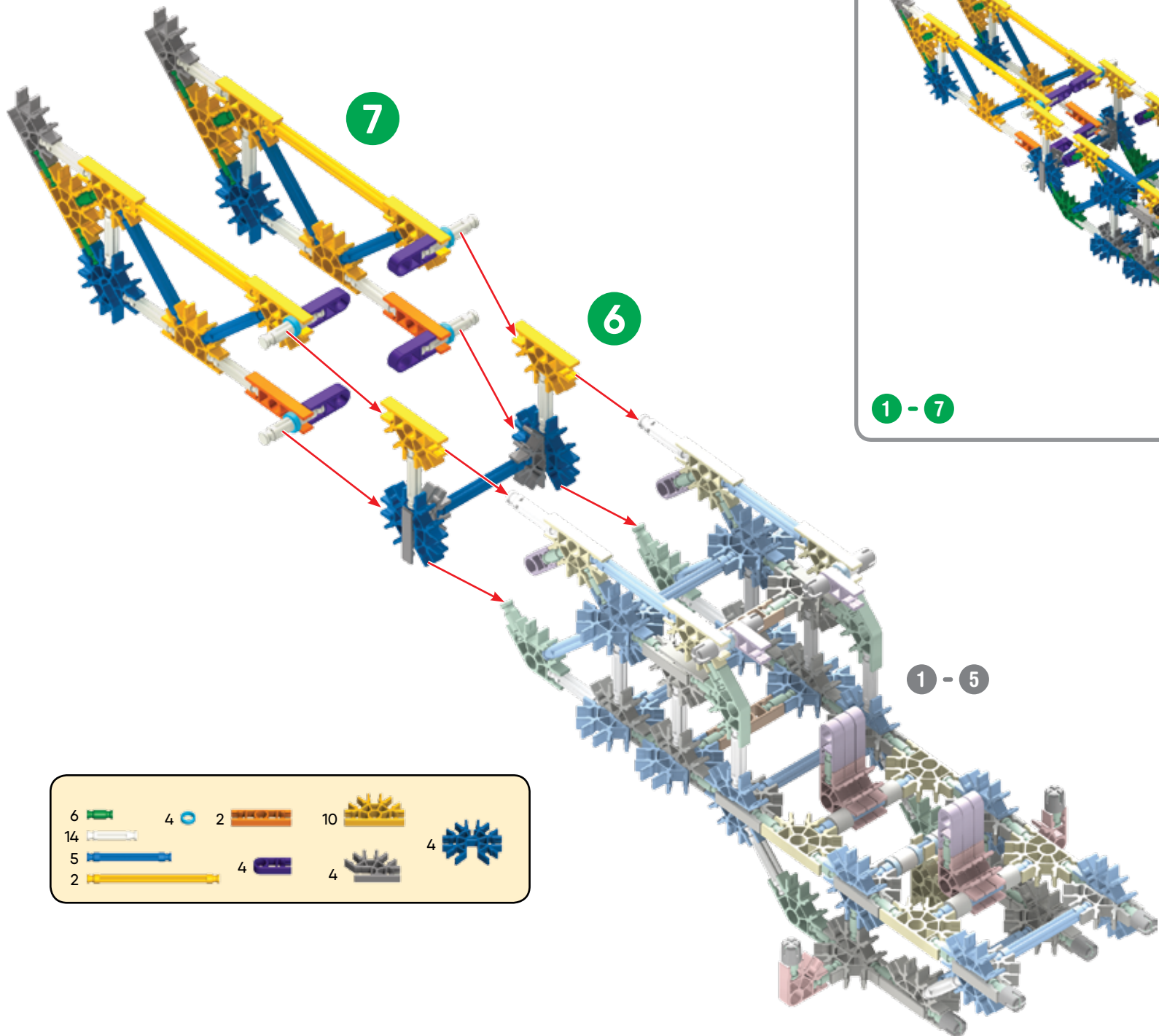

- | | | | | | | | |
|----|--|---|--|---|--|----|--|
| 6 | | 4 | | 2 | | 10 | |
| 14 | | | | | | | |
| 5 | | 4 | | 4 | | | |
| 2 | | | | | | | |

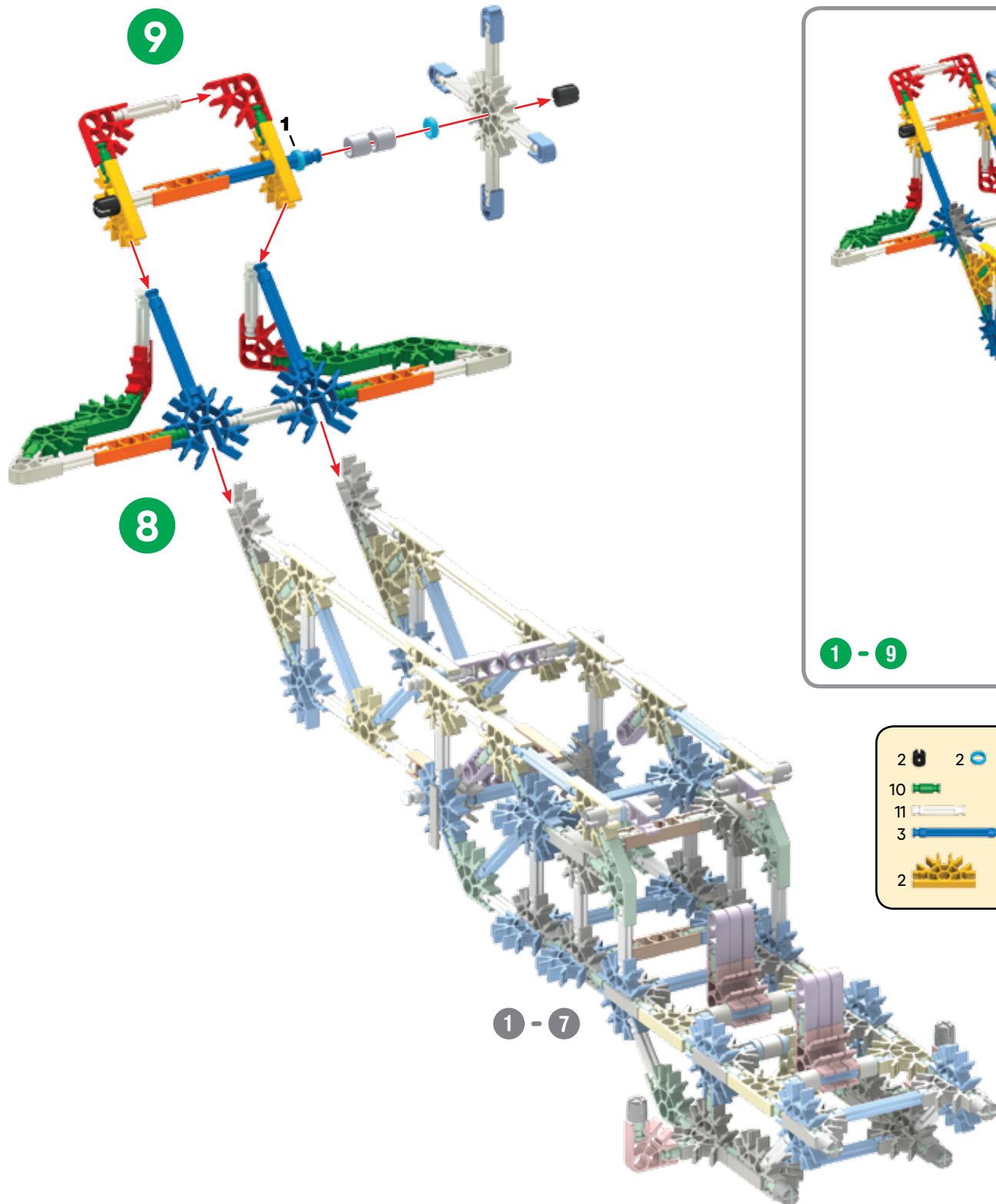

- | | | | | |
|----|---|---|---|---|
| 2 | 2 | 2 | 2 | 3 |
| 10 | 4 | 4 | 4 | |
| 11 | | | | |
| 3 | 2 | 1 | | |
| 2 | | | | |

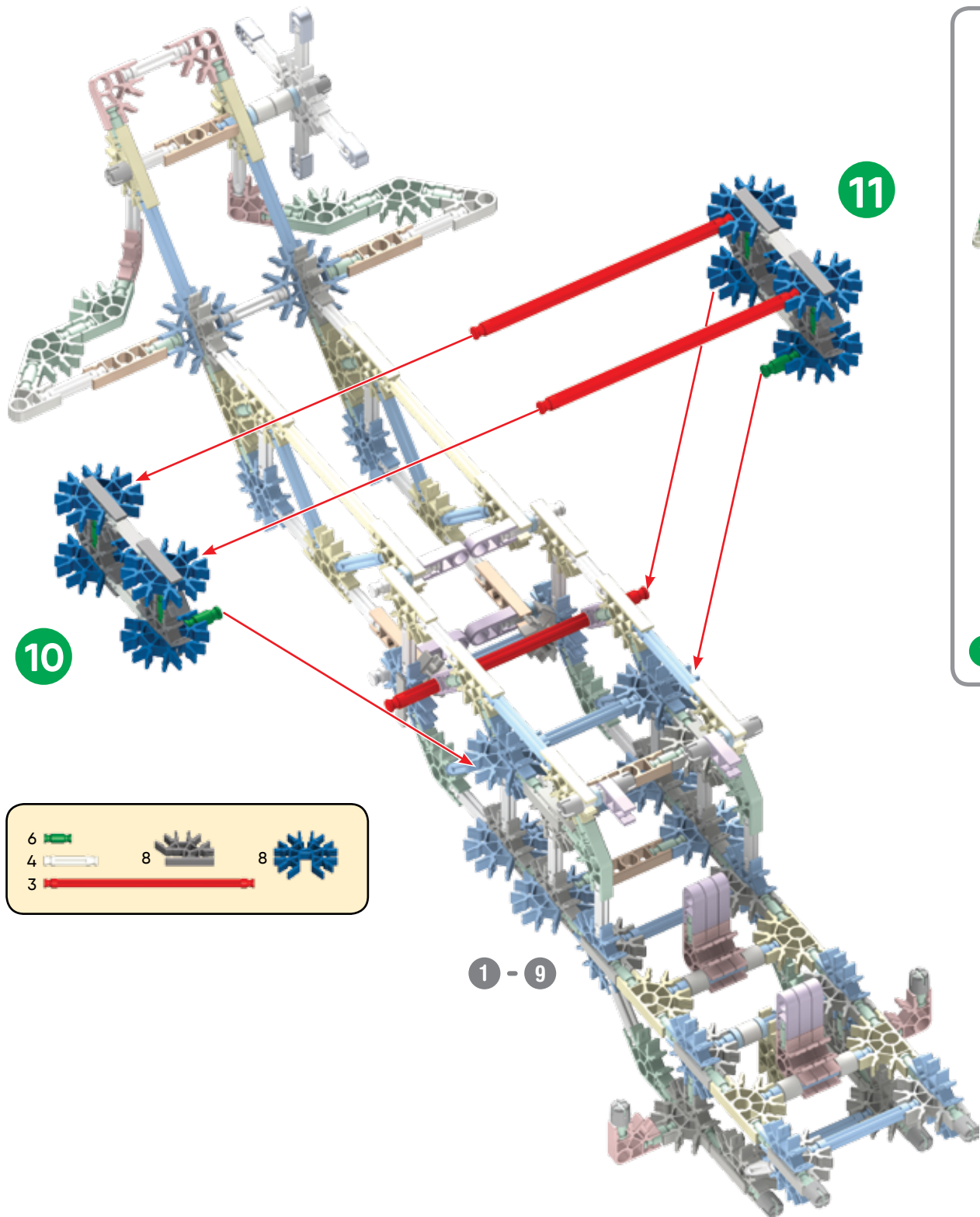

- | | | | | | |
|---|--|---|--|---|--|
| 6 | | 8 | | 8 | |
| 4 | | | | | |
| 3 | | | | | |

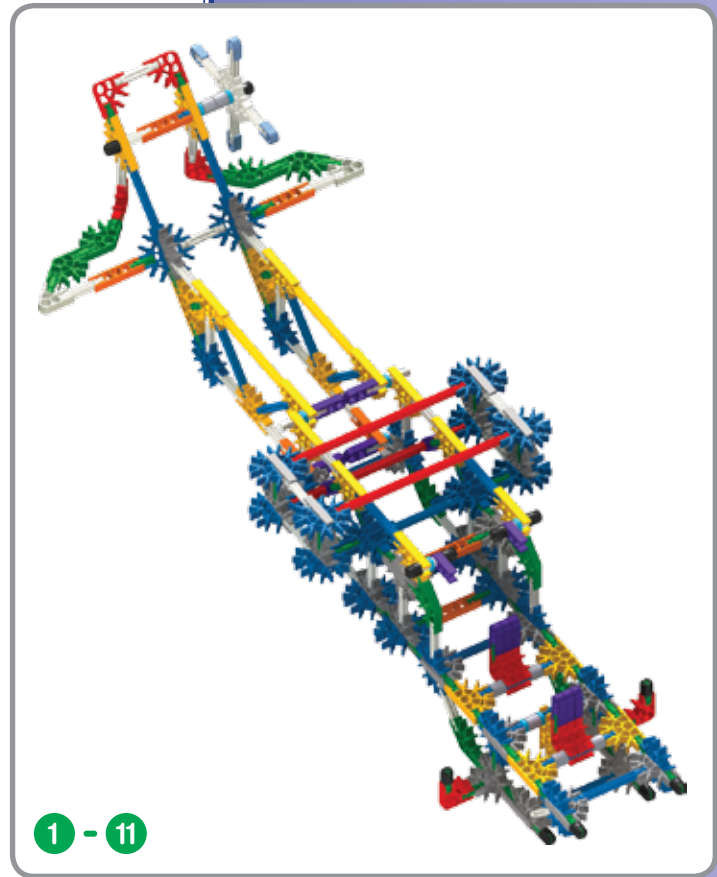

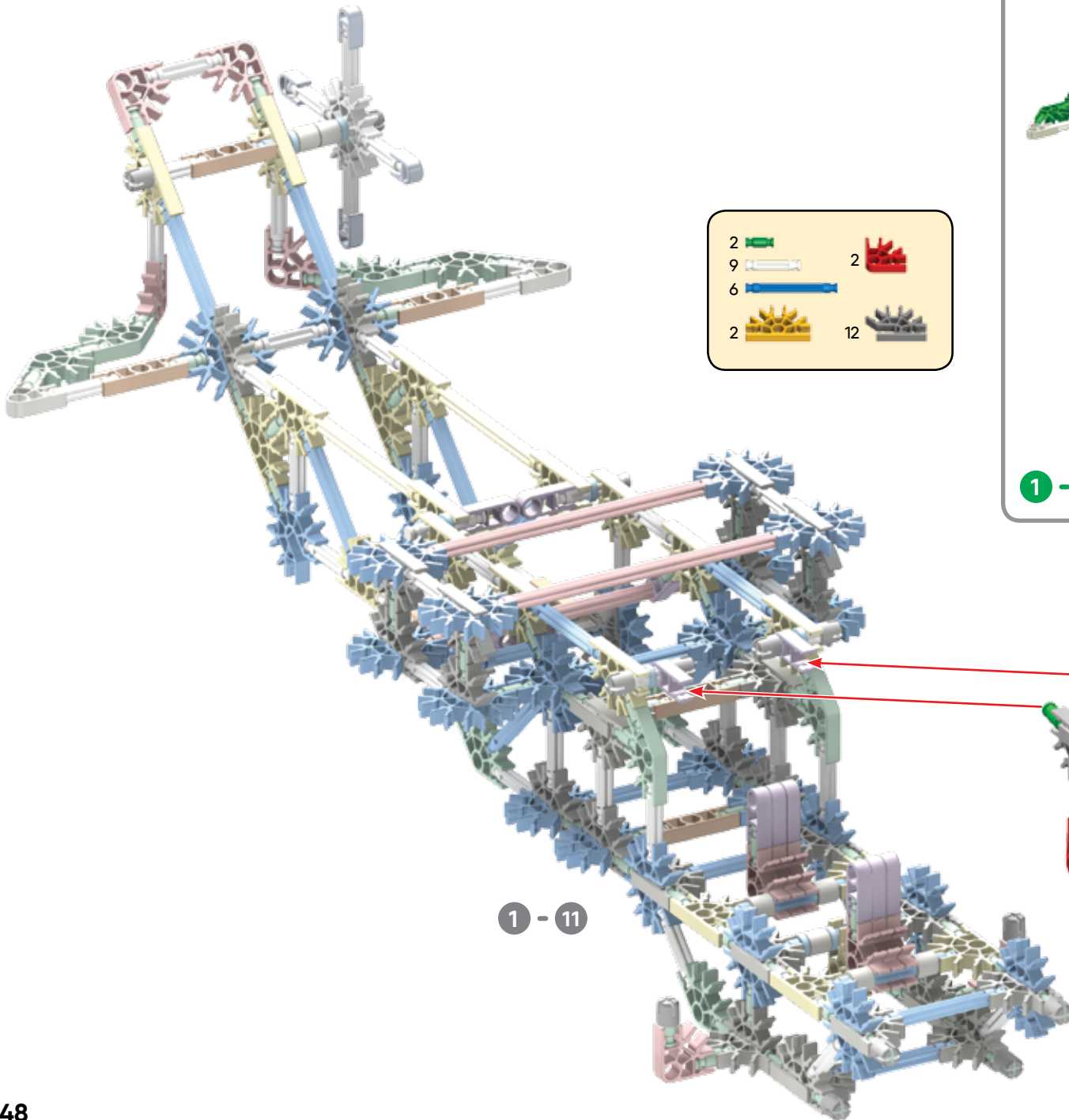

- | | | | |
|---|--|----|--|
| 2 | | 2 | |
| 9 | | | |
| 6 | | | |
| 2 | | 12 | |

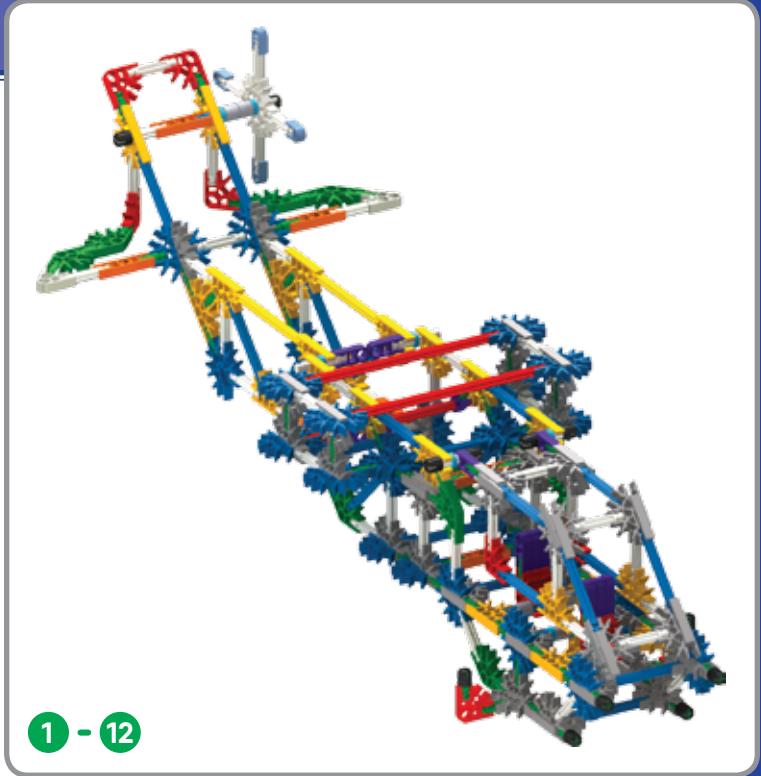

12

1 - 11

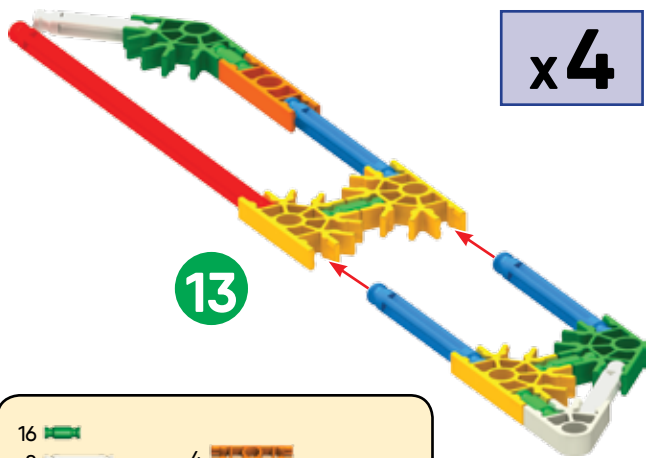

x4

13

- 16
- 8
- 12
- 4
- 4
- 8
- 12
- 4

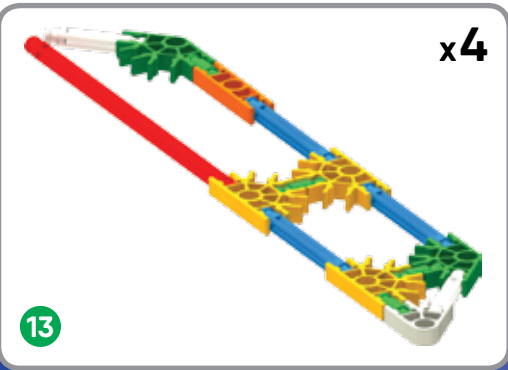

x4

13

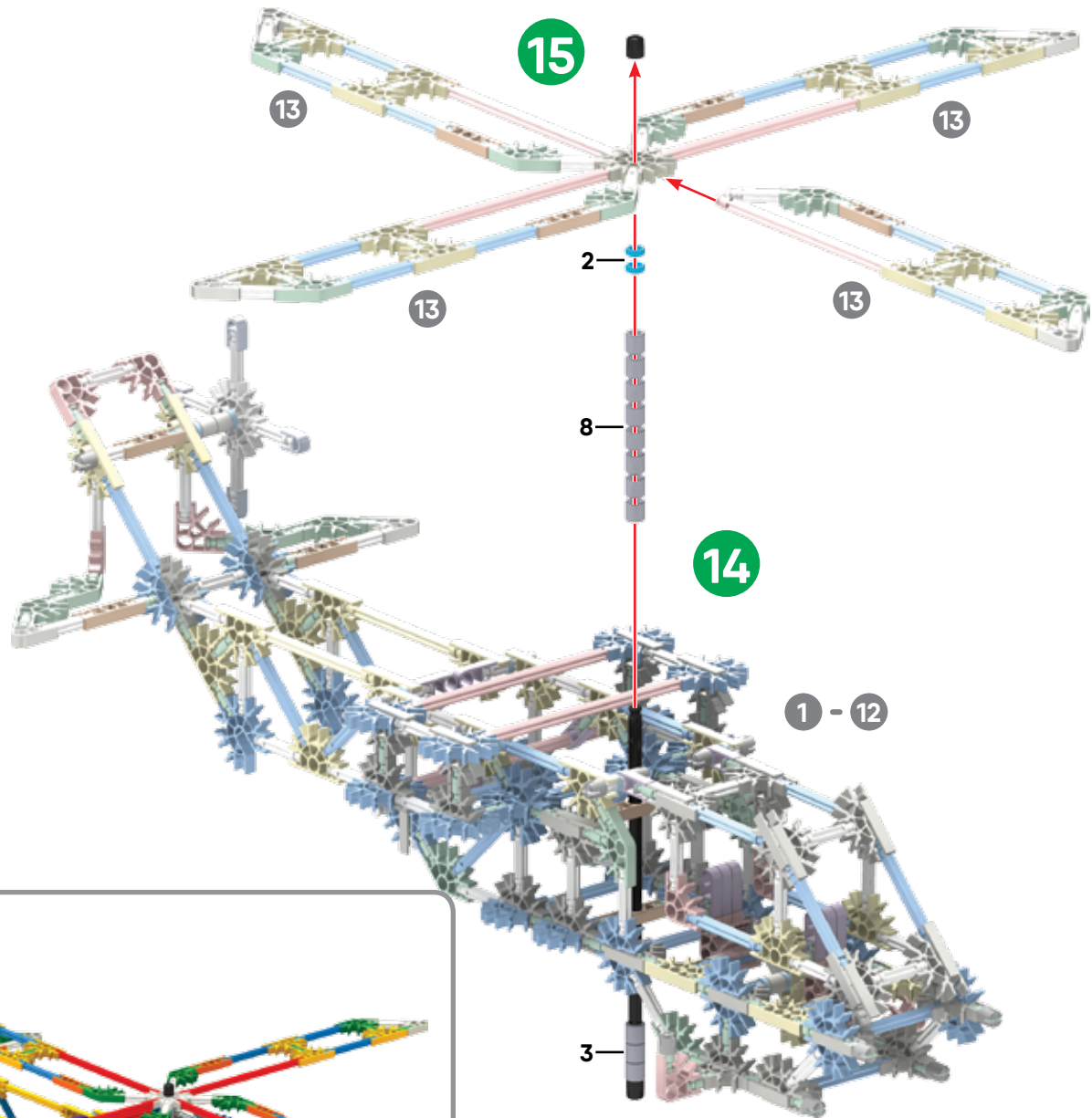

15

13

13

13

13

2

8

14

1 - 12

3

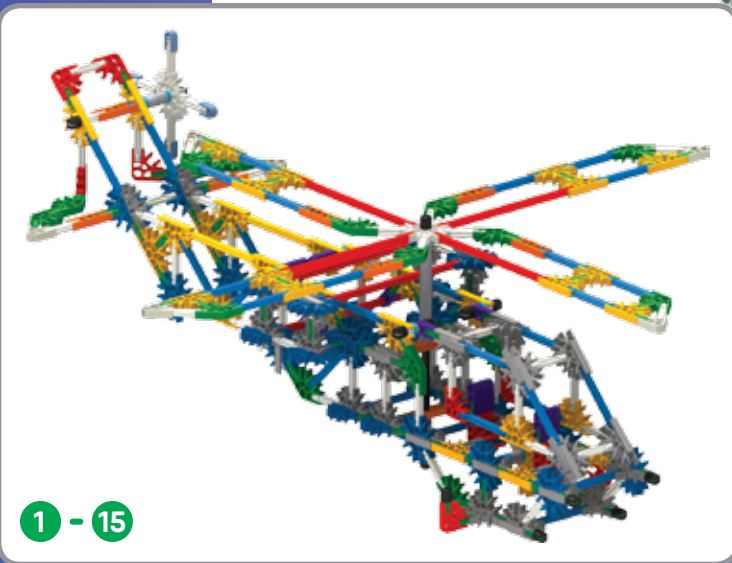

1 - 15

- 2
- 2
- 11
- 1
- 1

16

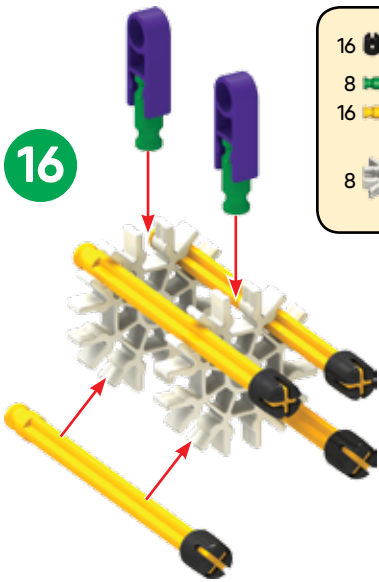

- 16
- 8
- 16
- 8

x4

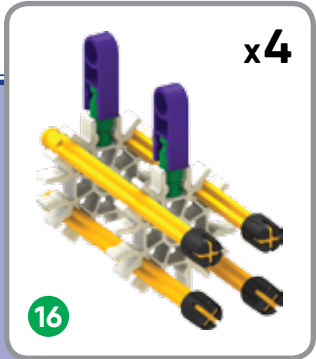

x4

16

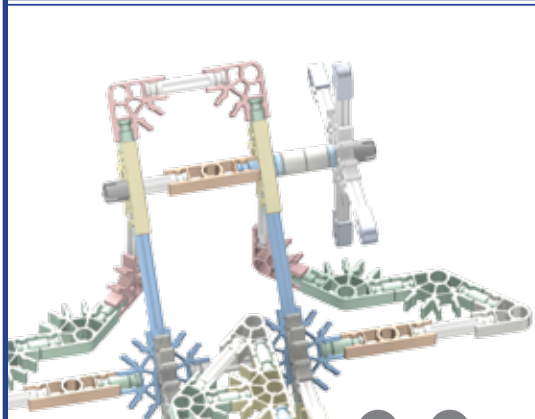

1 - 15

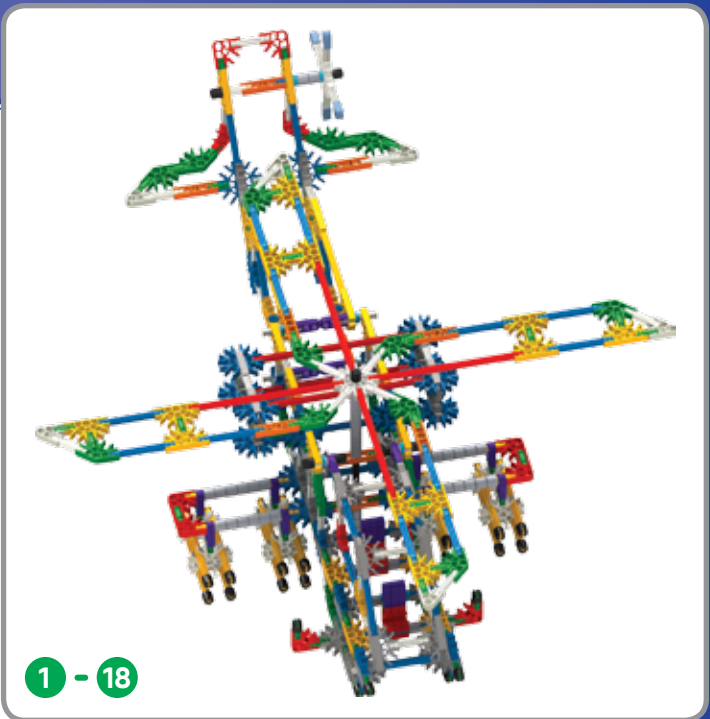

1 - 18

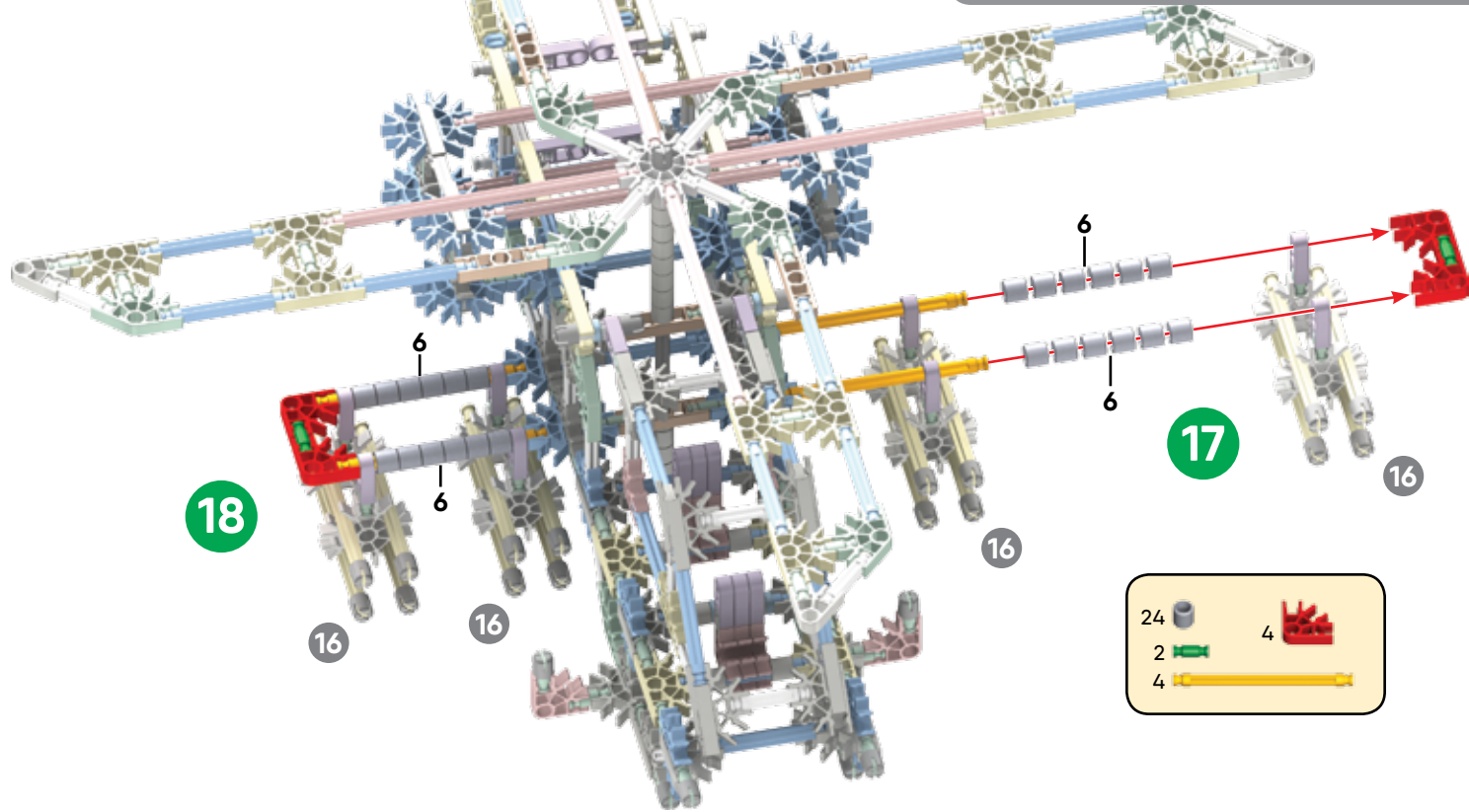

18

16

16

16

17

16

- 24
- 2
- 4
- 4

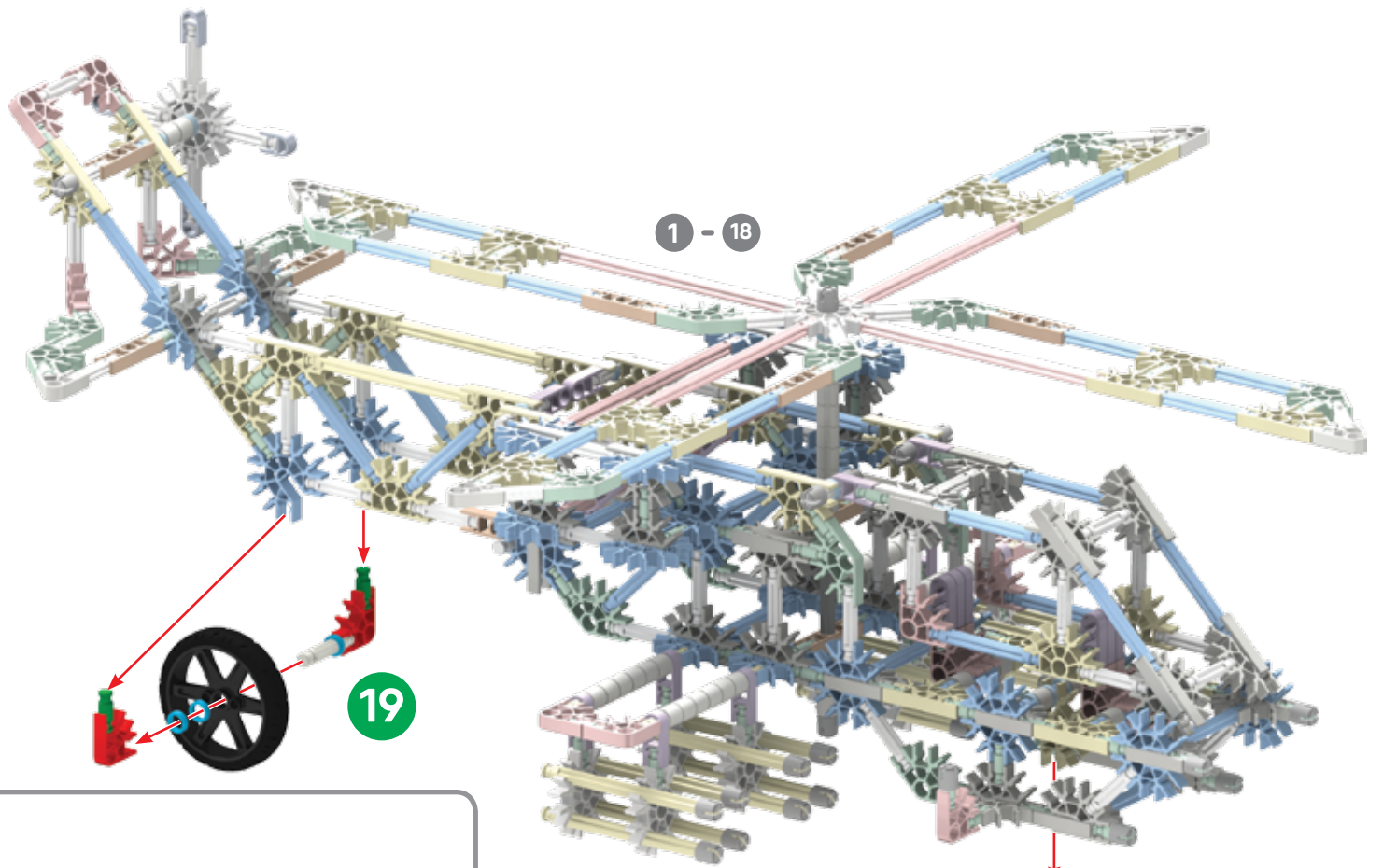

1 - 18

- 2
- 3
- 2
- 4
- 4
- 1
- 2
- 2
- 3
- 3

19

20



1 - 20



Blimp Dirigeable

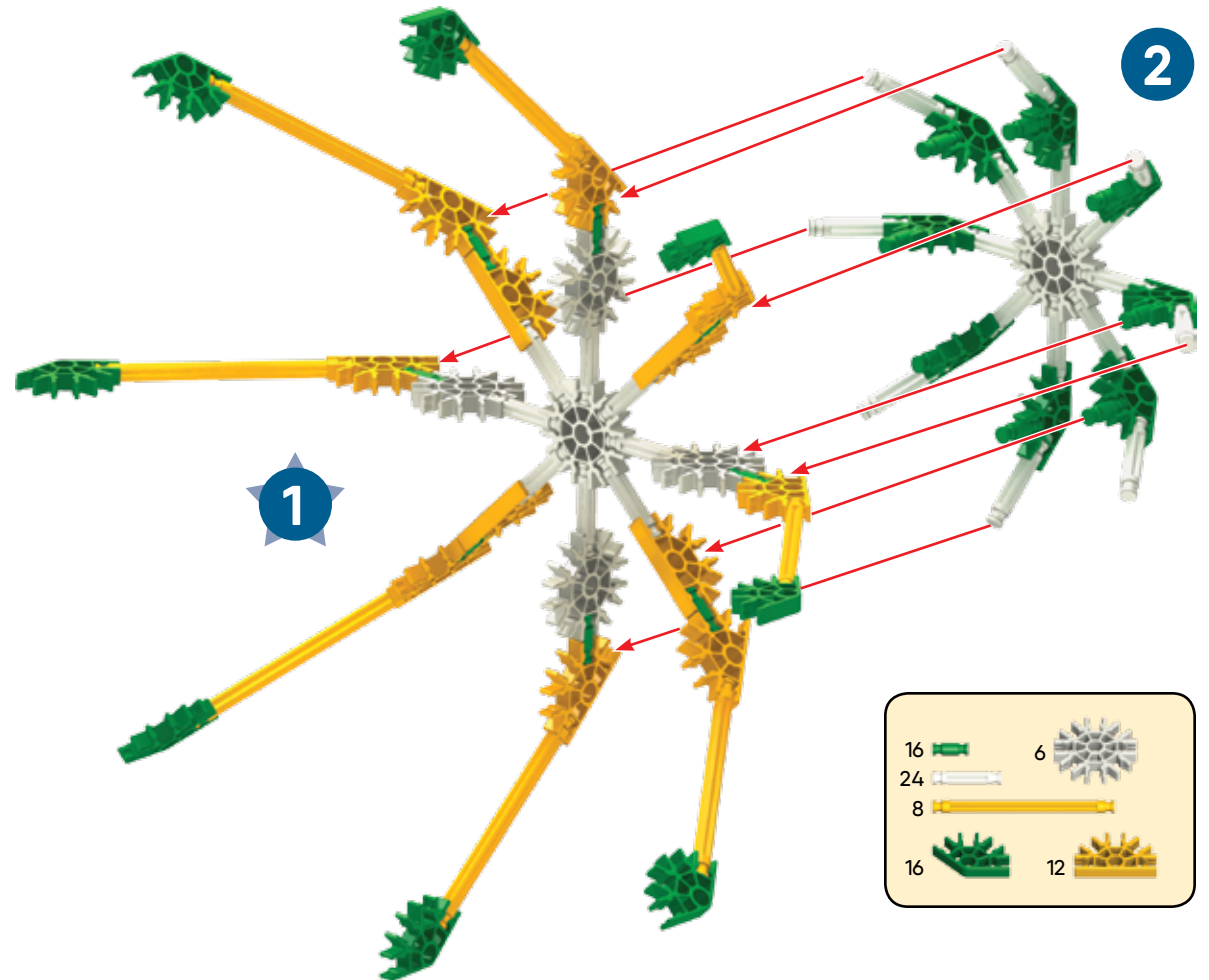
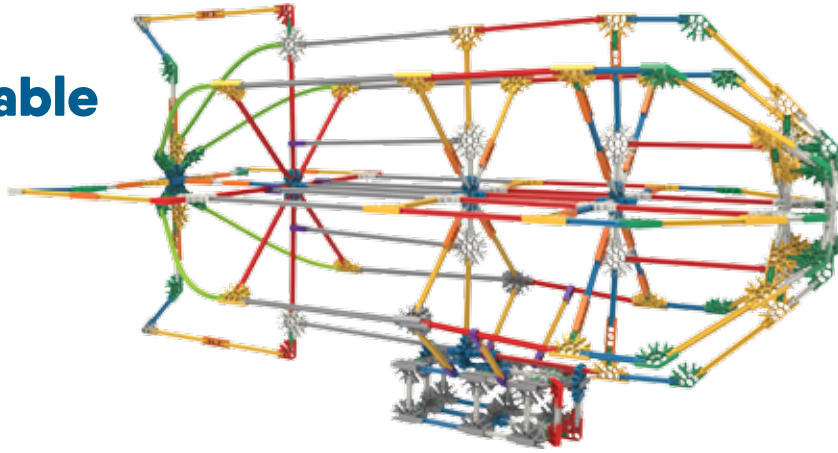

16		6	
24			
8			
16		12	

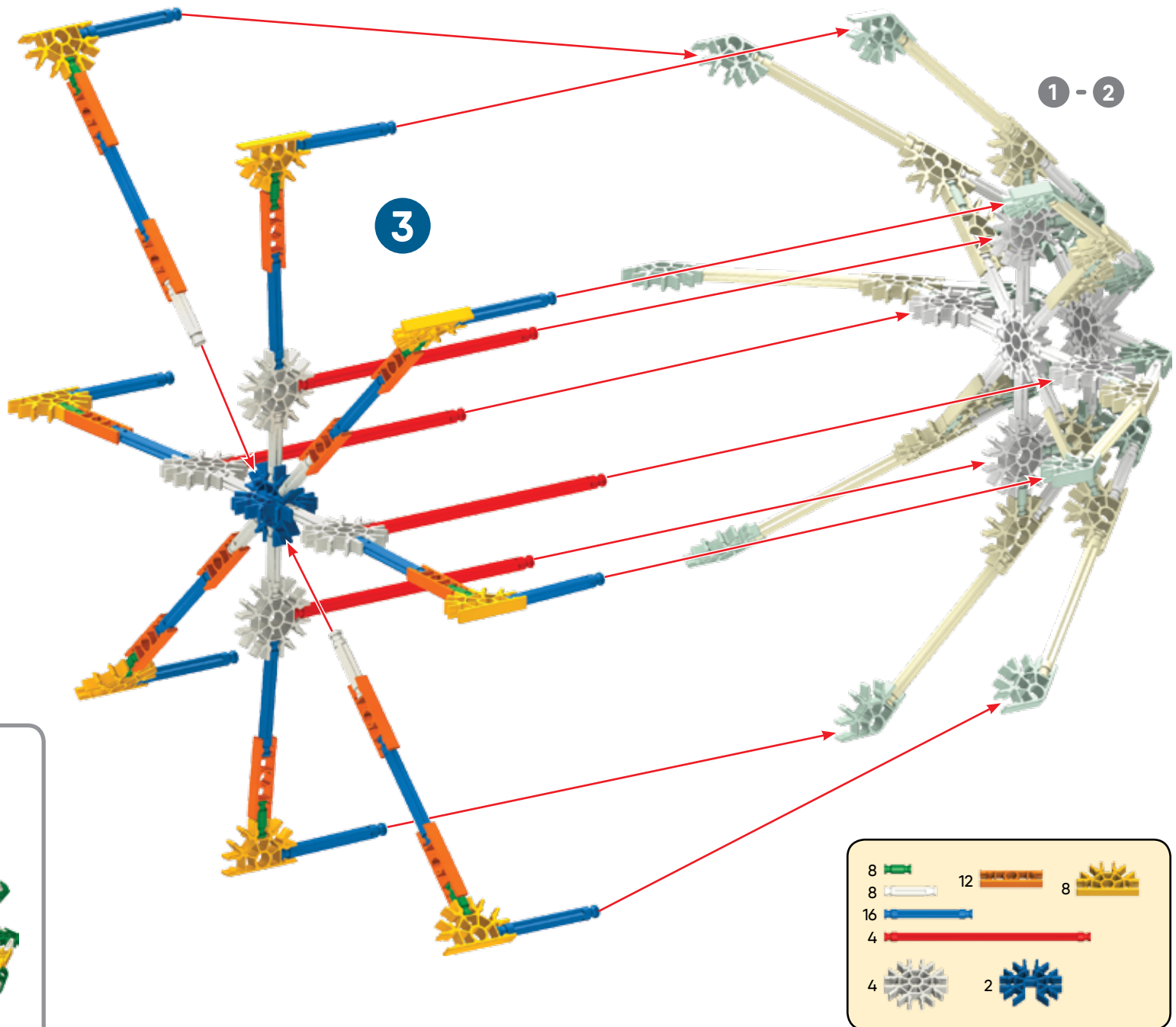

1 - 2

3



1 - 3

8		12		8	
8					
16					
4					
4					
		2			

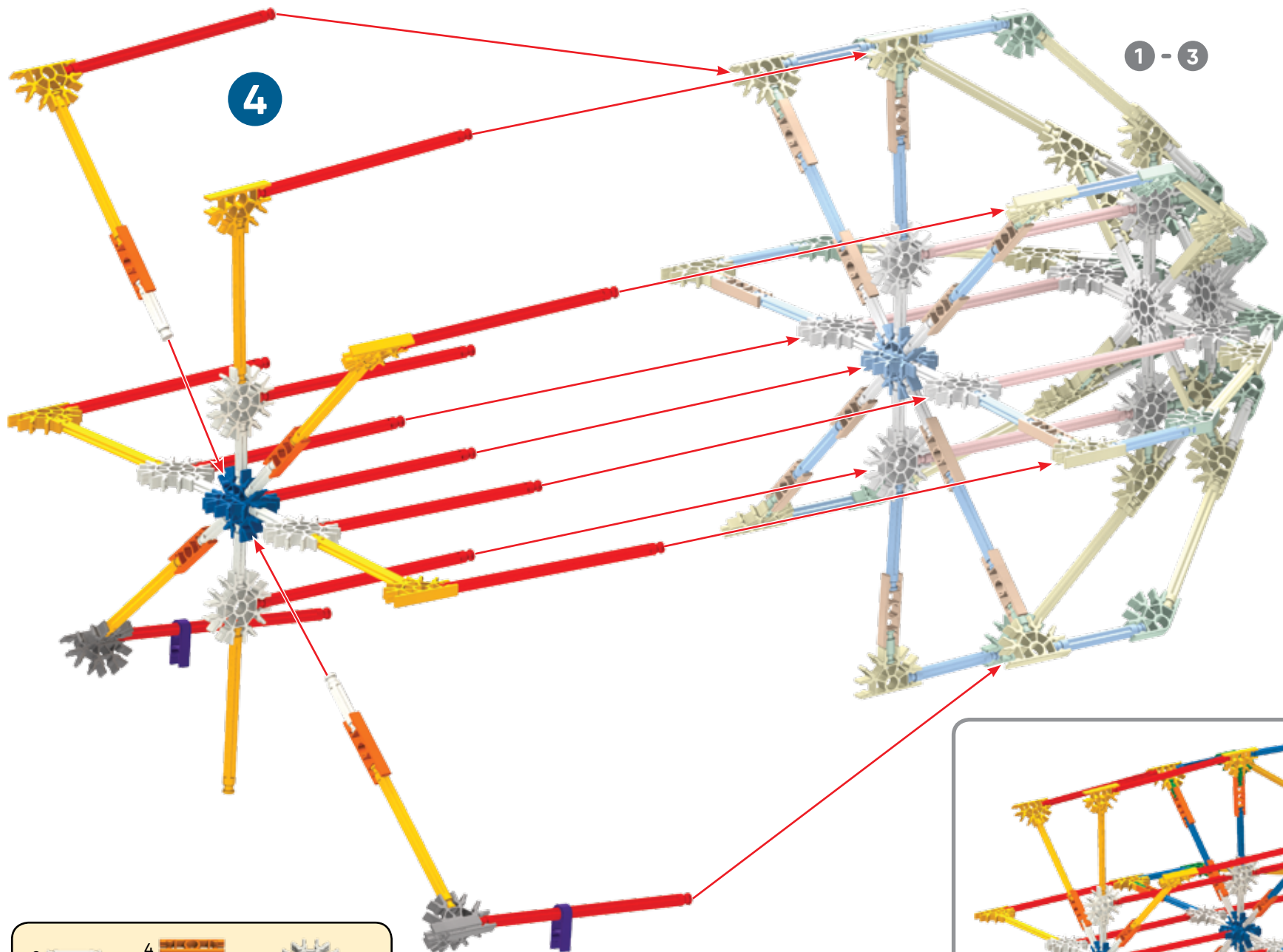

- | | | | | | |
|----|--|---|--|---|--|
| 8 | | 4 | | 4 | |
| 8 | | | | | |
| 12 | | | | | |
| 5 | | 4 | | 2 | |
| 2 | | | | | |

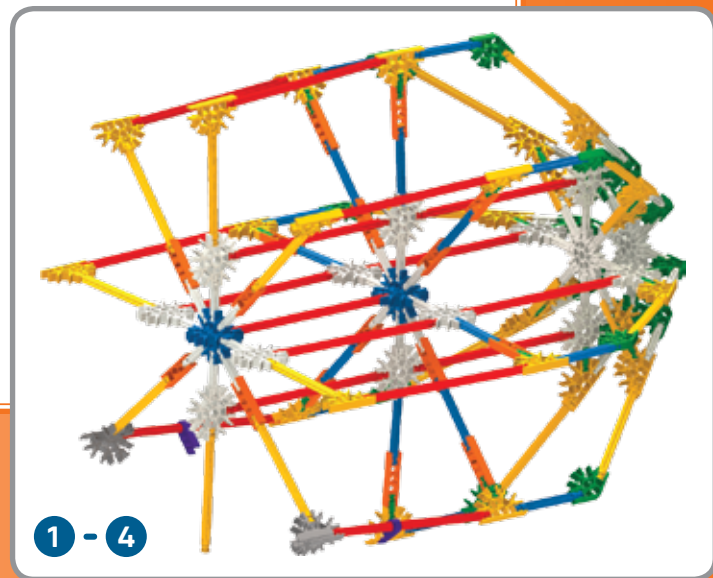

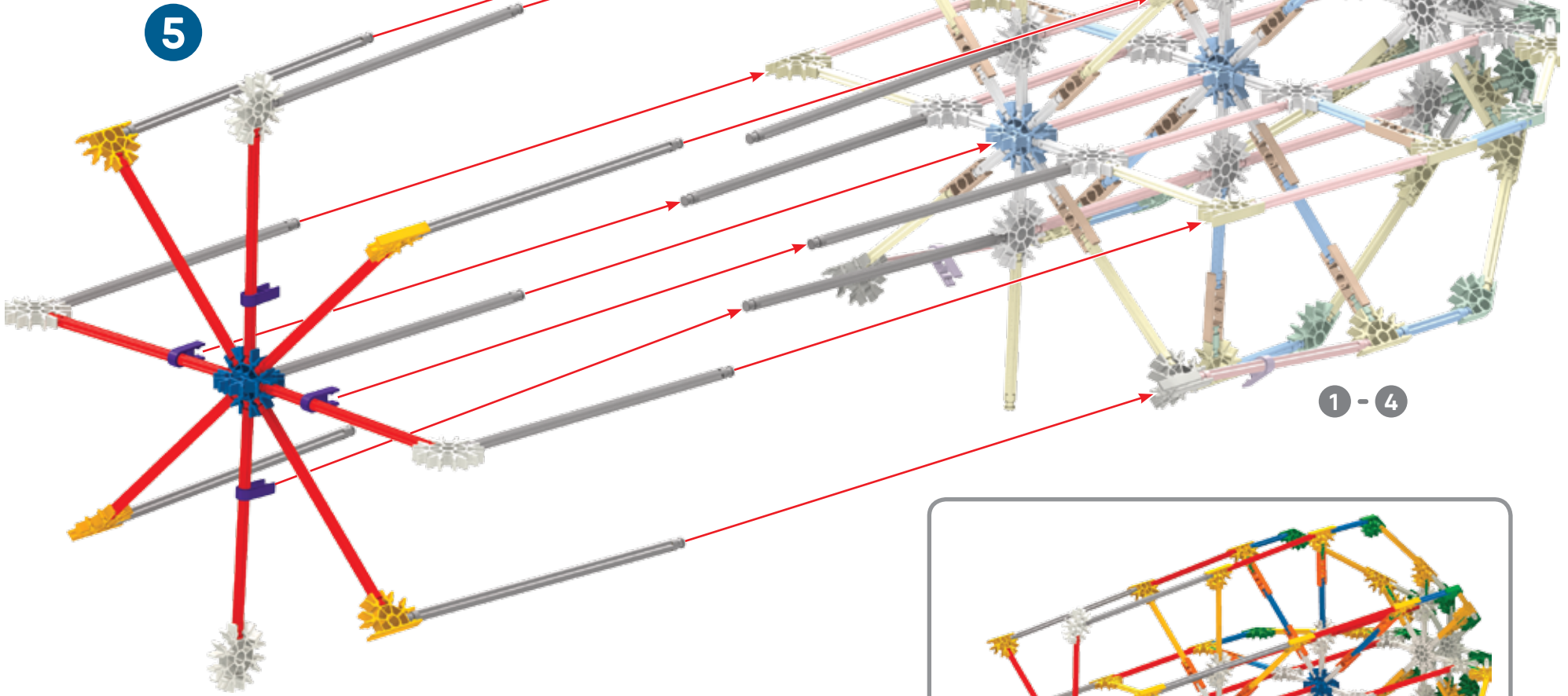
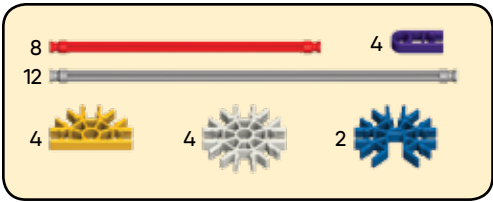

1 - 4

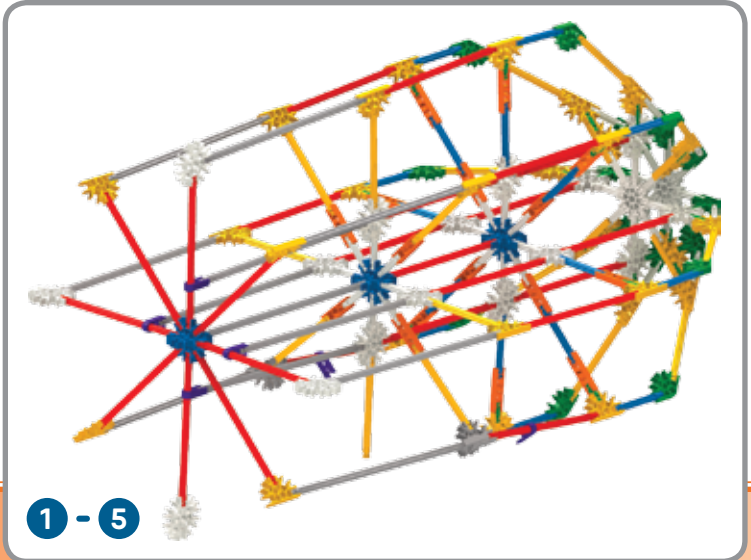

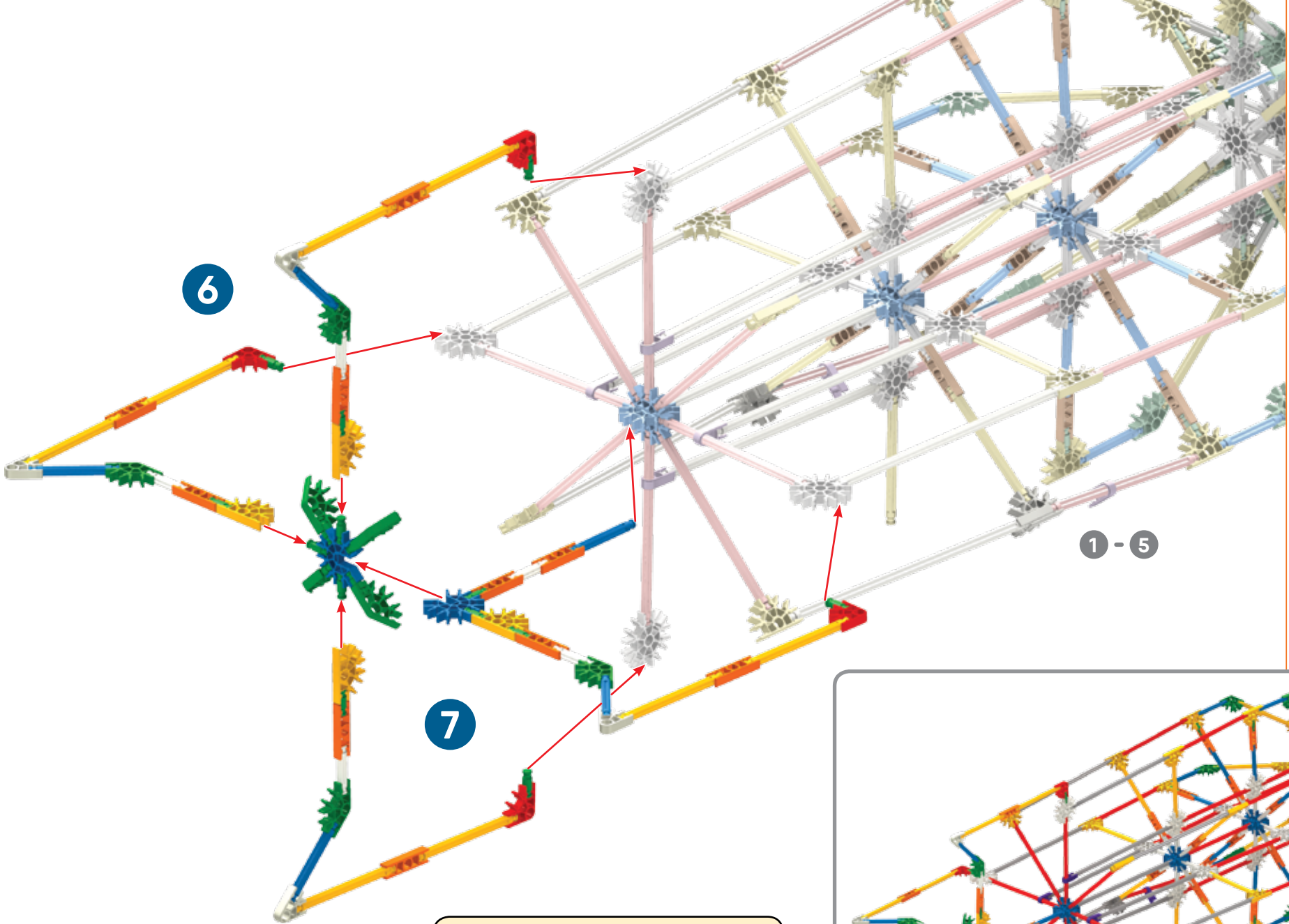

6

7

1 - 5



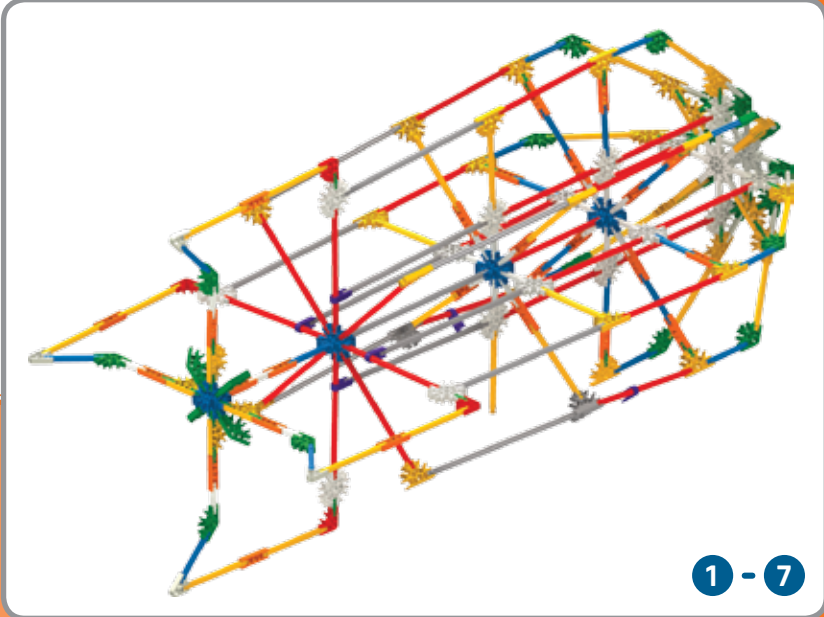

- | | | | | | |
|----|--|----|--|---|--|
| 17 | | 10 | | 2 | |
| 5 | | | | | |
| 5 | | | | | |
| 8 | | | | | |
| 4 | | 4 | | 8 | |
| | | | | 4 | |

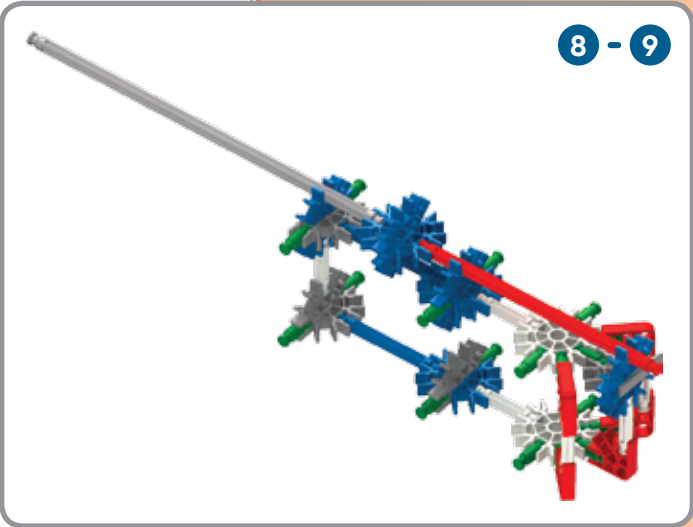
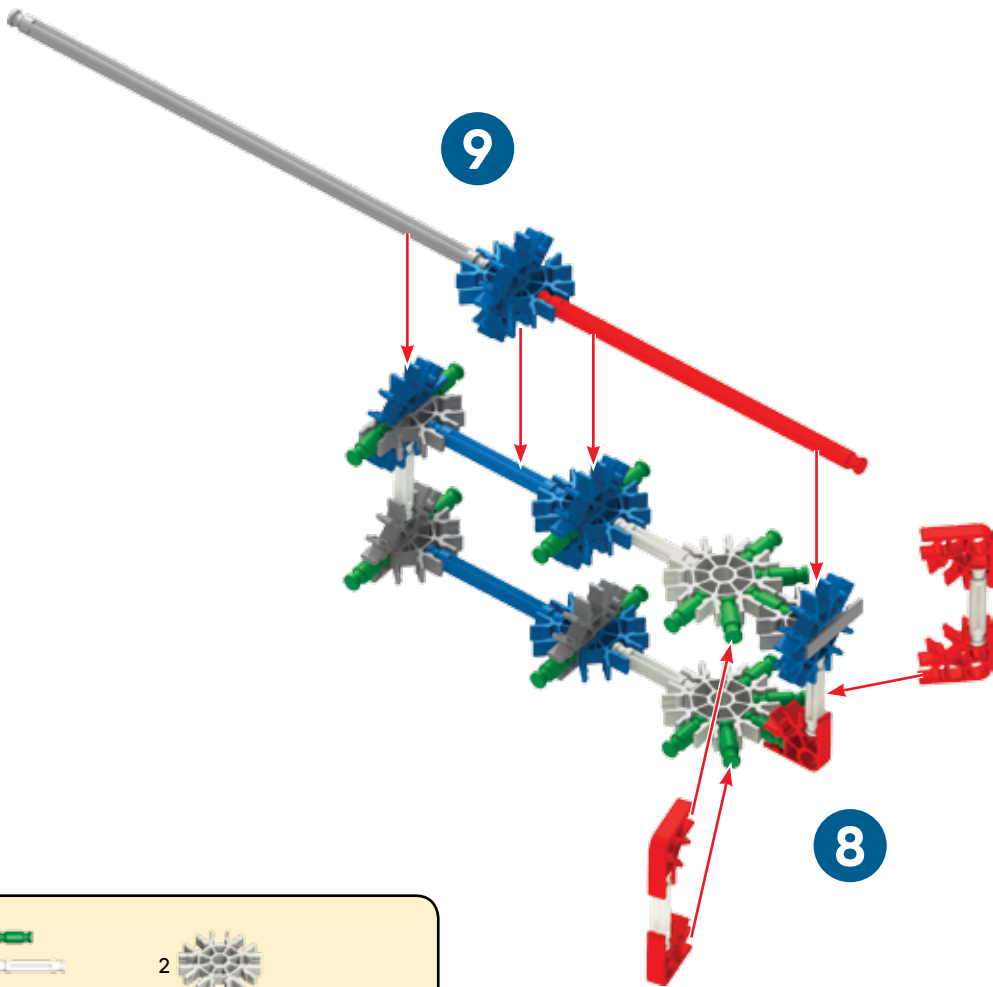

1 - 7

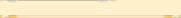

- | | | | |
|----|--|---|--|
| 18 | | | |
| 6 | | 2 | |
| 2 | | | |
| 1 | | | |
| 1 | | | |
| 5 | | 5 | |
| | | 7 | |

- 10 
- 4 
- 4 
- 4  24 

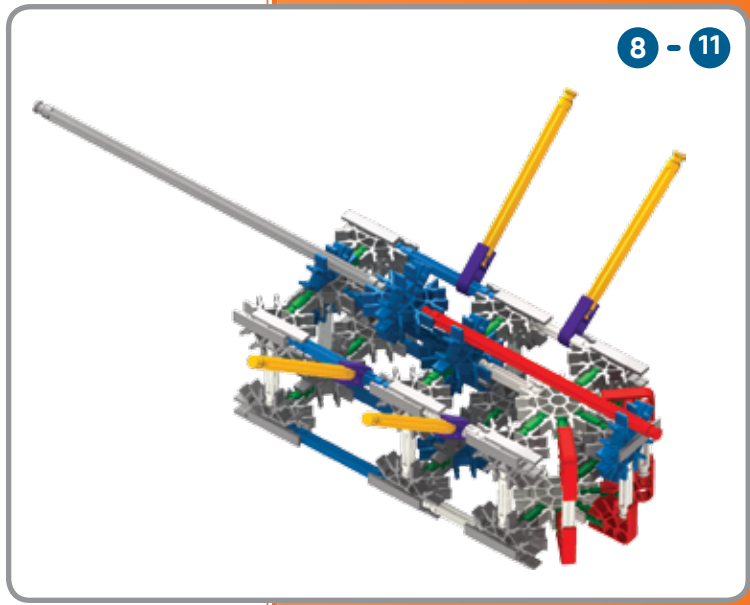
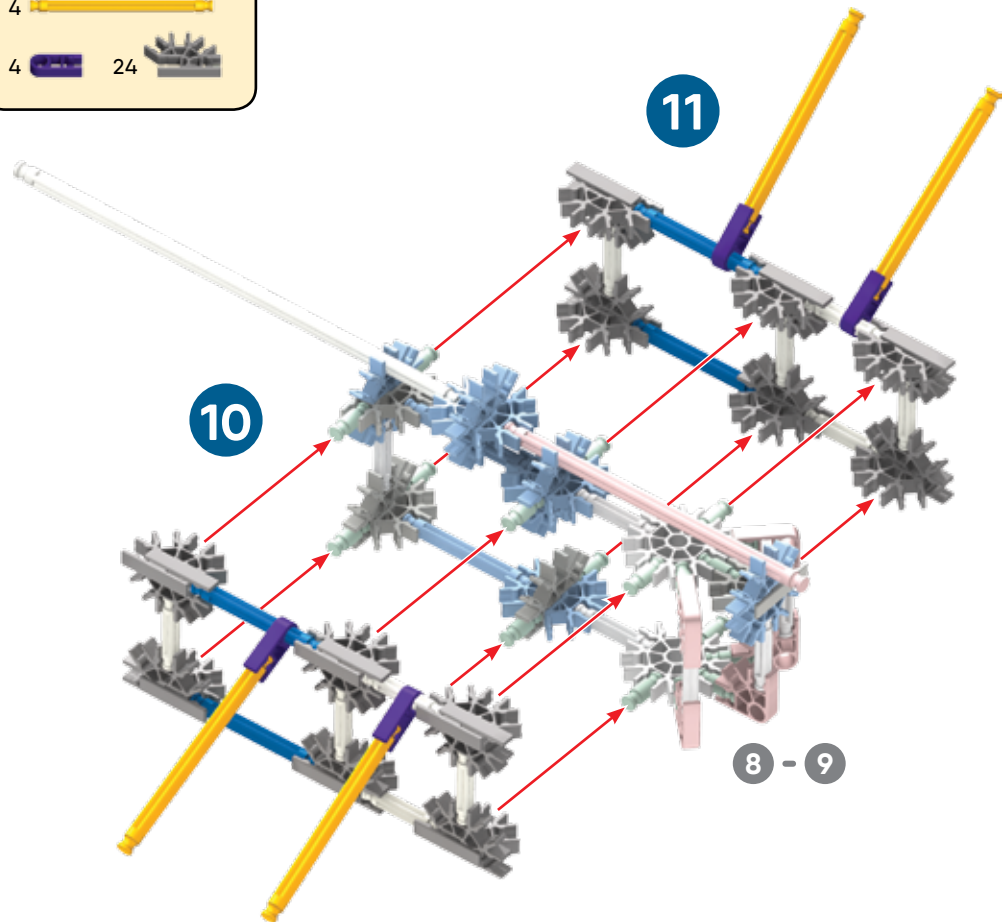

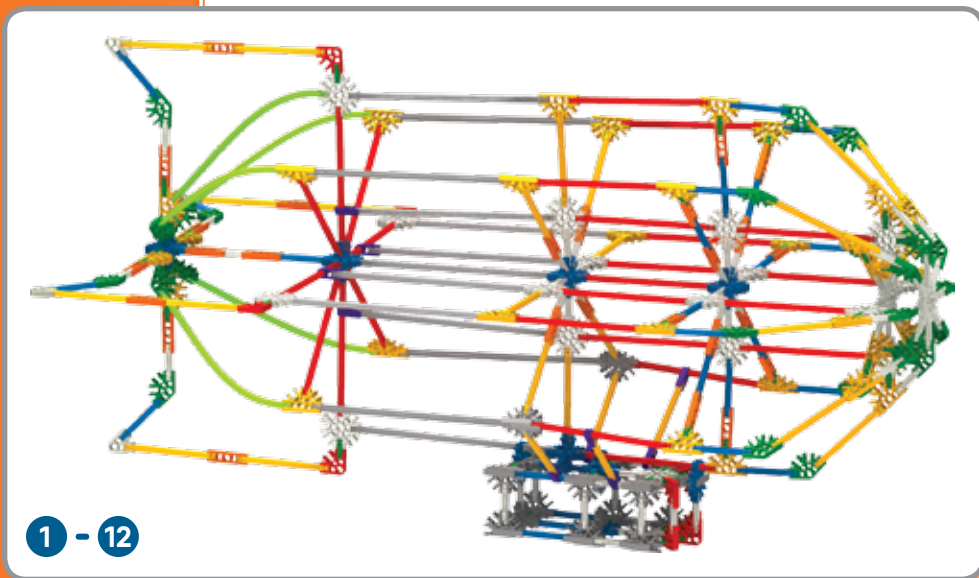
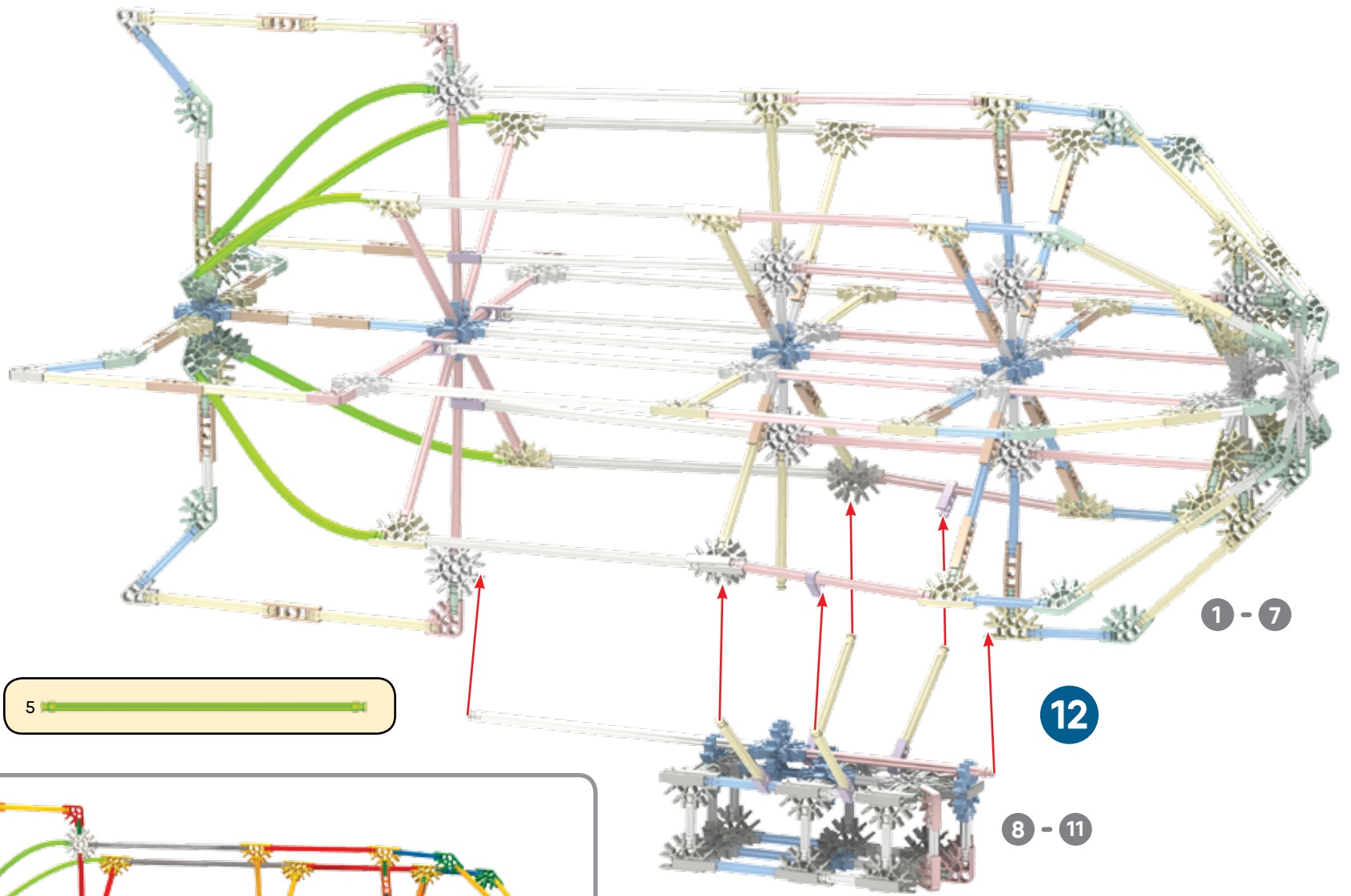









**ULTIMATE 100 MODEL
BUILDING SET
MODÈLE 100 ULTIME
JEU DE CONSTRUCTION**



**SCIENCE/SCIENCE
TECHNOLOGY/TECHNOLOGIE
ENGINEERING/INGÉNIERIE
ART & DESIGN/ART ET DESIGN
MATH/MATHÉMATIQUES***

knex.com

@knexbrands

facebook.com/knex

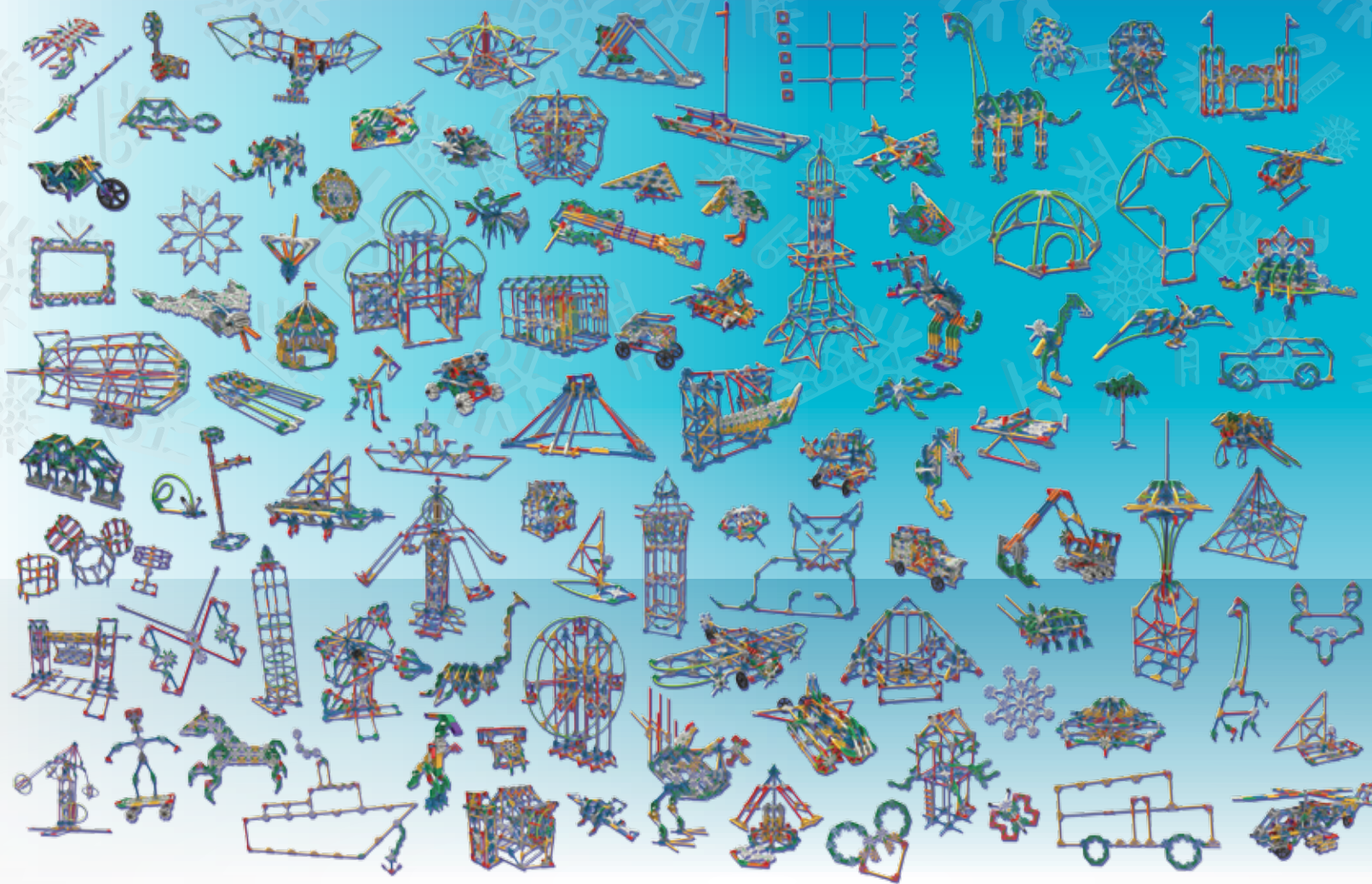

©2017 K'NEX Limited Partnership Group, P.O. Box 700, Hatfield, PA 19440-0700; 1-800-KID-KNEX (USA/Canada/États-Unis/EE.UU.); email@knex.com; knex.com. K'NEX UK Ltd, 200 Brook Drive, Green Park, Reading, RG6 2UB England; K'NEX France, 24 rue du Quatre Septembre, 75002 Paris, France. For customers outside the USA/Canada please contact your local distributor at www.knex.com/distributors.

(FR) Pour les clients en dehors du Canada et des États-Unis, veuillez contacter votre distributeur local que vous pouvez trouver sur www.knex.com/distributors.

(EN) K'NEX is a registered trademark and Imagine and Steamagination are trademarks of K'NEX Limited Partnership Group.

(FR) K'NEX est une marque déposée et Imagine et Steamagination sont une marque de K'NEX Limited Partnership Group.



**Download Our App
Téléchargez notre
application**

(EN) Product & colours may vary. Most models can be built one at a time.

(FR) Le produit et ses couleurs peuvent varier. Les différents modèles ne peuvent être construits qu'un par un.

115503-V1-06/17

