

K'nex®

AGES/ÂGE/EDADS

7+

100 Model Imagine
100 modèle imagine
100 Modelo Imagina

100

**BUILDS/
MODÈLES/
MODELOS**

You Build It!
**Vous le
Construisez!**
¡Tú lo Construyes!



WARNING:

CHOKING HAZARD – Small parts.
Not for children under 3 years.

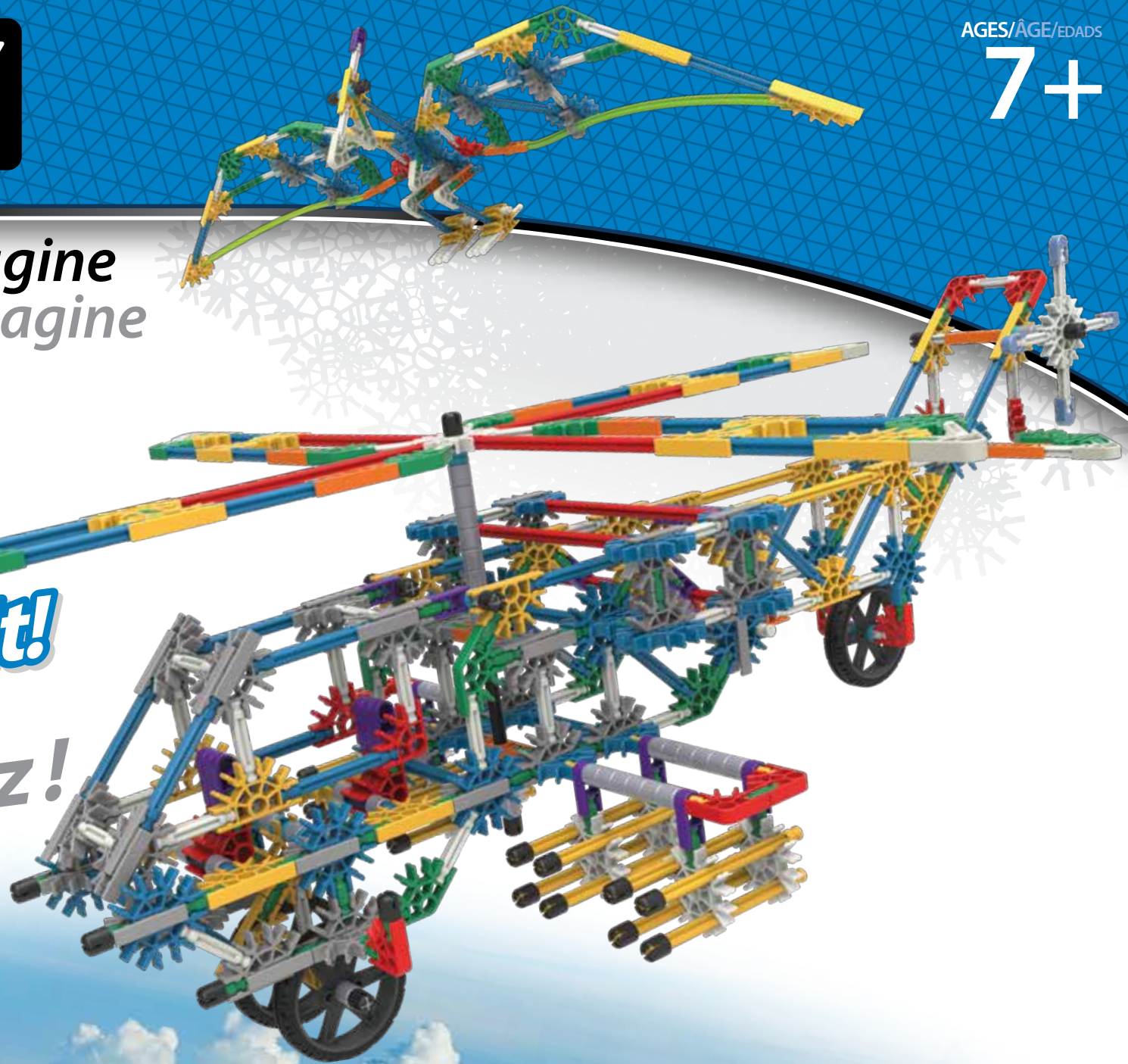

(EN) **CONTENTS**

Bus 4
Tic-Tac-Toe..... 4
Fishing Rod 5
Skateboarder 6
Motorcycle 8
Dingy..... 10
Brachiosaurus 13
Excavator..... 16
Space Shuttle..... 19
Eiffel Tower 22
Flying Saucer 26
Pod Spinner..... 31
Ambulance 36
Large Helicopter 42
Blimp..... 52
Building Ideas 60

(FR) **CONTENU**

Bus 4
Tic-Tac-Toe..... 4
Canne à Pêche..... 5
Planchiste 6
Motocyclette 8
Barque 10
Brachiosaurus 13
Pelle 16
Navette Spatiale 19
La Tour Eiffel 22
Disc Volant Non Identifié 26
Pod Tournant 31
Ambulance 36
Grand Hélicoptère 42
Dirigeable 52
Idee de Construction 60

Parts List

Before you start building, be sure to compare the parts in your set with the parts list here. If anything is missing, please visit www.Basicfun.com to contact us. We are here to help you!

Liste des Pièces

Avant de commencer à construire, assure-toi de comparer les pièces dans ta boîte à la liste de pièces fournie ici. Si quelque chose manque, veuillez visiter www.Basicfun.com pour nous contacter. Nous sommes là pour vous aider !

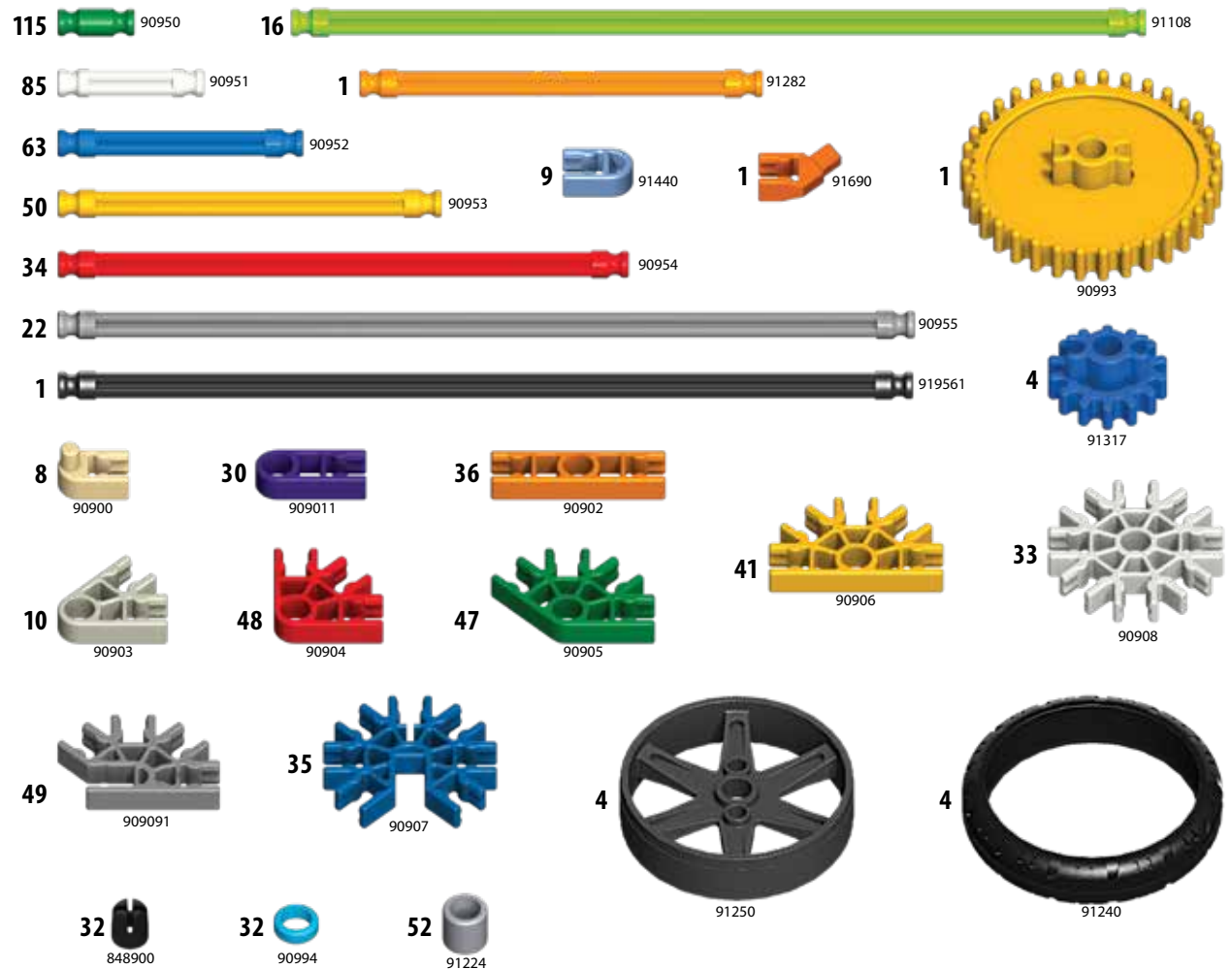



Building Basics

Bases de la Construction



Start Building

To begin your model, find the **1** and follow the numbers. Each piece has its own shape and color. Just look at the pictures, find the pieces in your set that match and then connect them together. Try to face your model in the same direction as the instructions while you build. The arrows show you where the parts connect, but not all connections points have arrows. Faded colors show you this section is already built.

Démarre ta Construction

Pour commencer ton modèle, trouve l'étape numéro **1** et suis les numéros. Chaque pièce a sa propre forme et sa propre couleur. Regarde les illustrations, trouve les pièces qui correspondent à ce que tu vois et assemble-les. Pour t'aider pendant que tu construis, oriente ton modèle dans le même sens que les instructions. Les flèches t'indiquent où les pièces s'assemblent, mais les points de raccordement n'ont pas tous des flèches. Les pièces de couleur délavée sont celles que tu as déjà assemblées.

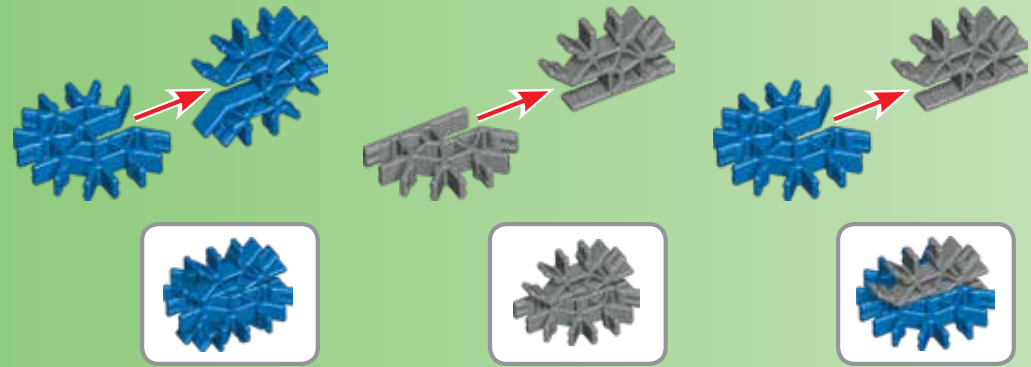

Connectors

There are blue and gray connectors with special long slots. They slide together as you see in the pictures. Push these parts together until you hear a "click."

Connecteurs

Vous pouvez assembler ces connecteurs tout à fait uniques en les faisant glisser l'un dans l'autre. Pousser fort jusqu'au « clic ». Lire les instructions attentivement et les positionner horizontalement ou verticalement, en suivant exactement les illustrations.

Spacers

There are places in your model where you need to add blue and silver spacers. Be sure to use the right color and count them carefully.



Espaceurs

Il y a des endroits sur ton modèle où tu auras besoin de te servir d'espaceurs. Assure-toi d'utiliser la bonne couleur et le nombre d'espaceurs indiqué sur les instructions.

Flexible Rods

You can bend a flexible rod to make curved shapes. It will be easier to attach to your model if you bend it back and forth a few times first.



Tiges Flexibles

Un tiges flexibles est une tige que tu peux courber pour faire des courbes. Elle pourra être attachée plus aisément à ton modèle si tu la plies en avant et en arrière plusieurs fois.

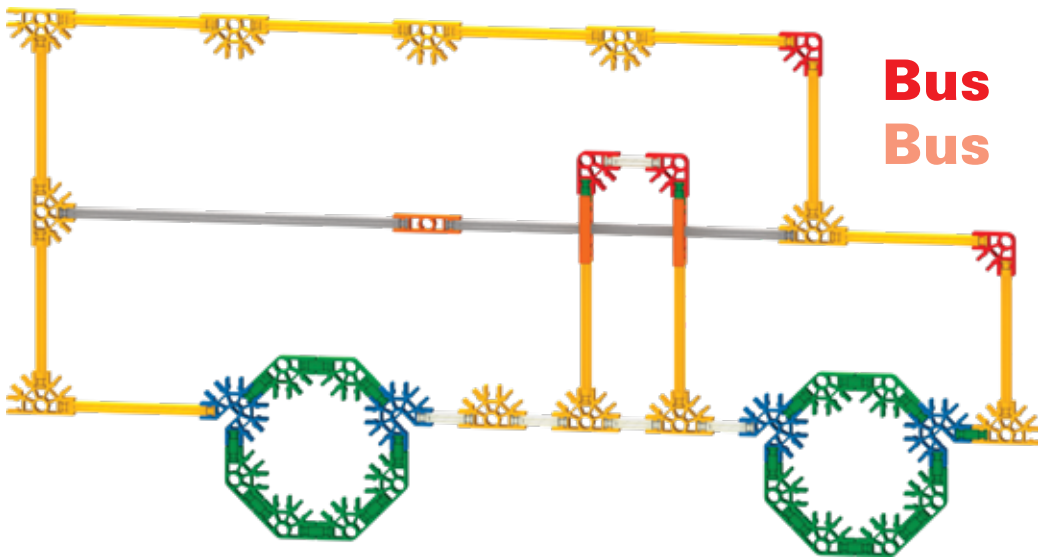

Bus
Bus



Tic-Tac-Toe
Tic-Tac-Toe

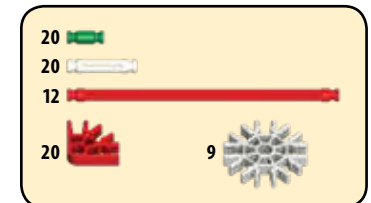
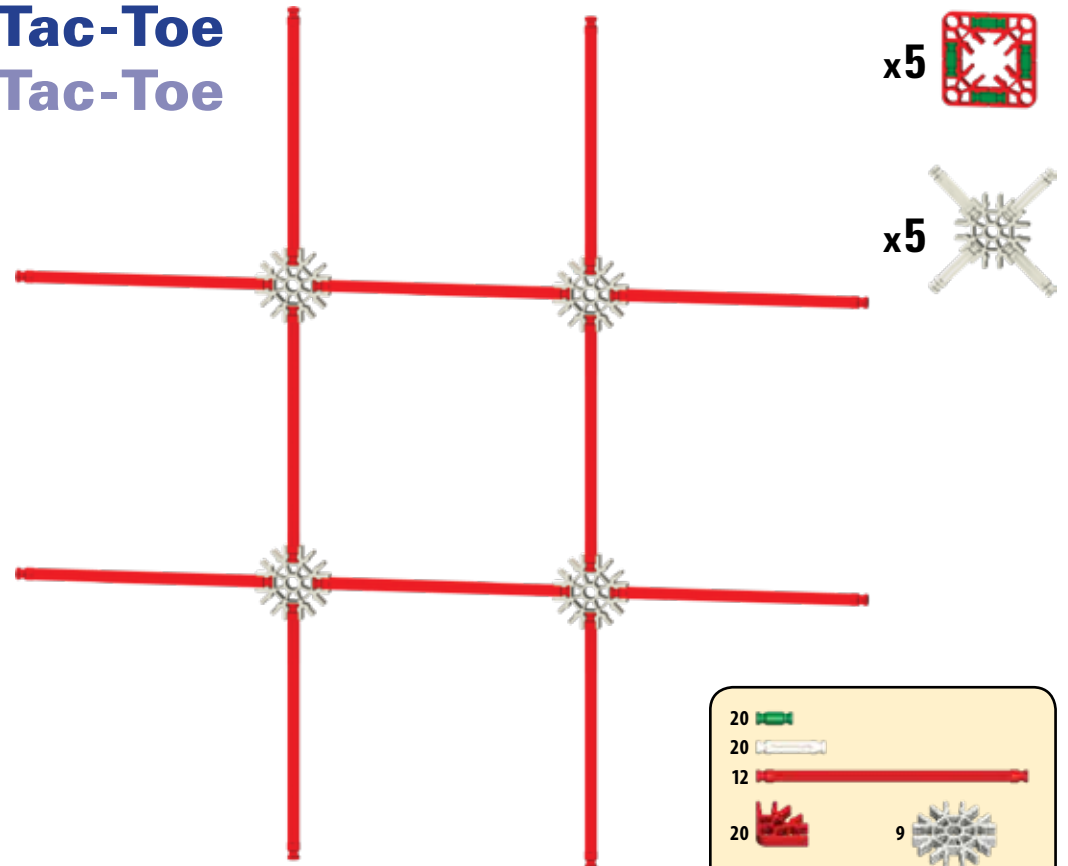

! (EN) **WARNING: CHOKING HAZARD** - Small parts. Not for children under 3 years.

(FR) **ATTENTION** : RISQUE D'ÉTOUFFEMENT - Pièces de petite taille. Ne convient pas aux enfants de moins de 3 ans.

(ES) **ADVERTENCIA**: PELIGRO DE ASFIXIA - Piezas pequeñas. No para niños menores de 3 años.

(DE) **ACHTUNG**: ERSTICKUNGSGEFAHR - Kleinteile. Nicht geeignet für Kinder unter 3 Jahren.

(IT) **AVVISO**: PERICOLO DI SOFFOCARE - Pezzi piccoli parti. Non adatto per bambini sotto di 3 anni.

(PT) **AVISO**: PERIGO DE SUFOCAÇÃO - Peças pequenas. Não se destina a crianças com menos de 3 anos de idade.

(NL) **WAARSCHUWING**: VERSTIKKINGSGEVAAR - Kleine onderdelen. Niet geschikt voor kinderen jonger dan 3 jaar.

Skateboarder Planchiste



- 4 
- 14 
- 10 
- 2 
- 4 
- 4 
- 3 
- 1 
- 1 
- 2 

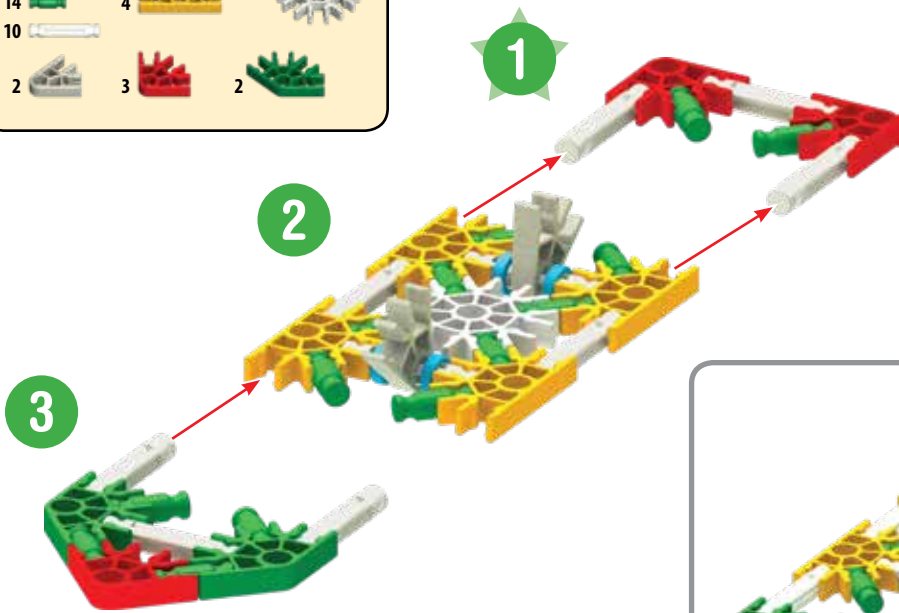



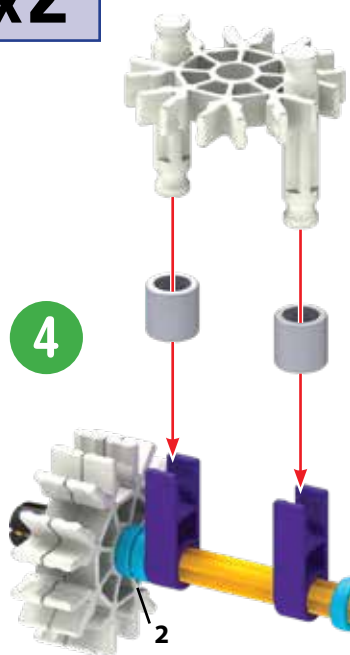

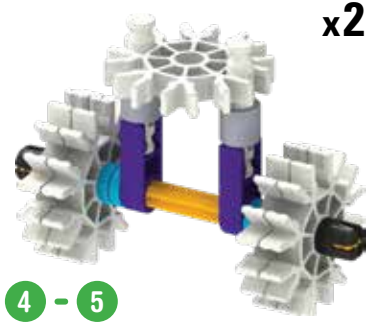

x2



4 - 5



x2

- 4 
- 4 
- 2 
- 4 
- 8 
- 4 
- 10 

5

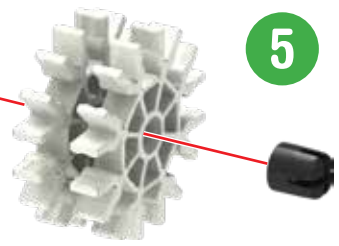

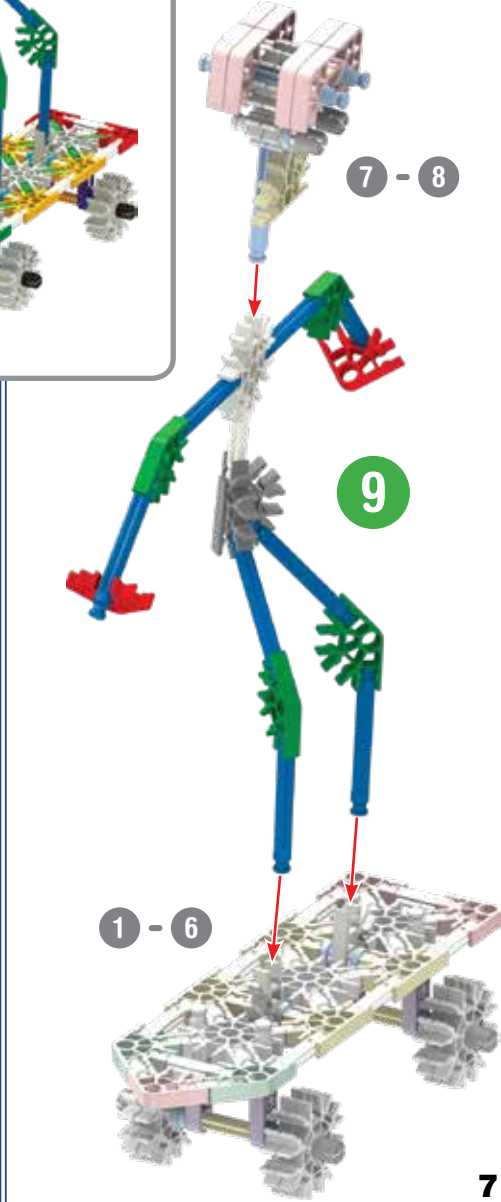
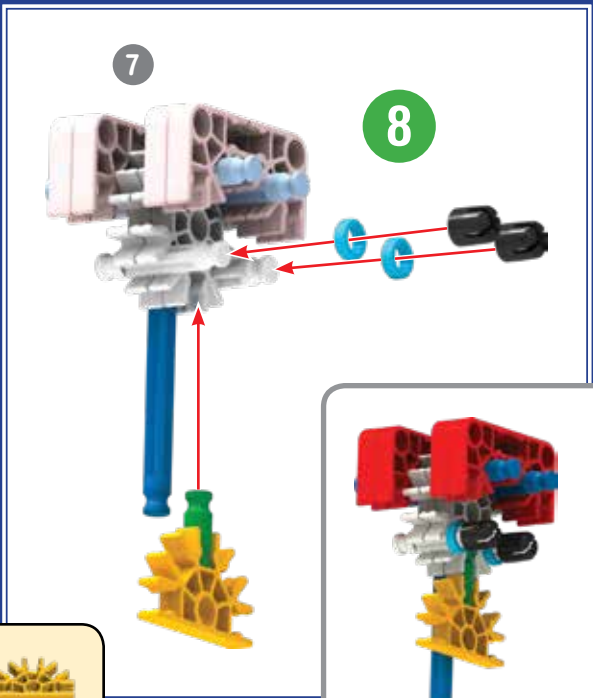
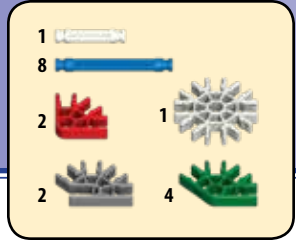
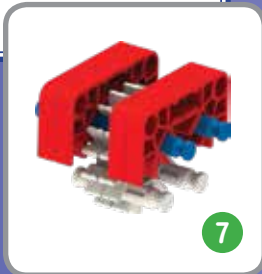
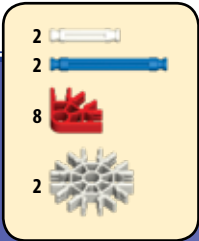
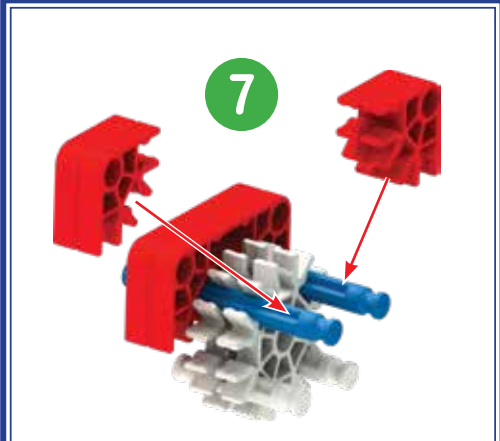
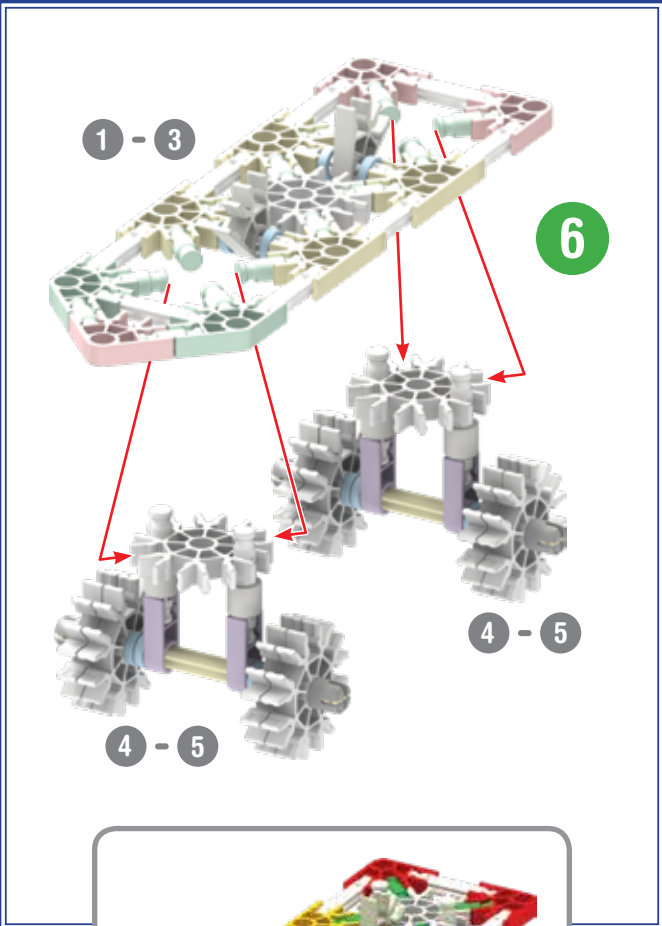

Motorcycle Motocyclette

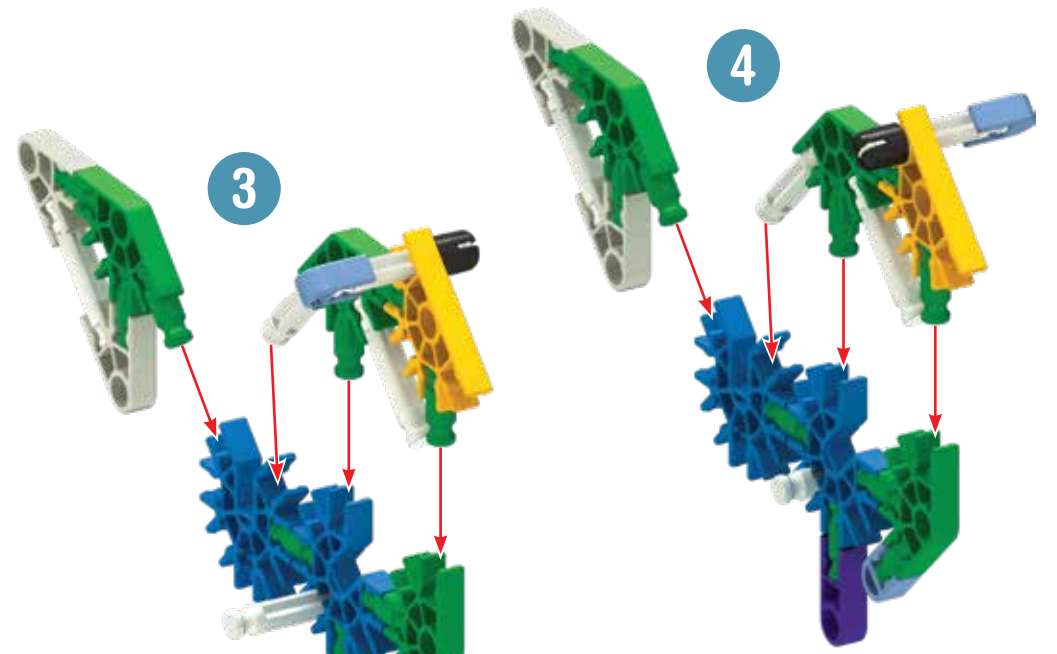
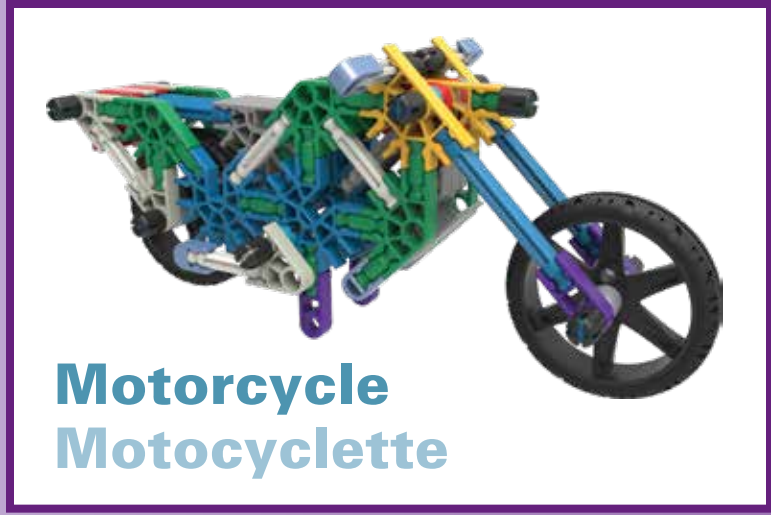

1

6	1	1	1
1	1	1	1
1	1	1	1
1	1	1	1
1	1	1	1

20	2	4	6	4
10	1	1	1	1
2	4	2	1	1

2 **x2**

3 - 4

1

10	2	2	2
2	2	2	2
2	2	2	2
4	2	4	4

2 **x2**

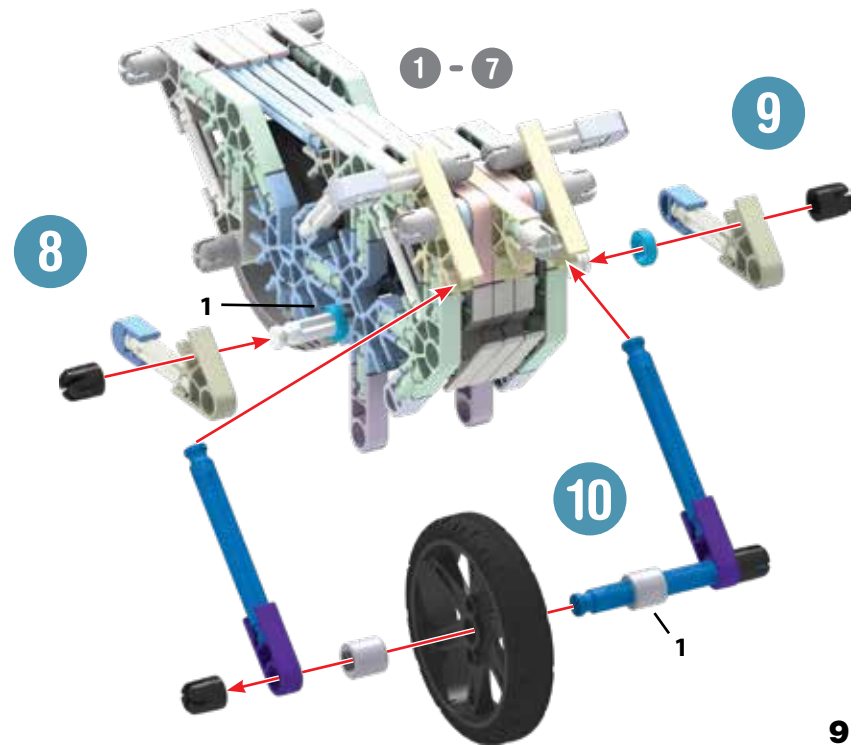
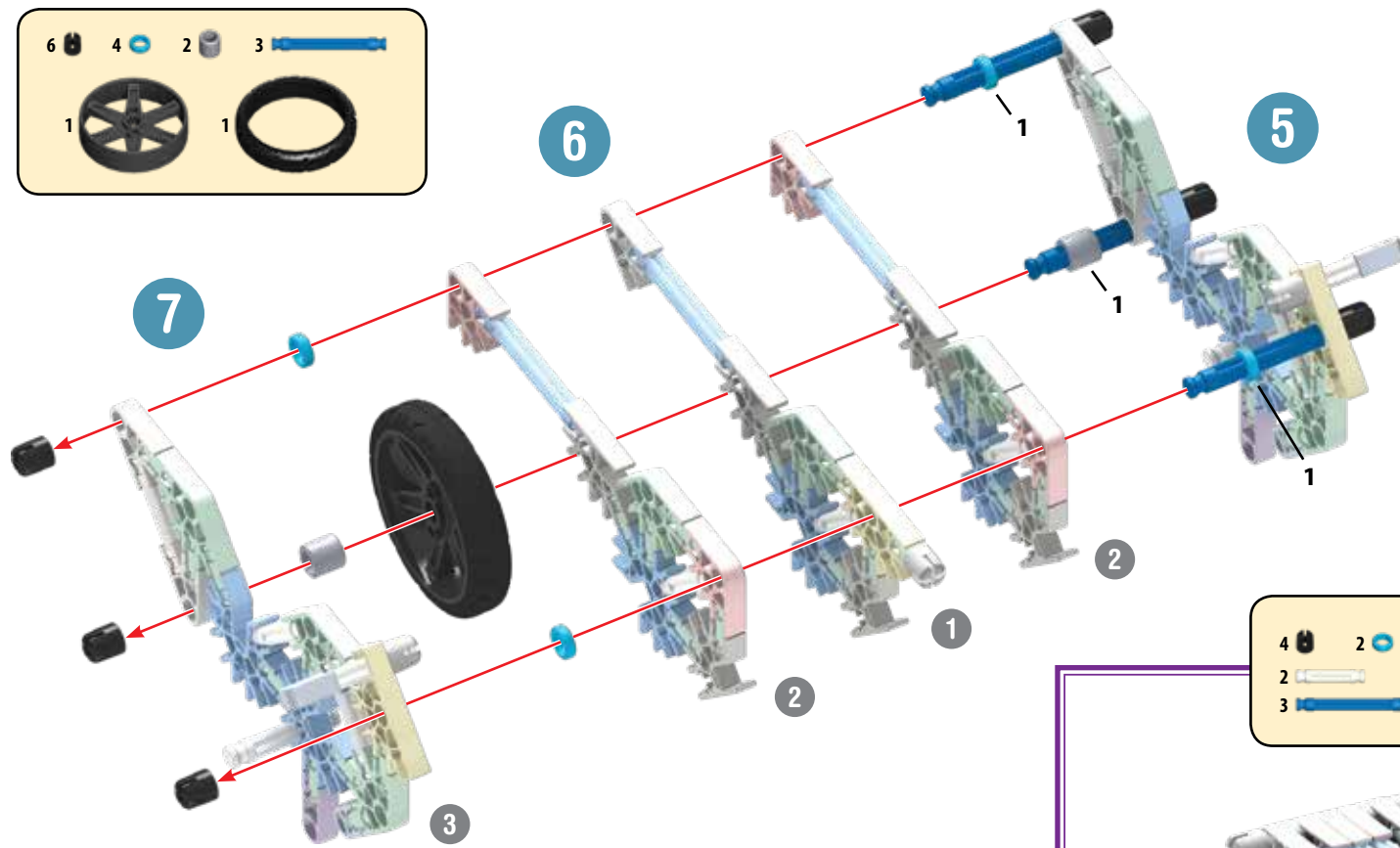
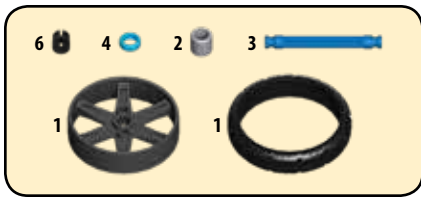

Dingy Barque

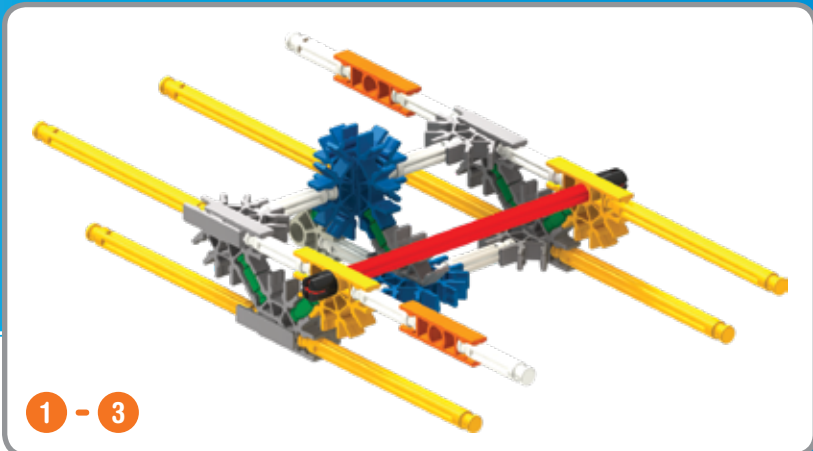

- | | | | | | | |
|----|--|---|--|---|--|---|
| 6 | | 2 | | 2 | | |
| 11 | | | | | | 3 |
| 7 | | | | | | |
| 1 | | | | | | |
| 1 | | 2 | | 9 | | |

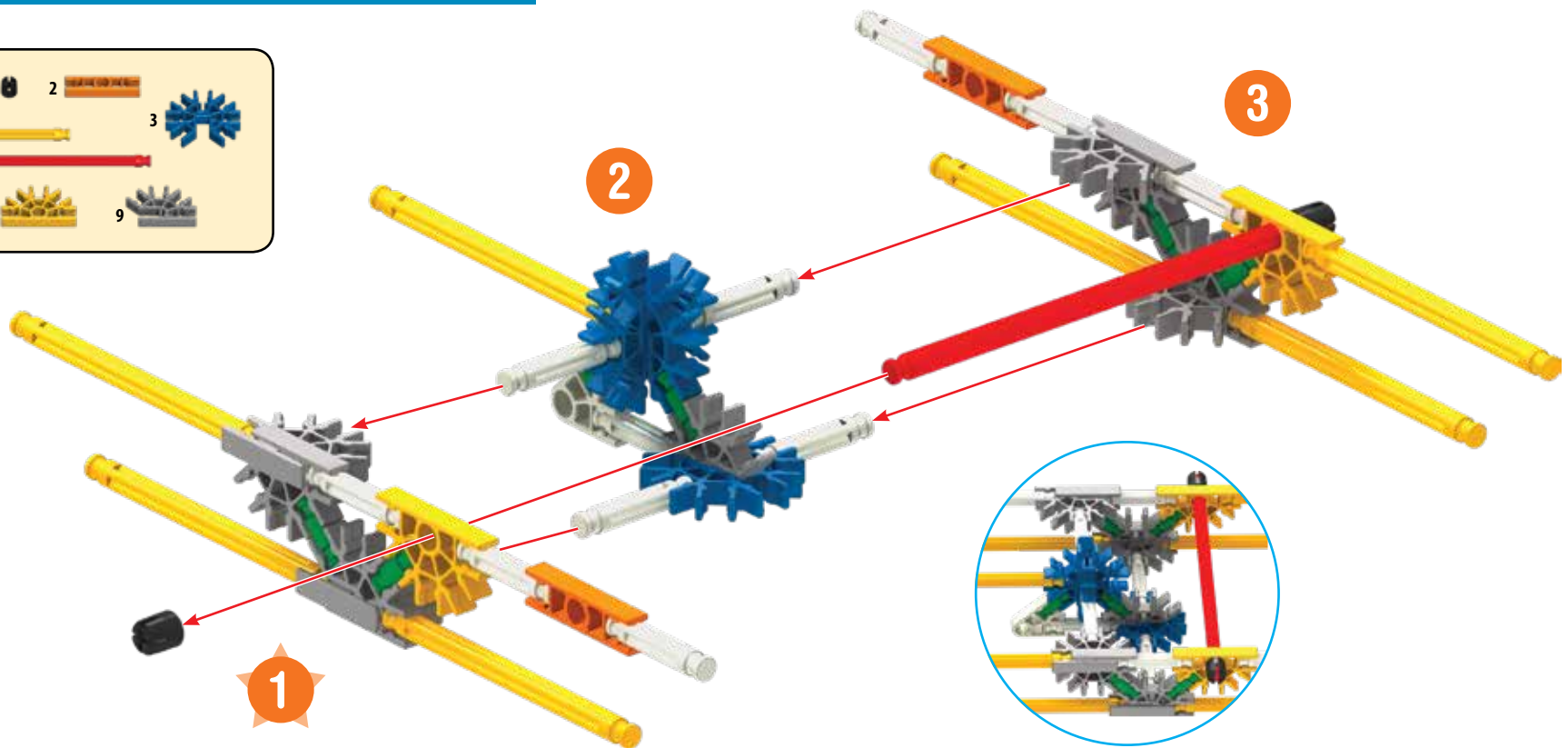

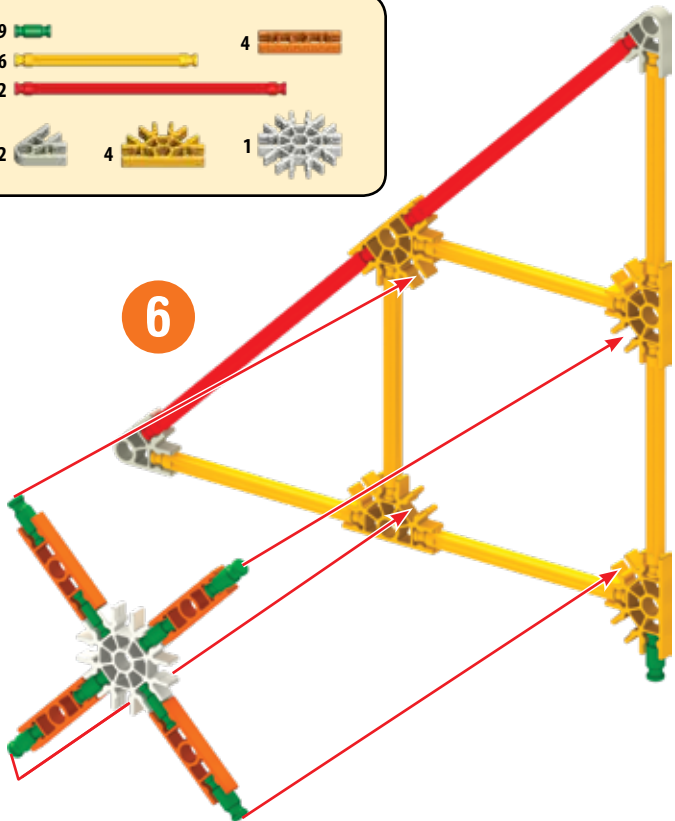
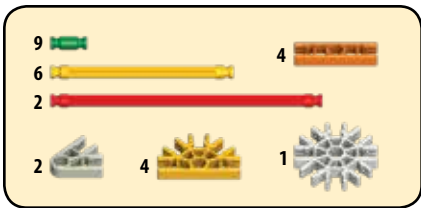
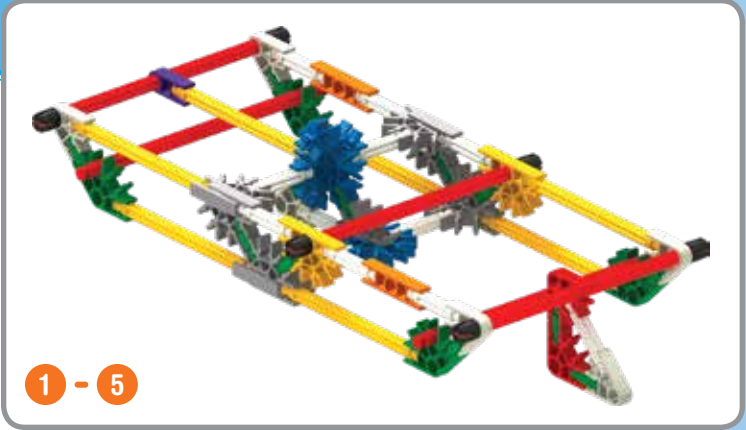
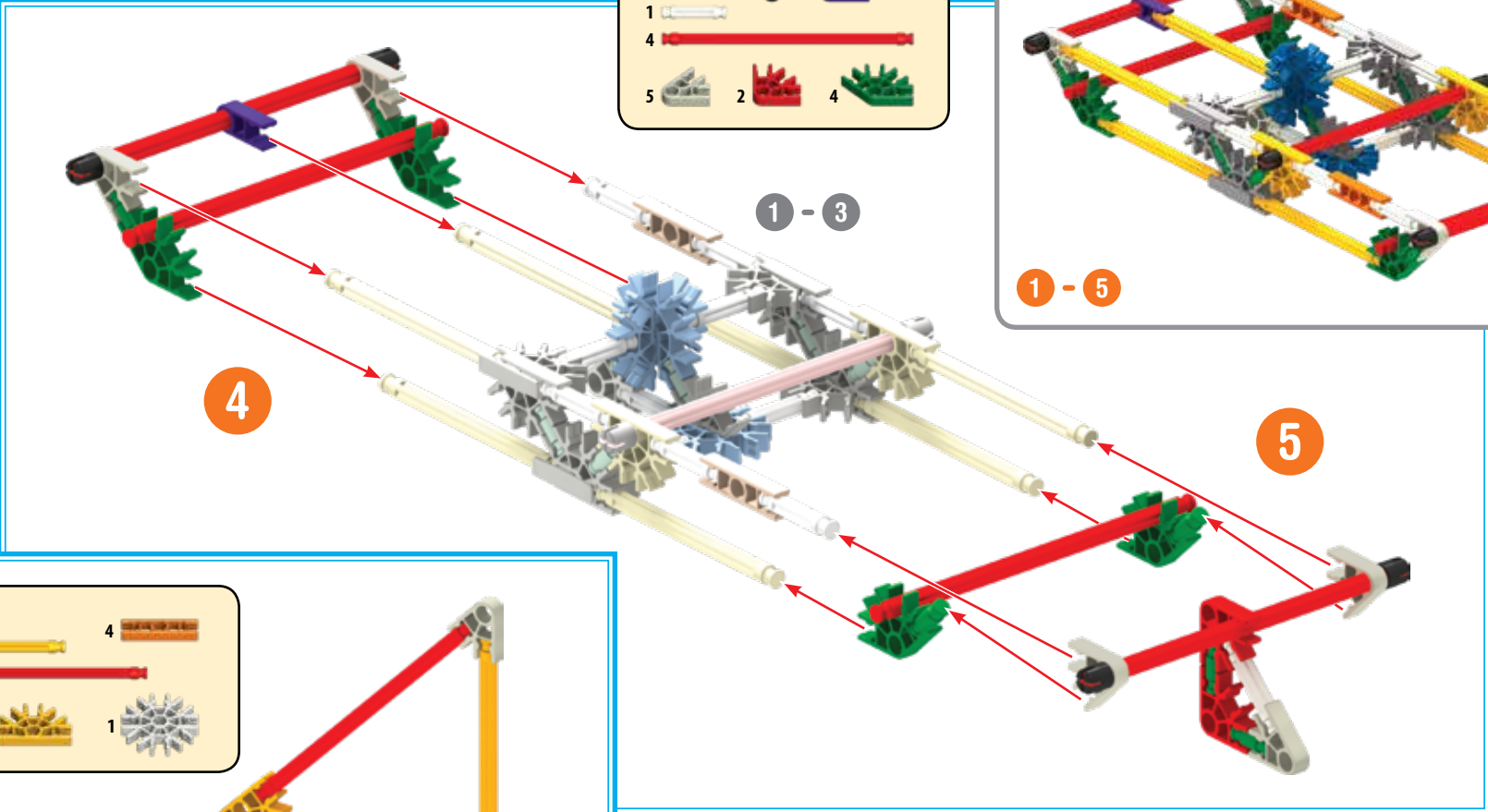
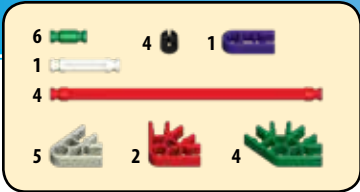

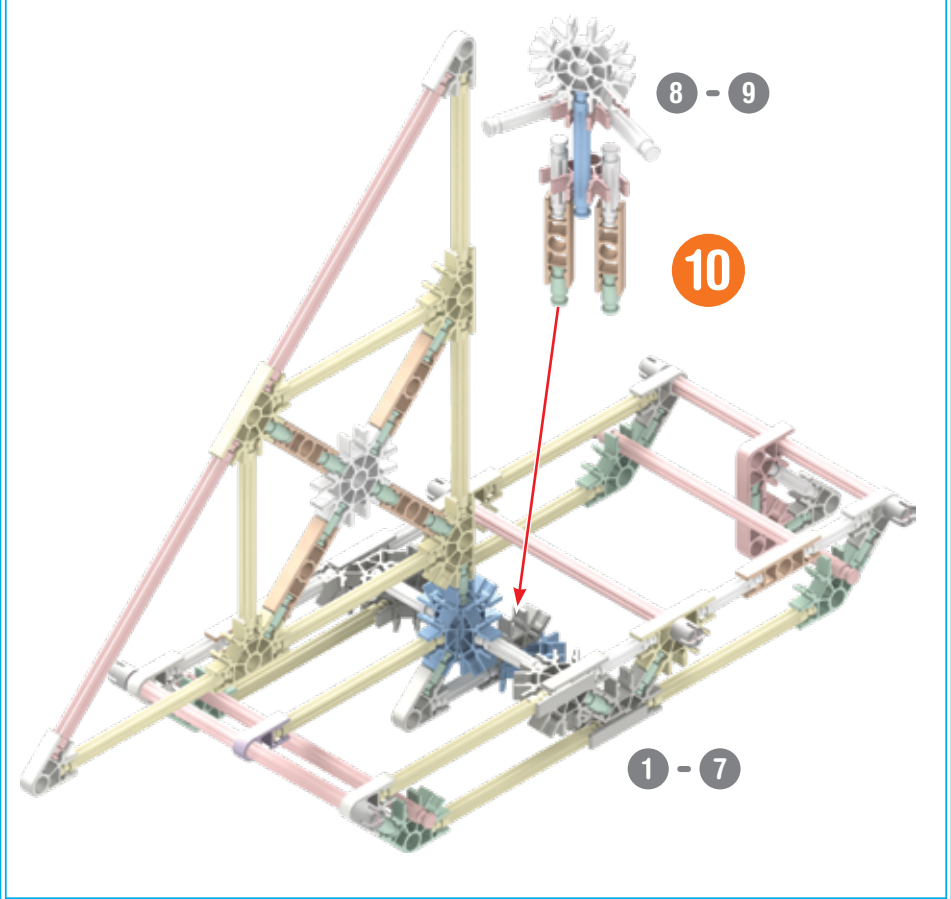
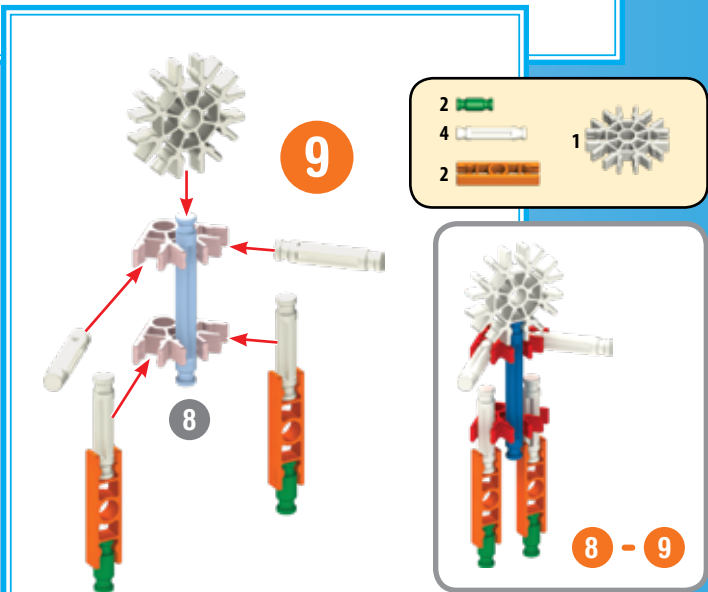
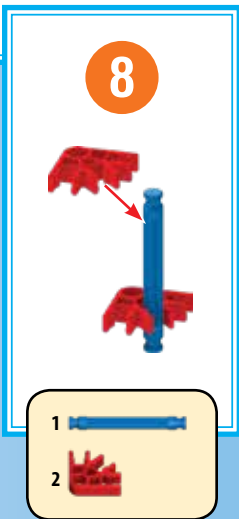
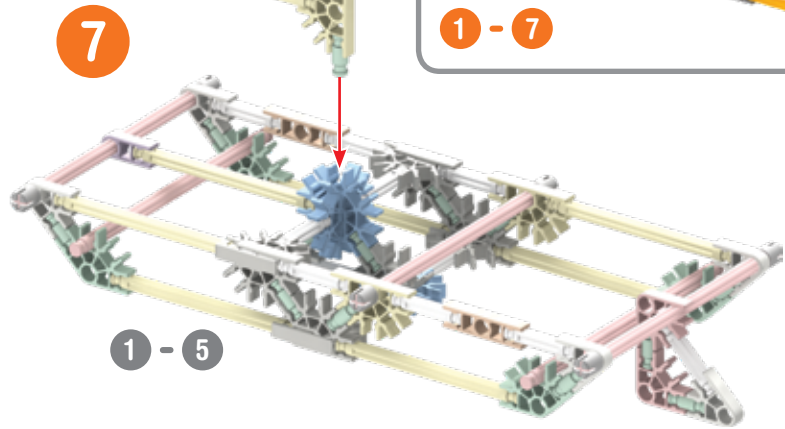
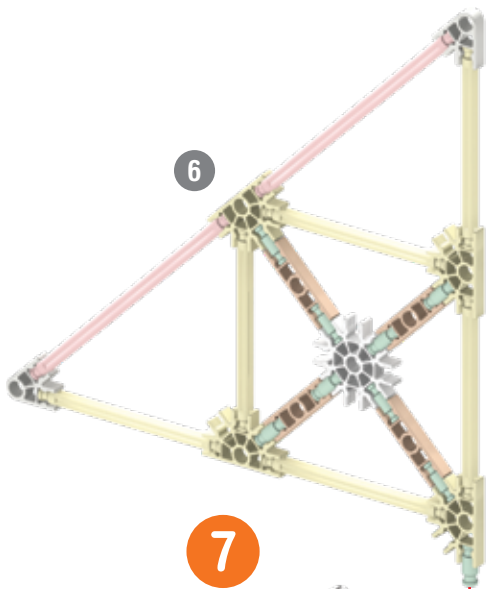

Brachiosaurus

Brachiosaurus

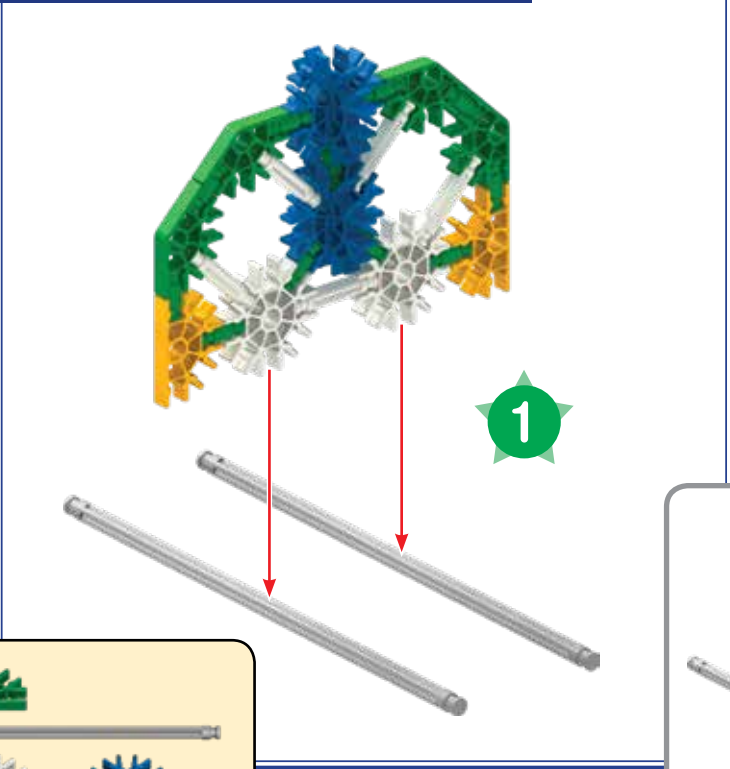

11		4	
5		2	
2		2	
2		2	
		4	

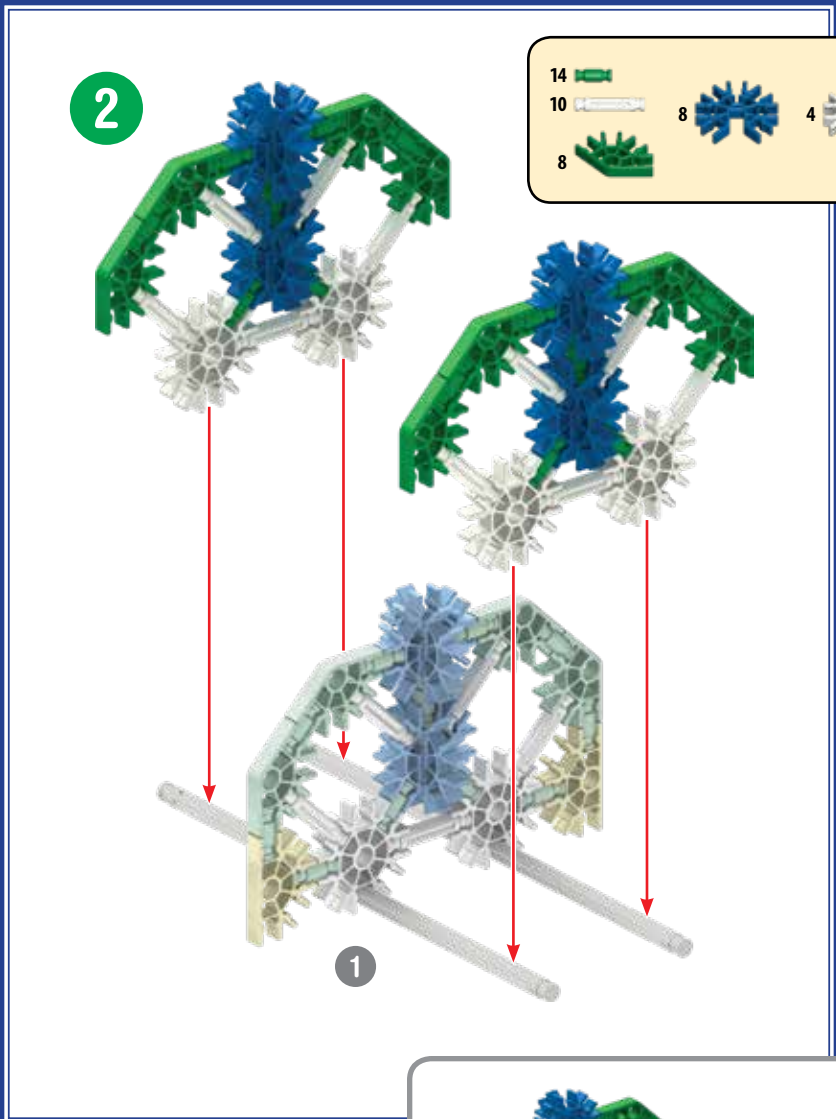

14		8		4	
10					
8					

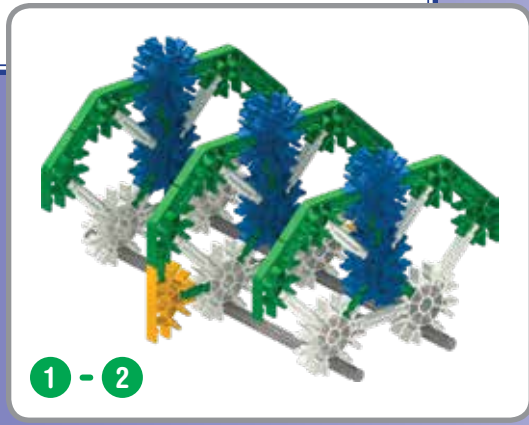
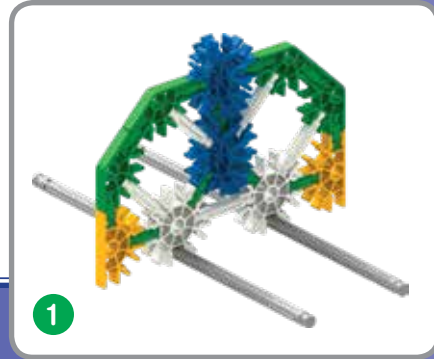

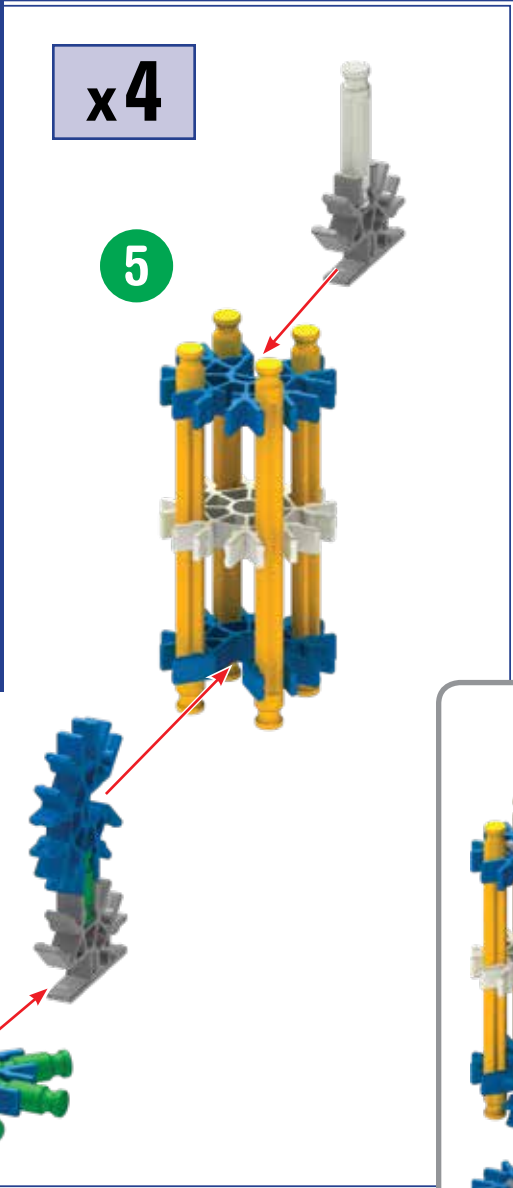
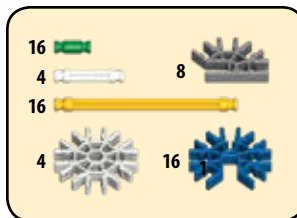
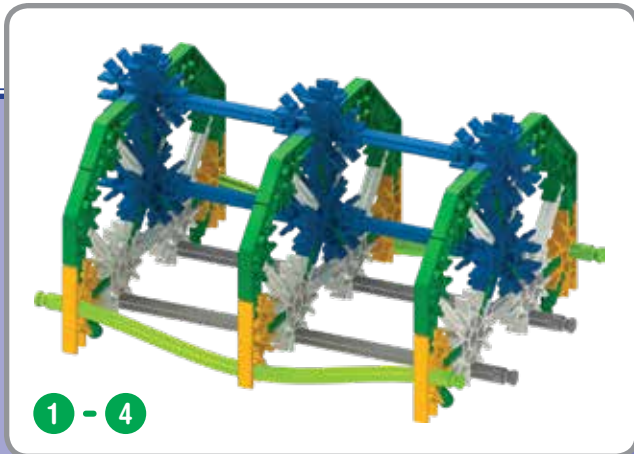
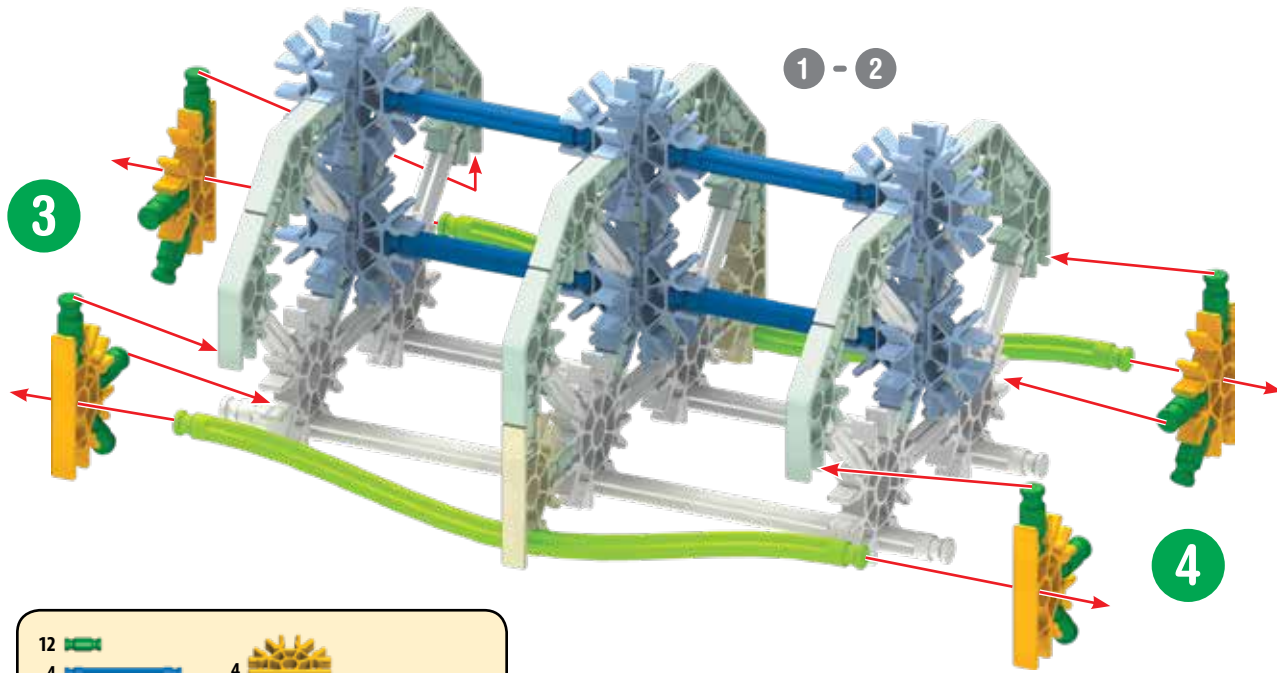

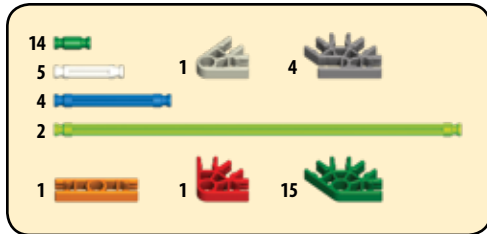
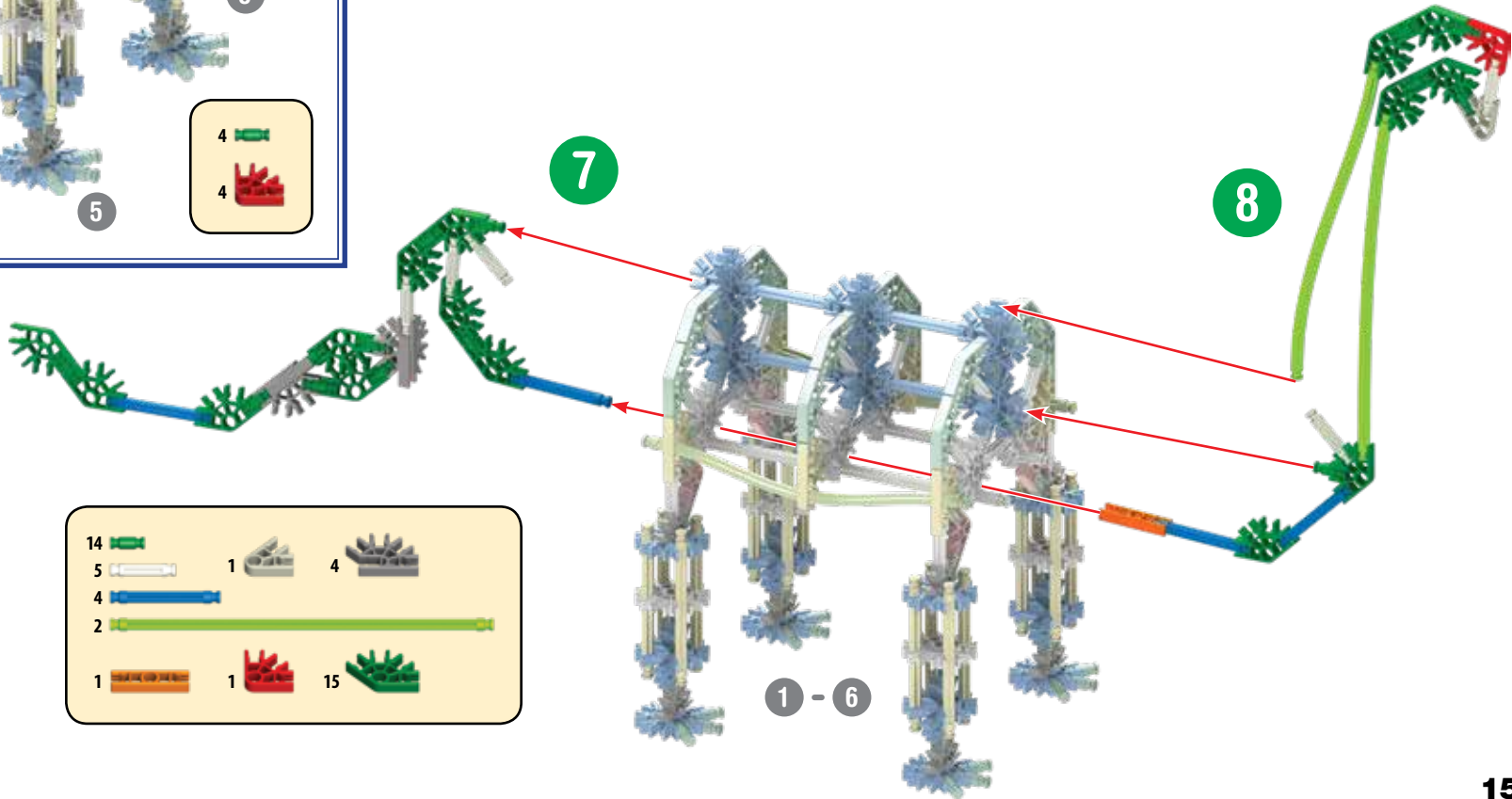
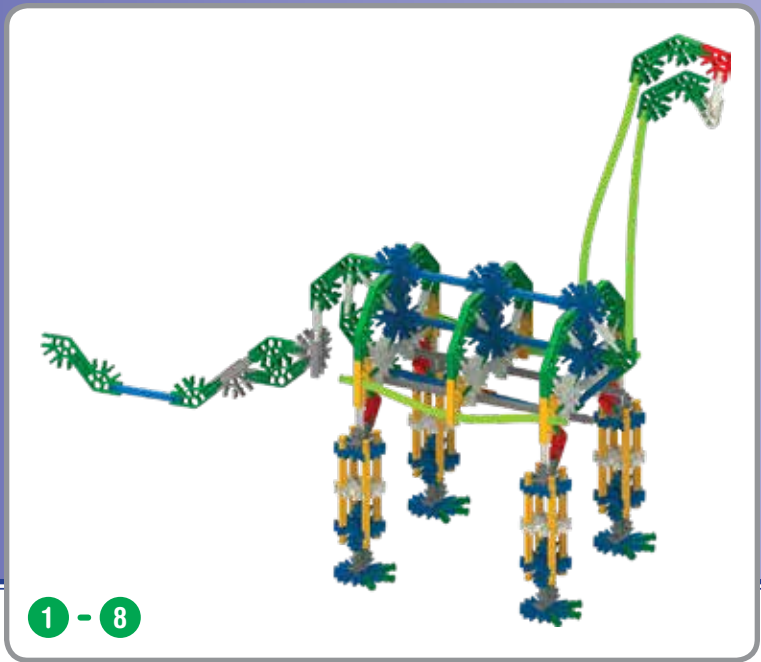
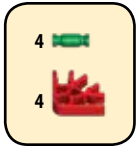
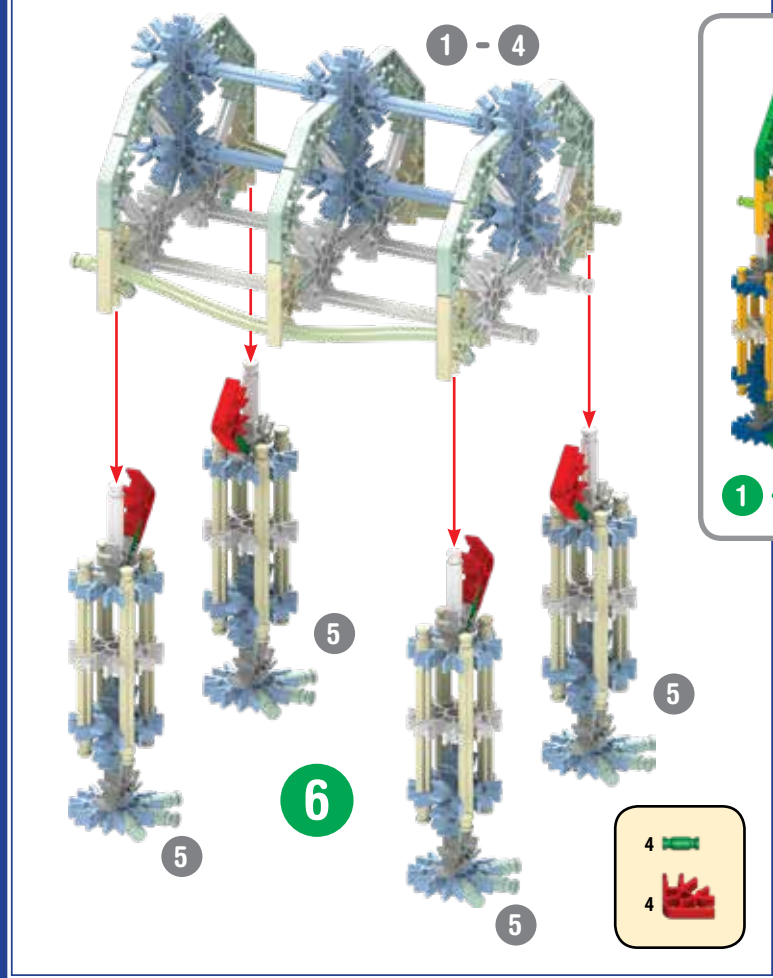

Excavator Pelle

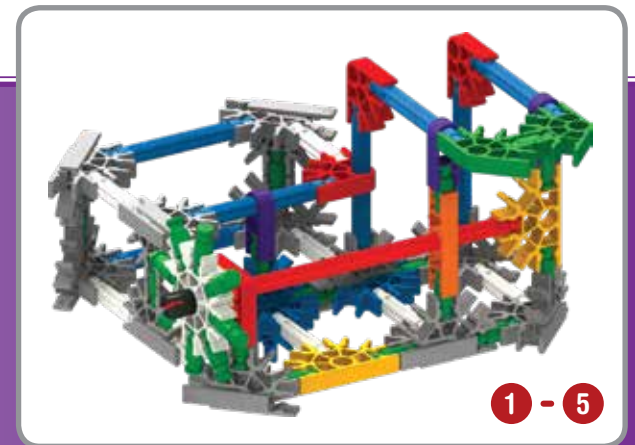
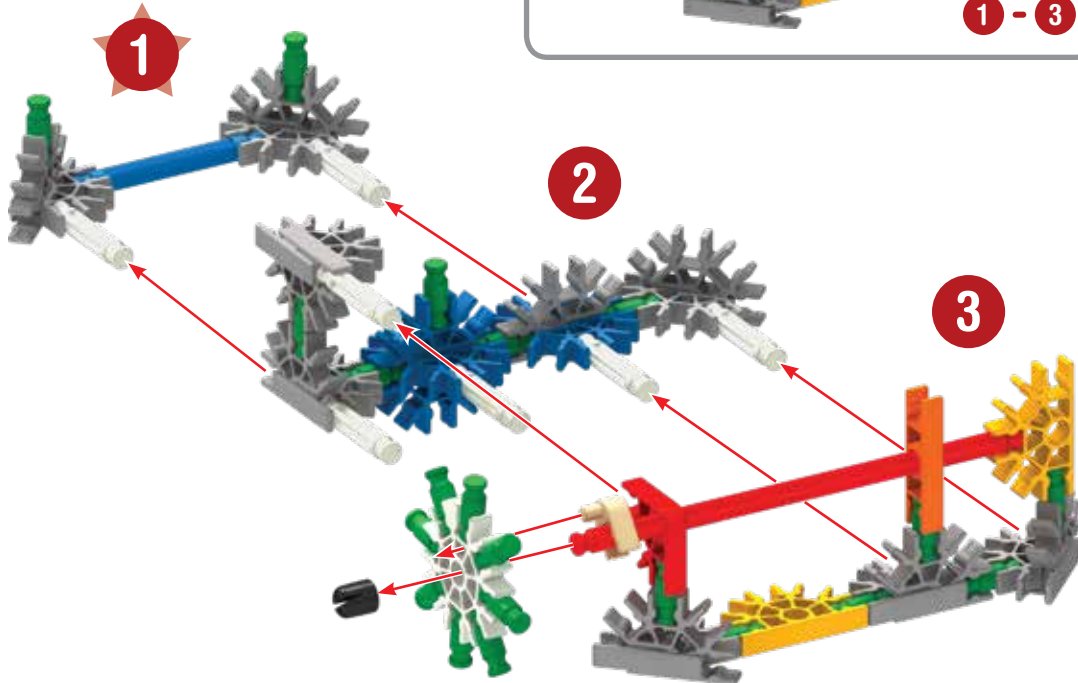
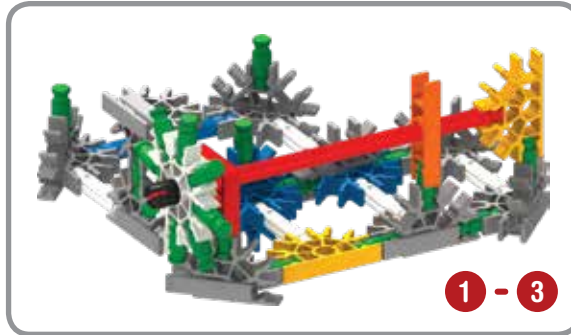
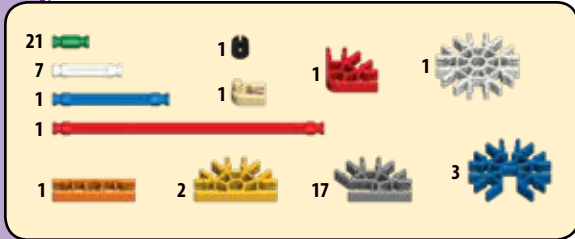
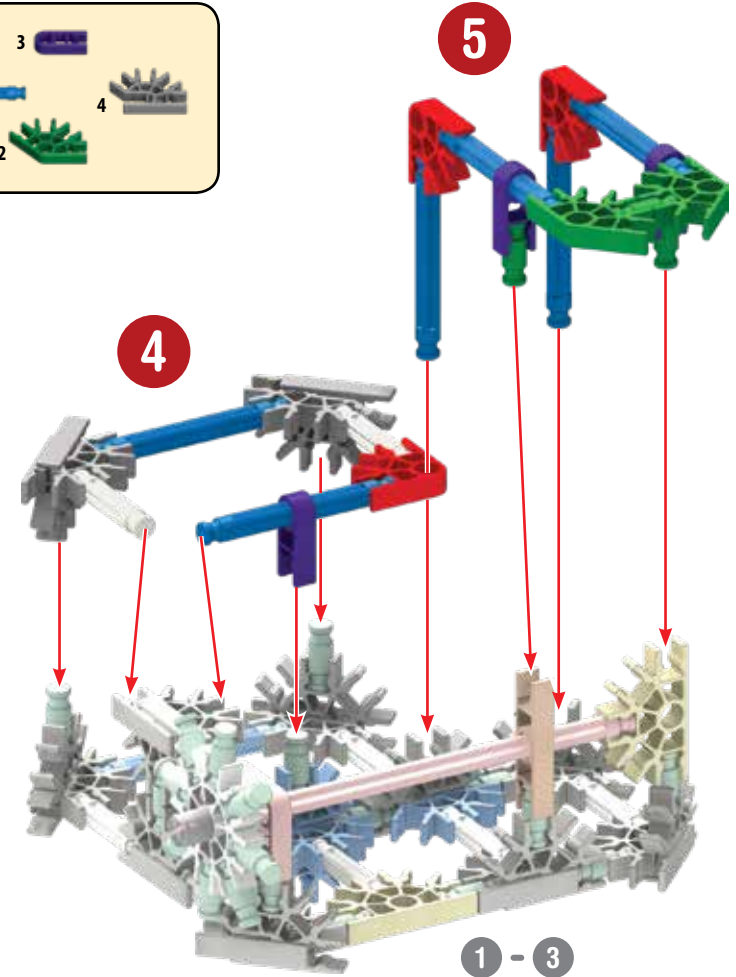
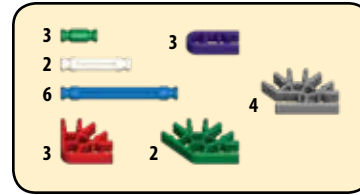

6

6

1	5	1
2		
2		

x6

7

7

6	12	
24		12
6		

12

7

7

7

7

7

8

6

6 - 8

1 - 9

9

1 - 5

6 - 8

11

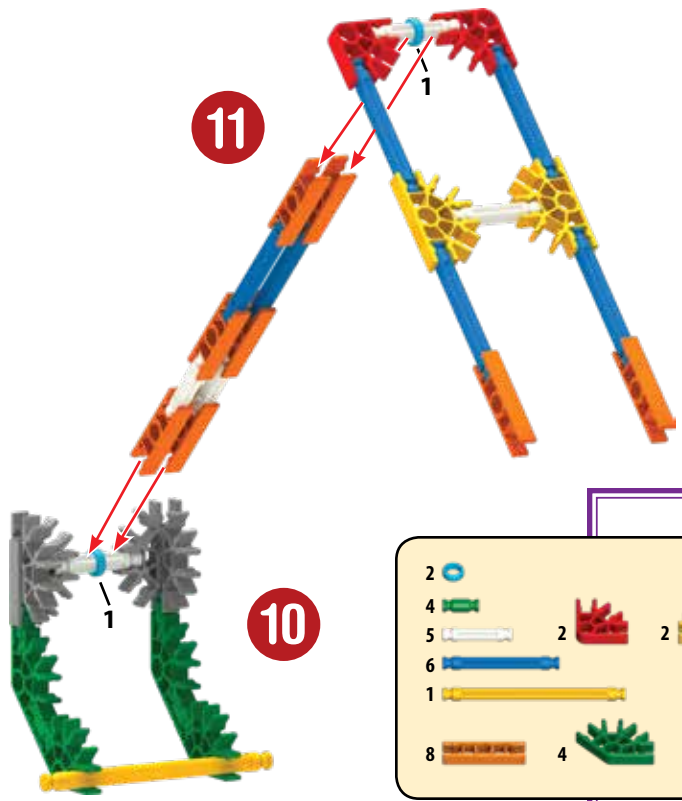

10

- | | | | | | |
|---|--|---|--|---|--|
| 2 | | | | | |
| 4 | | 2 | | 2 | |
| 5 | | | | | |
| 6 | | | | | |
| 1 | | | | | |
| 8 | | 4 | | 4 | |



1 - 12



10 - 11

12

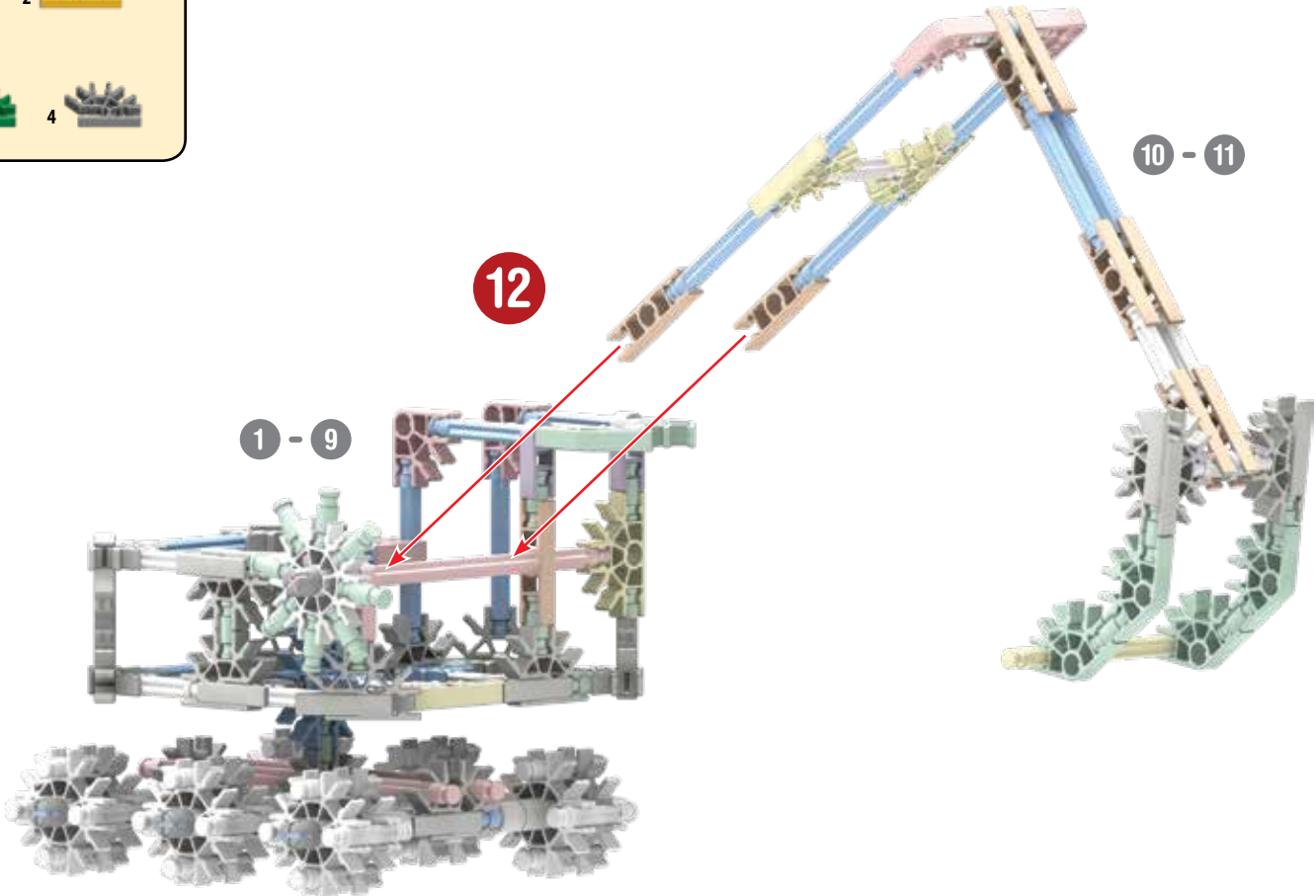

1 - 9

10 - 11

Space Shuttle

Navette Spatiale

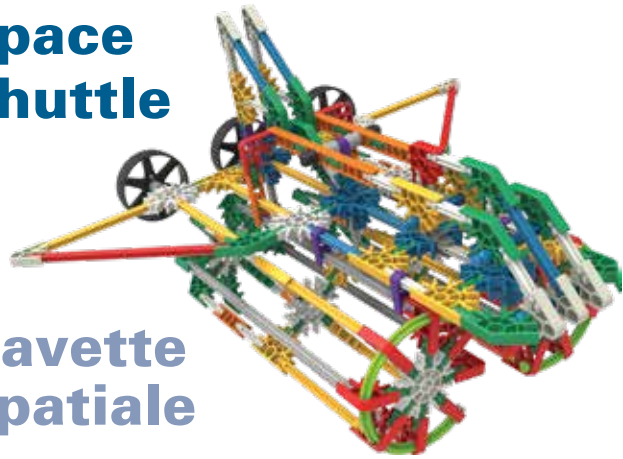

- | | |
|---|---|
| 2 | 3 |
| 5 | 8 |
| 5 | 1 |
| 6 | 2 |
| 2 | 6 |
| 6 | |

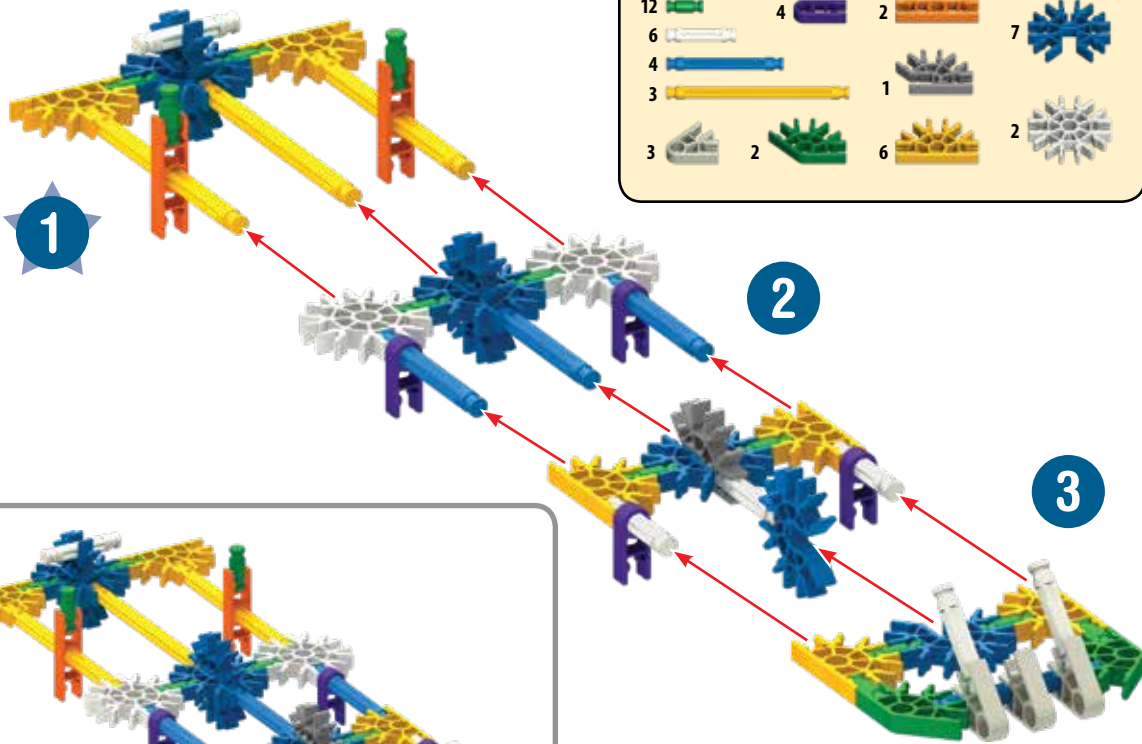
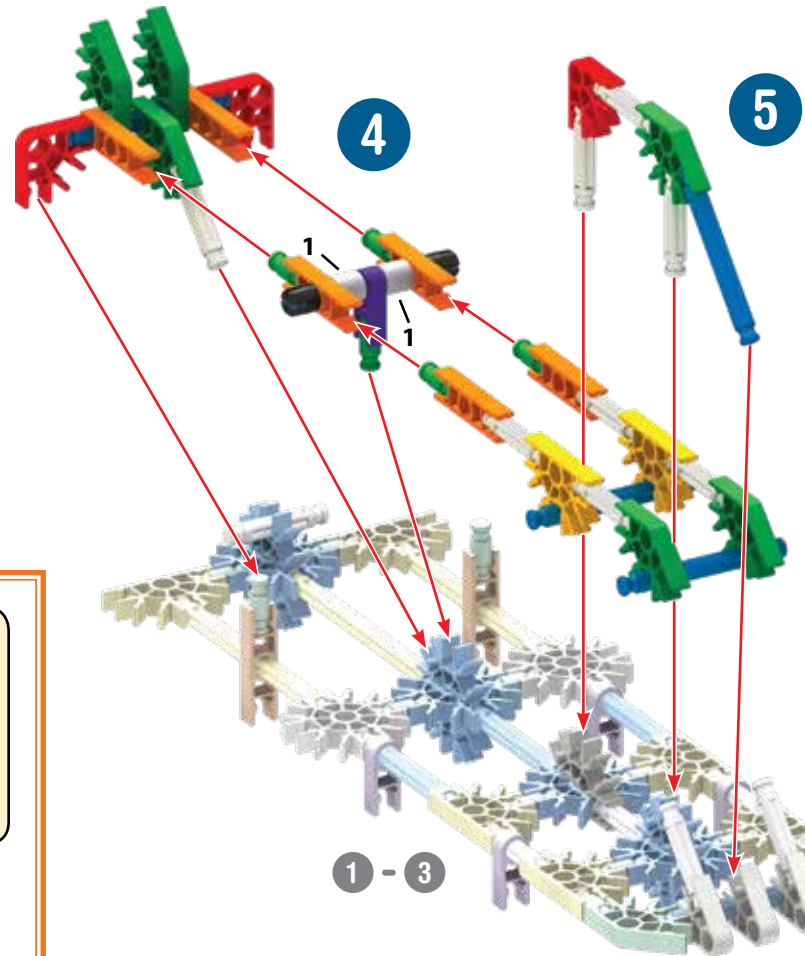

- | | | | |
|----|---|---|---|
| 12 | 4 | 2 | 7 |
| 6 | 4 | 1 | 3 |
| 3 | 2 | 6 | 2 |



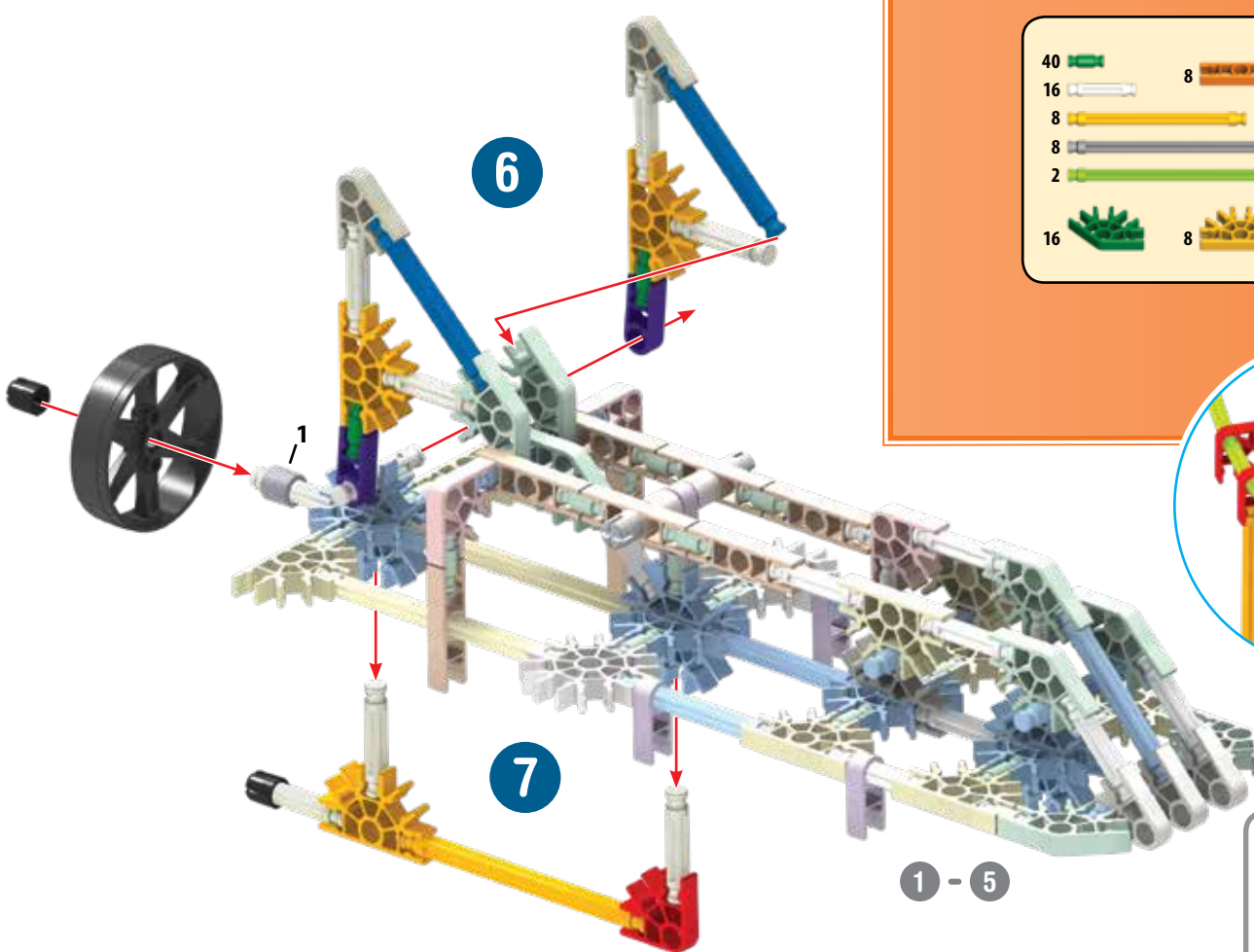

- | | | | | | |
|----|--|---|--|----|--|
| 40 | | 8 | | 16 | |
| 16 | | | | | |
| 8 | | | | | |
| 8 | | | | | |
| 2 | | | | | |
| 16 | | 8 | | 6 | |

x2

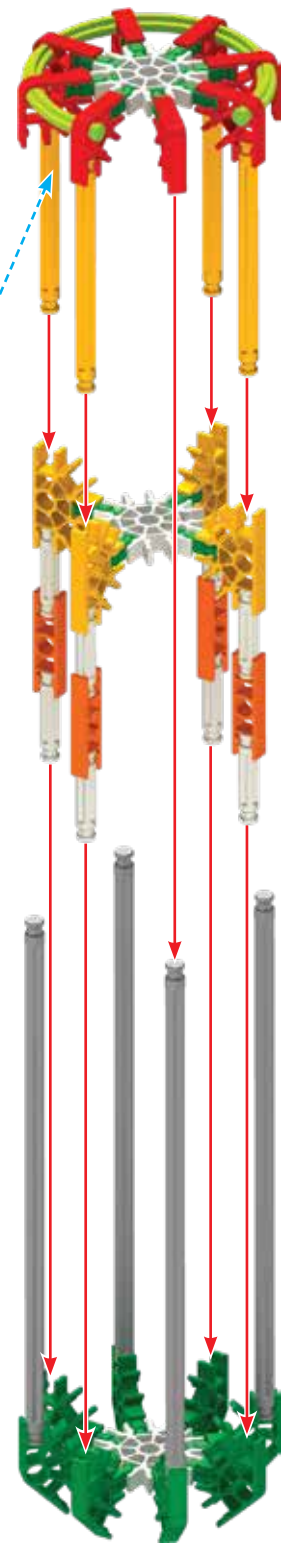

- | | | | |
|---|--|---|--|
| 2 | | 2 | |
| 8 | | | |
| 2 | | 1 | |
| 1 | | | |
| 2 | | 2 | |
| 1 | | 3 | |
| 1 | | | |

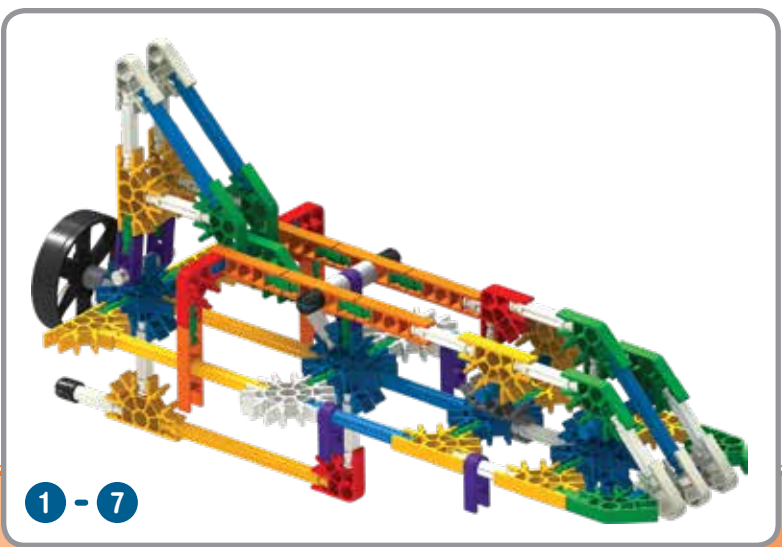

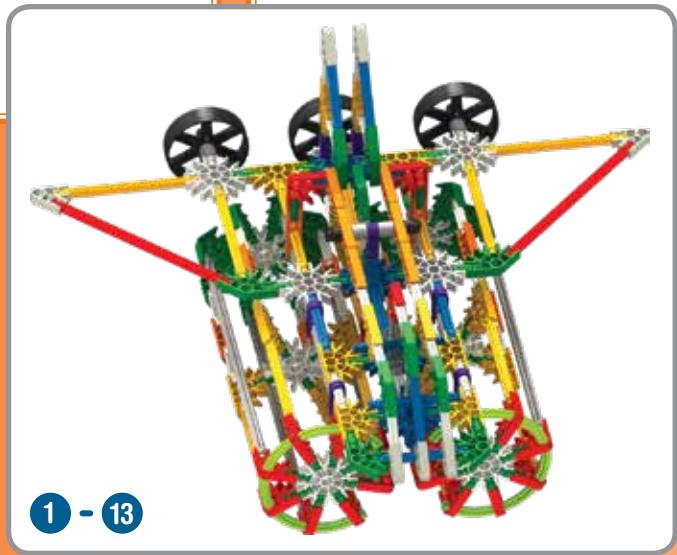
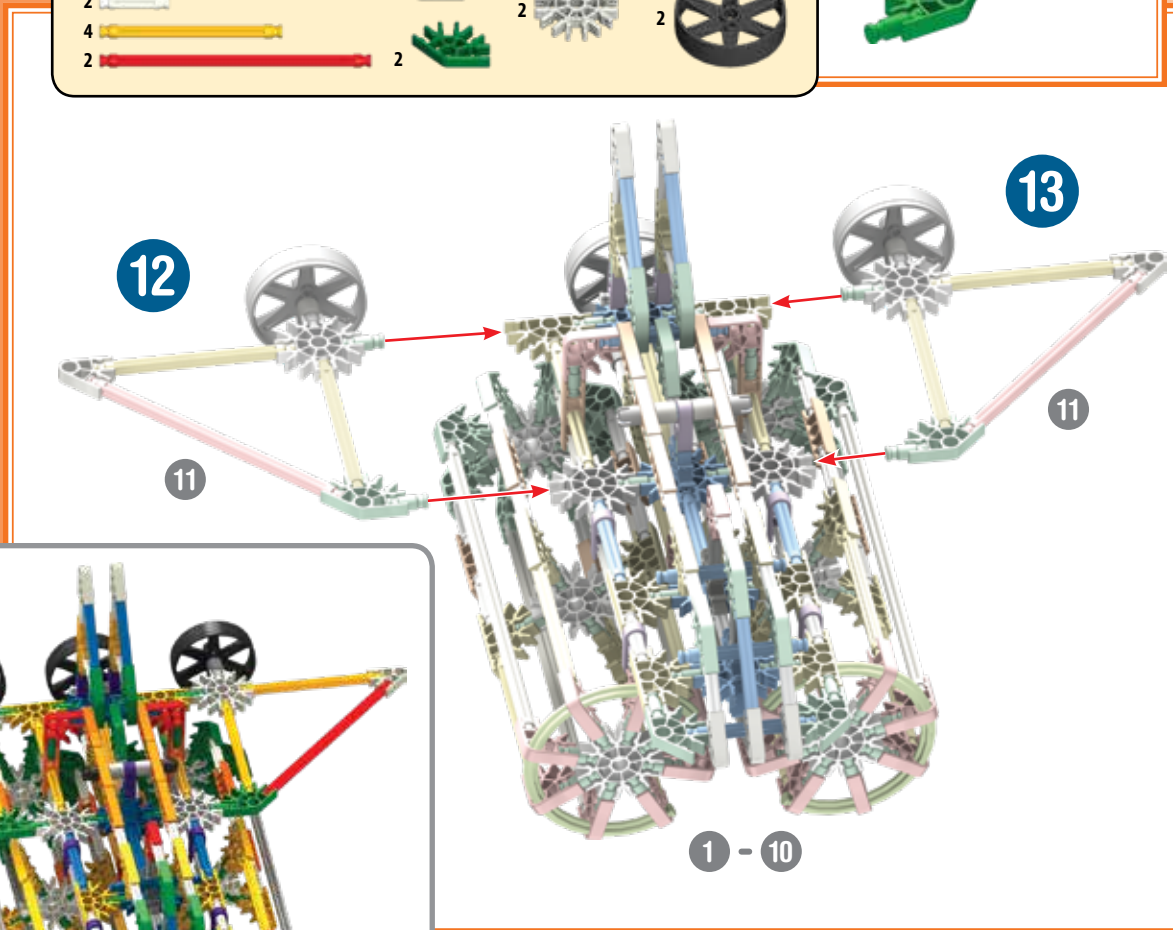
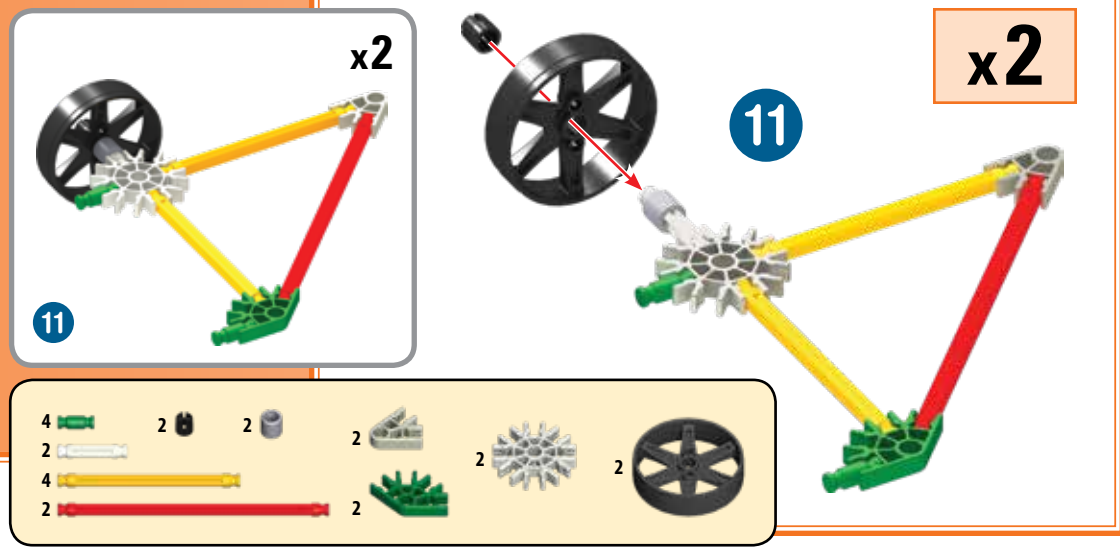
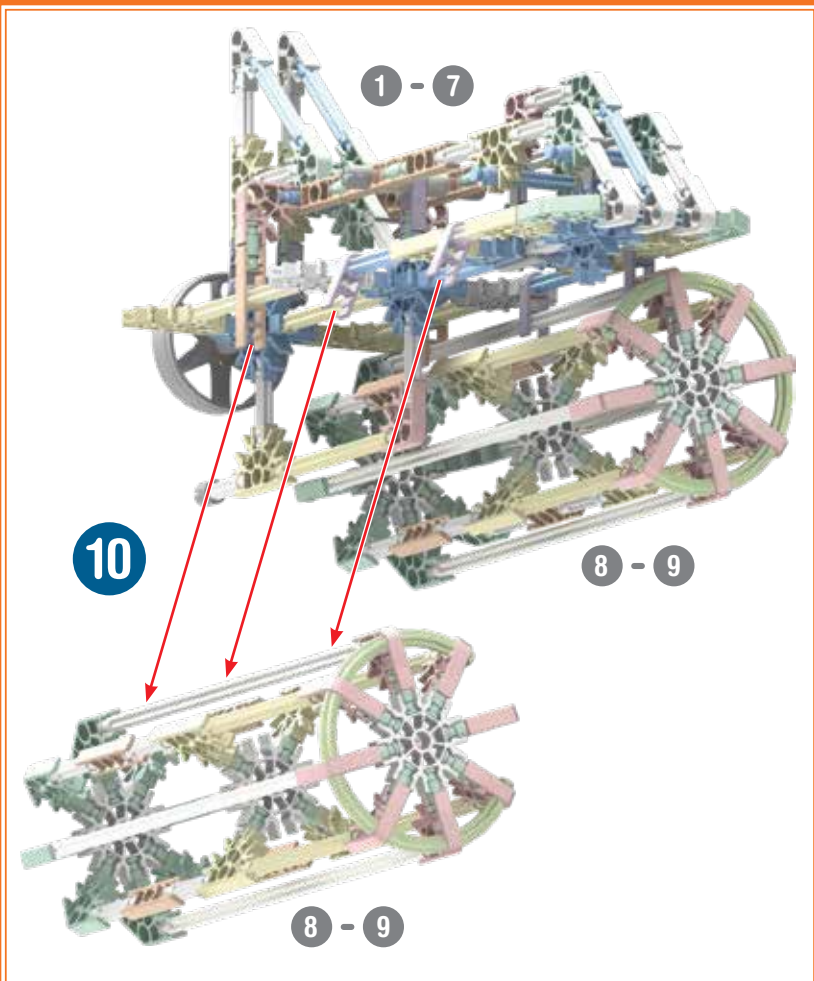

Eiffel Tower

La Tour Eiffel

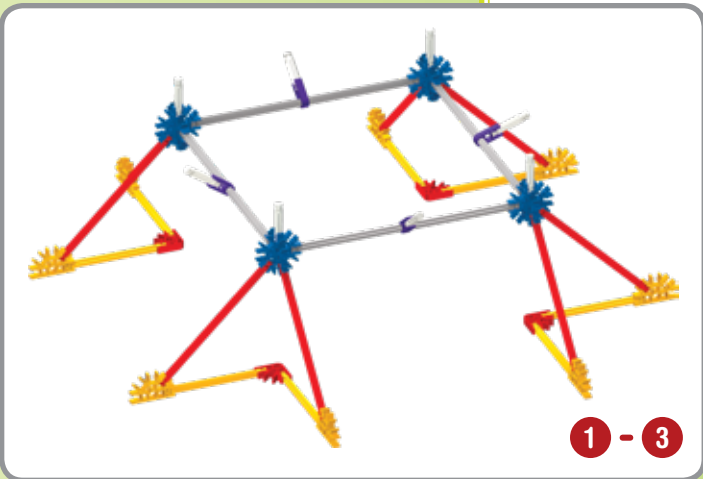
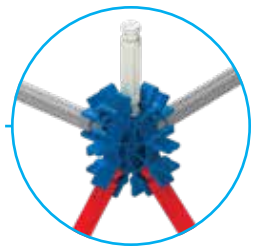
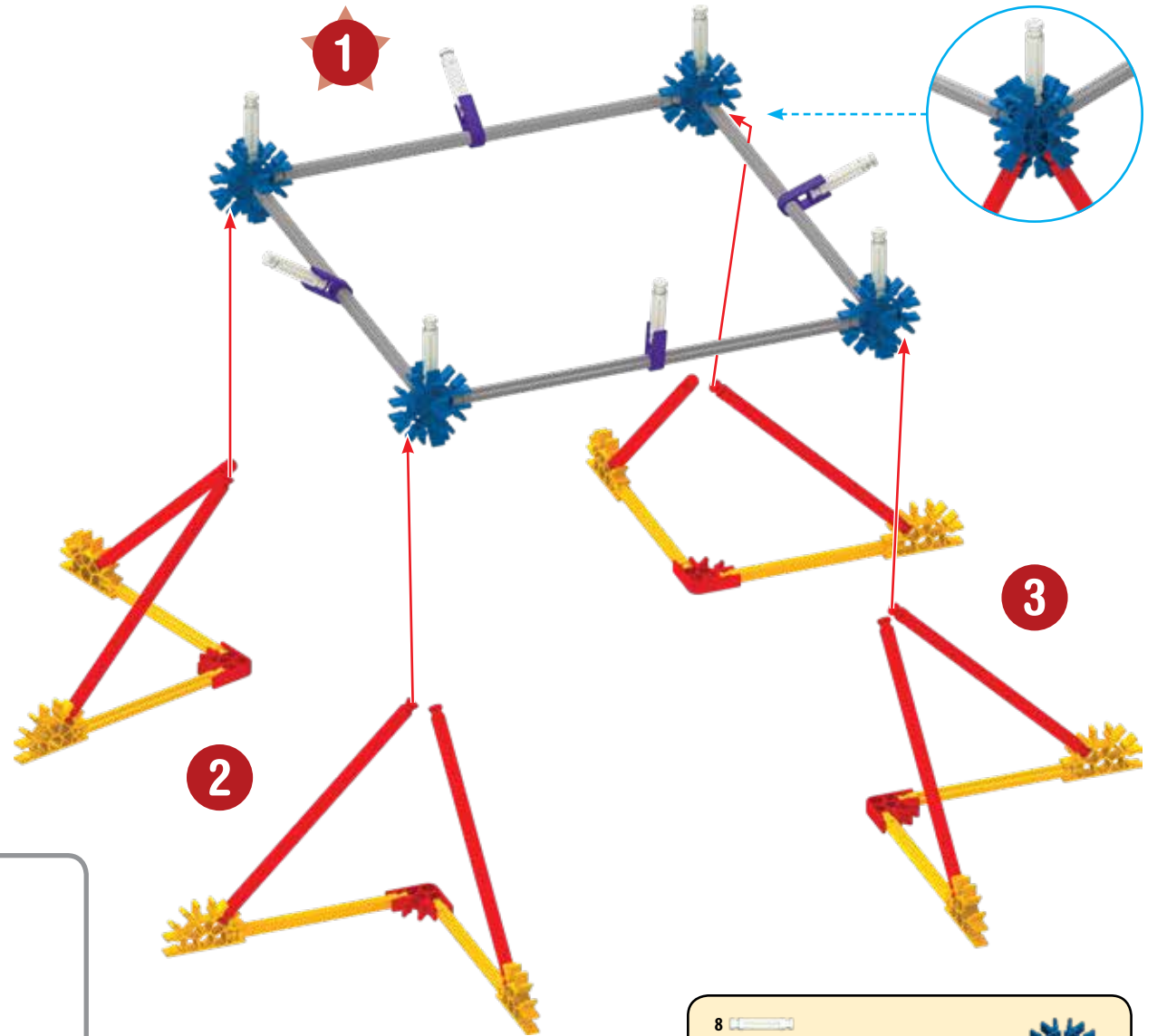

- 8
- 8
- 8
- 4
- 4
- 4
- 8
- 8

1 - 3

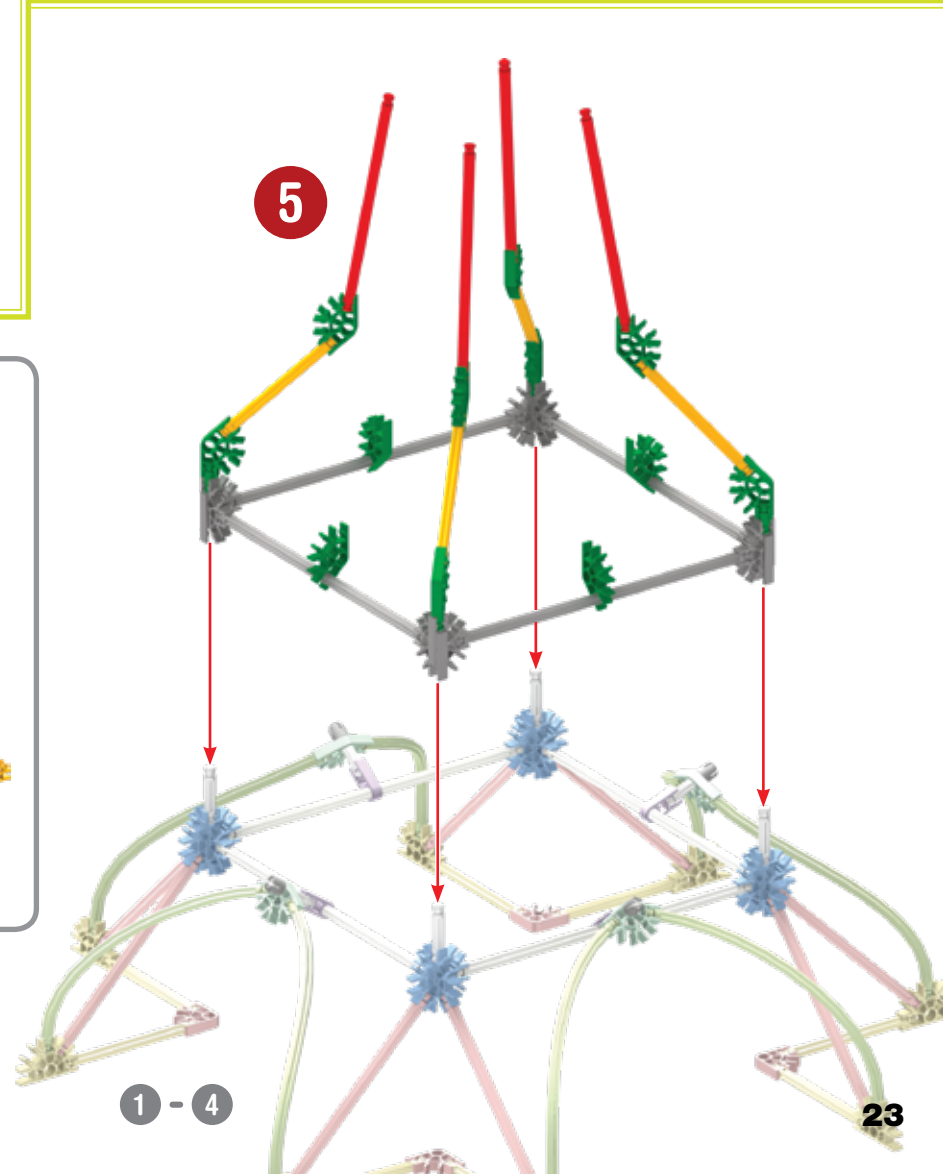
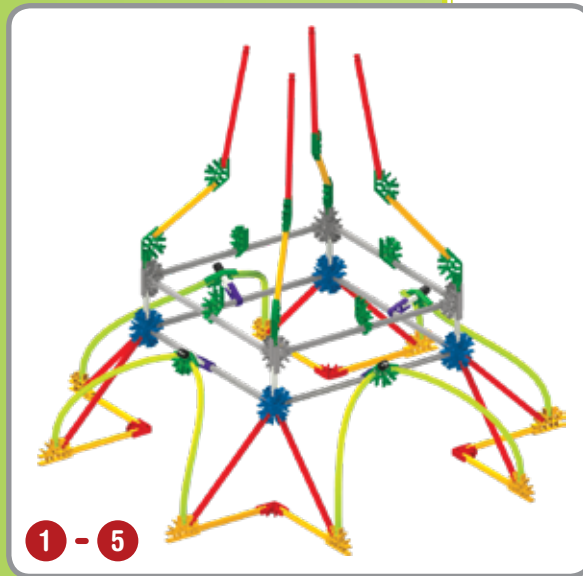
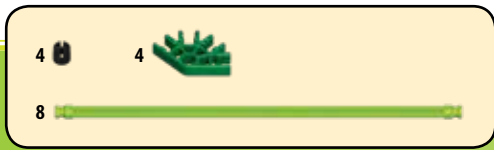
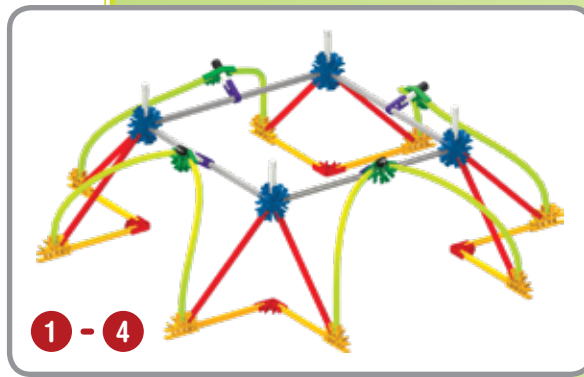
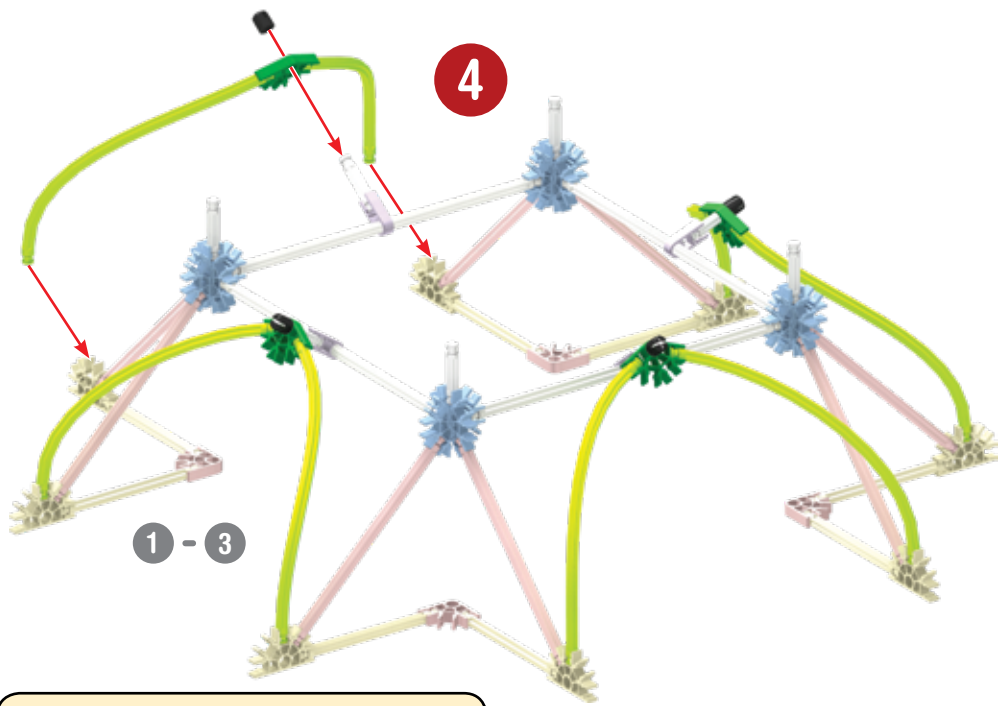

6

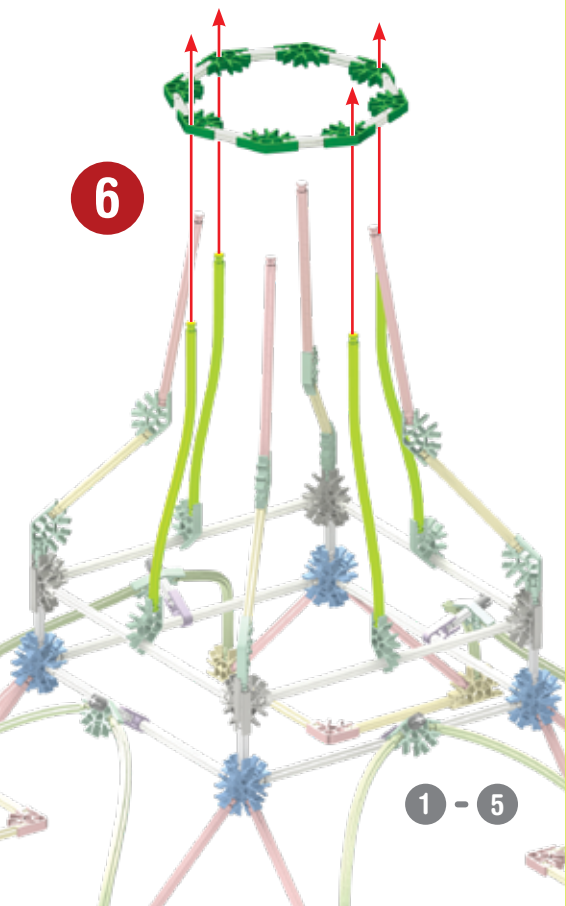

1 - 5

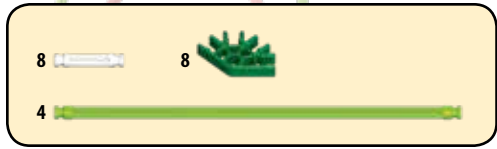

7

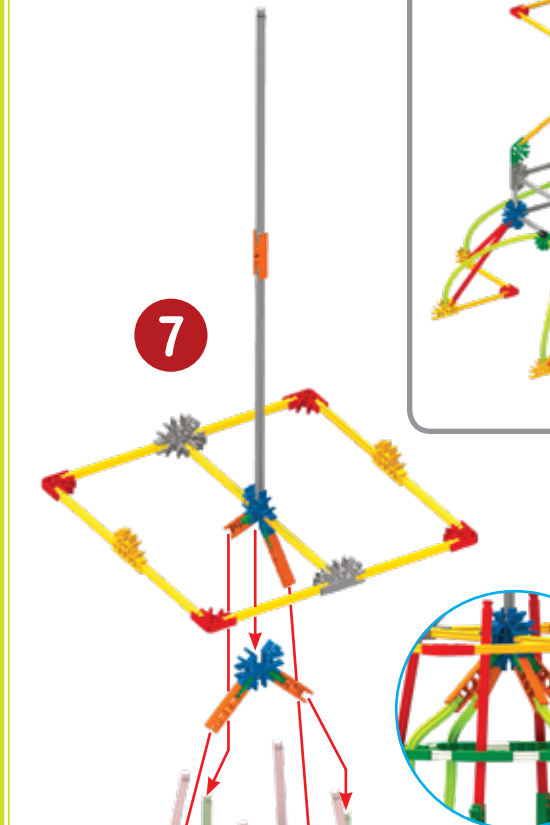

1 - 6

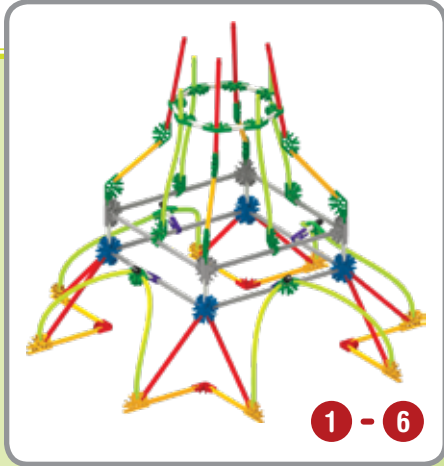

1 - 6

8

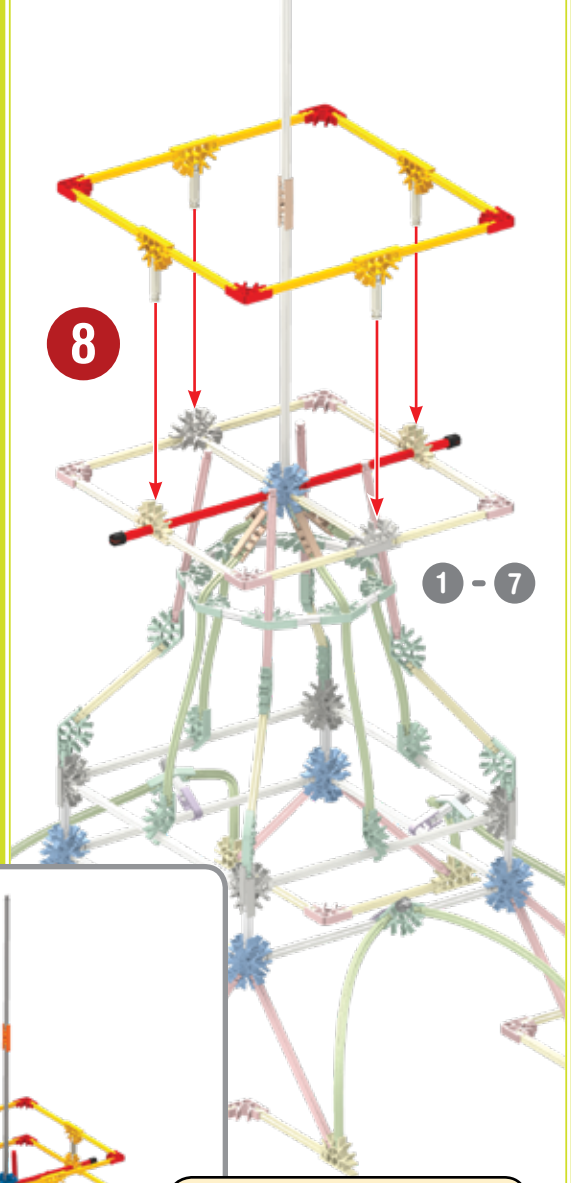

1 - 7

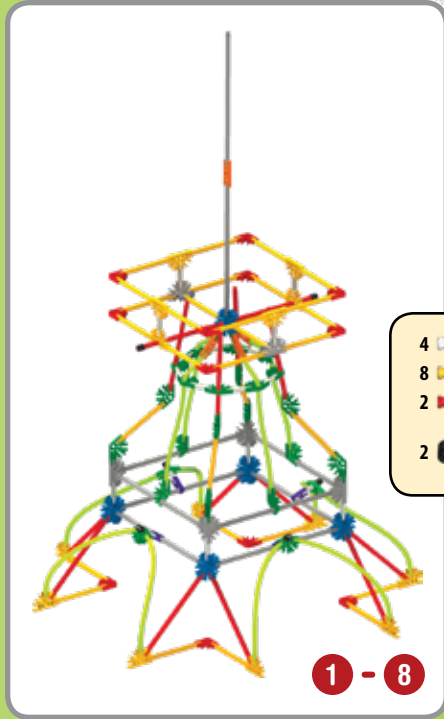

1 - 8

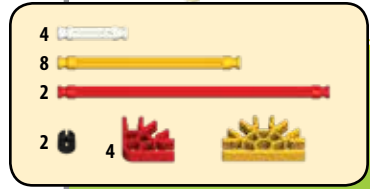

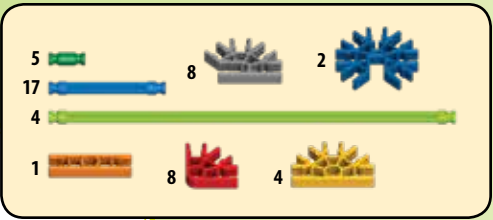

10

9

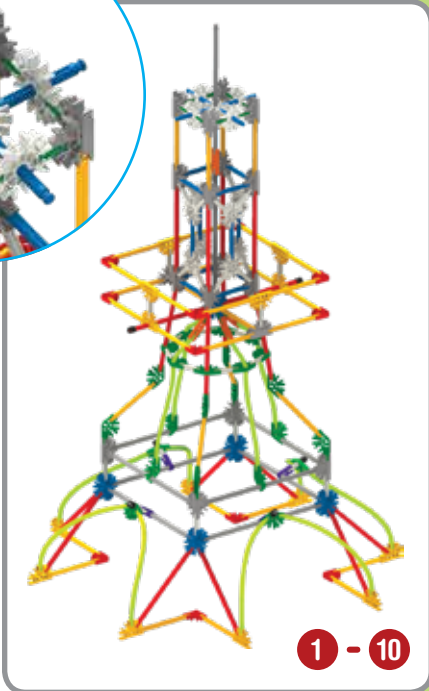

1 - 10

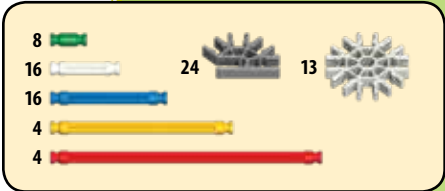

12

11

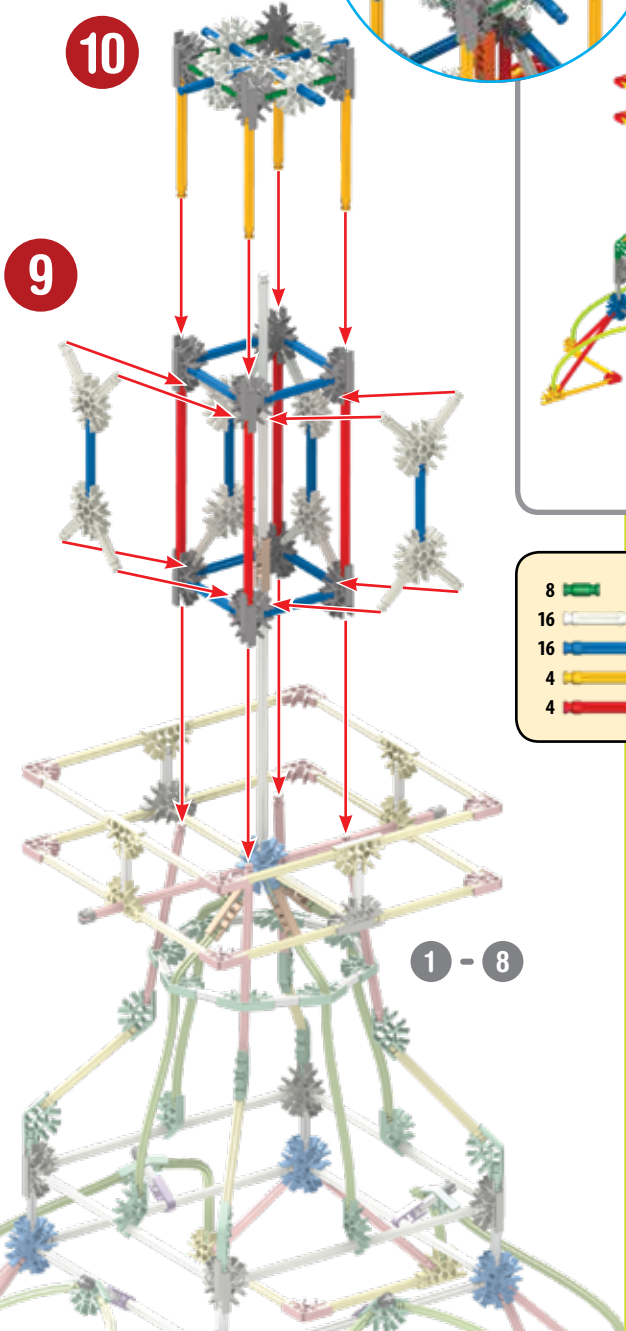

1 - 8

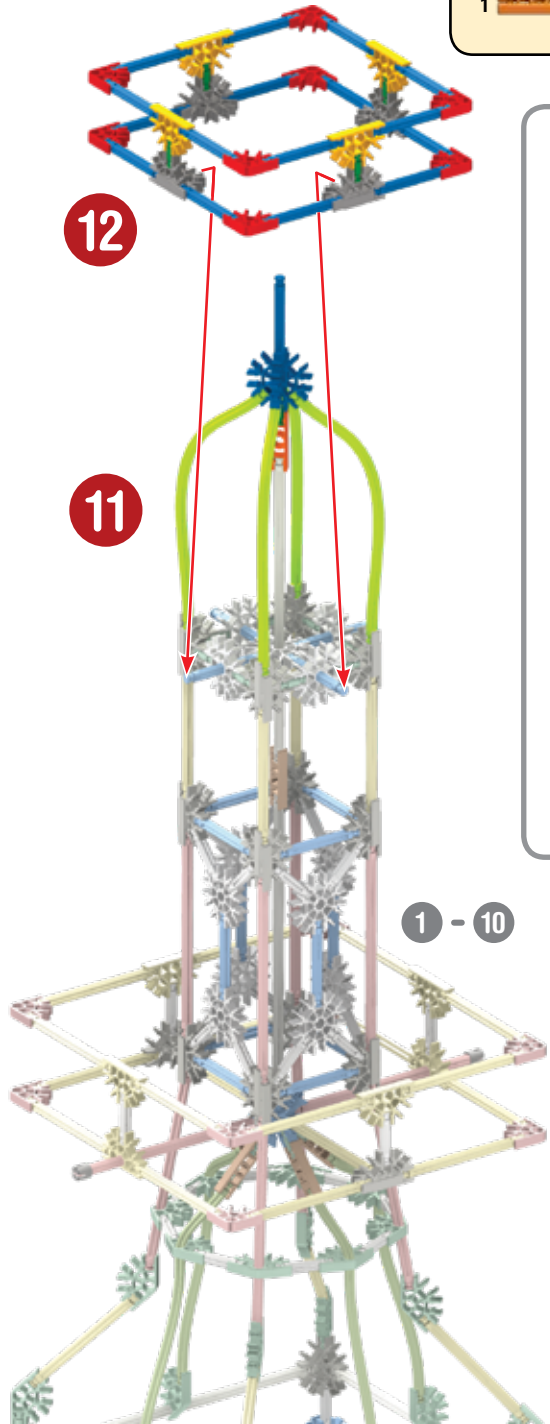

1 - 10

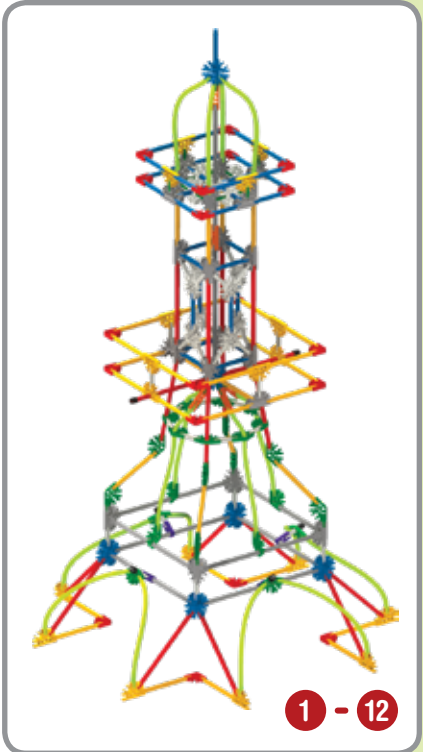

1 - 12

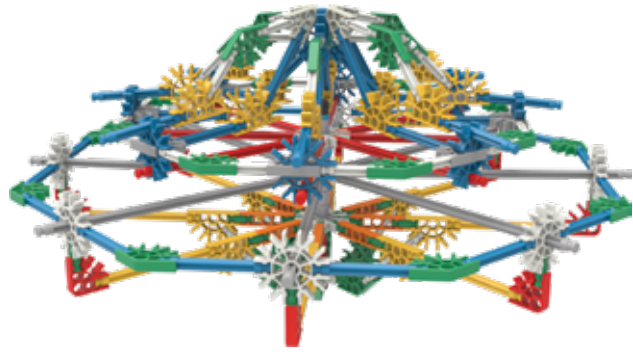

Flying Saucer
Disc Volant
Non Identifié

x8

1

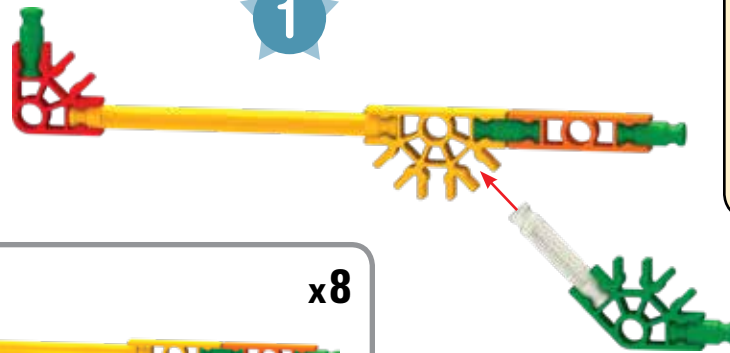

- 32
- 8
- 8
- 8
- 8
- 8

x8

1

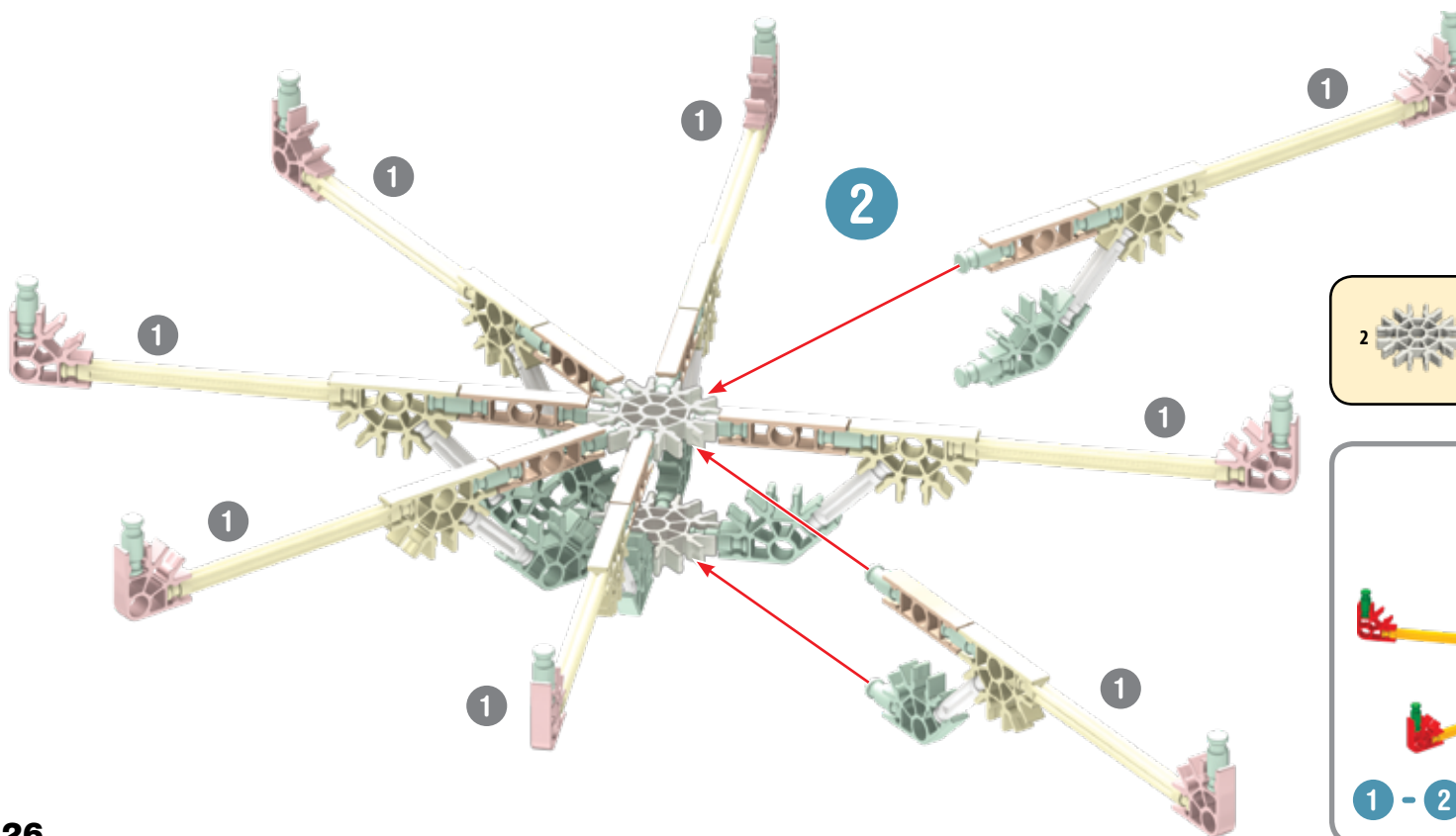
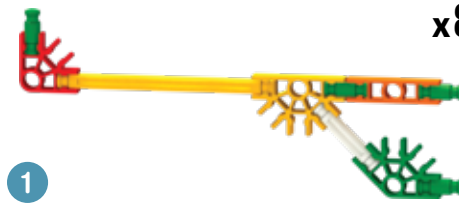

2

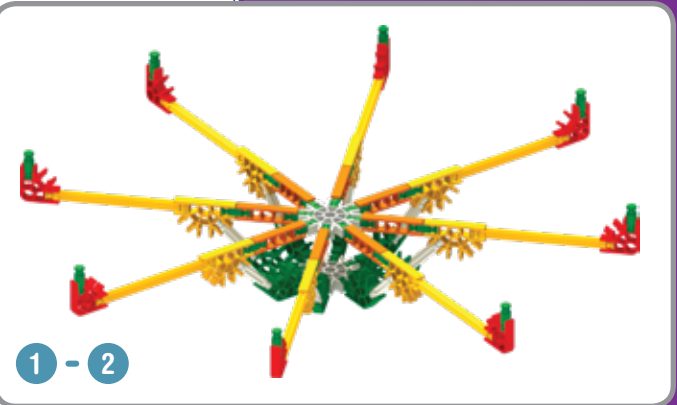
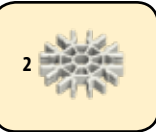

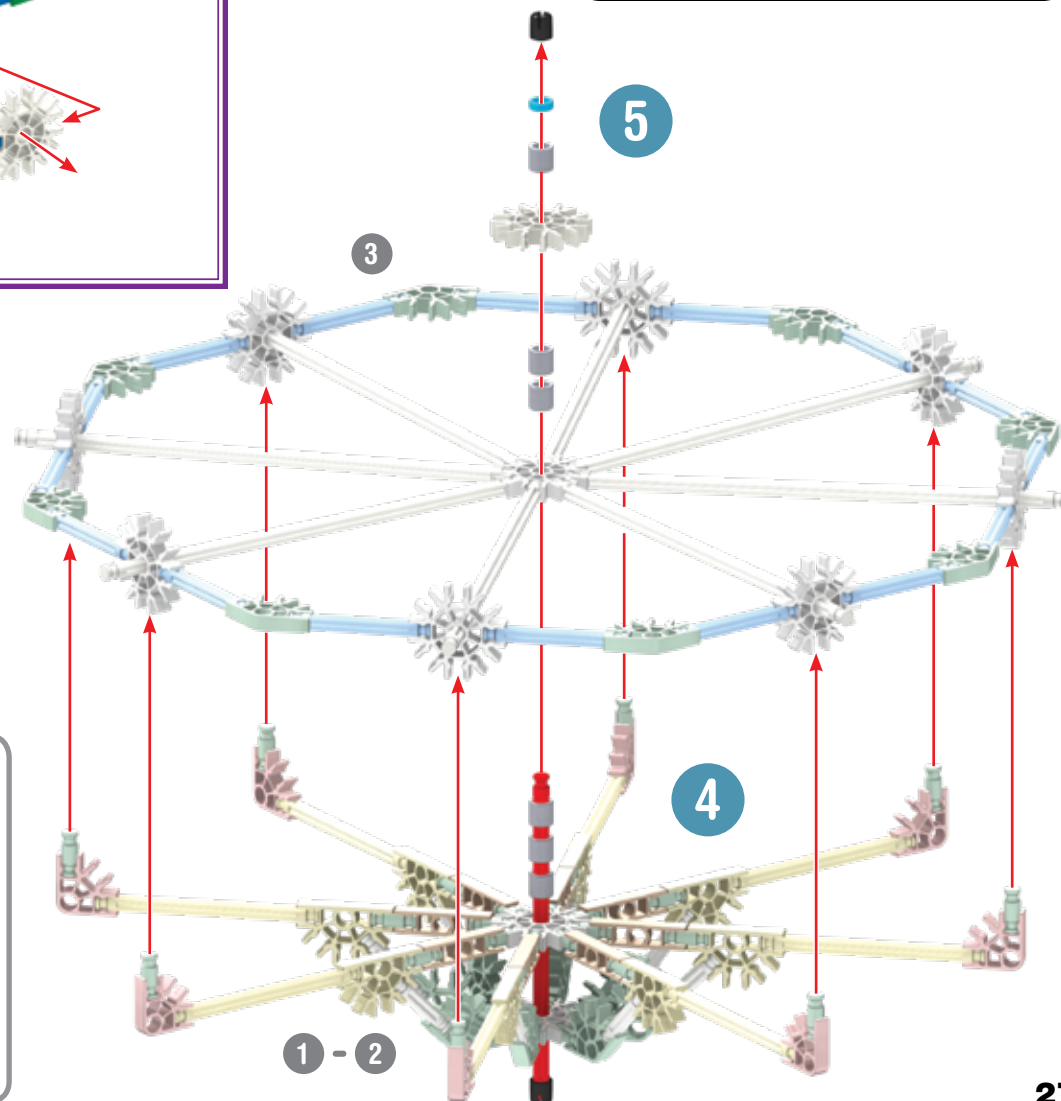
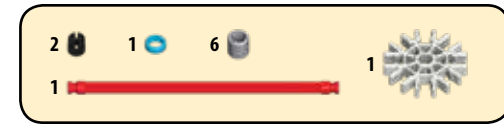
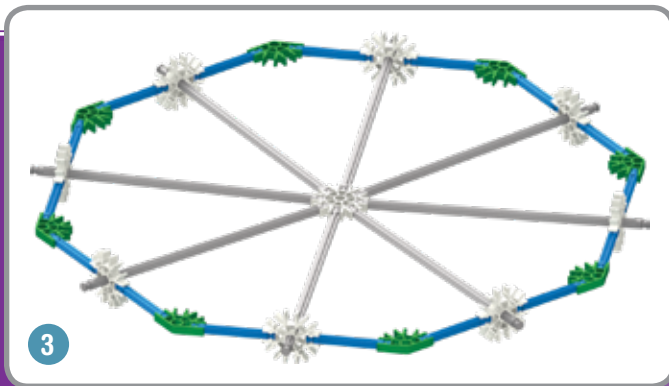
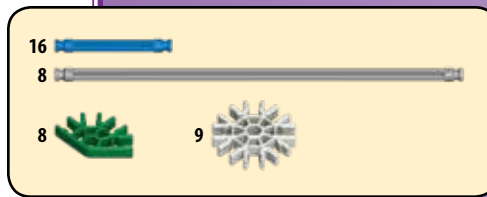
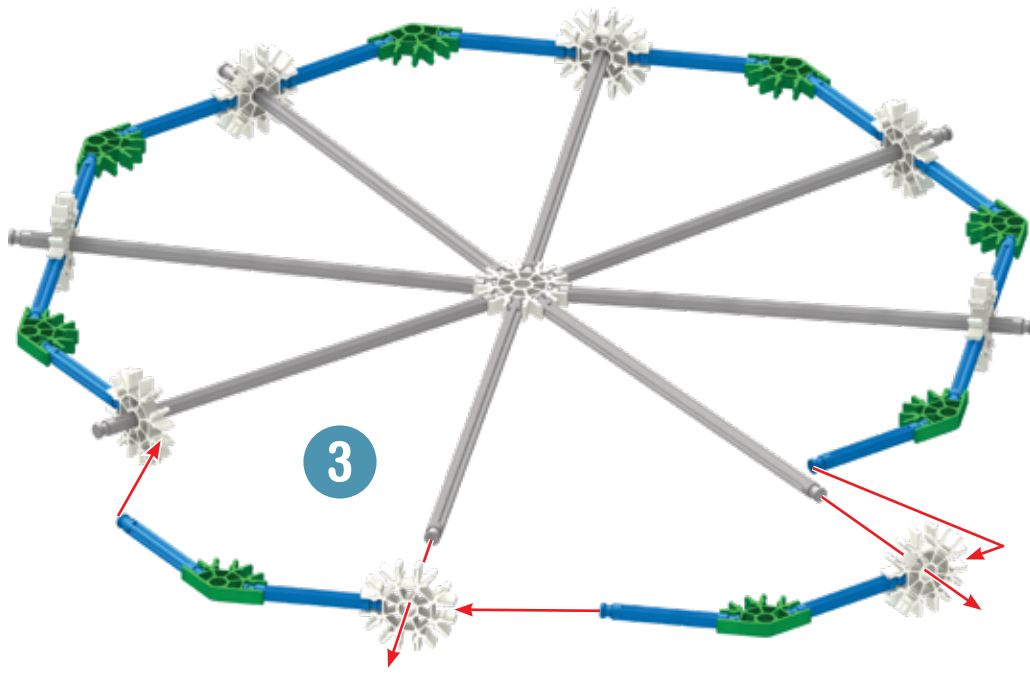

x4

6

16		8	
12		4	
12		4	

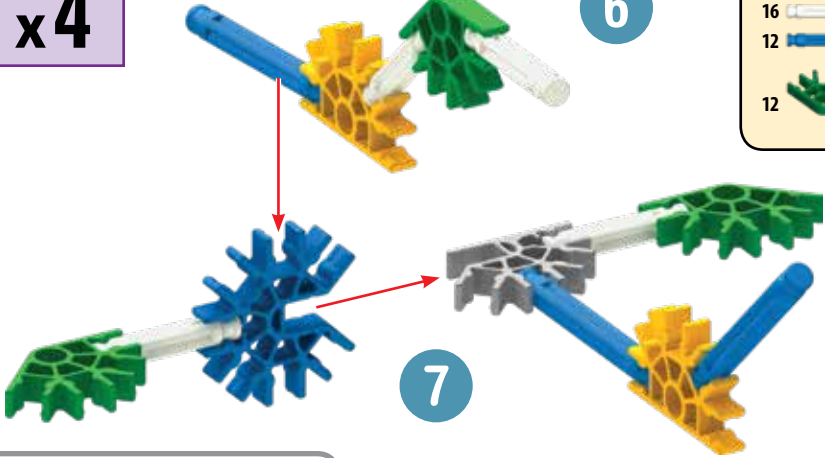

7

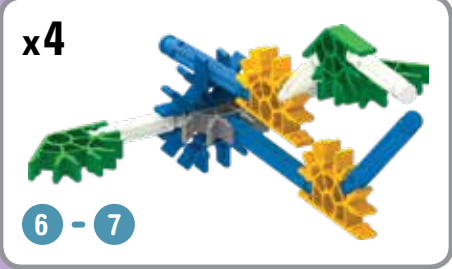

x4

6 - 7

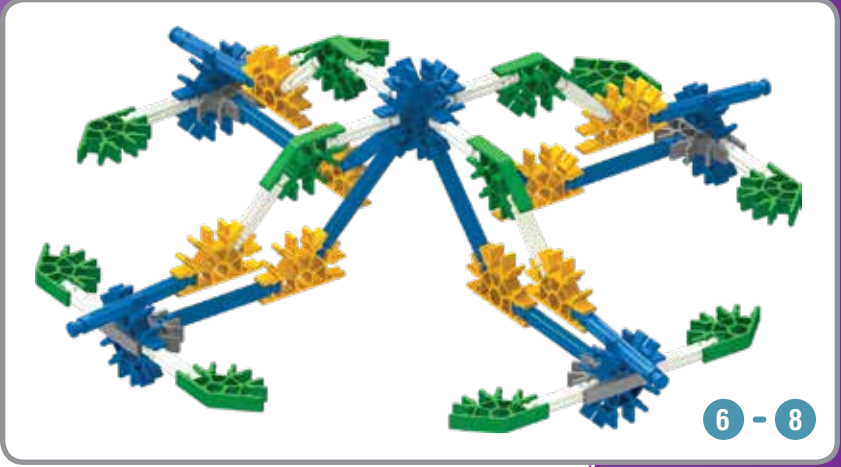

6 - 8

2

8

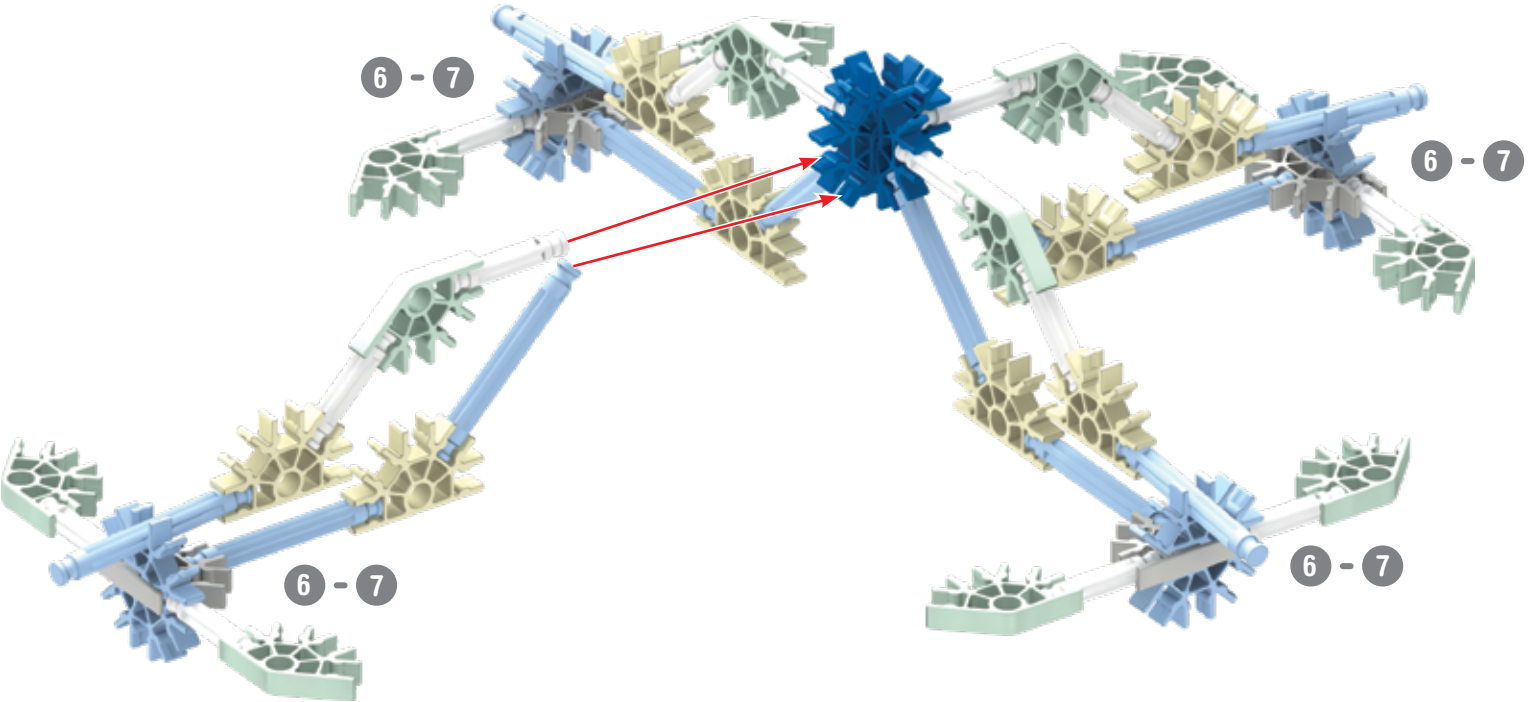

6 - 7

6 - 7

6 - 7

6 - 7

x4

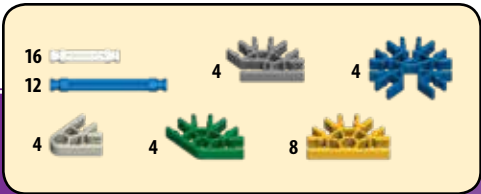
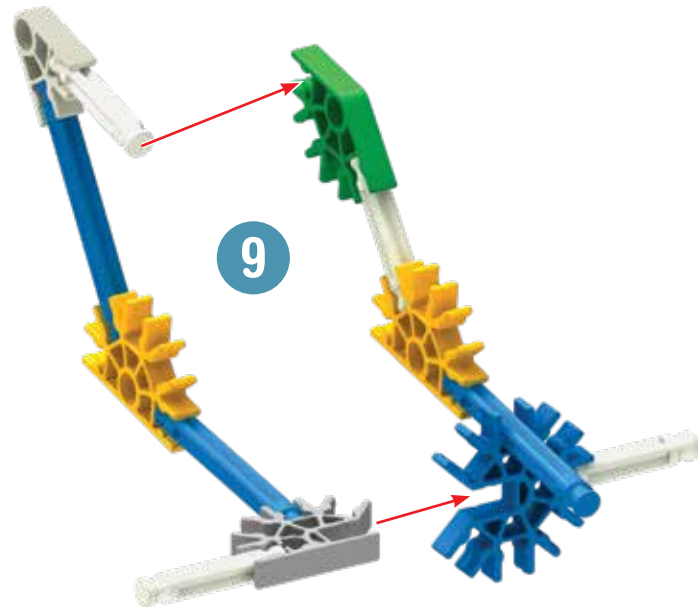

10

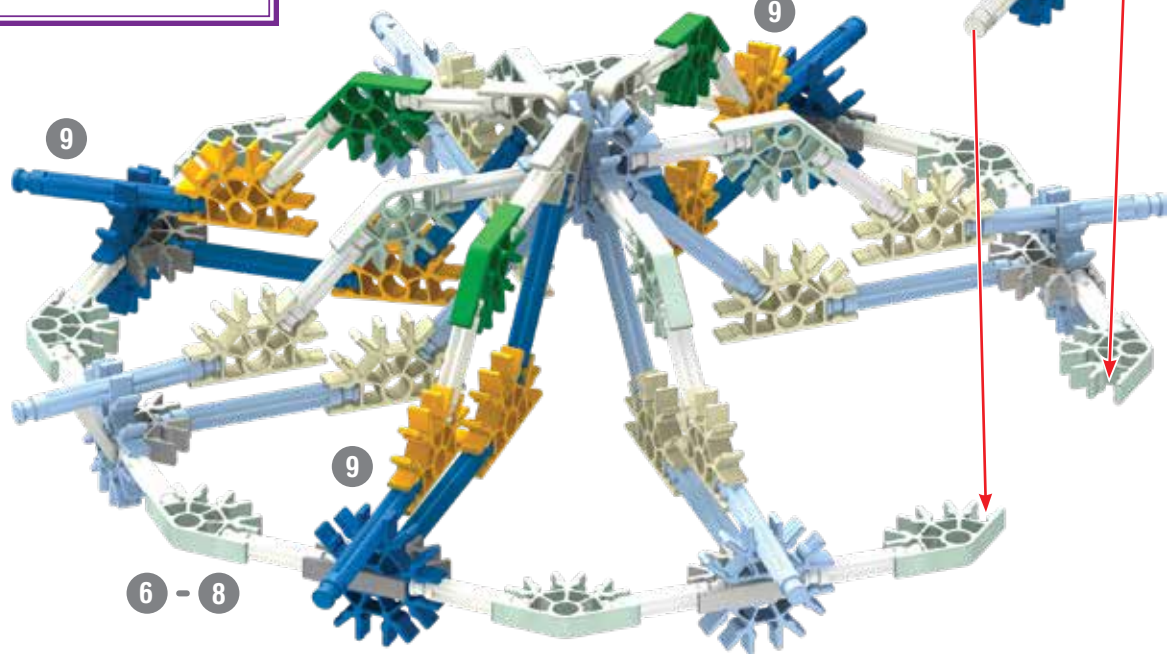
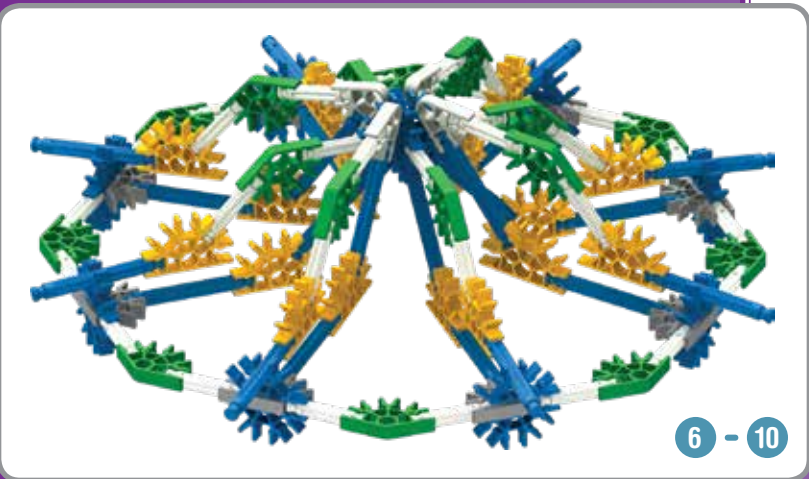
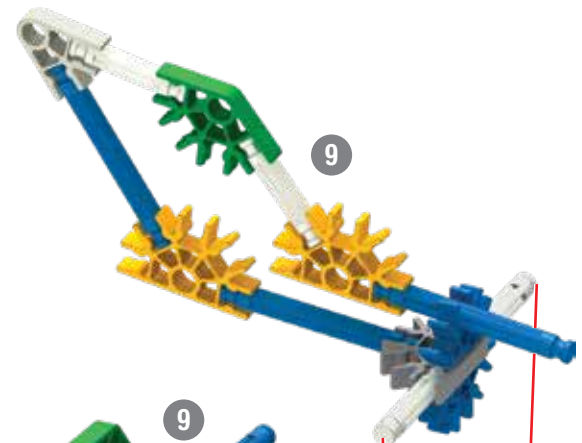

6 - 10

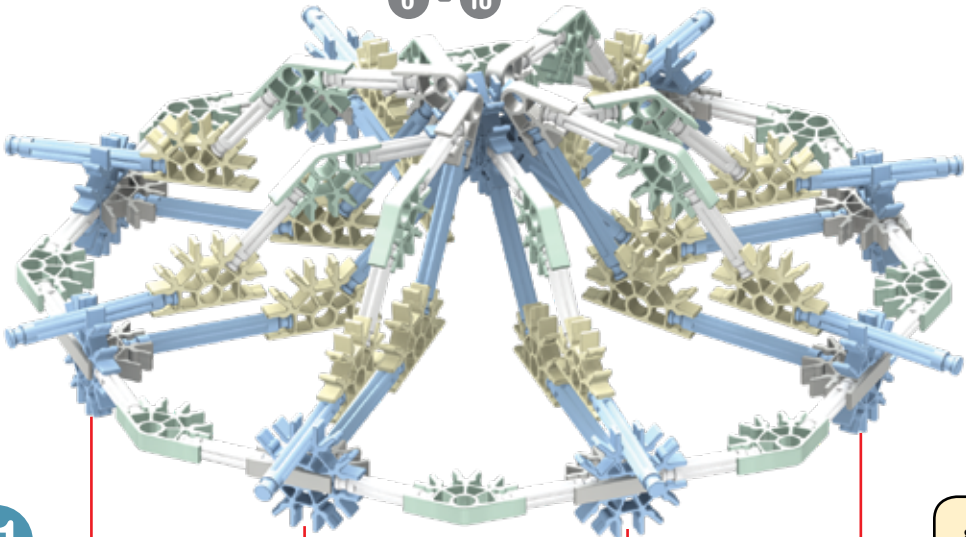

11

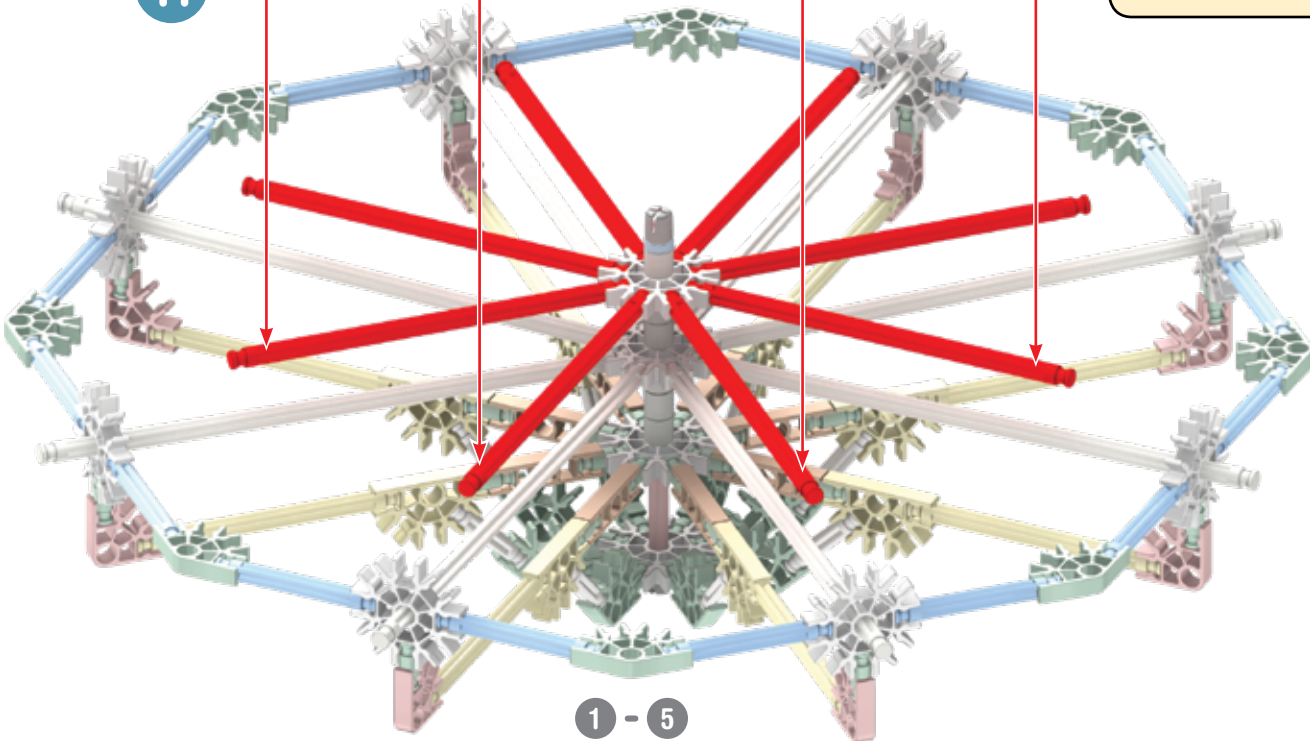

1 - 5



1 - 11

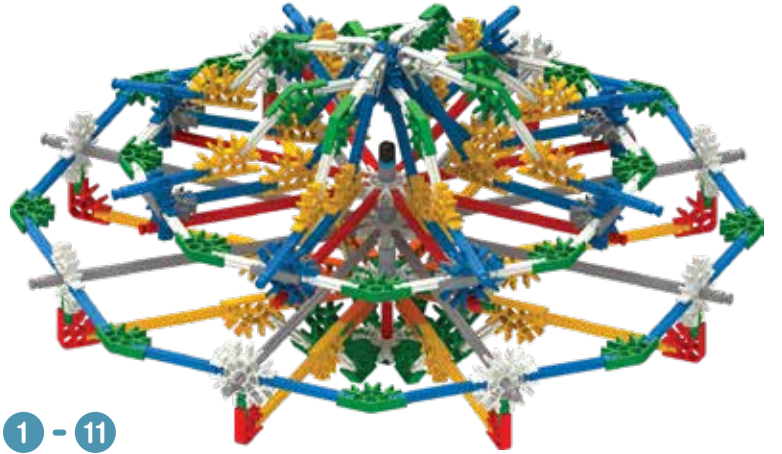

Pod Spinner Pod Tournant

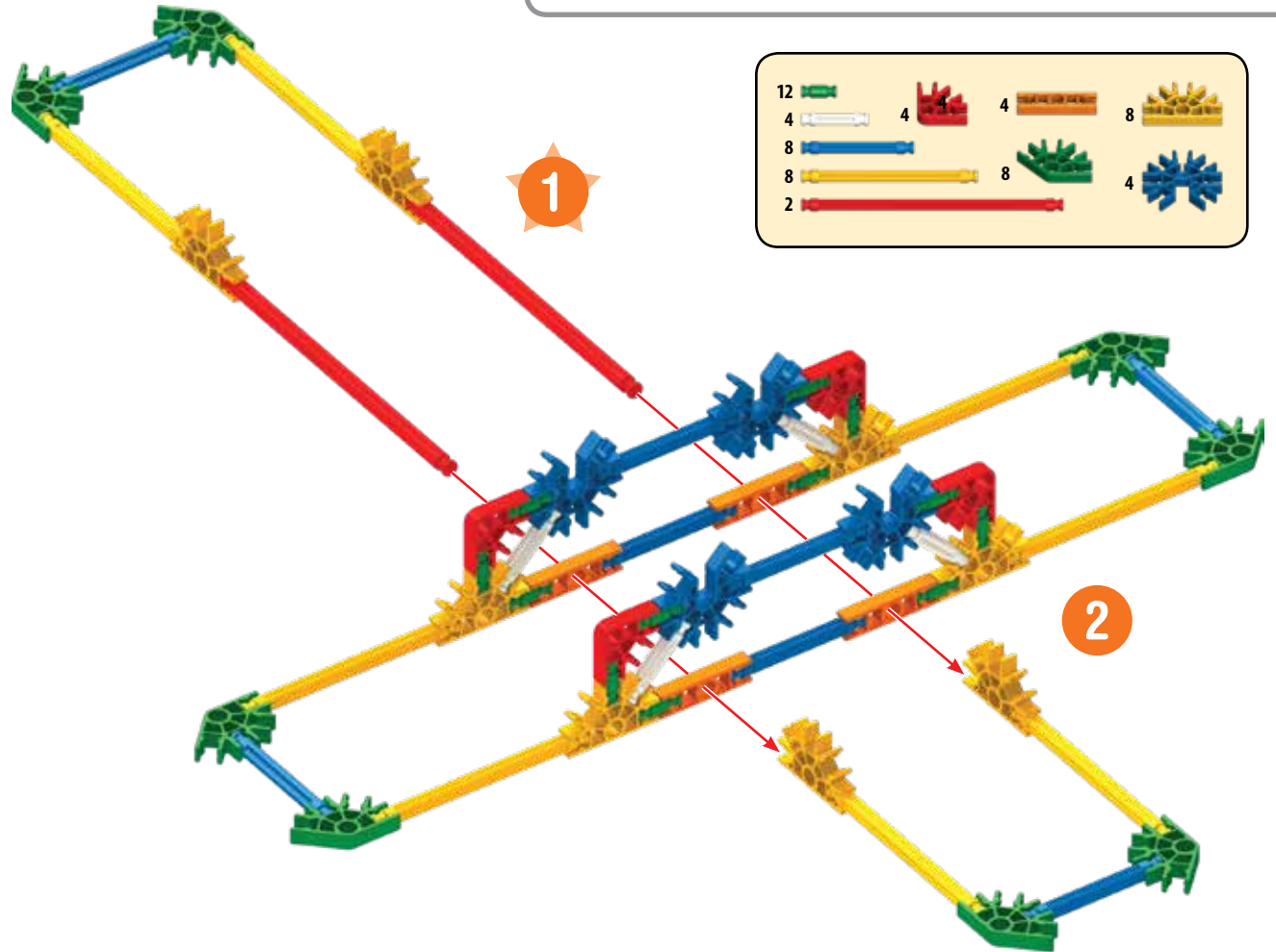
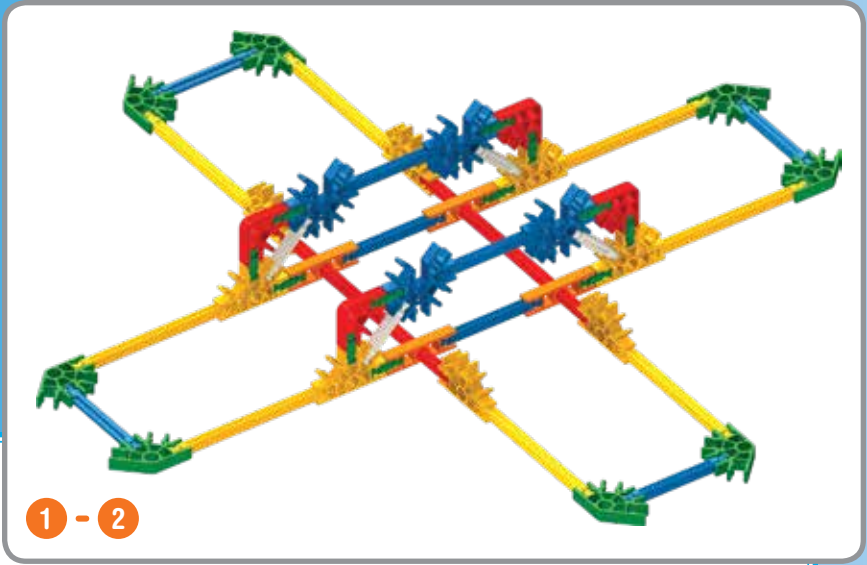

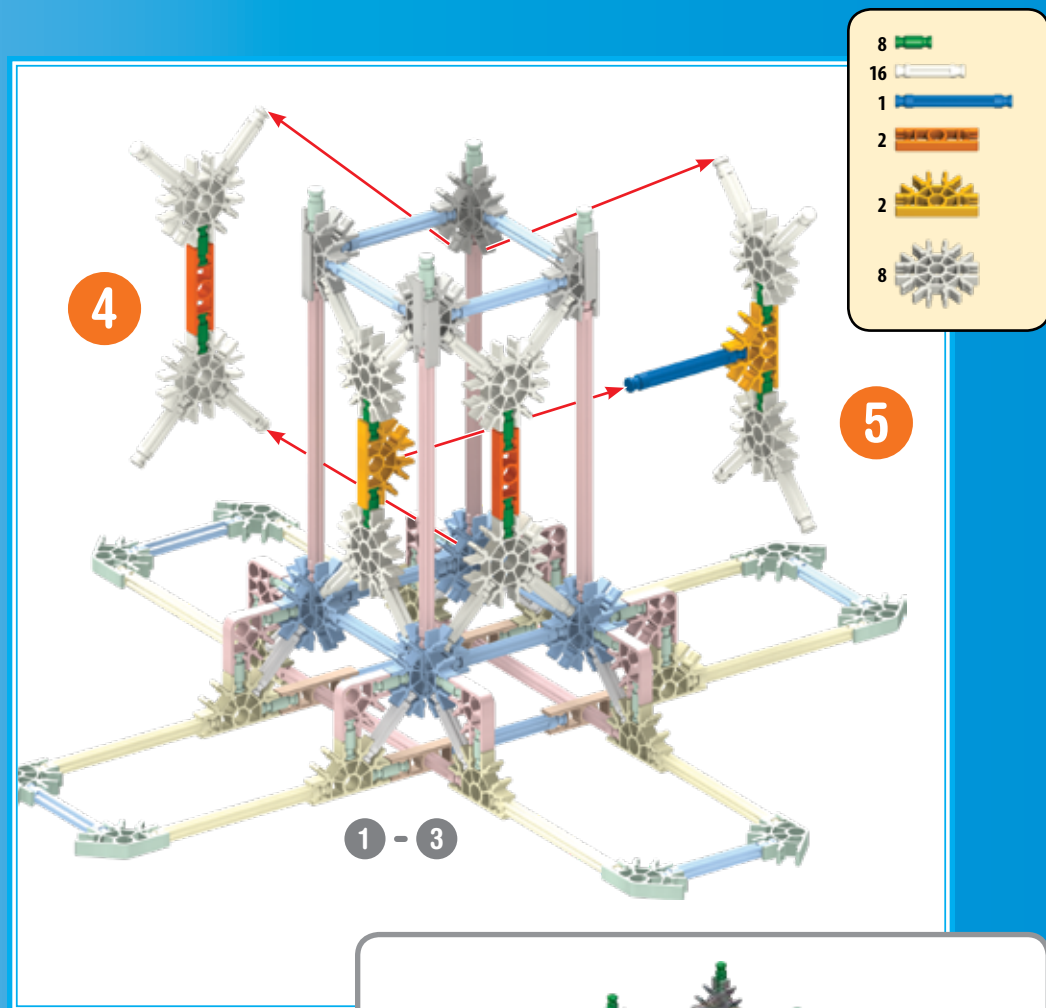
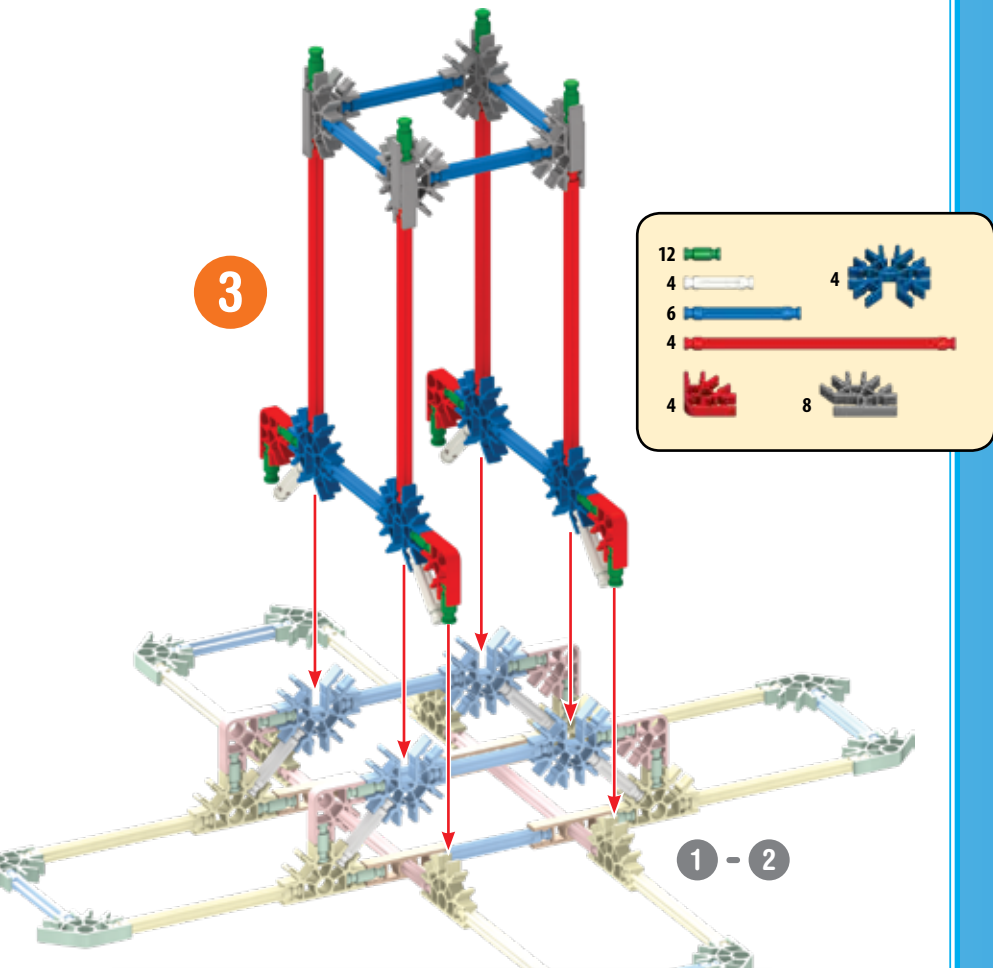

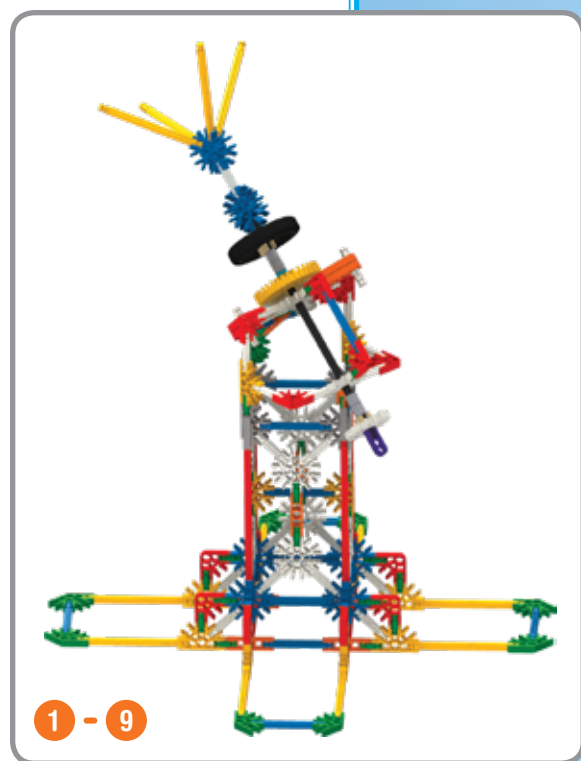
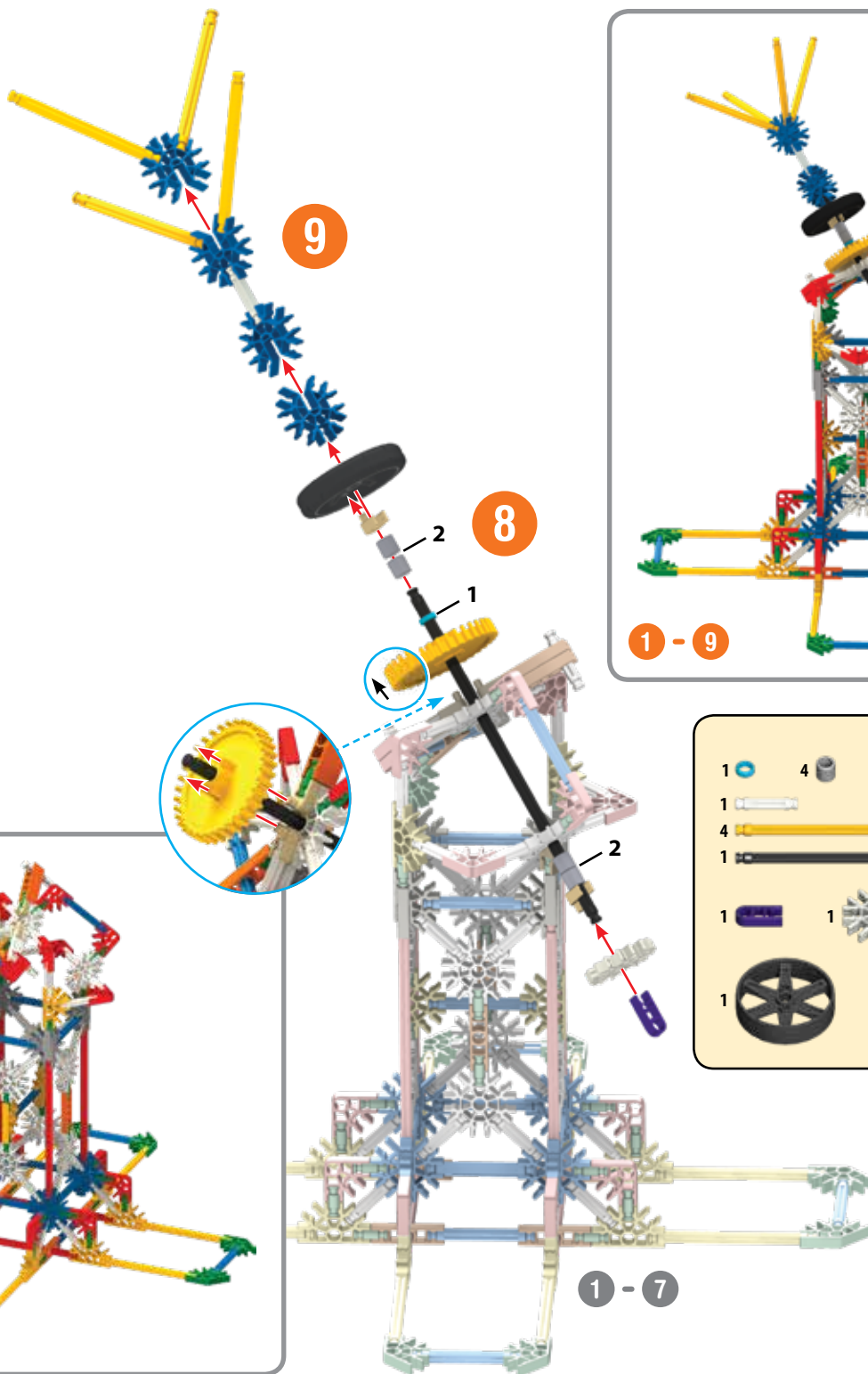
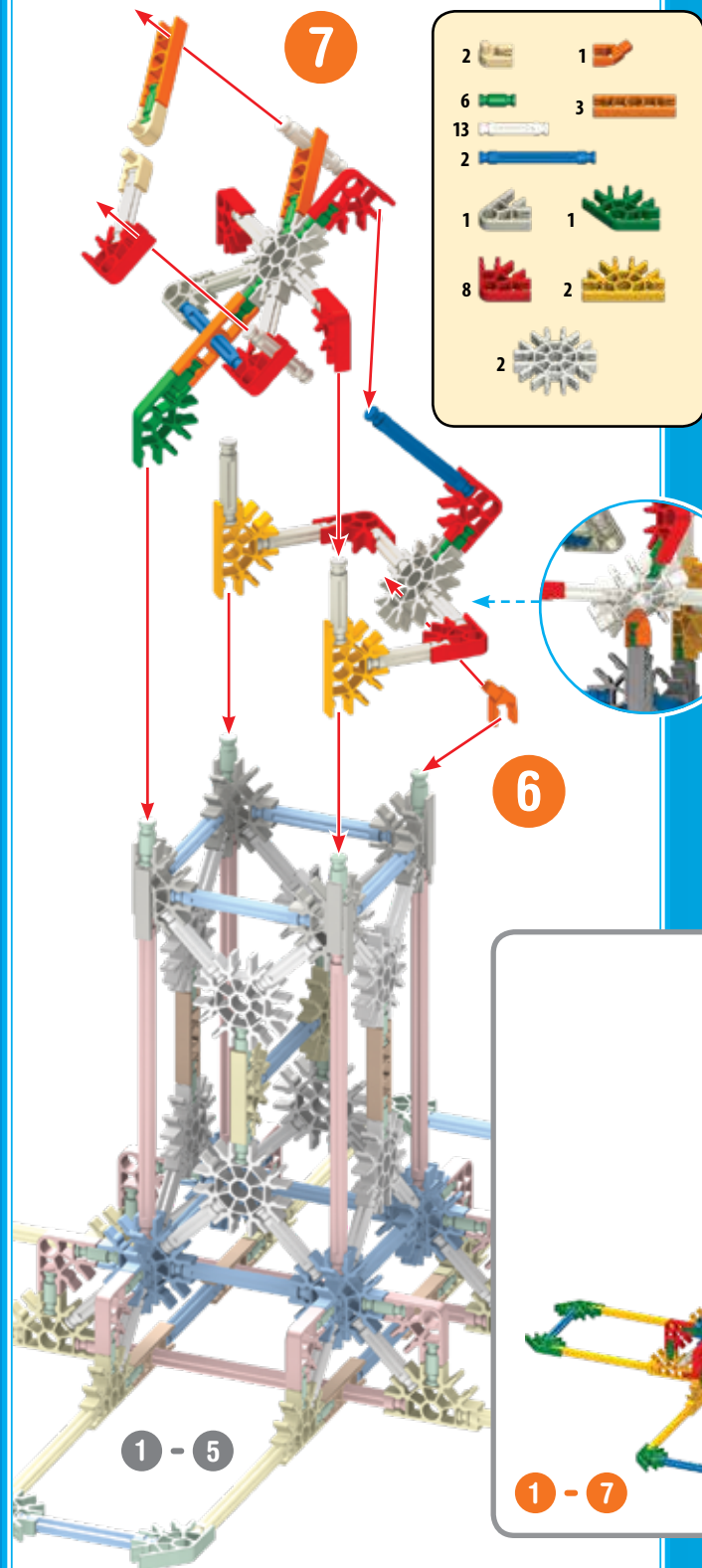

x4

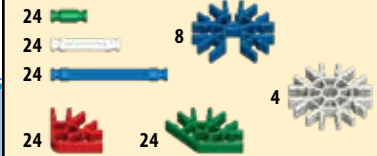
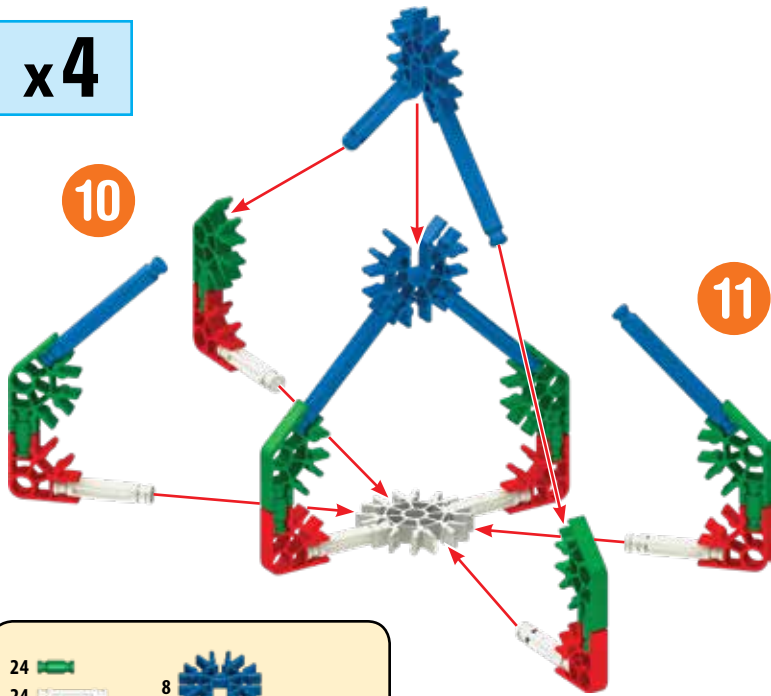

x4



10 - 11



x4



10 - 12

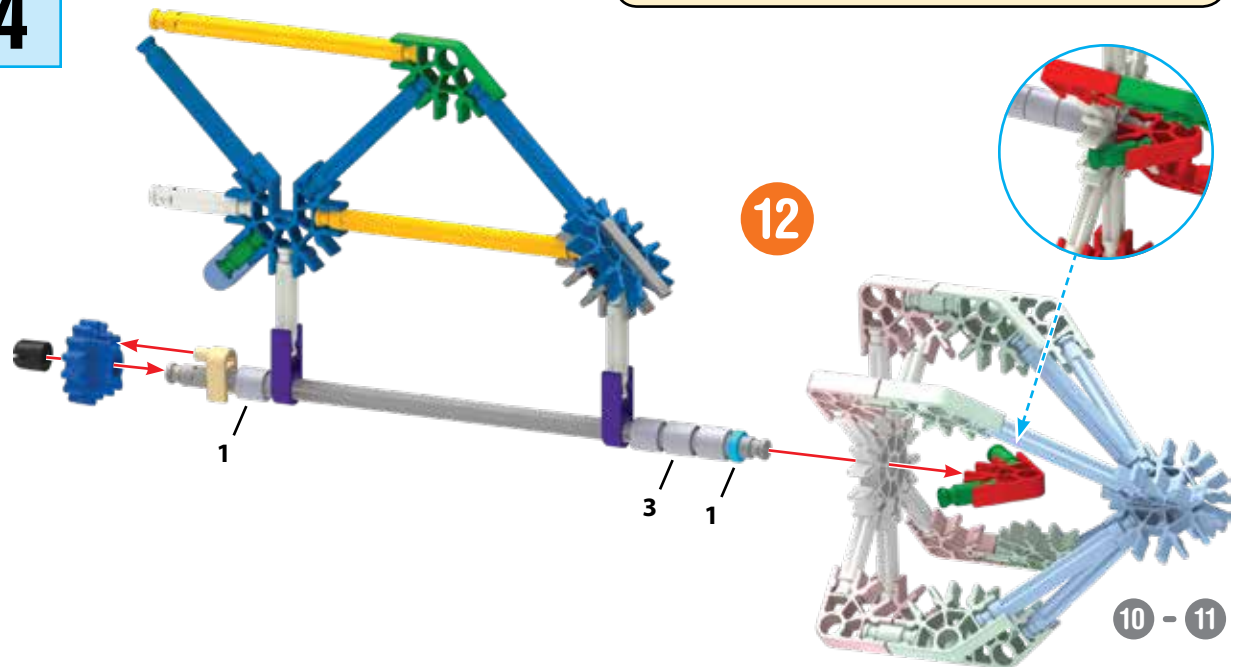

12

10 - 11

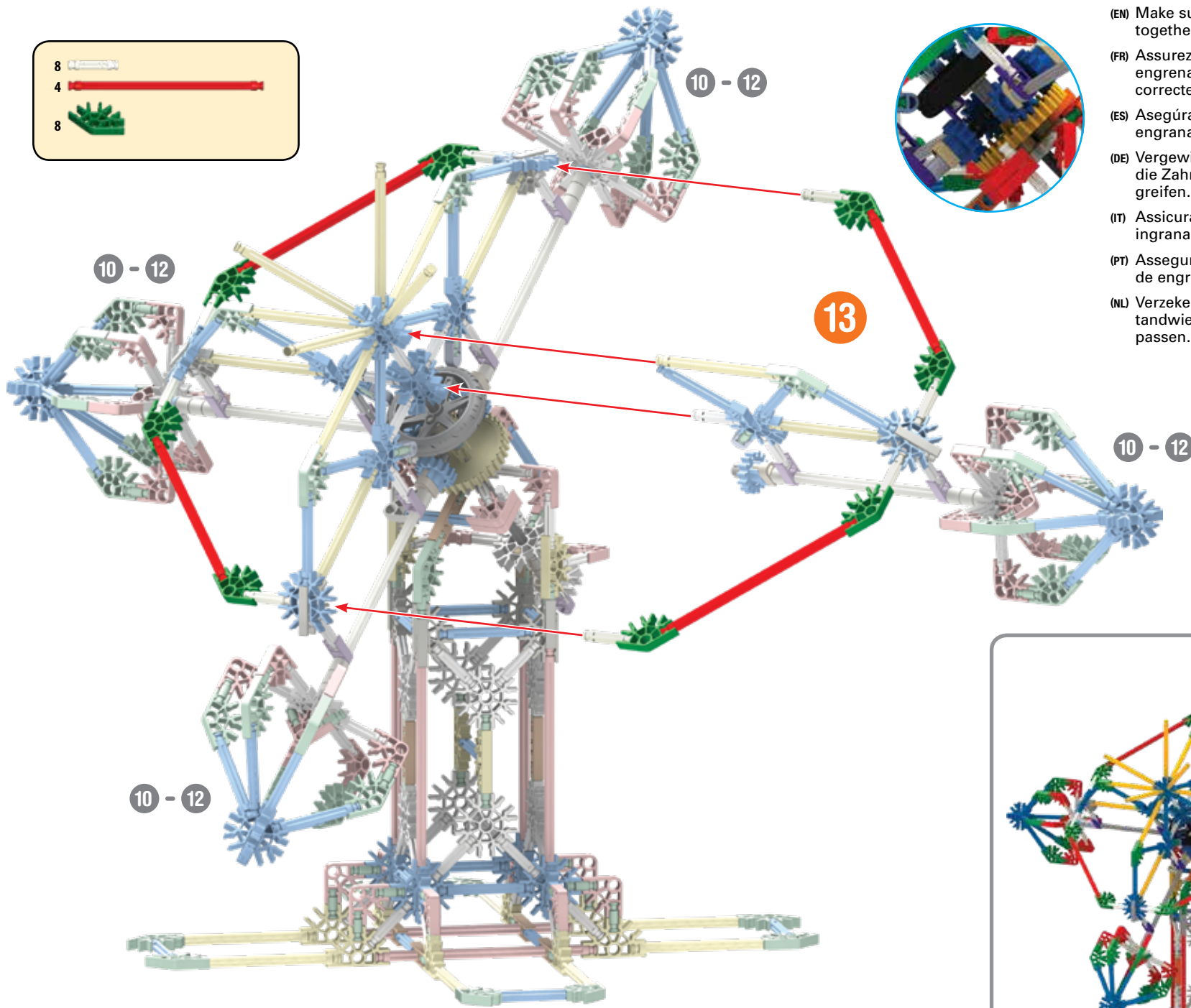
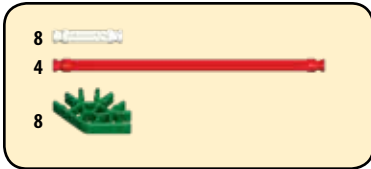

- (EN) Make sure the gears mesh together.
- (FR) Assurez-vous que des engrenages s'engrènent correctement.
- (ES) Asegúrate de que los engranajes concuerdan.
- (DE) Vergewissere dich, dass die Zahnräder ineinander greifen.
- (IT) Assicurarsi gli ingranaggi ingranano.
- (PT) Assegure-se de que malha de engrenagens.
- (NL) Verzeker je ervan dat de tandwielen in mekaar passen.

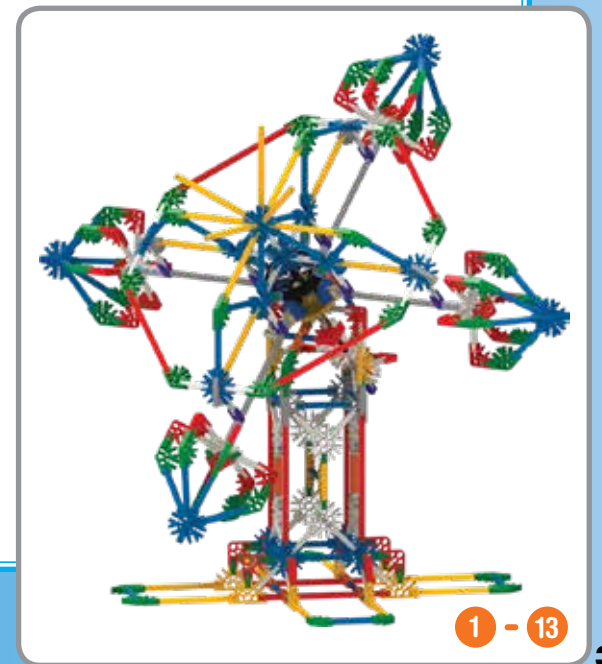

Ambulance Ambulance

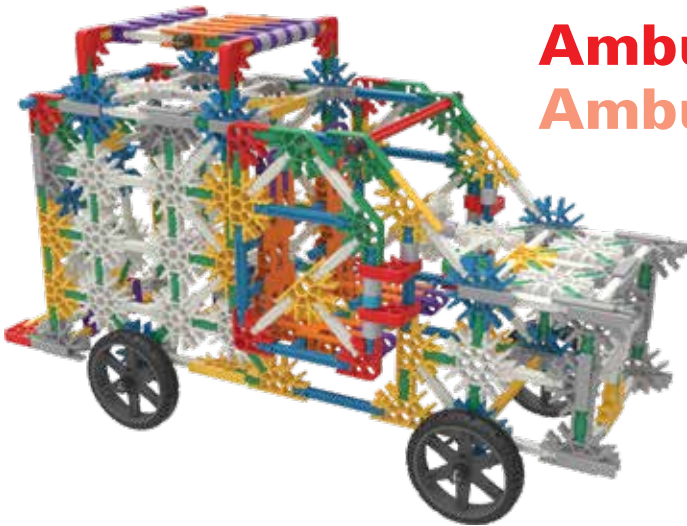

12		4		
6		2		
2		2		
2		2		

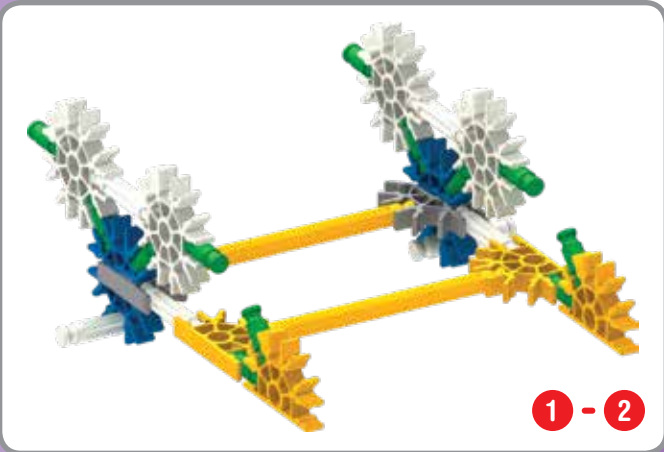
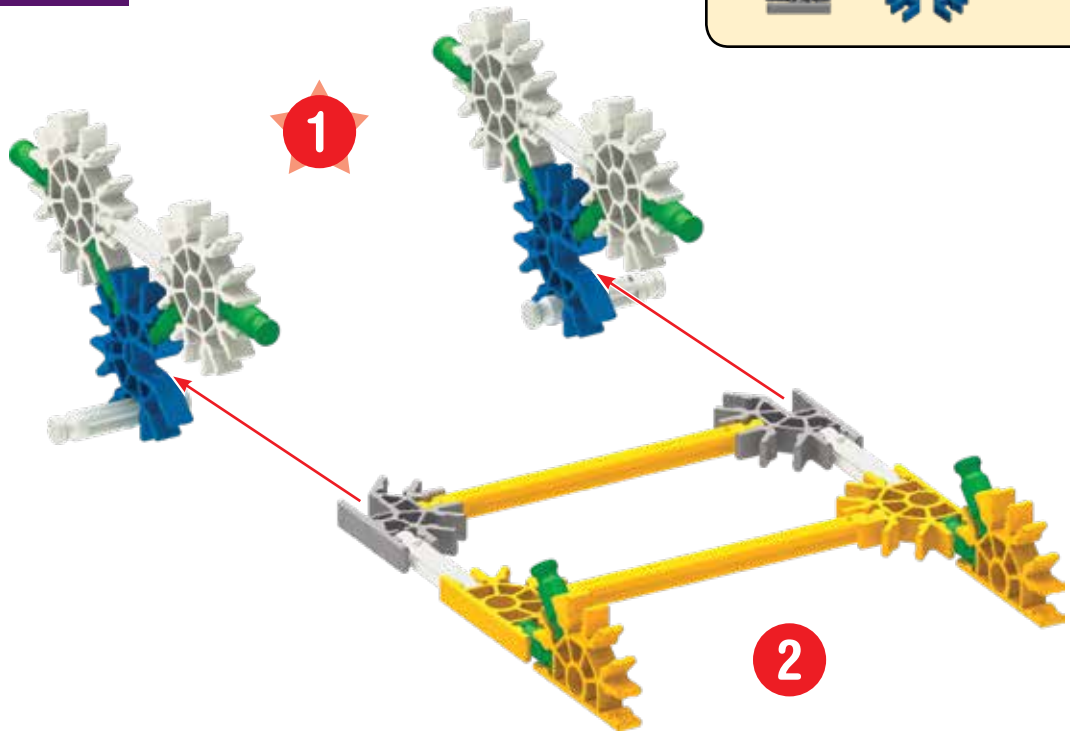

1 - 2

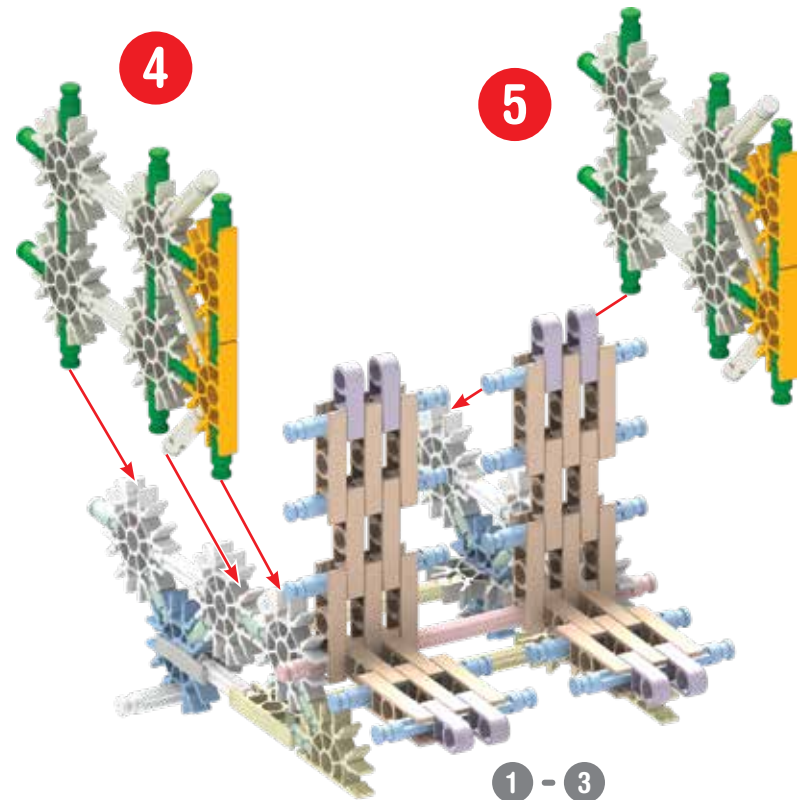
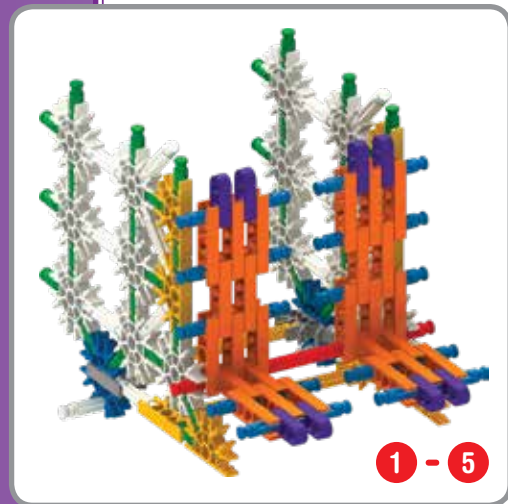
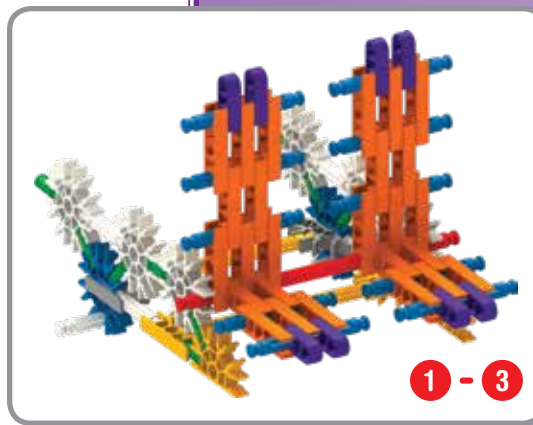
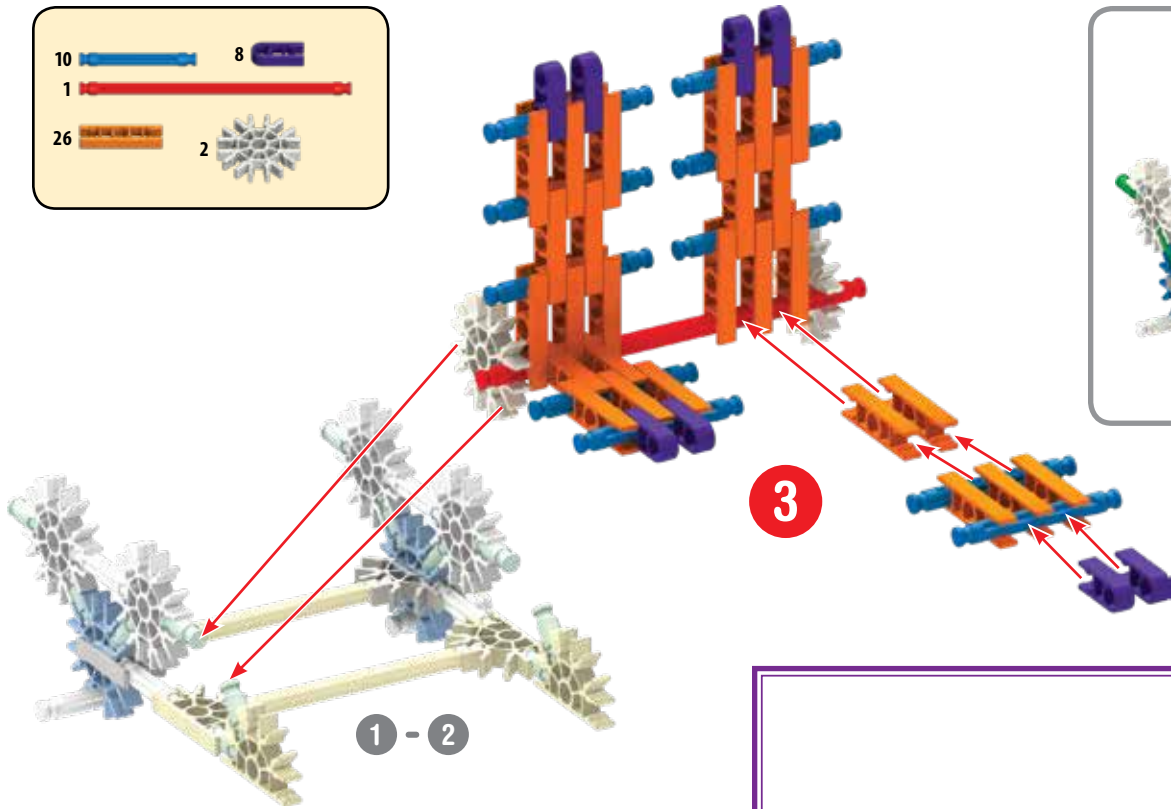
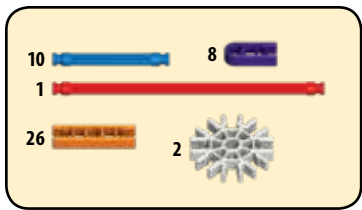

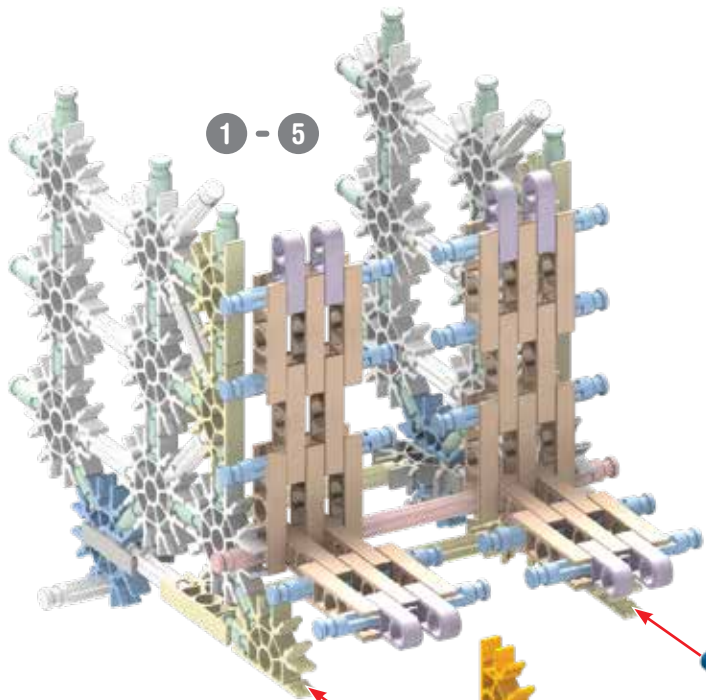

- | | | | |
|----|--|----|--|
| 16 | | 5 | |
| 12 | | 3 | |
| 2 | | 2 | |
| 1 | | 10 | |

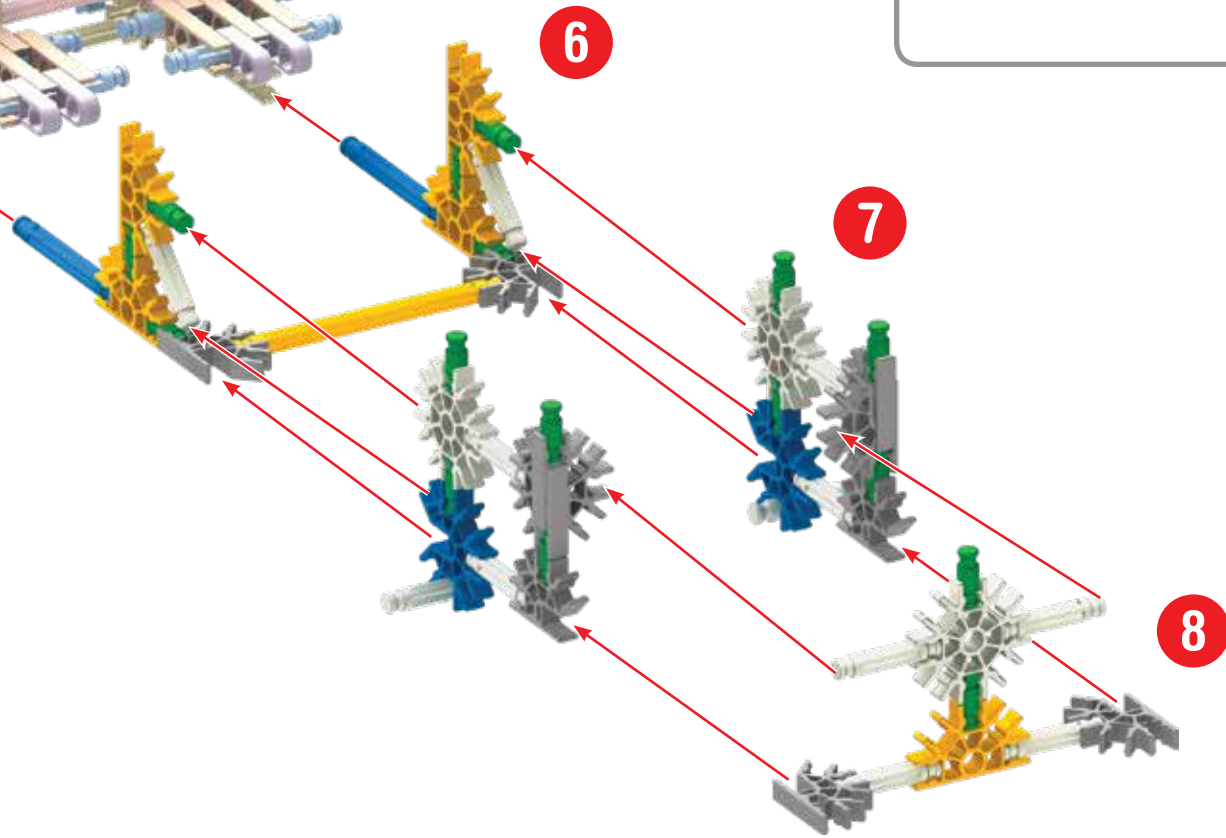
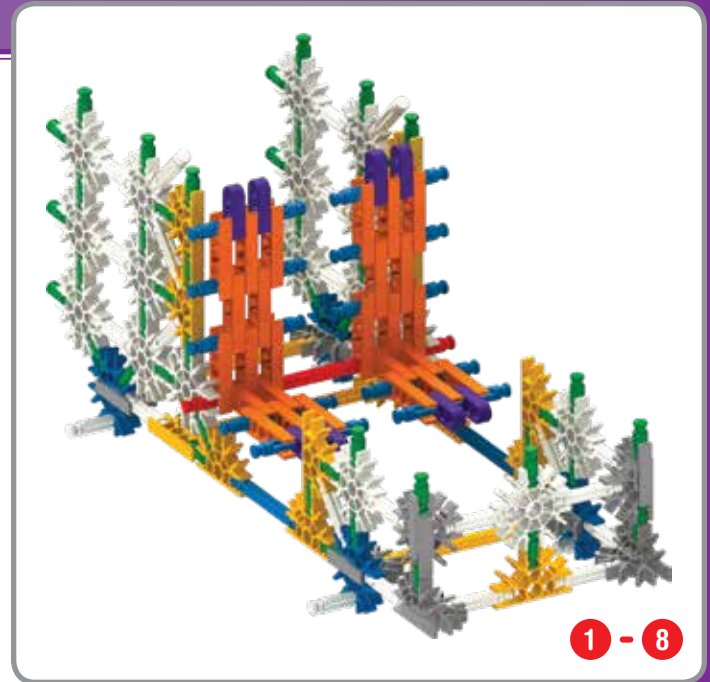

9

1	1	1	1
10	1	1	1
9	2	4	1
8	2	4	1

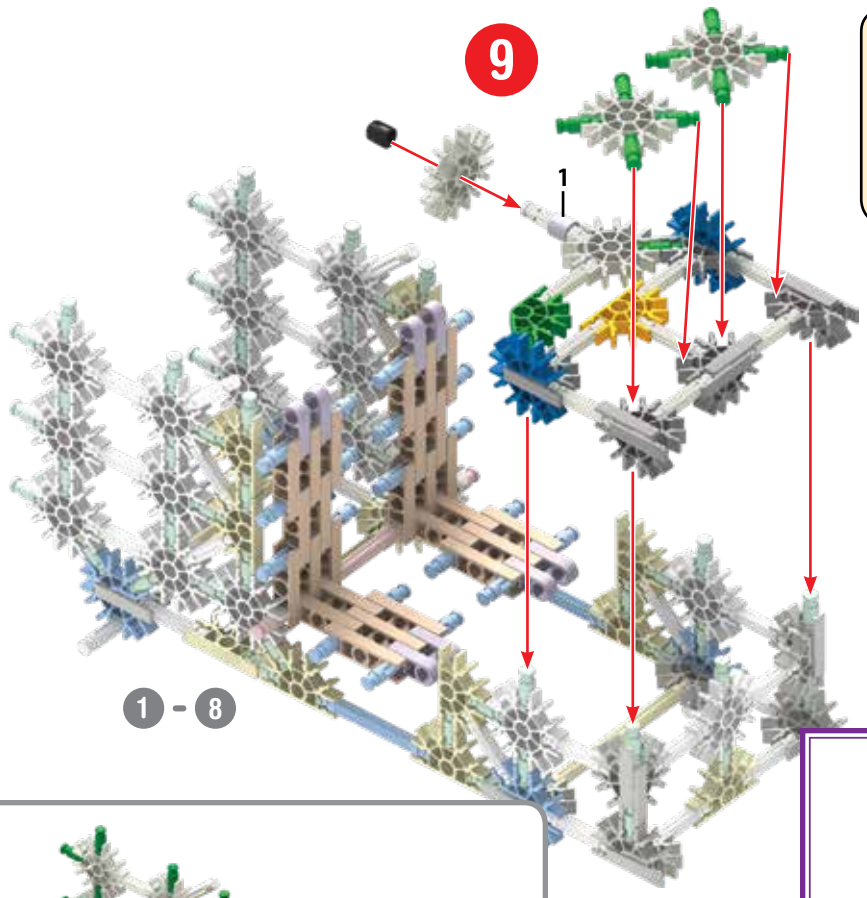

1 - 8

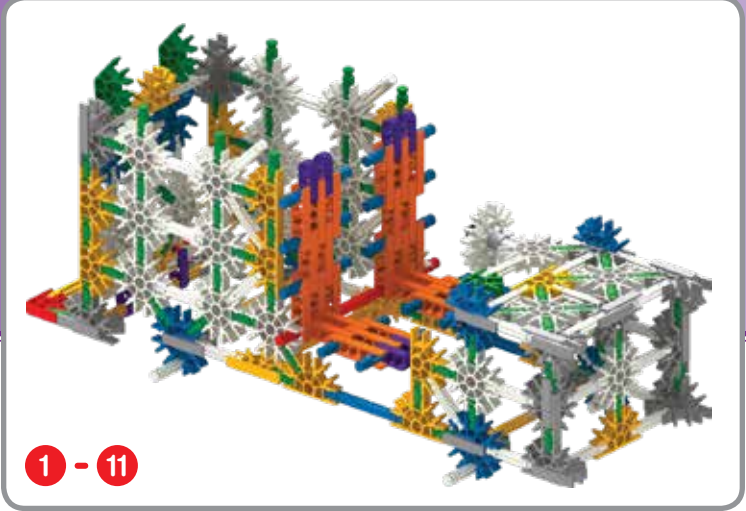

1 - 11

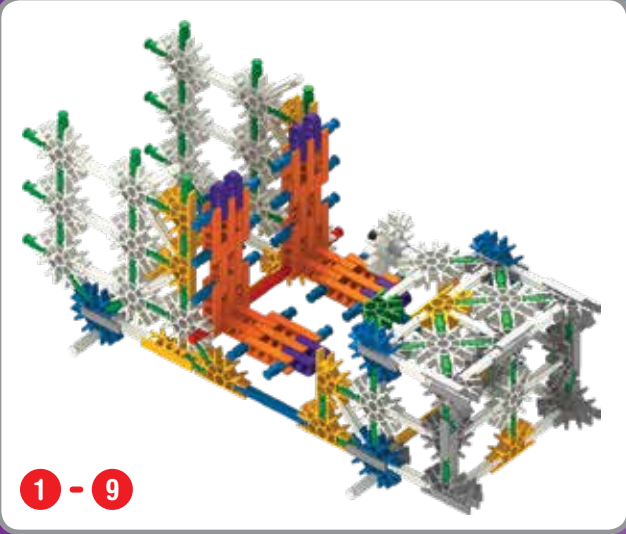

1 - 9



11

16	2	2	3
8	2	2	3
2	2	8	6
2	2	8	6

10

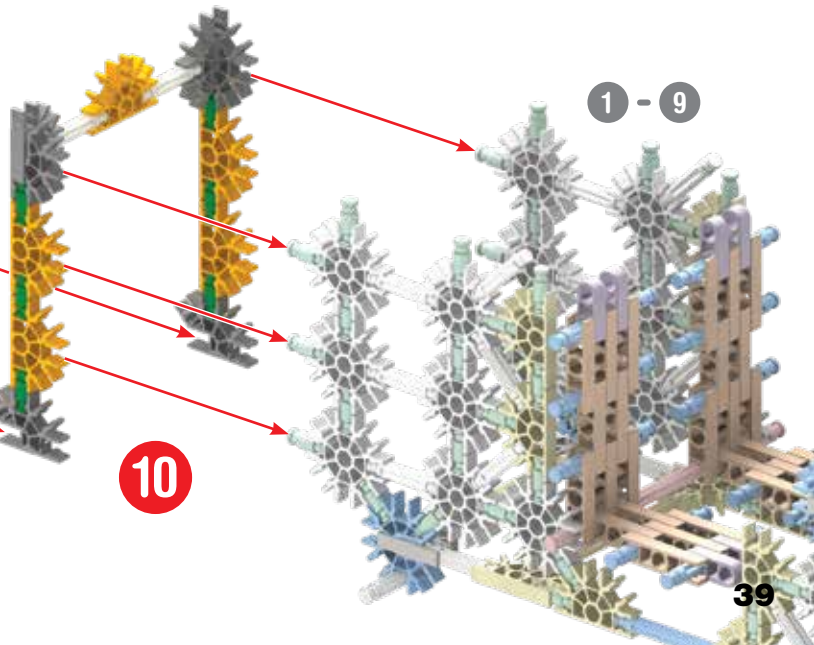

1 - 9

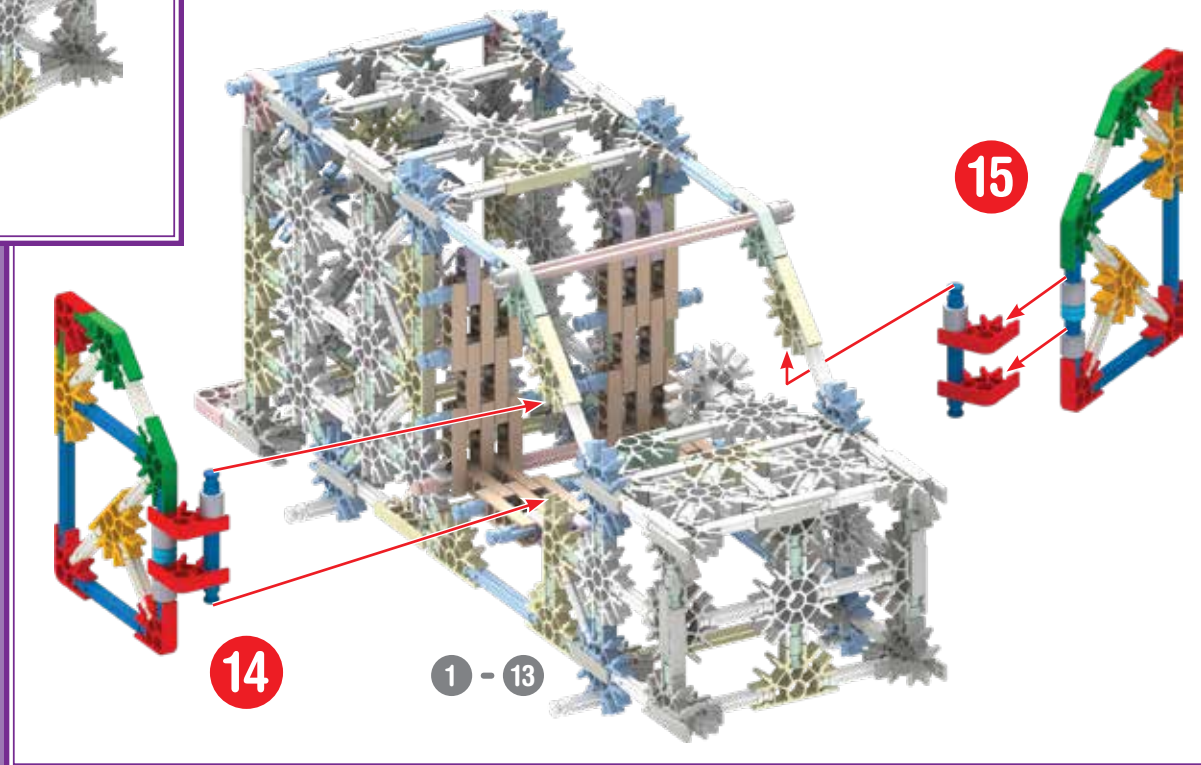
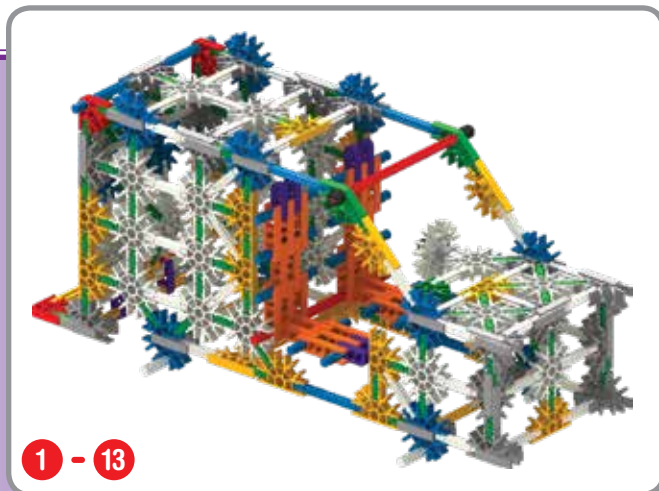
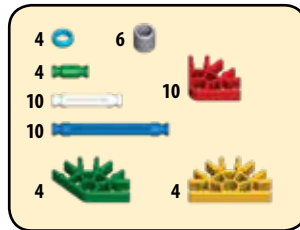
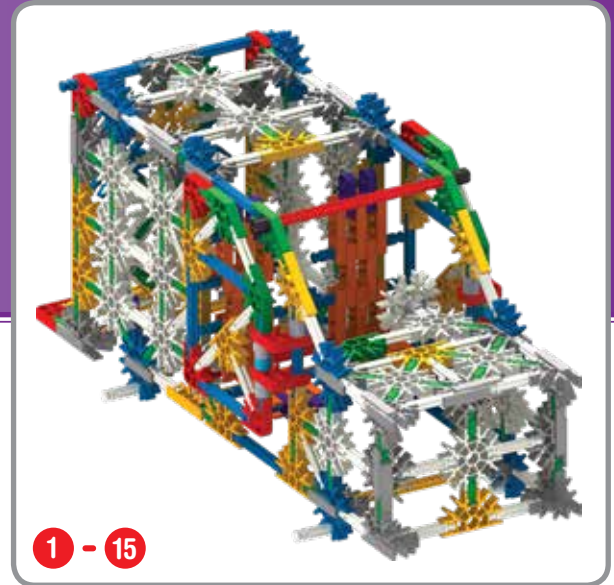
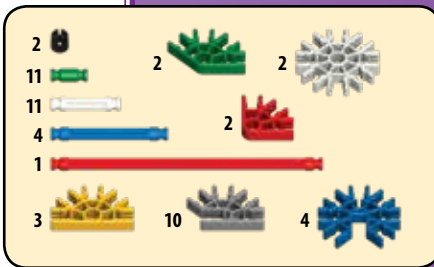
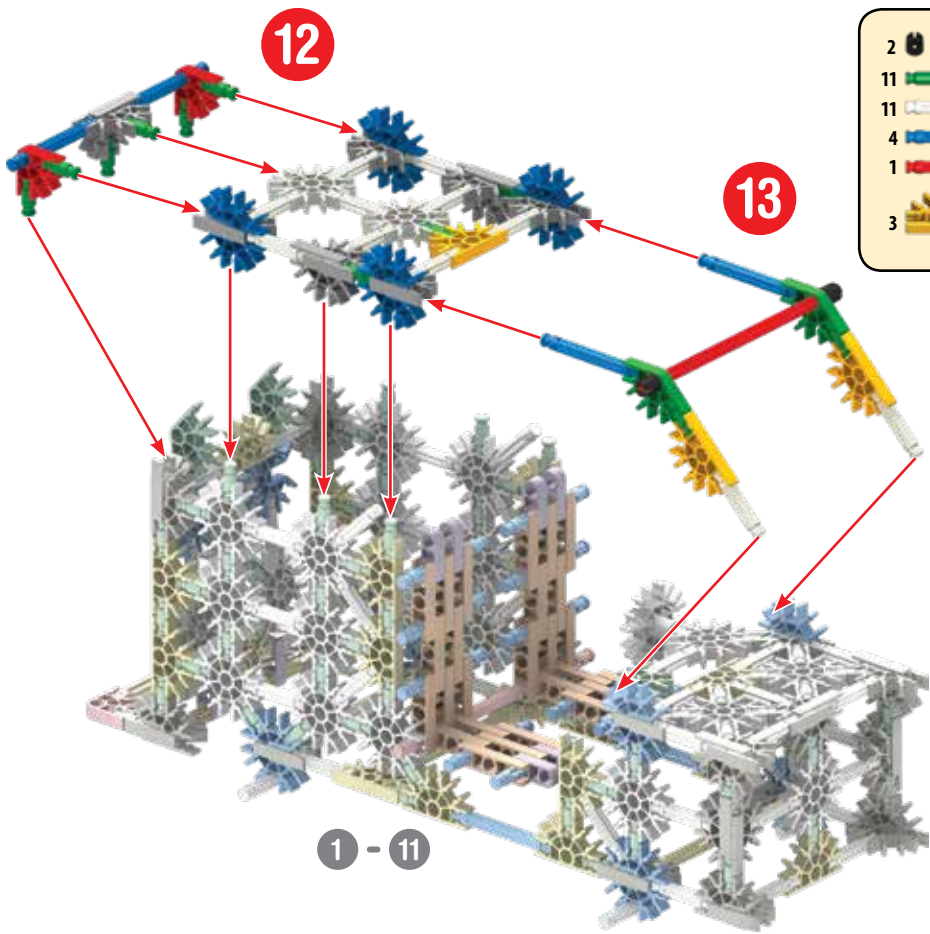

16

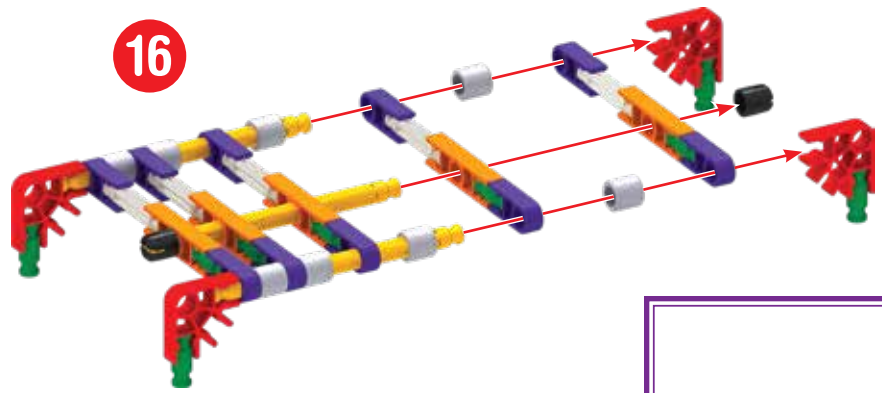

- 2 8
- 9
- 5
- 3
- 10
- 4
- 5

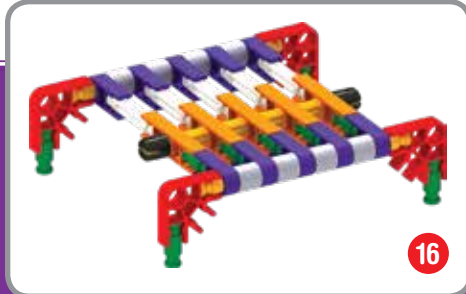

16



1 - 19

17

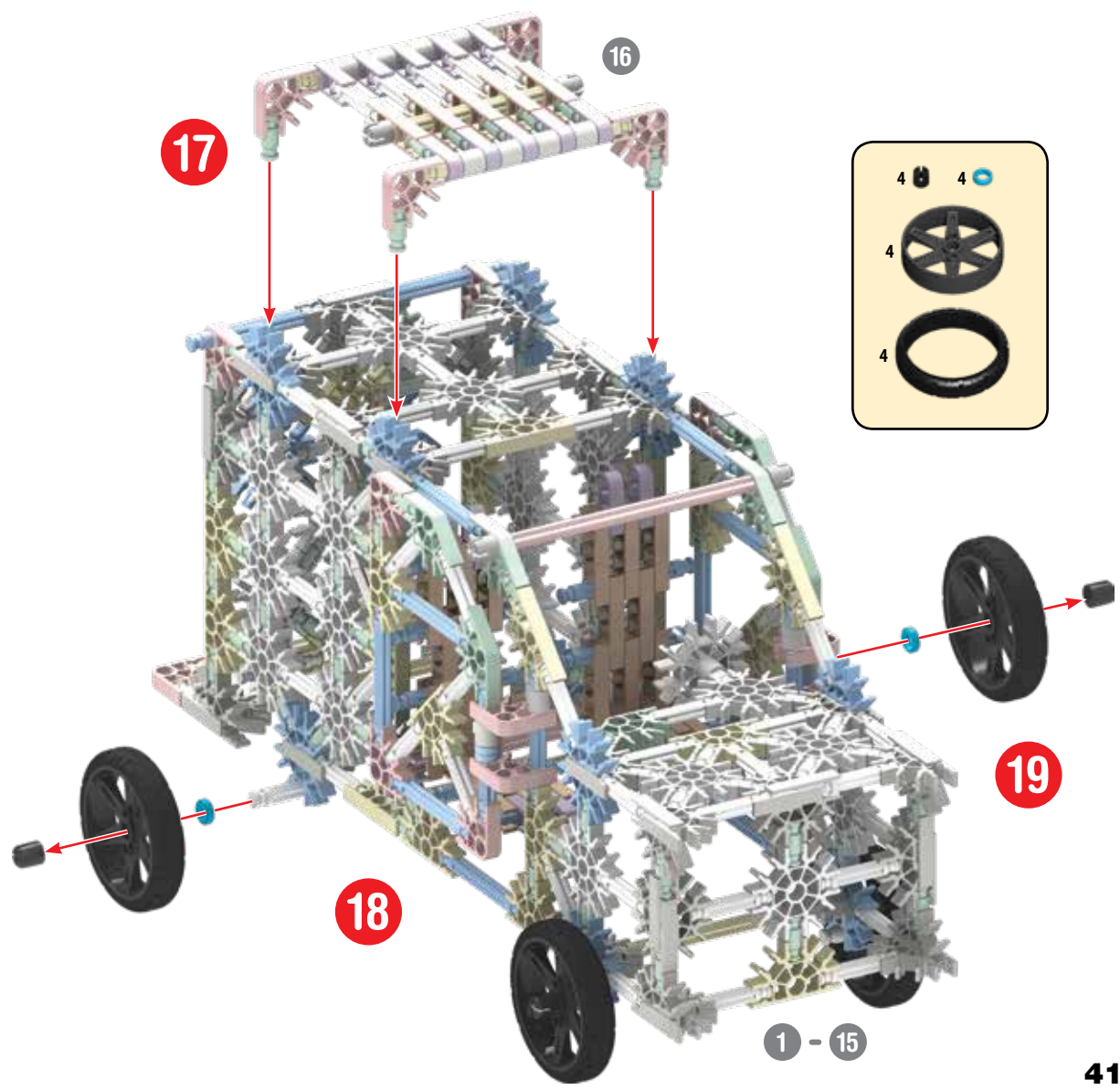

16

- 4
- 4
- 4
- 4

18

19

1 - 15

Large Helicopter Grand Hélicoptère

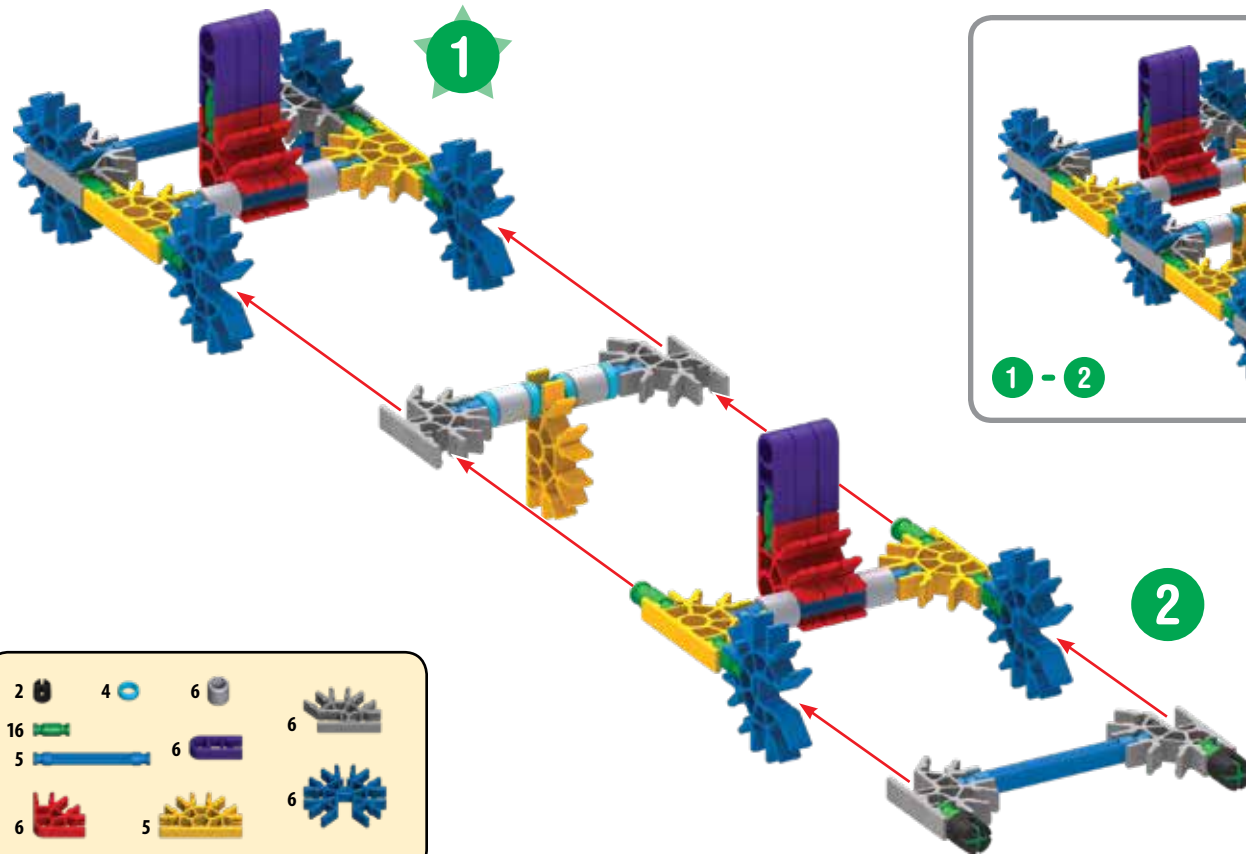

2	4	6	
16		6	6
5		5	6
6			

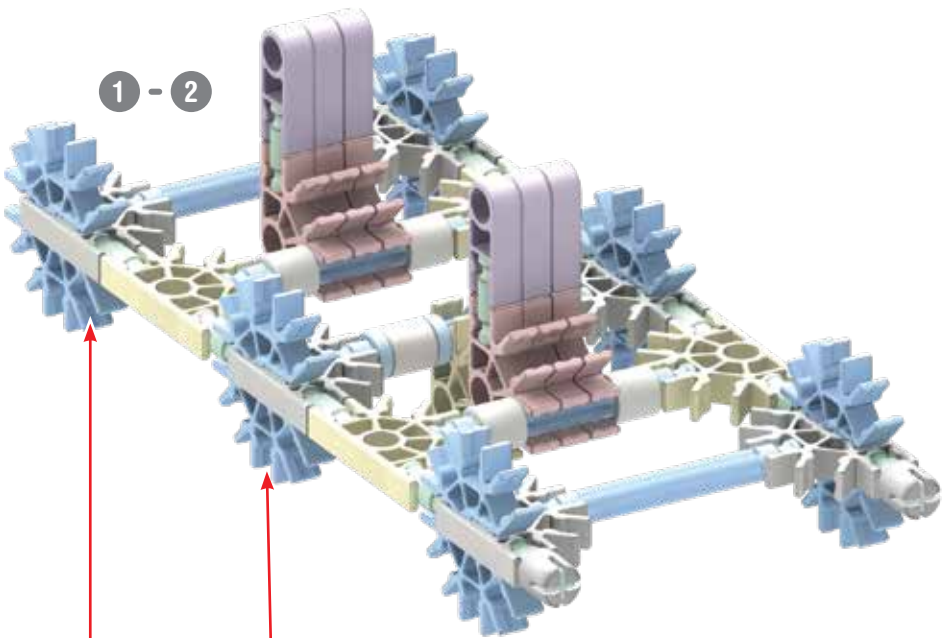

1 - 2

- | | | | |
|----|--|---|--|
| 4 | | 8 | |
| 12 | | | |
| 4 | | | |
| 1 | | | |
| 2 | | 2 | |

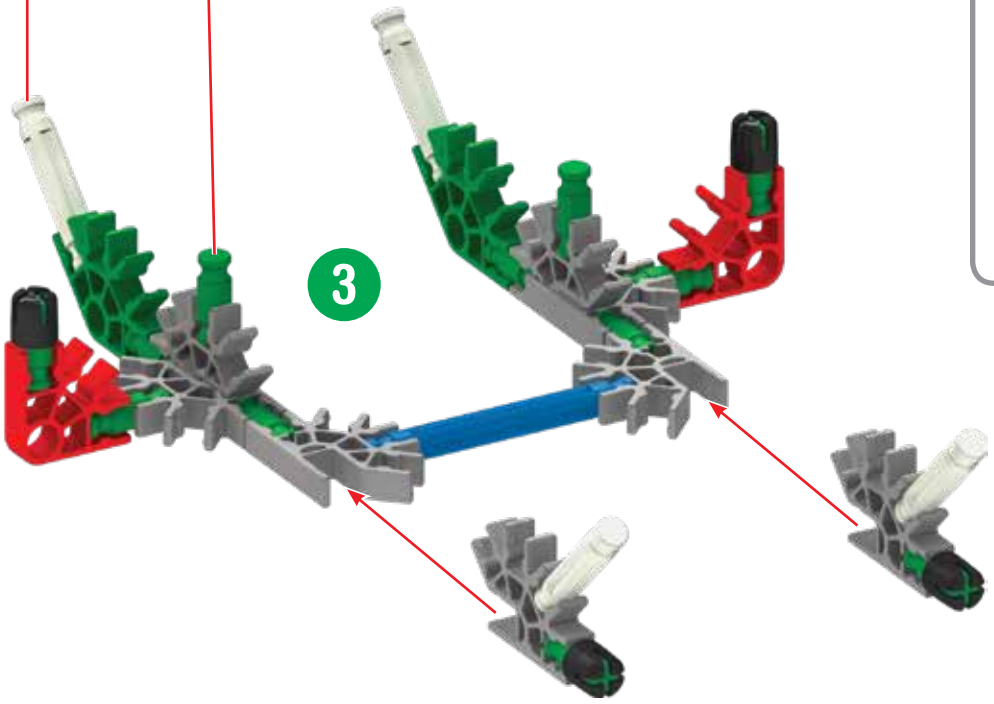

3

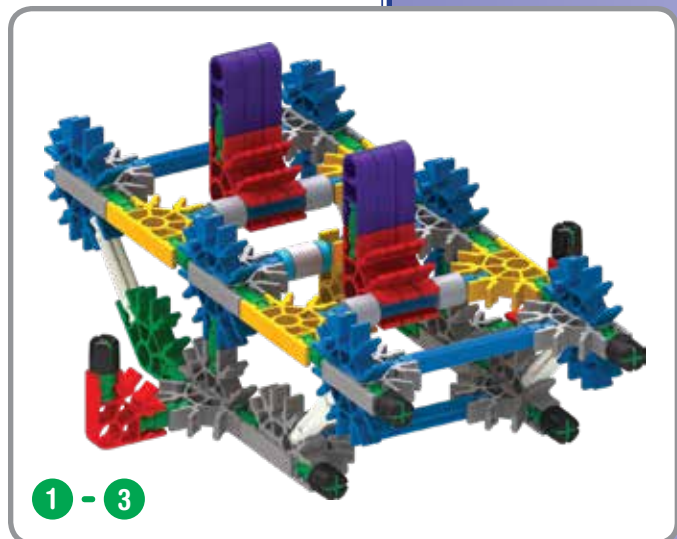

1 - 3

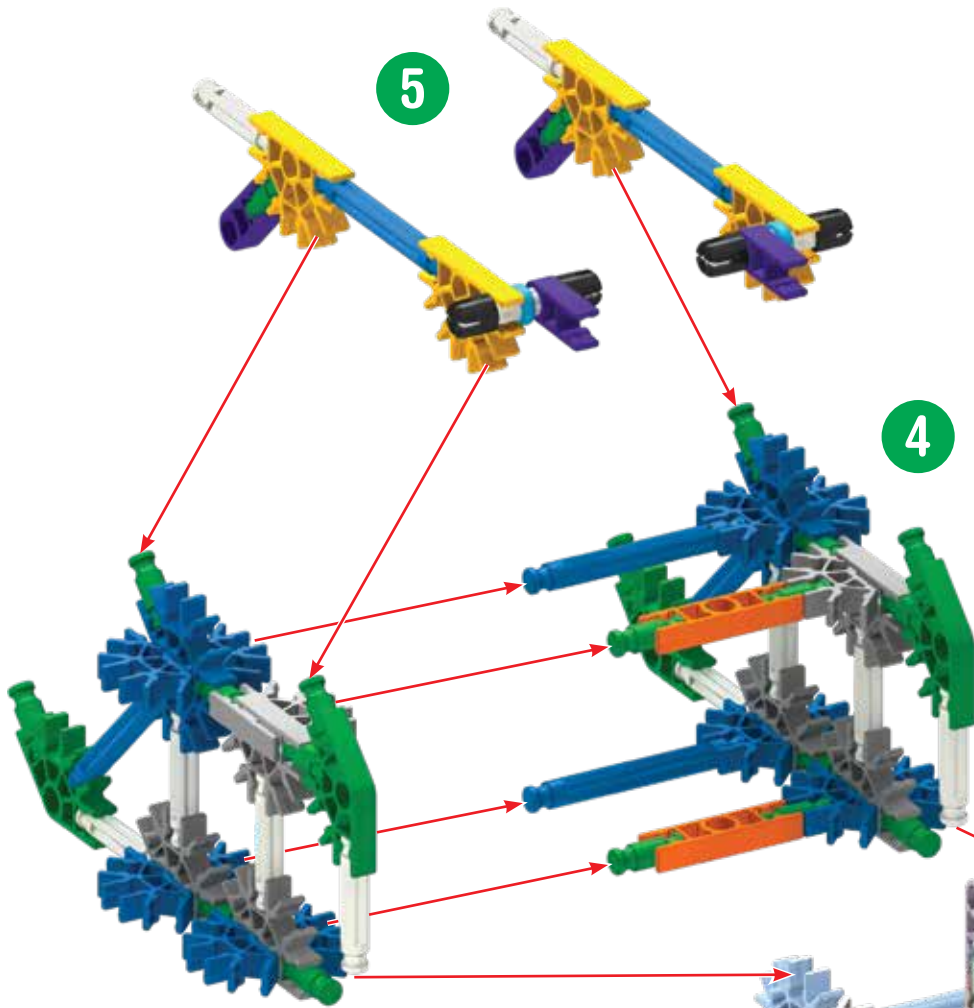

20		2		4		2	
12				4		4	
6							
4		8		8			

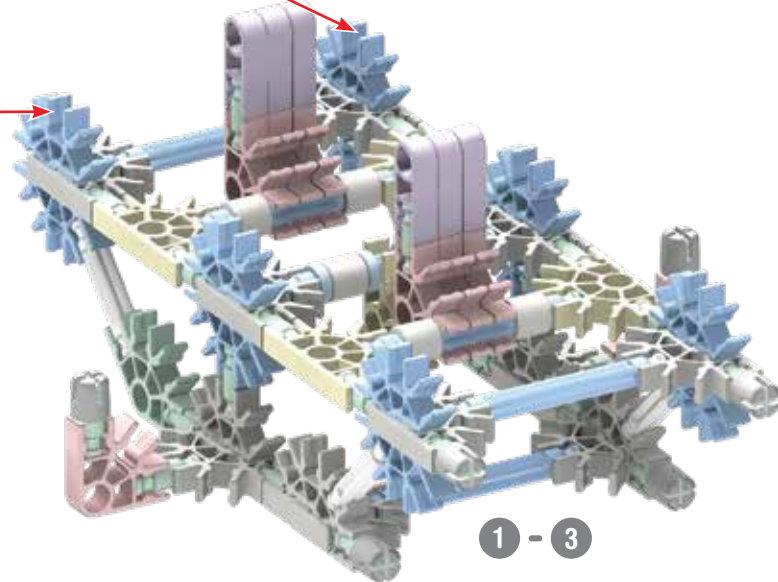

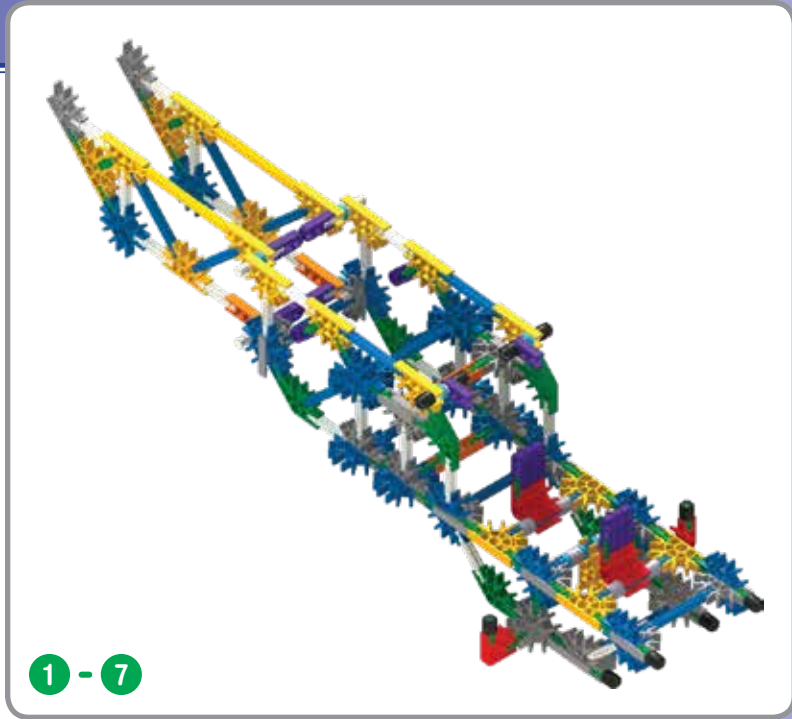
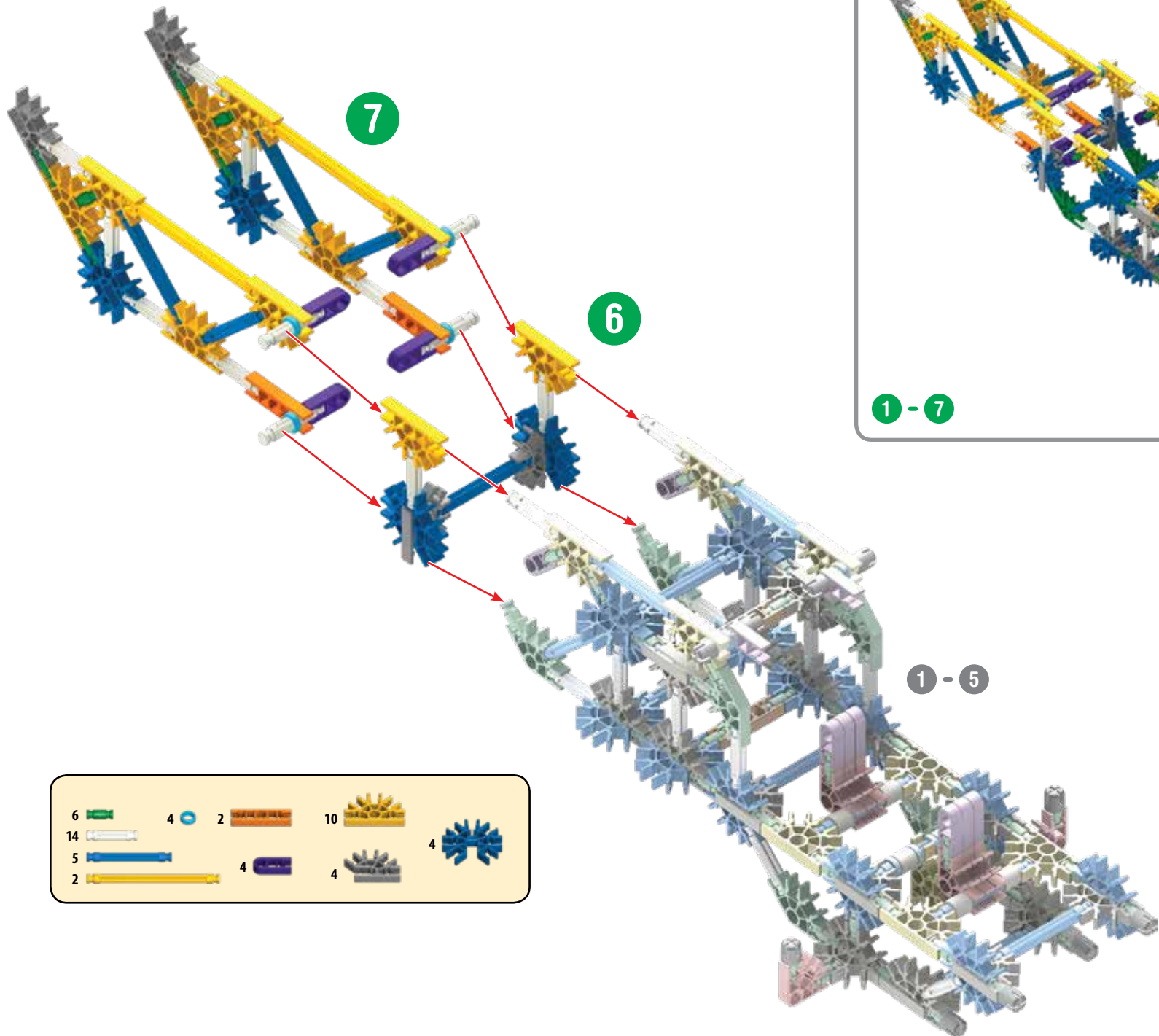

- | | | | | | | | | | |
|----|--|---|--|---|--|----|--|---|--|
| 6 | | 4 | | 2 | | 10 | | | |
| 14 | | | | | | | | | |
| 5 | | | | 4 | | 4 | | 4 | |
| 2 | | | | | | | | | |

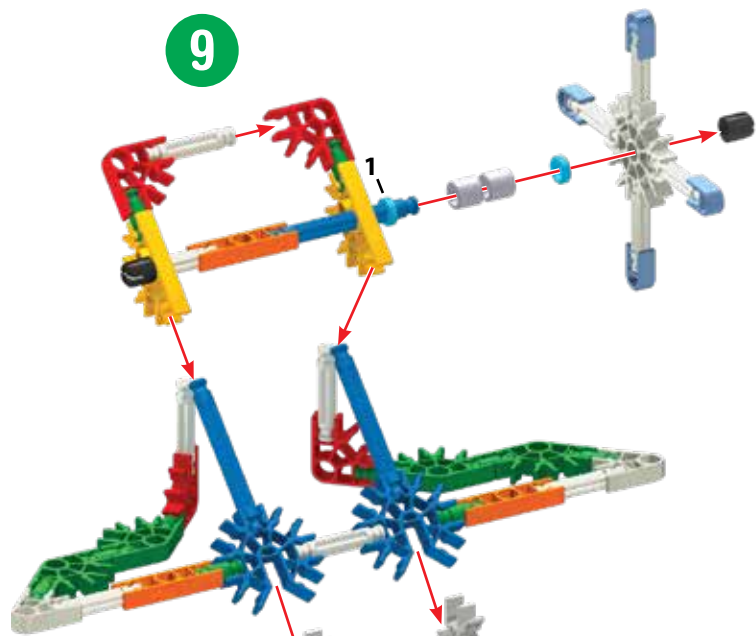

9

8

1 - 7



1 - 9

- | | | | | |
|----|---|---|---|---|
| 2 | 2 | 2 | 2 | 3 |
| 10 | | 4 | 4 | 4 |
| 11 | | | | |
| 3 | | 2 | 1 | |
| 2 | | | | |

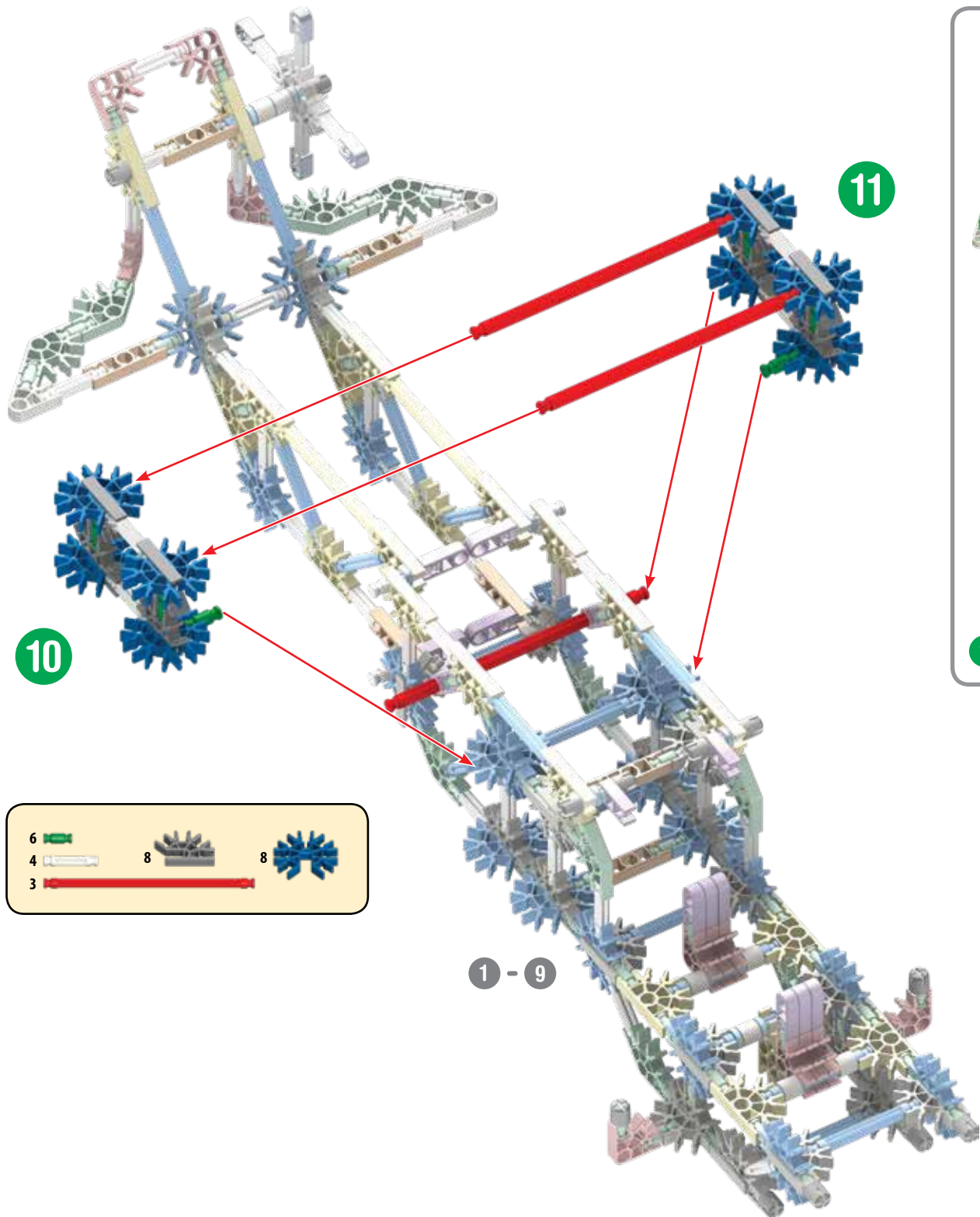

- | | | | | | |
|---|--|---|--|---|--|
| 6 | | 8 | | 8 | |
| 4 | | | | | |
| 3 | | | | | |

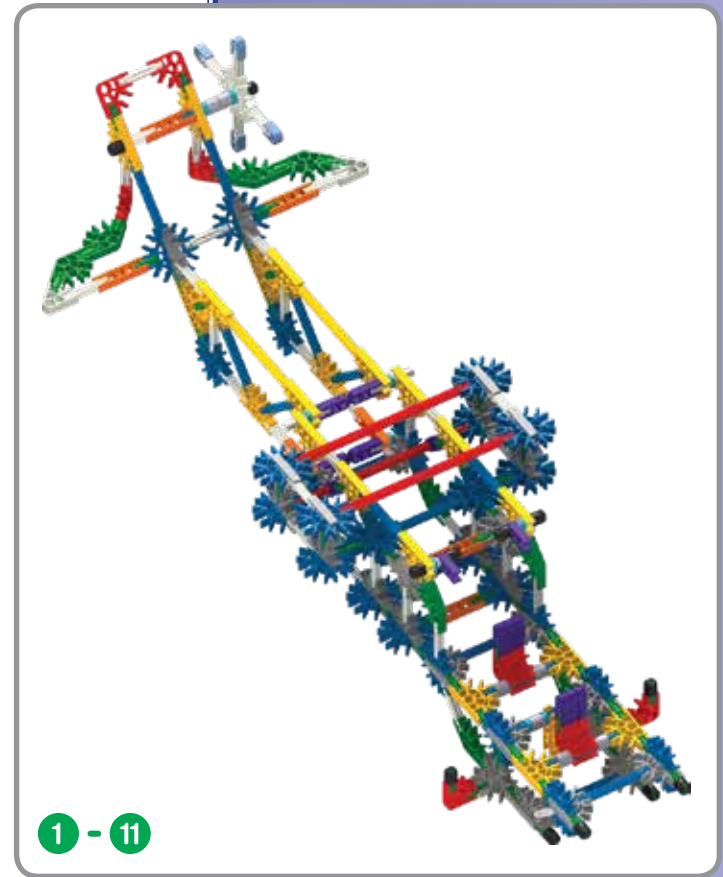

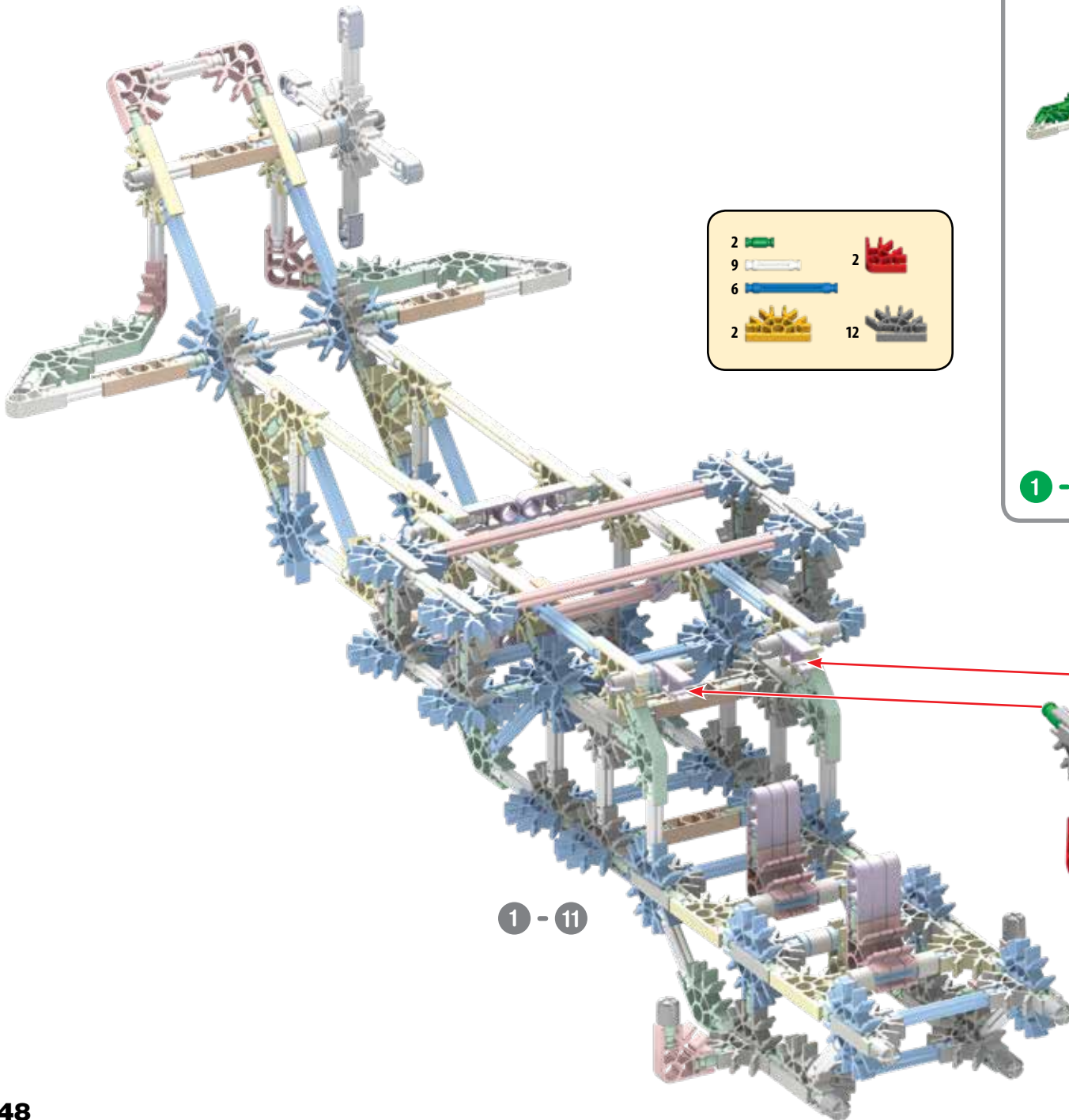

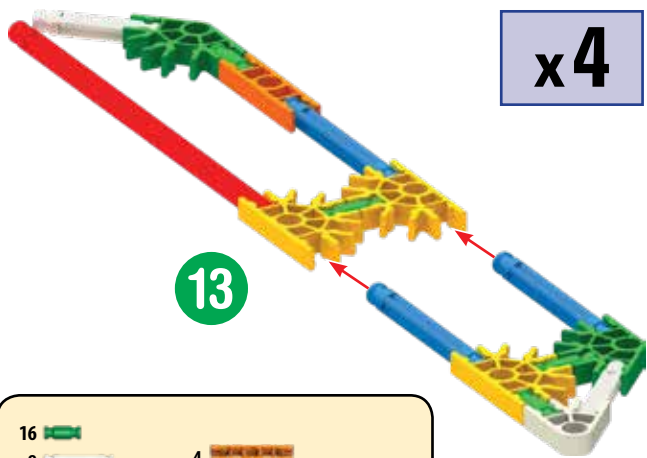

x4

13

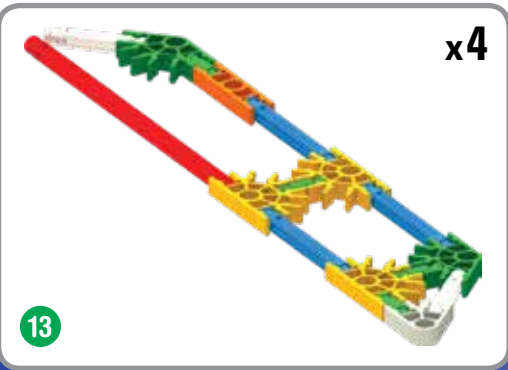
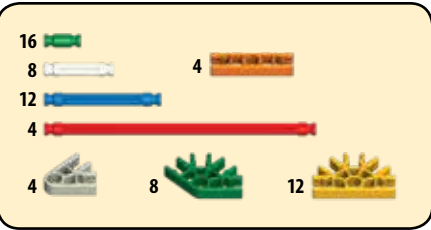

x4

13

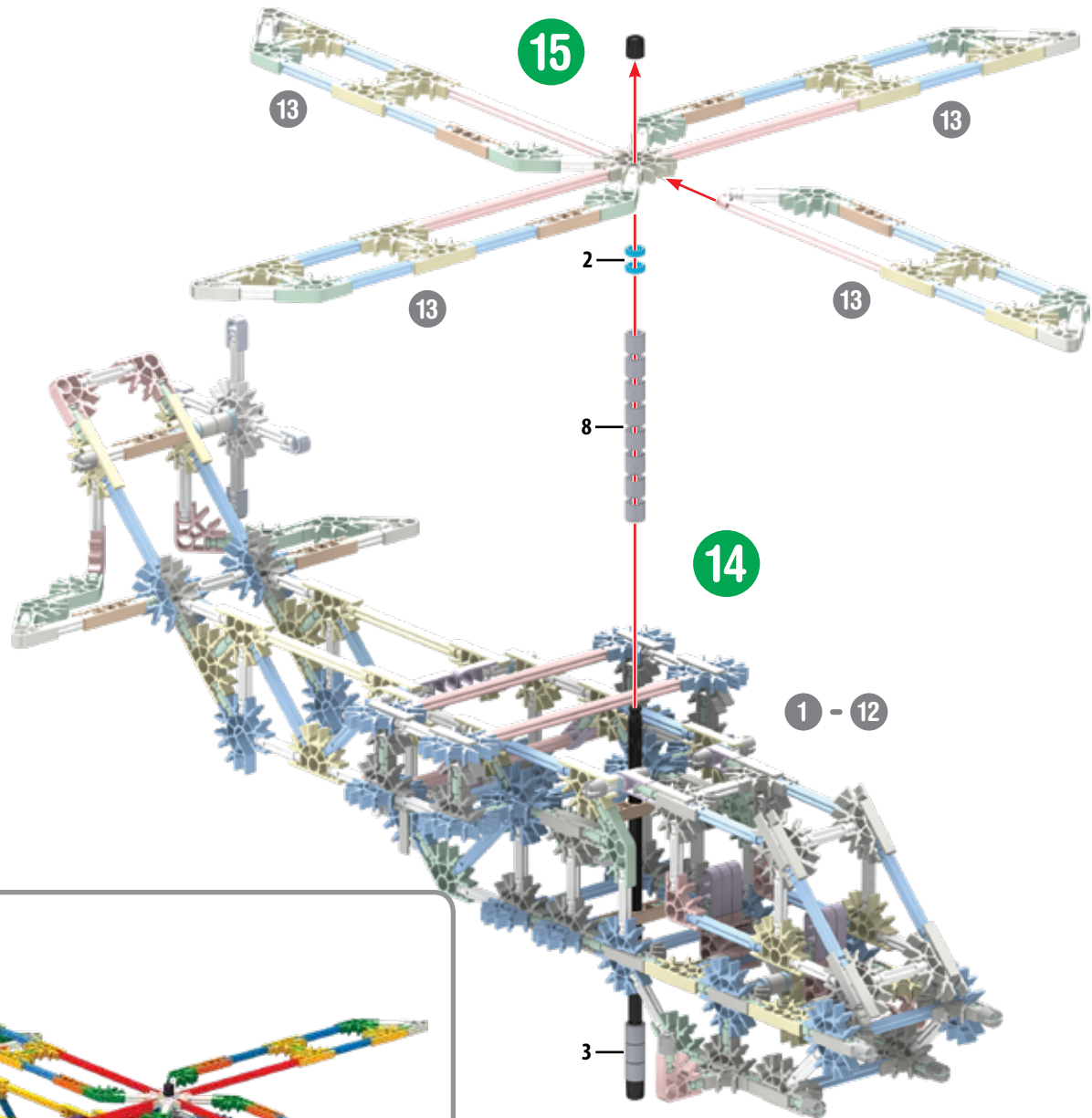

15

13

13

13

13

2

8

14

1 - 12

3

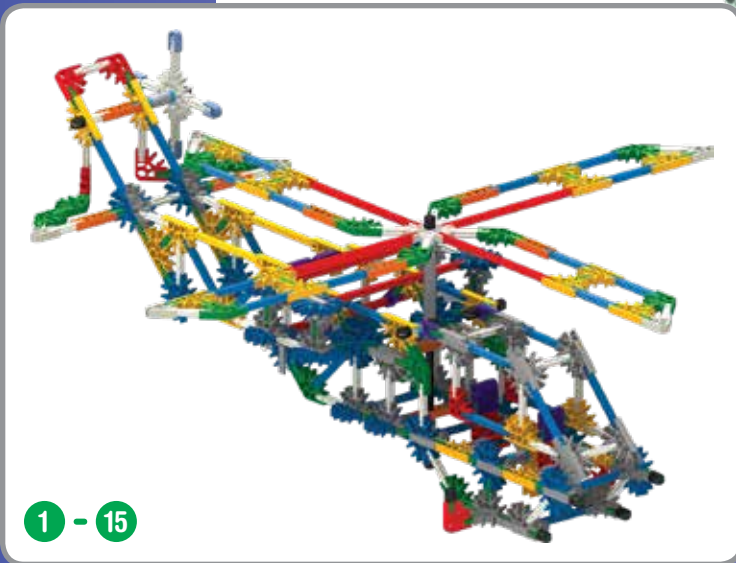

1 - 15



16

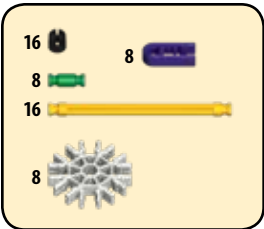
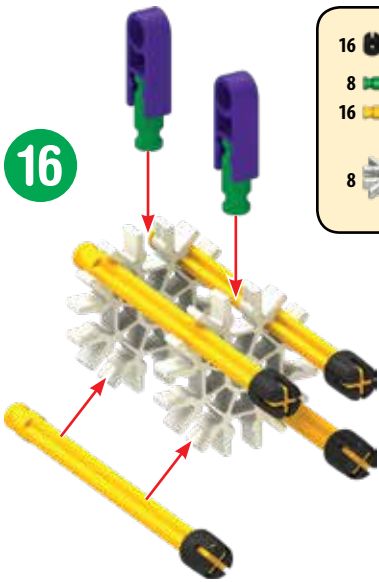

x4

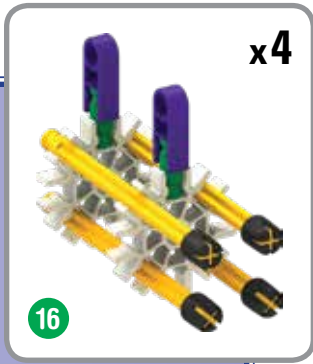

16

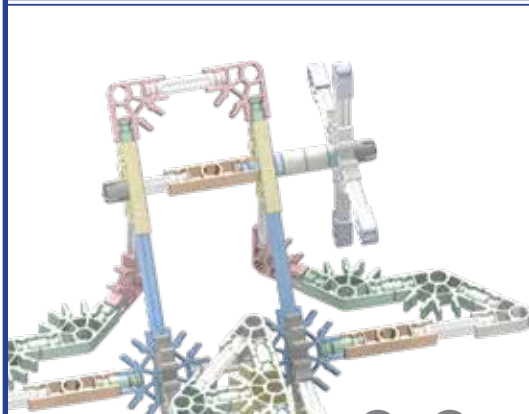

1 - 15



1 - 18

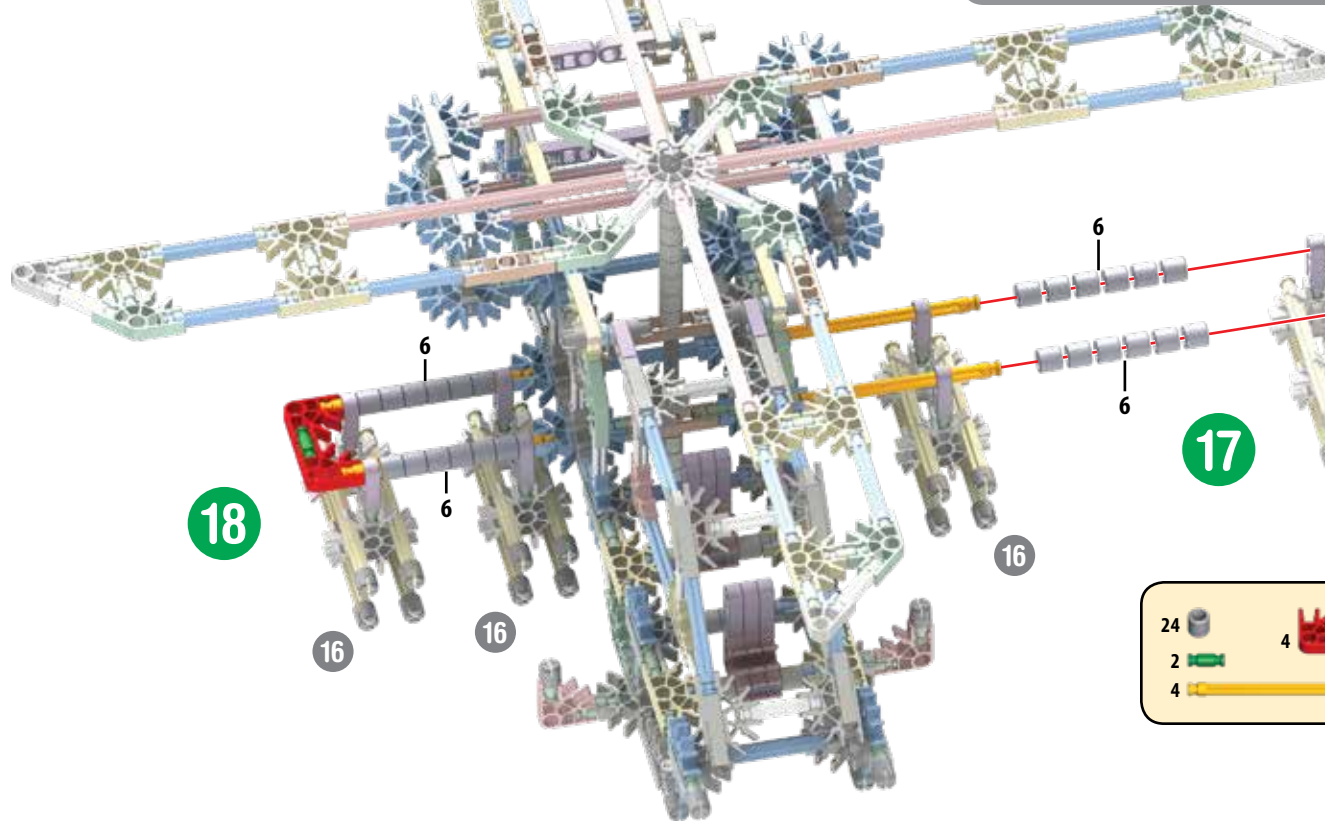

18

16

16

16

17

16

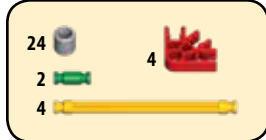

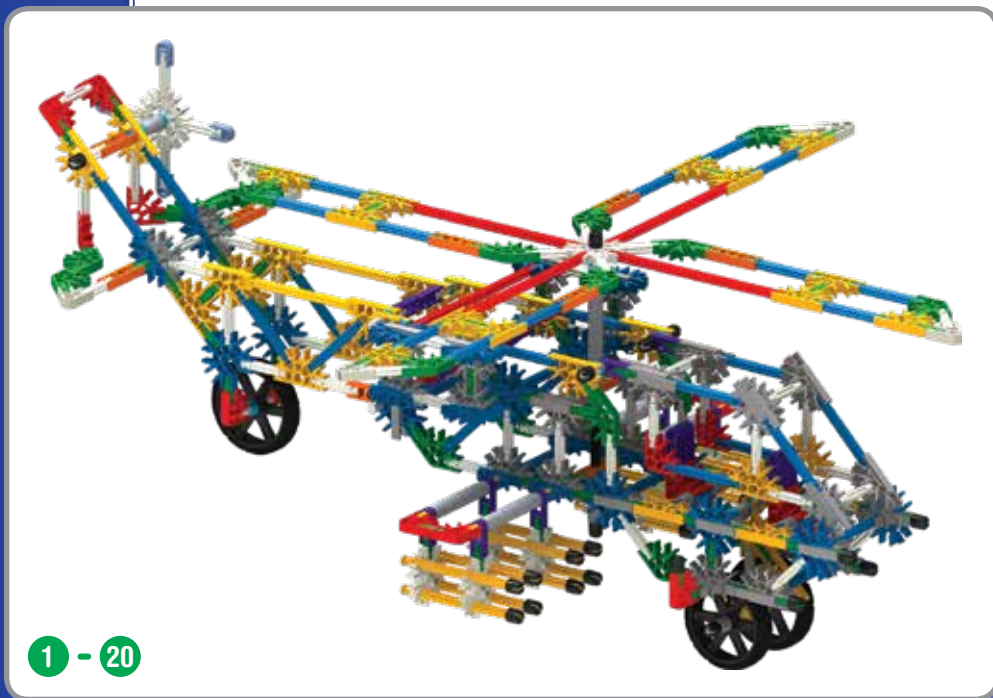
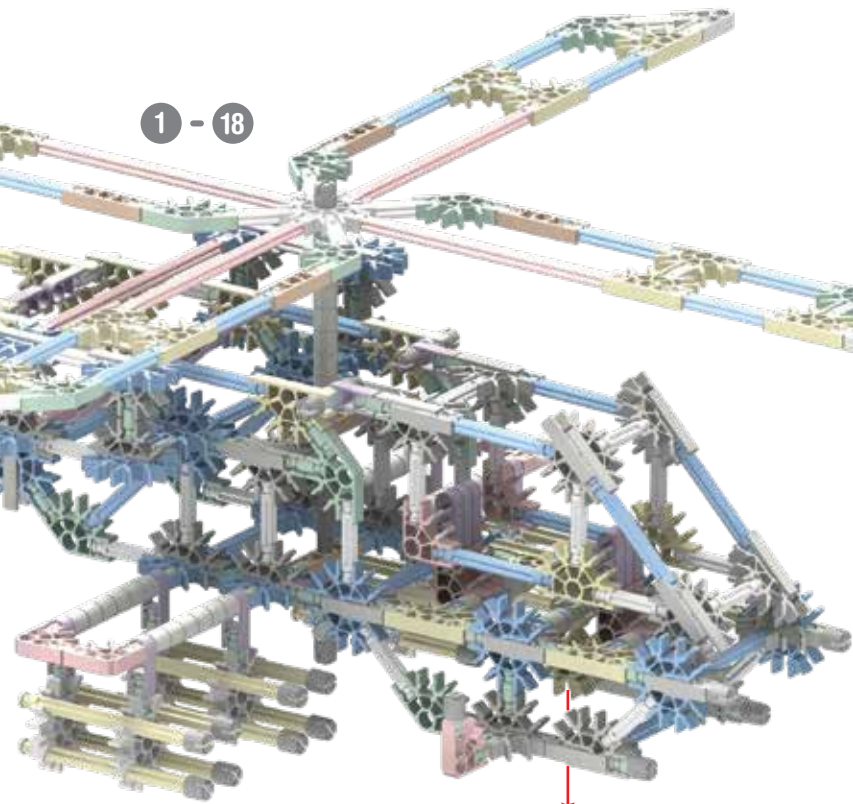
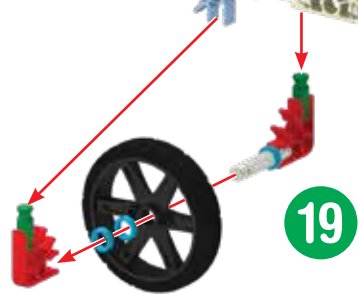
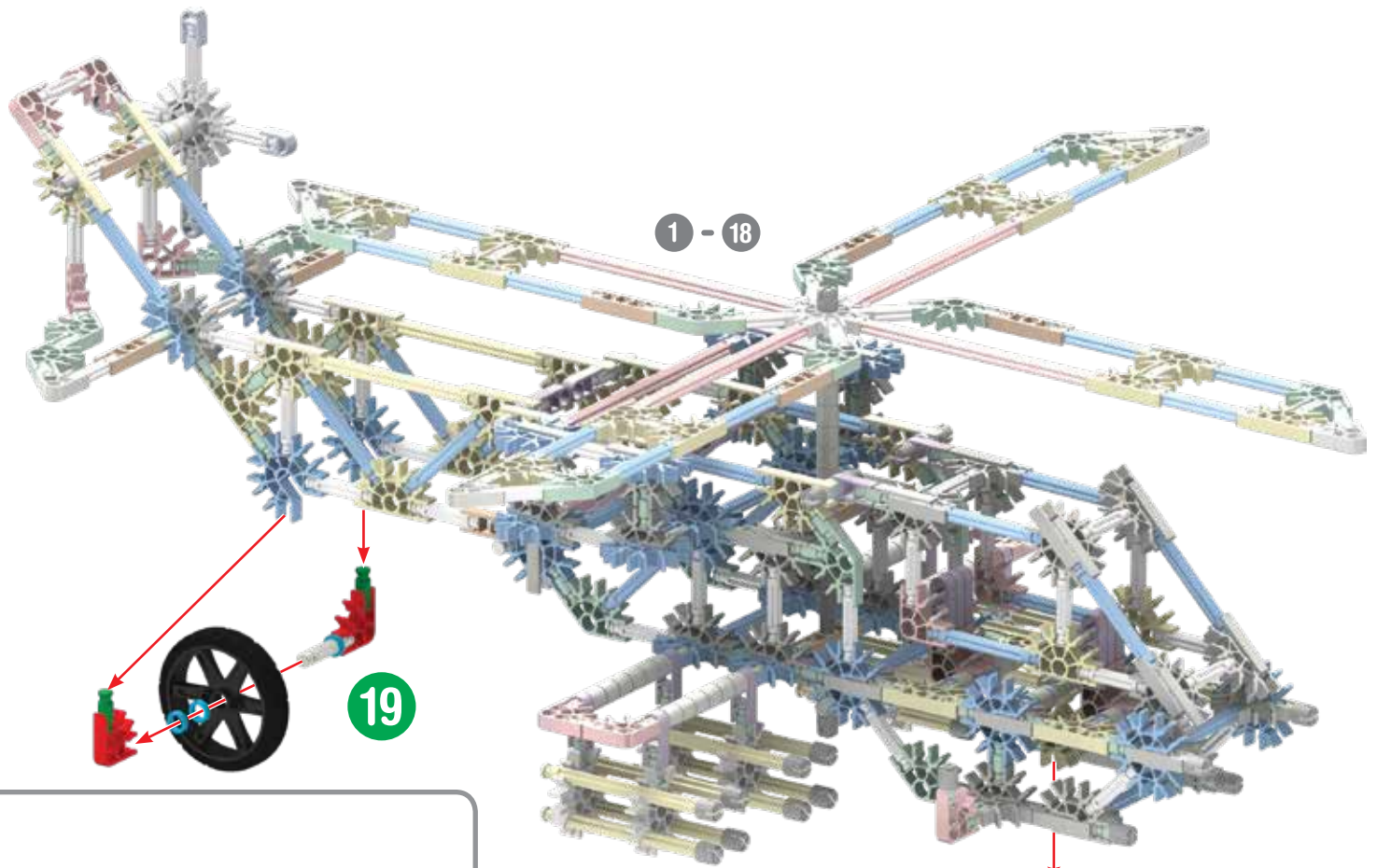

1 - 20

Blimp Dirigeable

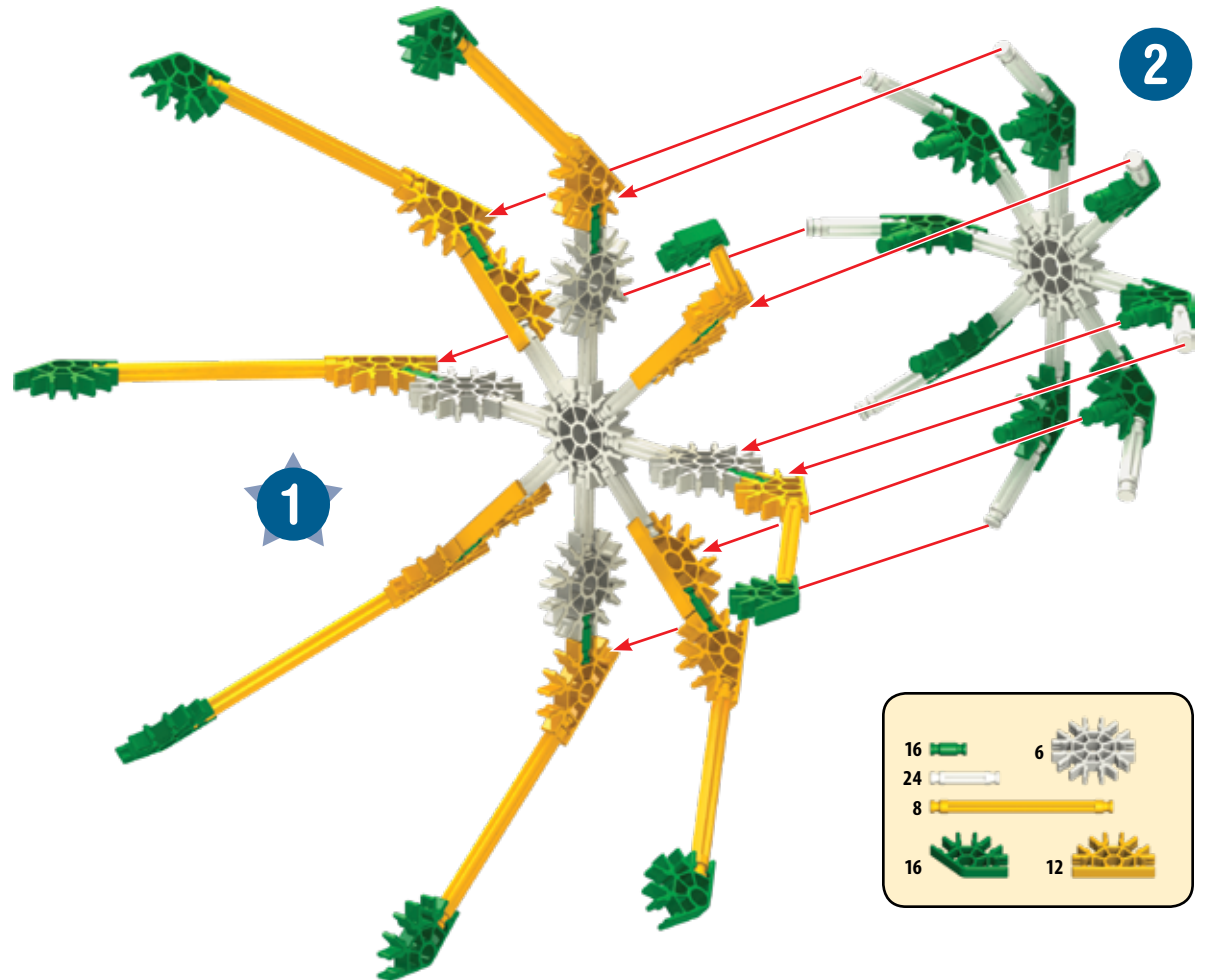
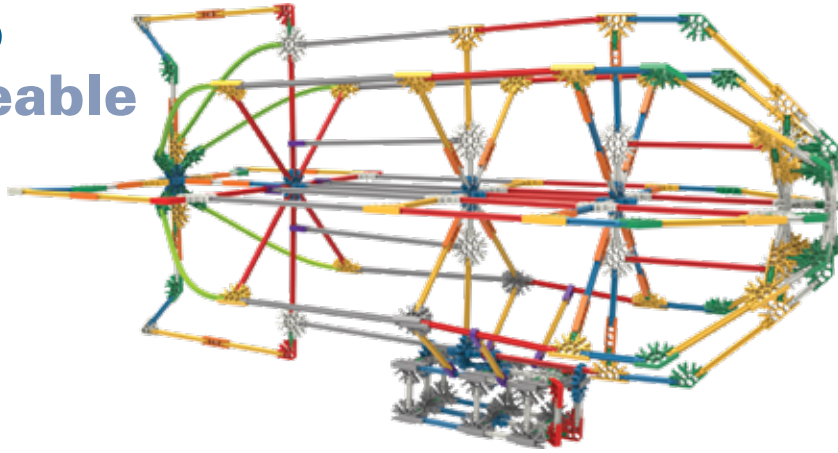

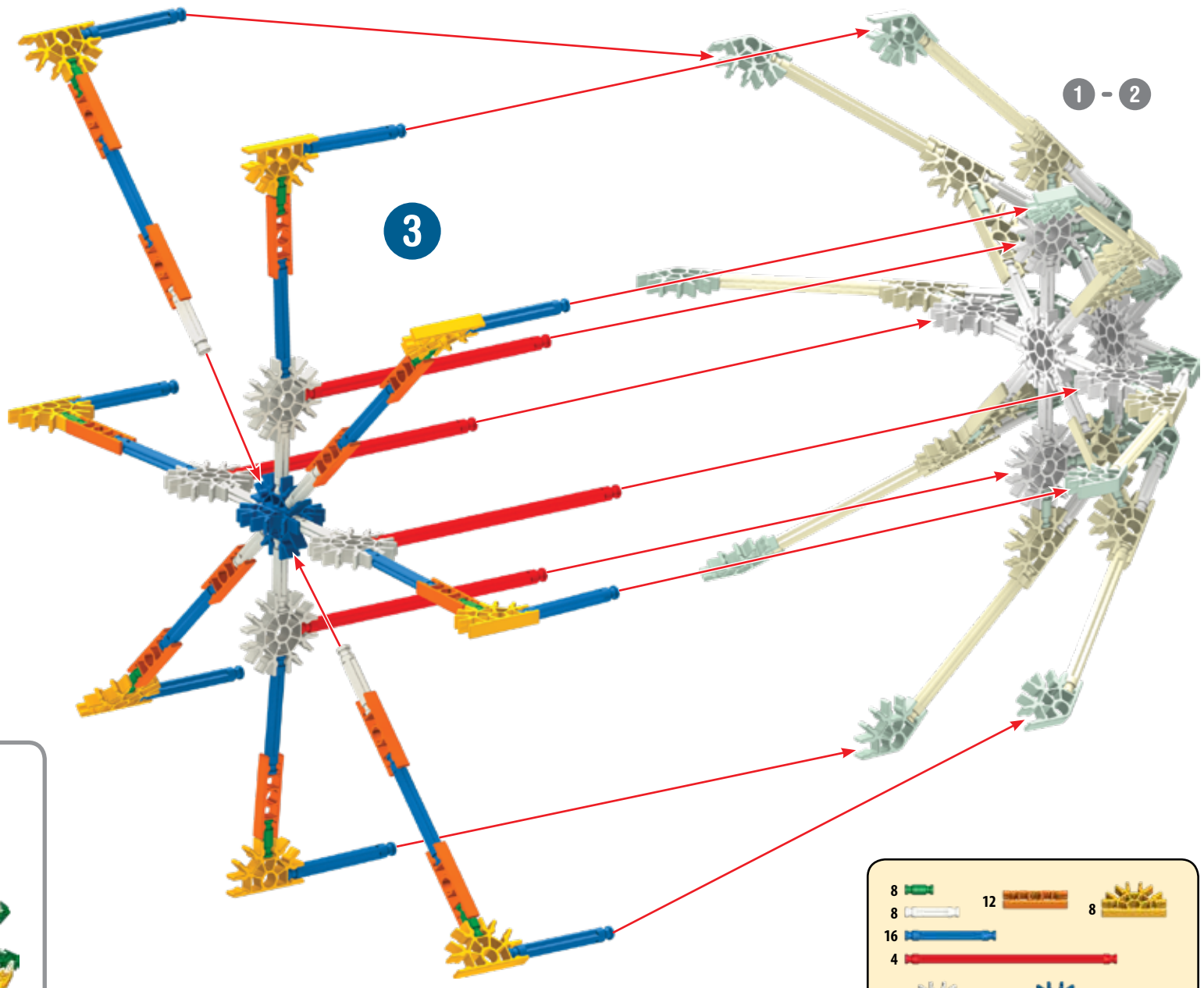

1 - 2

3

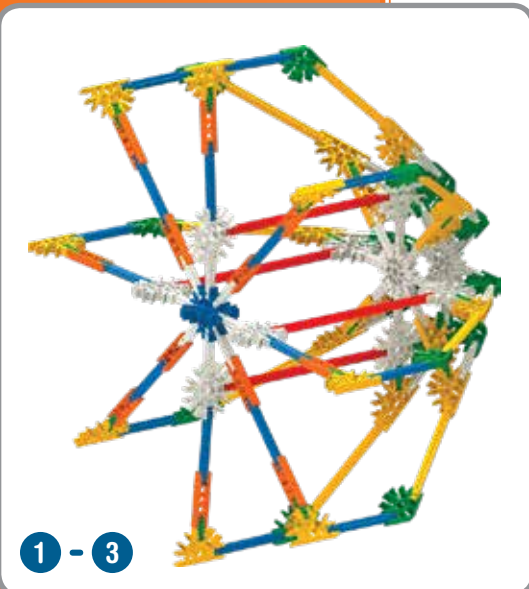

1 - 3

8		12		8	
8					
16					
4					
4		2			

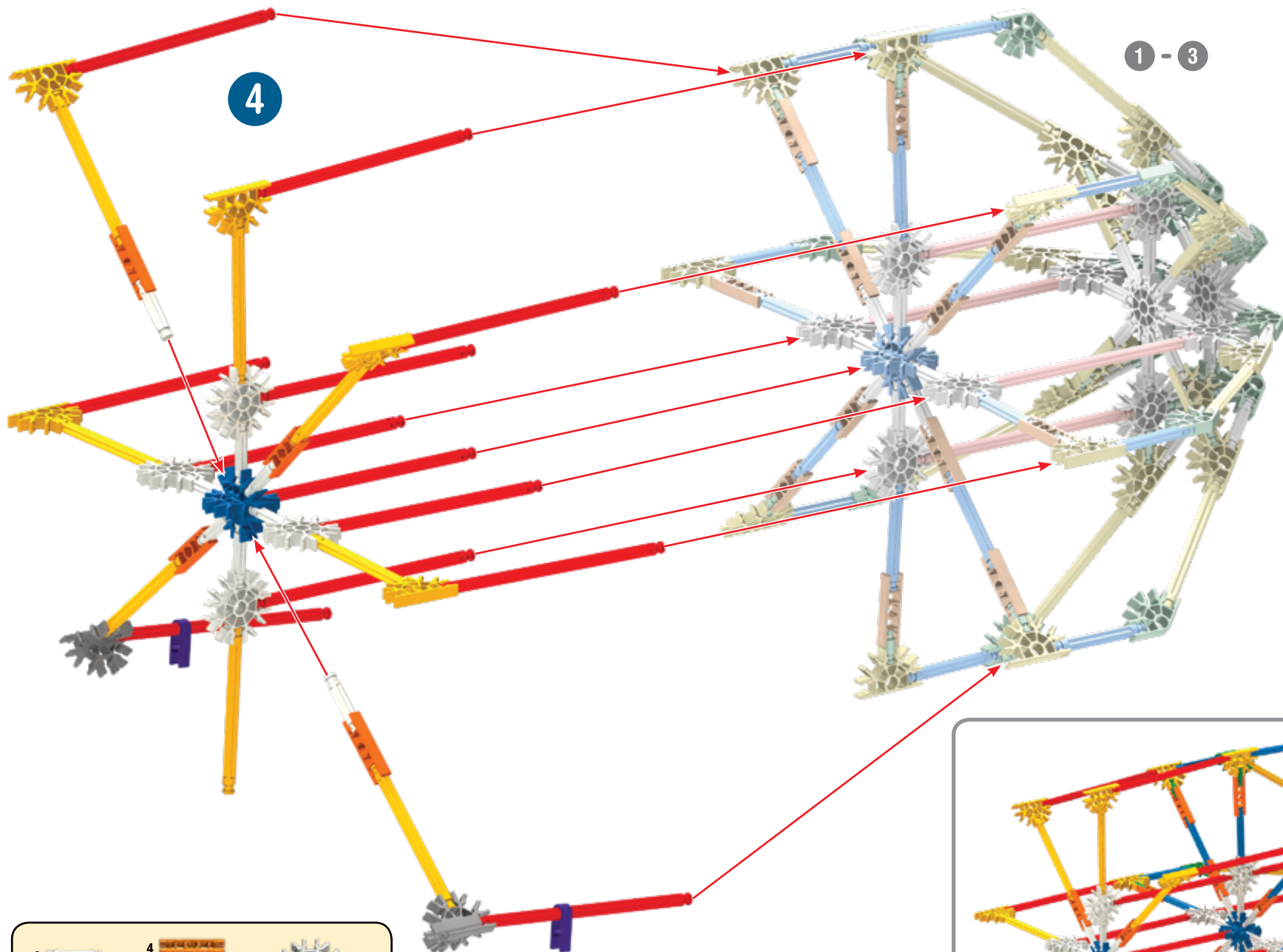

- | | | | | | |
|----|--|---|--|---|--|
| 8 | | 4 | | 4 | |
| 8 | | | | | |
| 12 | | | | | |
| 5 | | 4 | | 2 | |
| 2 | | | | | |

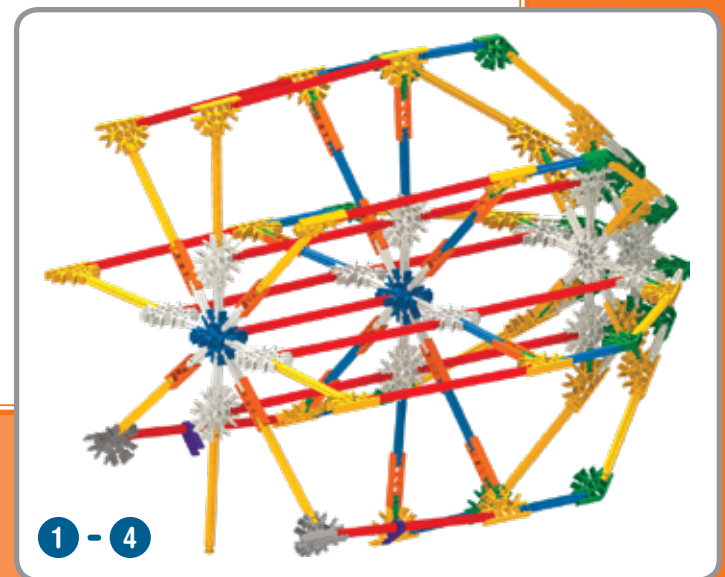

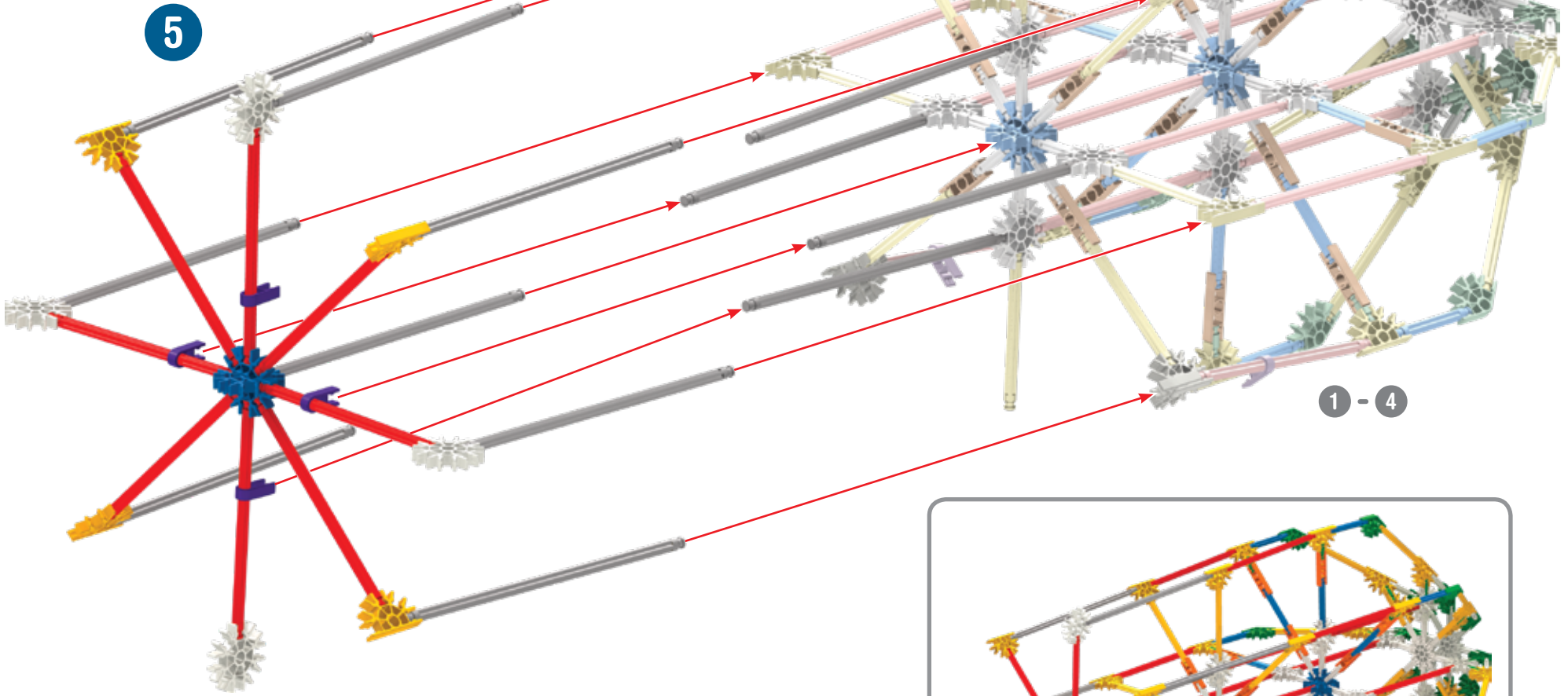
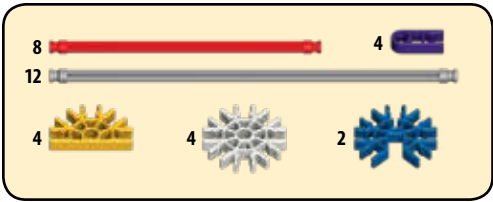

1 - 4

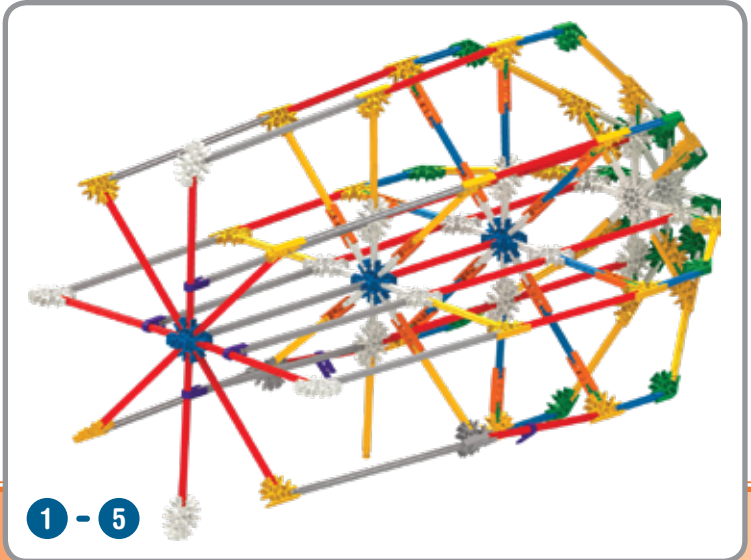

1 - 5

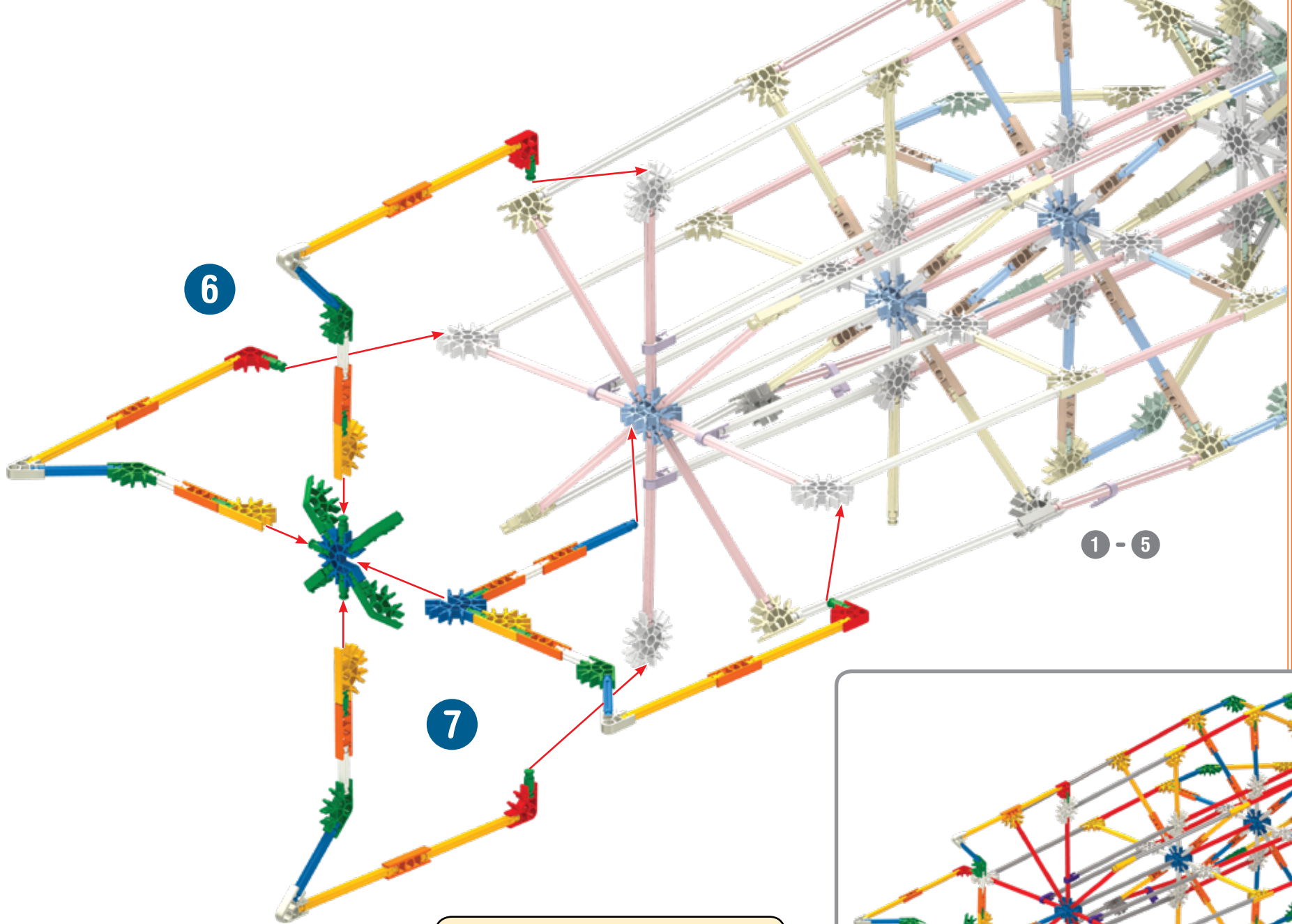

6

7

1 - 5

17		10		2	
5					
5					
8					
4		4		8	
				4	

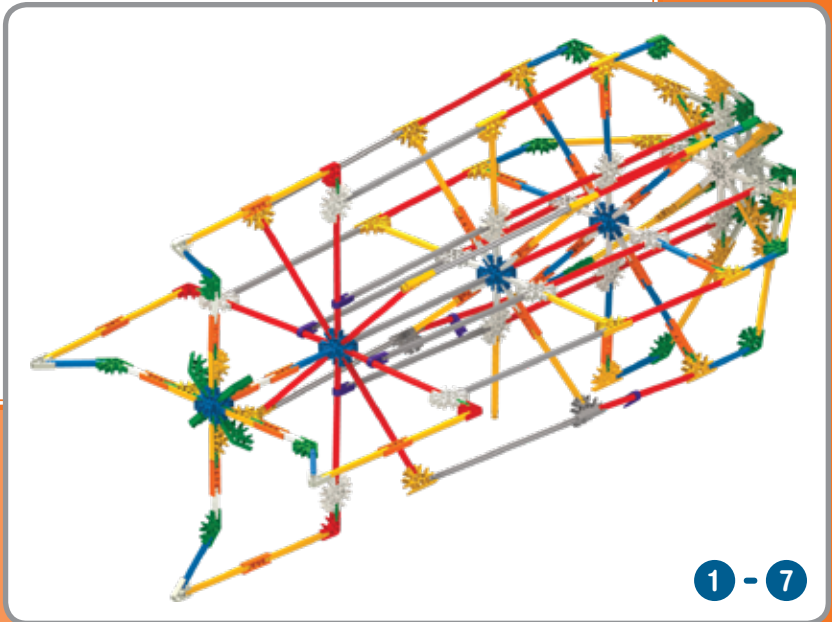

1 - 7

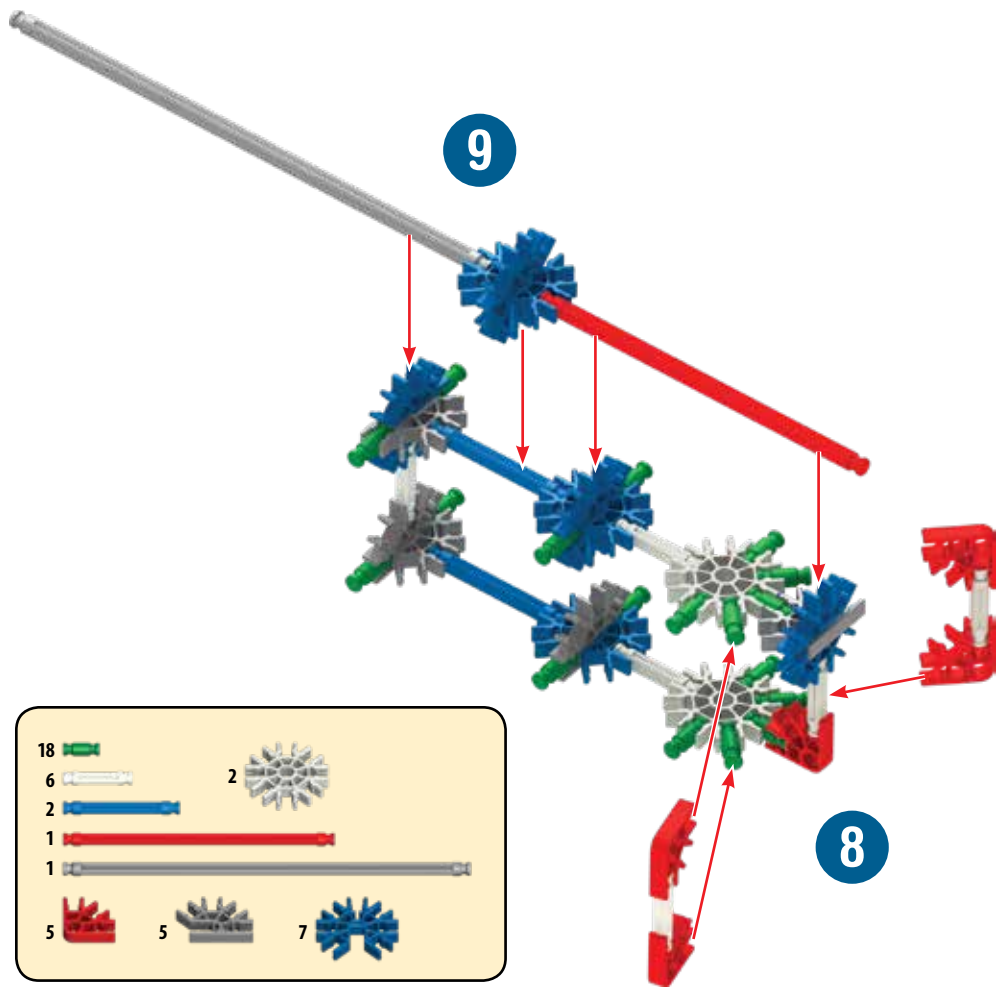

- | | | | |
|----|--|---|--|
| 18 | | | |
| 6 | | 2 | |
| 2 | | | |
| 1 | | | |
| 1 | | | |
| 5 | | 5 | |
| | | 7 | |

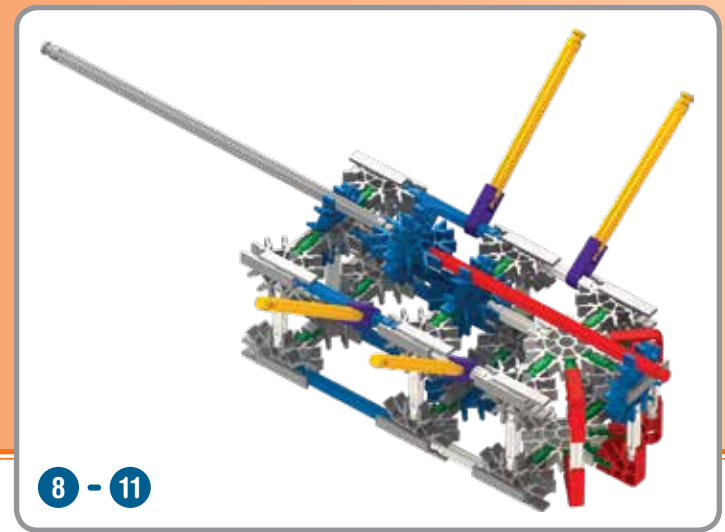
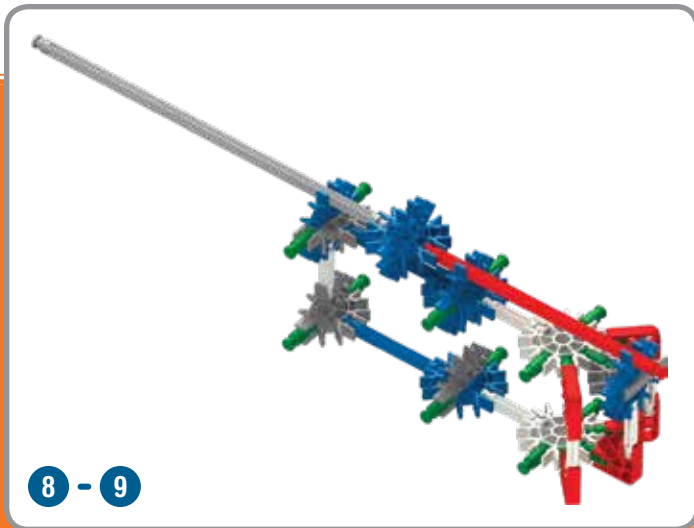

- | | | | |
|----|--|----|--|
| 10 | | | |
| 4 | | | |
| 4 | | | |
| 4 | | 24 | |

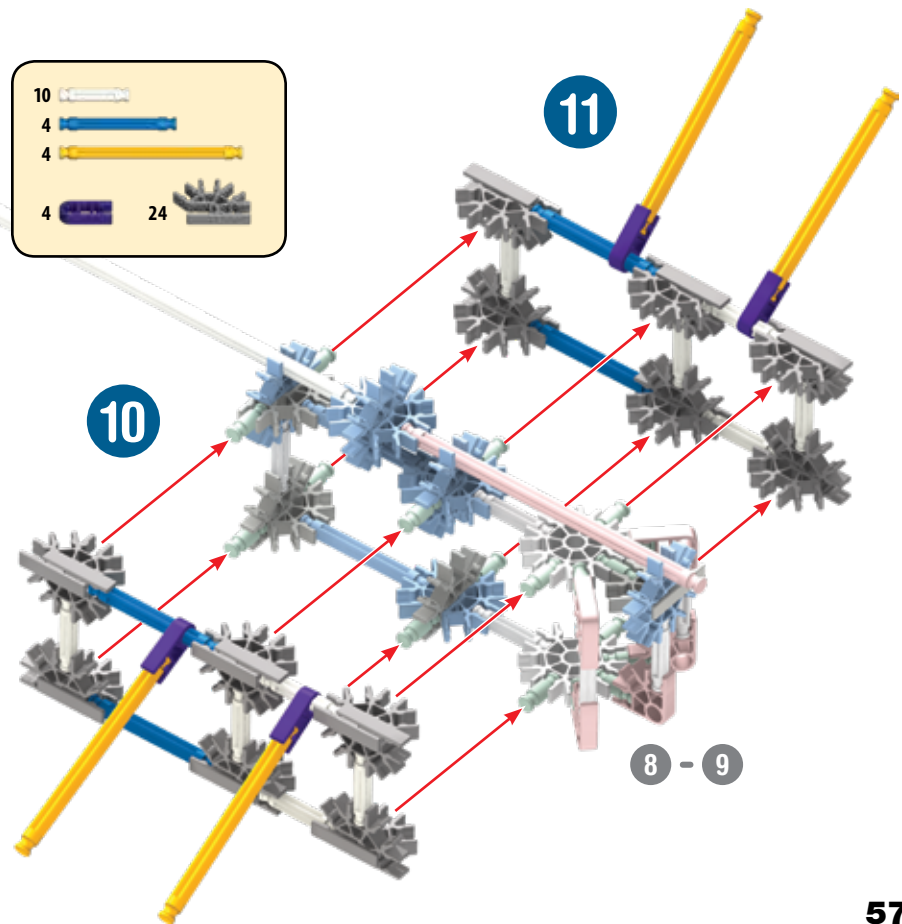

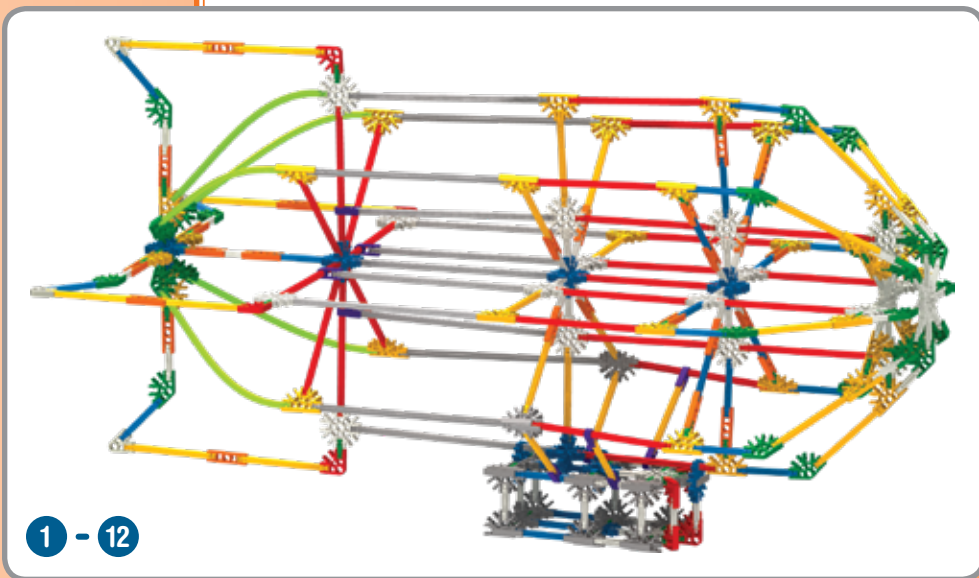
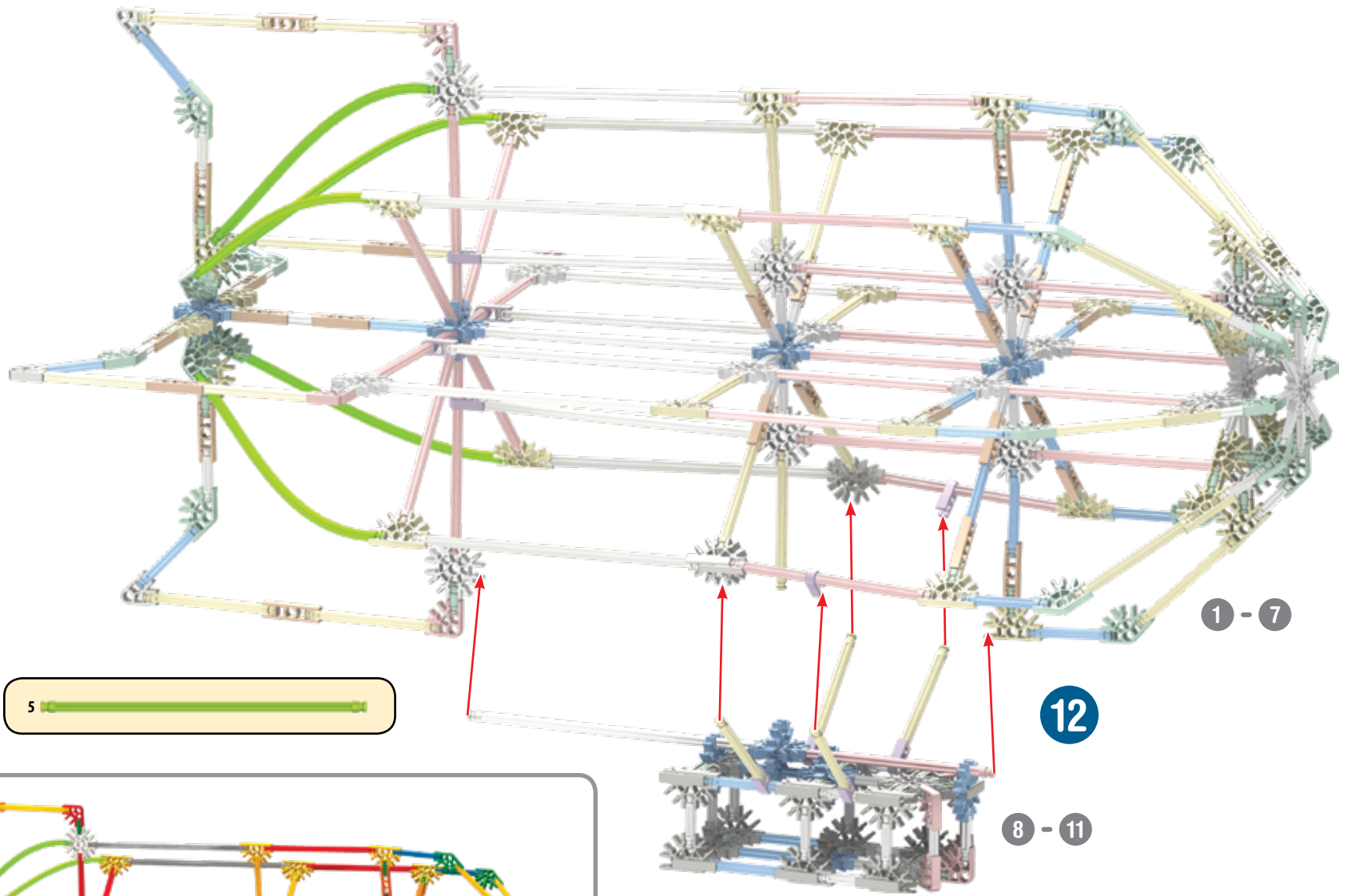

(ES) Español

Lista de Piezas

Antes de comenzar a construir, compare las piezas de su juego con las que se enumeran aquí. Si falta algo, visite www.Basicfun.com para contactarnos. ¡Estamos aquí para ayudarte!

Esenciales de construcción K’NEX Empieza a Construir

Para comenzar tu modelo, busca el 1 y sigue los números. Cada pieza tiene su propia forma y color. Simplemente mira los dibujos, busca las piezas correspondientes en tu juego y después conéctalas. Mientras construyes, trata de colocar tu modelo en la misma dirección que se muestra en las instrucciones. Los colores desteñidos muestran que esta sección ya está construida. Conecta las nuevas secciones en los lugares señalados por las flechas. Las nuevas piezas que agregues estarán en colores vivos.

Conectores

Hay conectores azules y plateados con ranuras largas especiales. Se enganchan deslizándose como ves en los dibujos. Conecta estas piezas empujándolas hasta que oigas “clic”.

Espaciadores

Hay lugares en tu modelo donde tendrás que agregar Espaciadores azules y plateados. Cerciórate de usar el color correcto y cuéntalos con cuidado.

Varillas Flexibles

Una varilla flexible es una Varilla que se puede doblar para formar curvas. Serán más fáciles de conectar a tu modelo si primero las doblas hacia atrás y hacia adelante.

(DE) Deutsch

Teileliste

Bevor du mit dem Bauen anfängst, solltest du prüfen ob die Teile in deinem Bausatz mit denen auf dieser Teileliste übereinstimmen. Wenn etwas fehlt, besuchen Sie bitte www.Basicfun.com, um uns zu kontaktieren. Wir sind hier, um dir zu helfen!

Grundlegende Bauanleitungen für K’NEX

Los geht’s mit dem Bauen

Um mit dem Bauen deines Modells zu beginnen, suche die Nummer 1 und folge den laufenden Nummern. Jedes Teil hat seine eigene Form und Farbe. Schau dir einfach die Abbildungen an, such die Teile in deinem Bausatz, die so aussehen wie das, was du auf der Abbildung siehst und steck sie ineinander. Versuche, dein Modell beim Zusammenbauen so zu orientieren, dass es in die gleiche Richtung weist, wie es in den Anleitungen beschrieben und gezeigt wird. Blasse Farben weisen darauf hin, dass dieser Streckenabschnitt bereits zusammengebaut ist.

Abstandsstücke

An manchen Stellen in deinem Modell musst du Abstandsstücke einbauen. Achte darauf, die richtige Farbe und Anzahl von Abstandsstücken wie in der Anleitung gezeigt zu verwenden.

Verbindungsstücke

Blaue und silberfarbene verbindungsstücke haben besonders lange Schlitze. Wie du vauf der Abbildung sehen kannst, lassen sie sich ineinander schieben. Achte beim Aneinanderfügen dieser Teile darauf, dass du ein Klickgeräusch hörst. Erst dann sind die Teile fest miteinander verbunden.

Flexi-Laschen

Eine Flexi-Lasche ist eine Lasche, die du zu einer Kurve zurechtbiegen kannst. Sie lassen sich leichter an dein Modell anschließen, wenn du sie mehrmals hin- und herbiegst, um sie flexibler zu machen, bevor du sie das erste Mal benutzt.

(IT) Italiano

Elenco delle parti

Prima di cominciare a costruire, accertati di confrontare le parti che sono nel tuo set con l’elenco delle parti qui. Se manca qualcosa, visitare www.Basicfun.com per contattarci. Siamo qui per aiutarvi!

Istruzioni di base per costruire con K’NEX

Comincia a costruire

Per iniziare il modello, cerca il numero 1 e segui i numeri. Ogni pezzo ha una sua forma e un suo colore. Guarda la figura, trova i pezzi corrispondenti nel set e mettili insieme. Cerca di tenere il modello nella stessa direzione della figura e in tal modo sarà più semplice attaccare i pezzi nei posti giusti. I colori spenti ti dicono che questa sezione è già stata costruita. Dovrai collegare la nuova sezione al punto indicato dalla punta della freccia.

Connettori

È molto importante posizionare i connettori blu e argento in una specifica direzione. Presta molta attenzione alle istruzioni e posiziona i connettori orizzontalmente o verticalmente proprio come illustrato. Spingi con forza fino ad udire un clic.

Spaziatori

Ci sono punti nel tuo modello a cui dovrai aggiungere spaziatori blu e argento. Accertati si contarli attentamente.

Flexi-stangen

Een Flexi-stangen is een stang die kan gebogen worden om bochten of curves te maken. Ze maken zich gemakkelijker vast aan je model wanneer je ze eerst een paar keer heen en weer buigt.

(PT) Portuguêsê

Lista de peças

Antes de iniciares a construção, certifica-te de que comparas as peças do teu conjunto com a lista das peças aqui. Se alguma coisa estiver faltando, por favor visite www.Basicfun.com para nos contatar. Estamos aqui para ajudá-lo!

Instruções básicas para montar o K’NEX

Inicia a construção

Para começar o teu modelo, procura o 1 e segue os números. Cada peça tem a sua própria forma definida e cor. Basta simplesmente olhares para a ilustração, procurar as peças

do teu jogo correspondentes às que estás a ver e, em seguida, conectar umas nas outras. Enquanto estás a montar as peças, tenta manter o teu modelo na mesma direção, conforme mostrado na ilustração, para assim ligares as peças correctamente. As cores desbotadas indicam que esta secção já está montada. Passarás então a fazer a conexão da nova secção no local indicado pelas setas.

Conectores

É muito importante que posiciones os conectores azuis e cor de prateados numa direção específica. Presta muita atenção às instruções e coloca estes conectores horizontal ou verticalmente, exactamente conforme se mostra nas ilustrações. Junta as partes simultaneamente e com firmeza até ouvires um “estalido”.

Espaçadores

Existirão certos pontos no teu modelo que necessitam a colocação de espaçadores azuis e prateados. Assegura-te que os contas cuidadosamente.

Varetas flexíveis

Uma vareta flexível é uma vareta que podes dobrar para formar curvas. Para montares no teu modelo, será mais fácil se dobrares primeiro a vareta para trás e para a frente.

(NL) Nederlands

Onderdelenlijst

Voor je begint te bouwen, vergewis je ervan de onderdelen in je geheel na te gaan met de onderdelenlijst hier. Als er iets ontbreekt, bezoek dan www.Basicfun.com om contact met ons op te nemen. We zijn er om u te helpen!

Basisstappen voor K’NEX bouwen Begin te bouwen

Om met je model te beginnen, vind eerst het nummer 1 en volg de nummers. Elk stuk heeft zijn eigen vorm en kleur. Kijk gewoonweg naar de afbeeldingen, vind de overeenstemmende stukken terug in je geheel en maak ze aan mekaar vast. Tracht je model in dezelfde richting te plaatsen als de aanwijzingen terwijl je bouwt en monteert. De vervaagde kleuren duiden aan dat dit deel reeds is opgebouwd. Gelieve het nieuwe deel vast te koppelen op de plaats aangeduid door de pijlen.

Koppelstukken

Er zijn blauwe en zilveren koppelstukken met speciale lange gleuven. Ze schuiven in mekaar zoals je kunt zien op de afbeeldingen. Duw deze onderdelen in mekaar tot je een “klik” hoort.

Tussenstukken

In je model zijn er plaatsen waar blauwe en zilveren tussenstukken moeten toegevoegd worden. Verzeker je ervan de juiste kleur te gebruiken en tel ze zorgvuldig.

Flexi-stangen

Een Flexi-stangen is een stang die kan gebogen worden om bochten of curves te maken. Ze maken zich gemakkelijker vast aan je model wanneer je ze eerst een paar keer heen en weer buigt.

For instructions of these models go to www.knex.com/instructions and enter code **12605**.

Pour les instructions de ces modèles vont à www.knex.com/instructions et entrez dans le code **12605**.

Ya que las instrucciones de los estos modelos van a www.knex.com/instructions y introducir el código **12605**.

Für Anweisungen dieser Modelle gehen sie zu www.knex.com/instructions und geben sie Code **12605** ein.

Per istruzioni di questi modelli vai a www.knex.com/instructions e inserire il codice **12605**.

Para obter instruções destes modelos vá em www.knex.com/instructions e digite o código **12605**.

Voor instructies van deze modellen naar www.knex.com/instructions en vul de code **12605**.











**100 MODEL IMAGINE
BUILDING SET**
**100 MODÈLE IMAGINE
JEU DE CONSTRUCTION**



**SCIENCE/SCIENCE
TECHNOLOGY/TECHNOLOGIE
ENGINEERING/INGÉNIERIE
ART & DESIGN/ART ET DESIGN
MATH/MATHÉMATIQUES***

basicfun.com

@knex

facebook.com/knex



* Juego inspirado
Inspiriertes Spiel
Ha ispirato il gioco
Inspirou o jogo
Geinspireerd spel

* Ciencia/Wissenschaft/
Scienza/Ciência/Wetenschap
Tecnología/Technologie/
Tecnologia/Tecnologia/
Technologie
Ingeniería/Ingenieurwesen/
Ingegneria/Engenharia/
Bouwkunde

Arte Y Diseño/Kunstdesign/
Arte E Design/Design de arte/
kunst En Ontwerp
Matemáticas/Mathematik/
Matematica/Matemática/
Wiskunde

100 Modelos
Modelles
Modelli
Modelo
Modellen

1-800-KID-KNEX (USA/Canada/États-Unis/EE.UU.). 2019 K'NEX, a Division of Basic Fun, Inc., 301 Yamato Road, Suite 4200, Boca Raton FL 33431, USA. K'NEX UK Ltd., 200 Brook Drive, Green Park, Reading, RG6 2UB England; K'NEX France, 24 rue du Quatre Septembre, 75002 Paris, France.

(EN) K'NEX and Steamagination are registered trademarks of Basic Fun, Inc. For customers outside the USA/Canada please contact your local distributor at www.knex.com/distributors

(FR) K'NEX et Steamagination sont des marques déposées de Basic Fun, Inc. Pour les clients en dehors du Canada et des États-Unis, veuillez contacter votre distributeur local que vous pouvez trouver sur www.knex.com/distributors

(ES) K'NEX y Steamagination son marcas registrada de Basic Fun, Inc. Para clientes fuera de los EE.UU. y Canadá, por favor póngase en contacto con su distribuidor local en www.knex.com/distributors

(EN) Product & colors may vary. Most models can be built one at a time.

(FR) Le produit et ses couleurs peuvent varier. Les différents modèles ne peuvent être construits qu'un par un.

(ES) El producto y los colores pueden variar. La mayoría de los modelos se pueden construir uno a la vez.

(DE) Produkte und Farben können abweichen. Die meisten Modelle können immer nur einzeln gebaut werden.

(IT) Prodotti e colori possono differire. La maggior parte dei modelli si può costruire autonomamente.

(PT) O produto e as cores podem variar. A maioria dos modelos pode ser montado um de cada vez.

(NL) Product en kleuren kunnen variëren. De meeste modellen kunnen uitsluitend een voor een worden gebouwd.

112605-V4-06/19