

# K'NEX®

COOL MACHINES™

13143

## POPPIN' WHEELIES

HIGH KICKIN' ROADSTERS!



**WARNING:**  
CHOKING HAZARD - Small Parts.  
Not for children under 3 years.

**AVERTISSEMENT:**  
DANGER D'ÉTOUFFEMENT - Pièces de petite taille.  
Ne pas donner aux enfants de moins de 3 ans.

**ATENCIÓN:**  
PELIGRO DE ASFIXIA - Por contener piezas pequeñas,  
no recomendable para niños menores de tres años.

**MOTORIZED &  
GEARED FOR  
ACTION!**



COLOR CODED BUILDING SYSTEM

# Congratulations!

**Y**ou have discovered K'NEX, the award winning construction system that lets you build and bring to life anything you can imagine.

Stretch your imagination. Make the most of your creativity. And have a ton of fun building, too.

Your set has everything you need to turn K'NEX parts into totally cool models. The instructions get you going, but the fun doesn't stop there. Design your own models! Make your own K'NEX world.

And check out the other great K'NEX Sets, with exciting themes and models for kids of all ages!

Visit the K'NEX Web site at [www.knex.com](http://www.knex.com).  
Questions? Call us at 1-800-KID-KNEX.

Félicitations ! Vous venez de découvrir K'NEX, un système de construction unique qui vous permettra de créer tout un monde imaginaire.

Laissez-vous guider par votre imagination, écoutez votre esprit créateur et amusez-vous à construire des modèles pendant des heures.

Vous trouverez dans cette boîte toutes les pièces et accessoires nécessaires pour créer de super modèles. Ces instructions ne sont qu'un exemple. Ne vous y limitez pas. Inventez d'autres modèles et bâtissez votre univers K'NEX !

N'oubliez pas non plus d'essayer les autres kits K'NEX qui vous proposeront encore plus de thèmes et de modèles pour enfants de tous les âges !

Visitez le site K'NEX au [www.knex.com](http://www.knex.com) ou appelez-nous au 1-800-KID-KNEX.

¡Enhorabuena! Has descubierto K'NEX, el sistema de construcción galardonado, que te permite construir y hacer que cobre vida todo aquello que puedas imaginarte.

¡Da rienda suelta a tu imaginación! ¡Sácale partido a tu creatividad! Y, de paso, ¡diviértete de lo lindo!

Este juego tiene todo lo que necesitas para crear, con las piezas K'NEX, los modelos más divertidos. Las instrucciones te muestran el camino, pero el juego no tiene límites.

¡Diseña tus propios modelos! ¡Crea tu propio mundo K'NEX!

Y no olvides que hay muchos otros sets K'NEX para niños de todas las edades, con temas y modelos que te encantarán.

Visita el sitio de K'NEX en la Web, [www.knex.com](http://www.knex.com), o llámanos al 1-800-KID-KNEX.

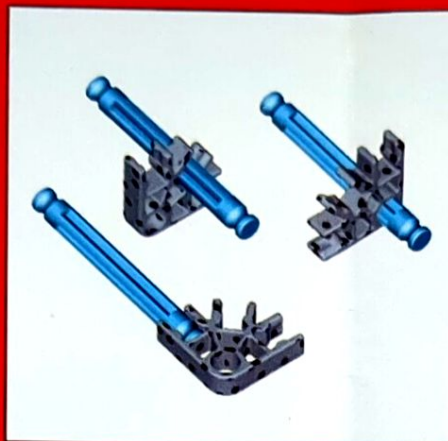

Each K'NEX piece has its own color and shape; match it to pieces in the picture instructions. Put pieces together exactly as pictures show. Be sure to put Rods in the correct slots of Connectors, so you have proper angles in your finished model.

Chaque pièce K'NEX a une couleur et une forme bien à elle. Faites correspondre et montez les pièces les unes sur les autres en suivant exactement les instructions illustrées. Assurez-vous de bien assembler les tiges dans les fentes des connecteurs afin d'obtenir des angles corrects une fois le modèle fini.

Assurez-vous de bien assembler les tiges dans les fentes des connecteurs afin d'obtenir des angles corrects une fois le modèle fini. Asegurarse de colocar las varillas en las ranuras correctas de los conectores, de modo que al terminar el modelo, los ángulos sean los adecuados.

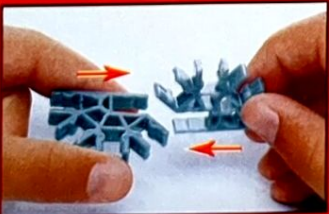
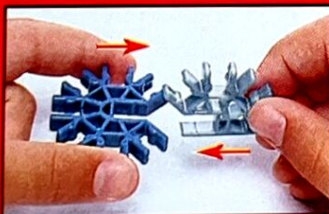
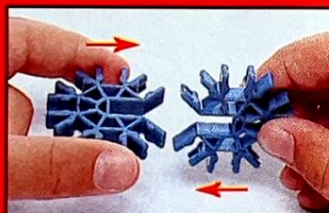

It's very important to position blue and silver Connectors in a specific direction. Pay close attention to the instructions, and position these Connectors horizontally or vertically exactly as they are shown. Push together tightly until you hear a "click".

Il est important de bien placer les connecteurs bleus et argentés dans le bon sens. Lisez attentivement les instructions et placez ces connecteurs horizontalement ou verticalement selon l'indication. Appuyez dessus en forçant légèrement jusqu'à ce que vous entendiez un dé clic.

Es muy importante colocar los conectores de color azul y plata en una dirección específica. Prestar mucha atención a las instrucciones y colocar estos conectores según se indica, ya sea horizontal o verticalmente. Para conectarlos, presionar hasta oír un "clic".

Faded colors indicate sections previously built; connecting points will be in full color.

Les couleurs plus claires indiquent les sections déjà construites. Les points de jonction sont indiqués en couleurs vives.

Los colores apagados indican secciones que ya han sido montadas anteriormente. Los puntos de conexión se indican con colores vivos.



**CAUTION:** Keep hands, face, hair, clothing and Power Cord away from all moving parts.

**ATTENTION:** Tenez toute pièce mobile à l'écart des mains, du visage, des cheveux, des vêtements et du cordon d'alimentation.

**PRECAUCIÓN:** Mantener las manos, cara, pelo, ropa y cable de alimentación alejados de todas las piezas móviles.

# POPPIN' WHEELIE

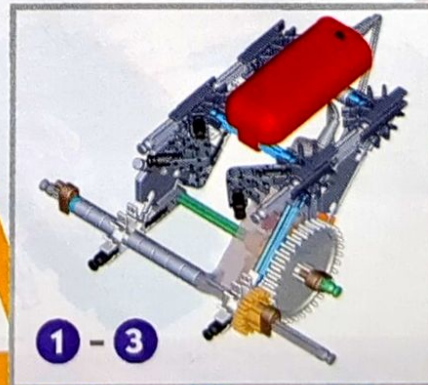
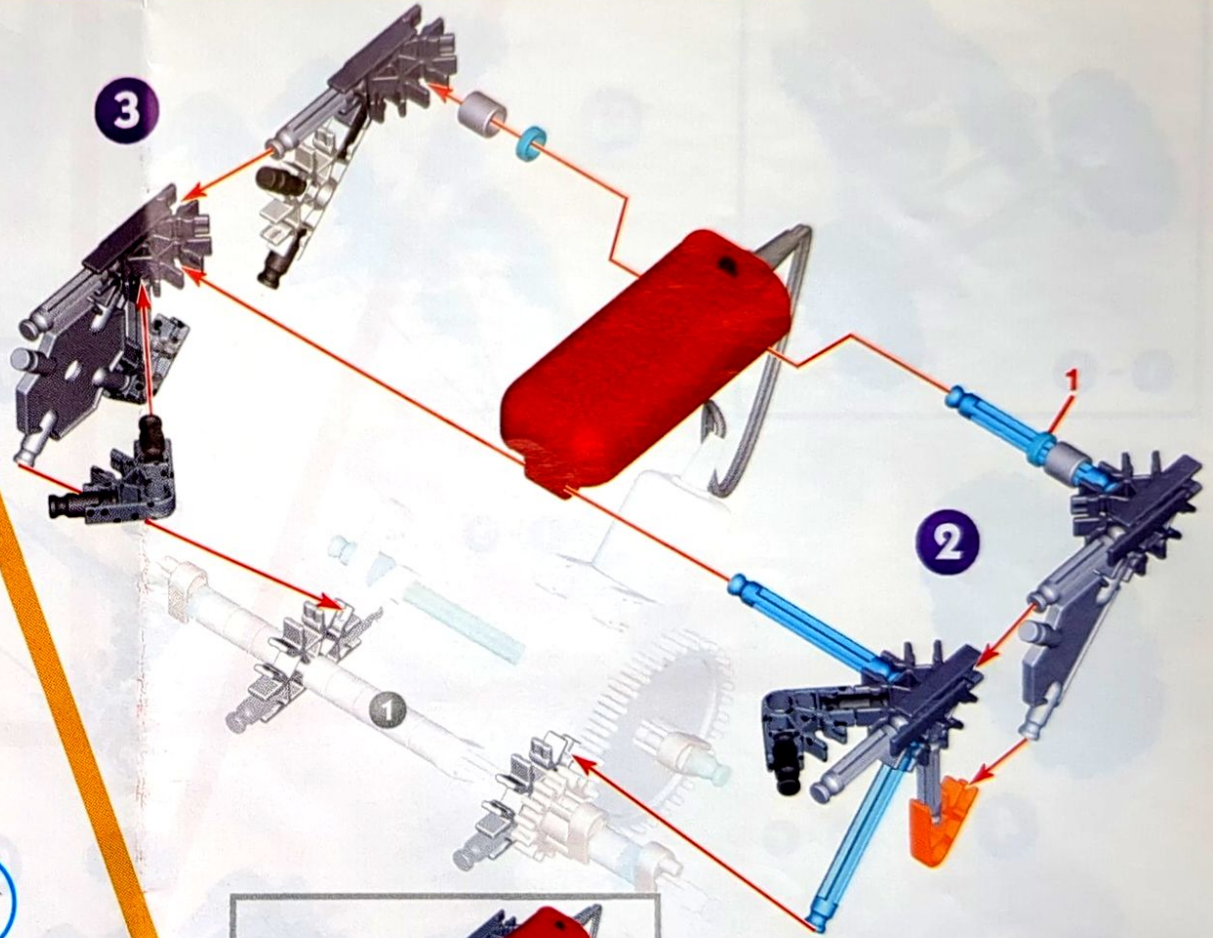
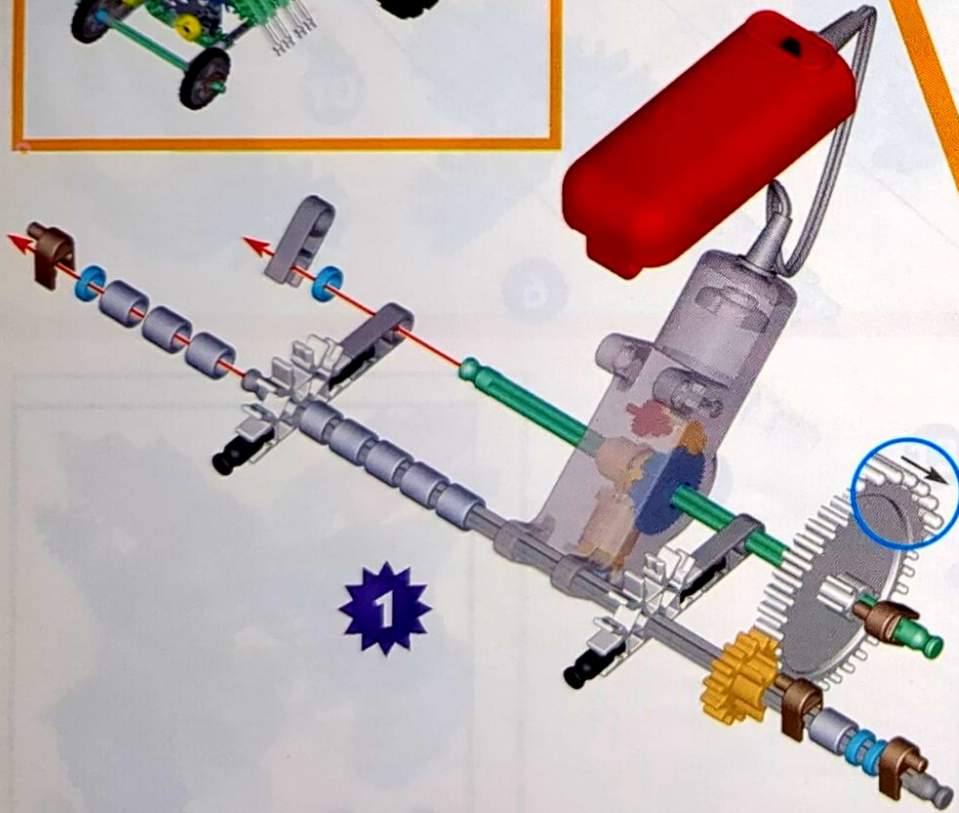
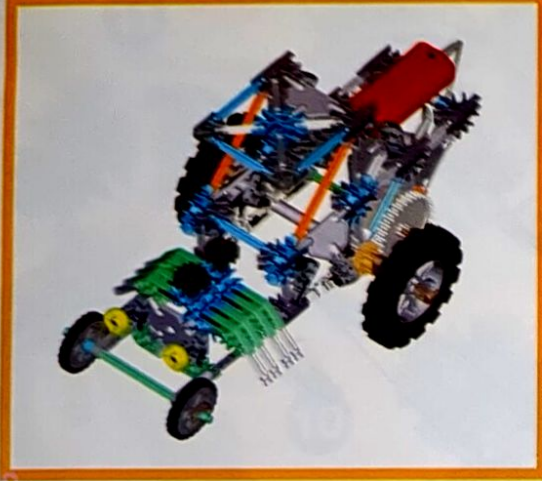

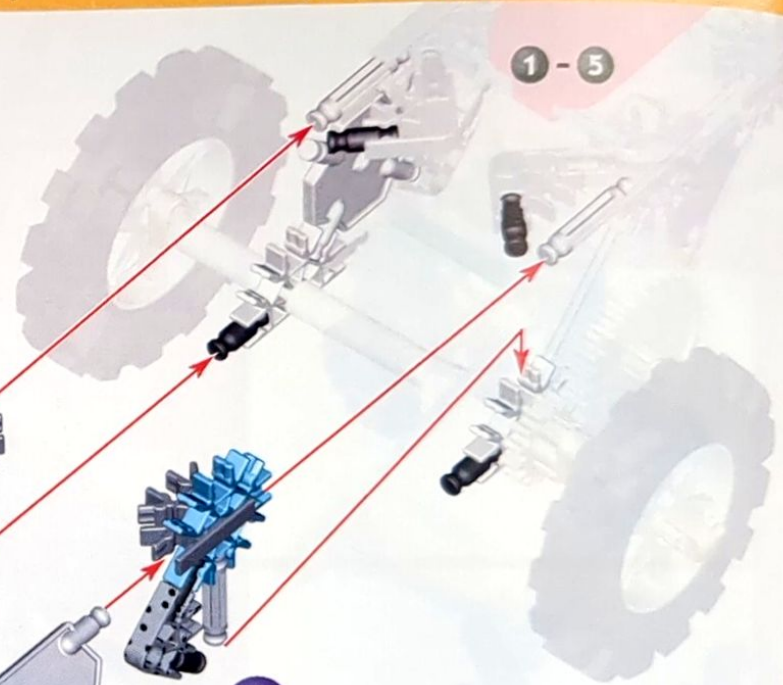
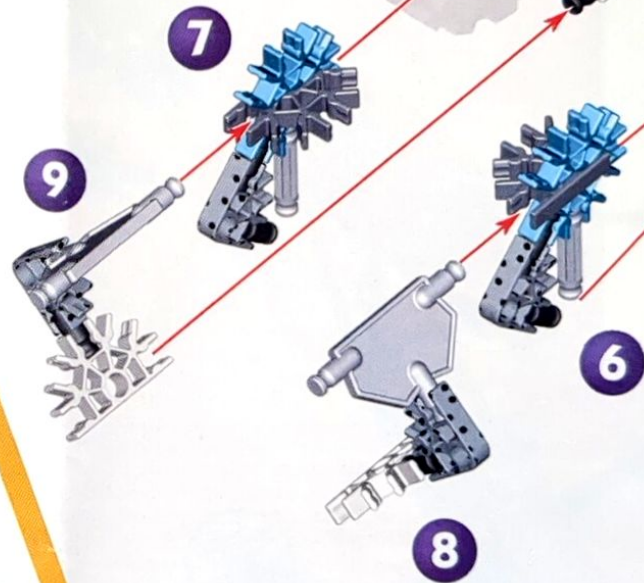
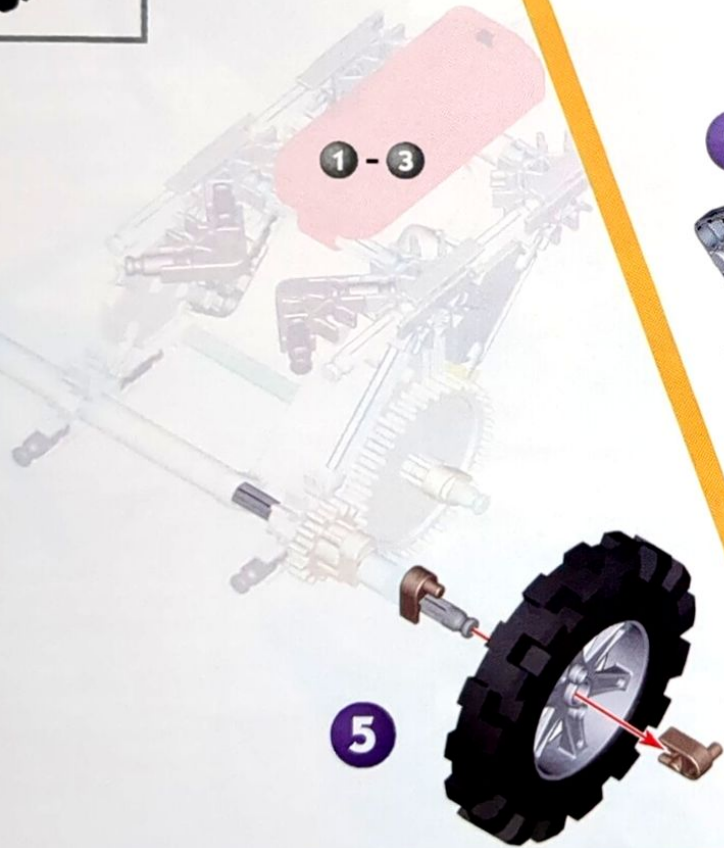
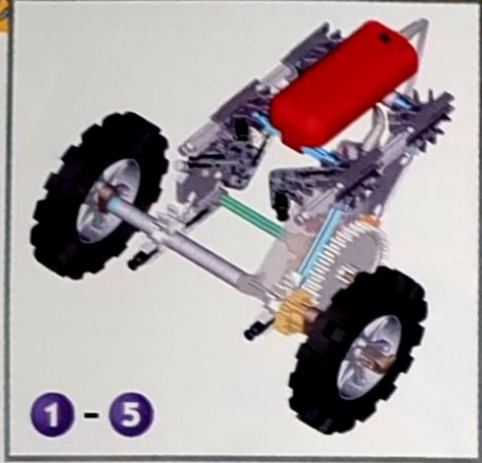

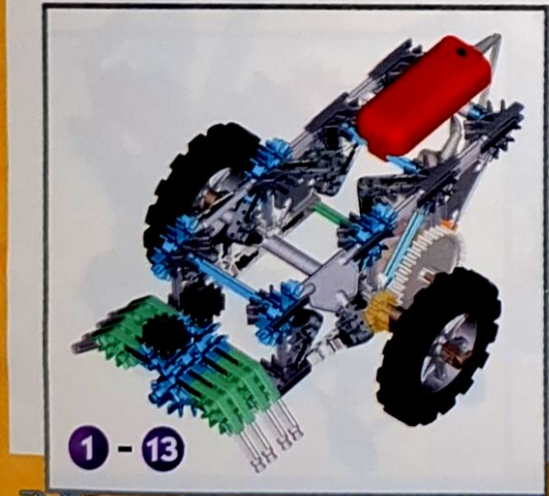
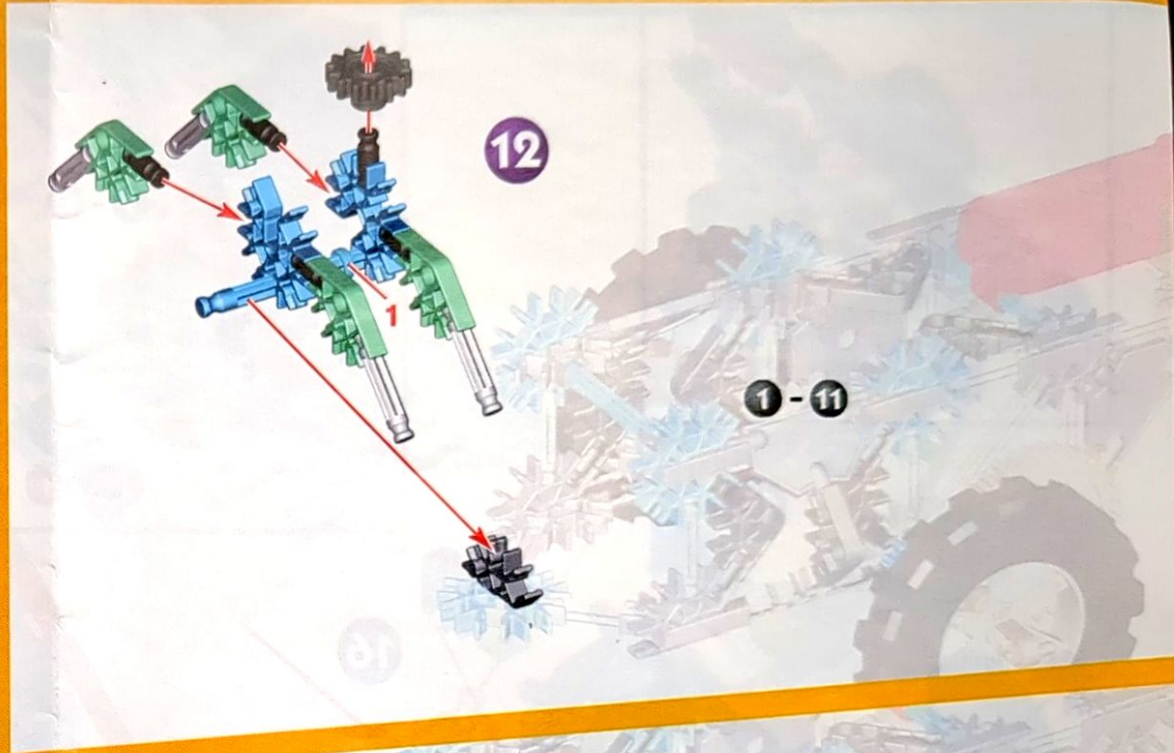
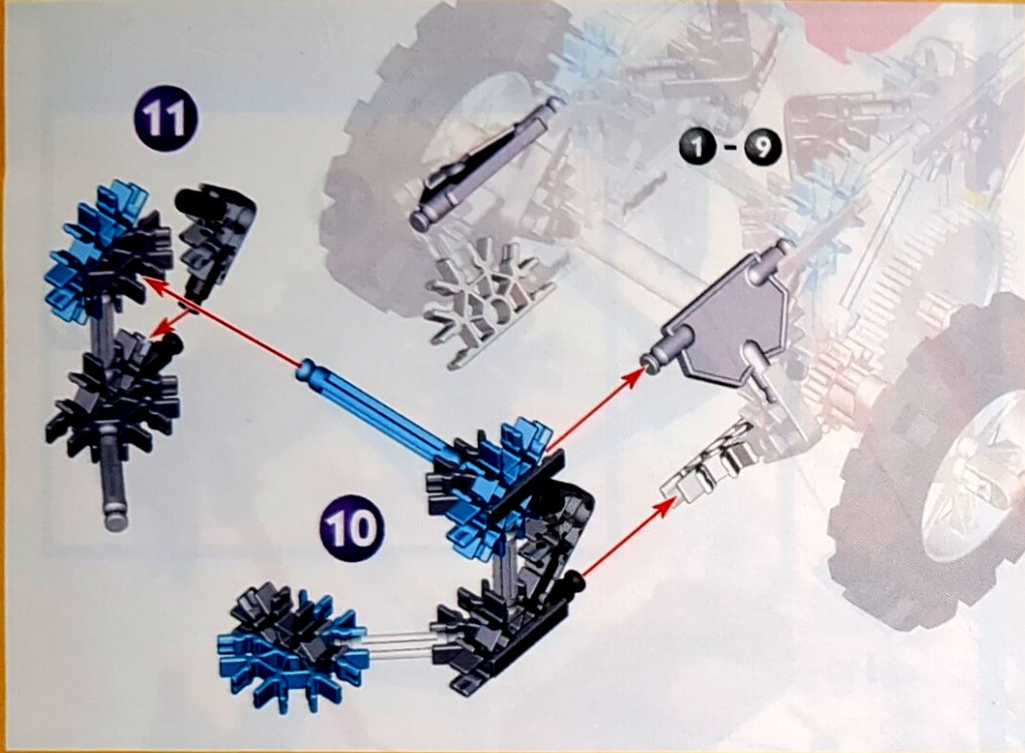

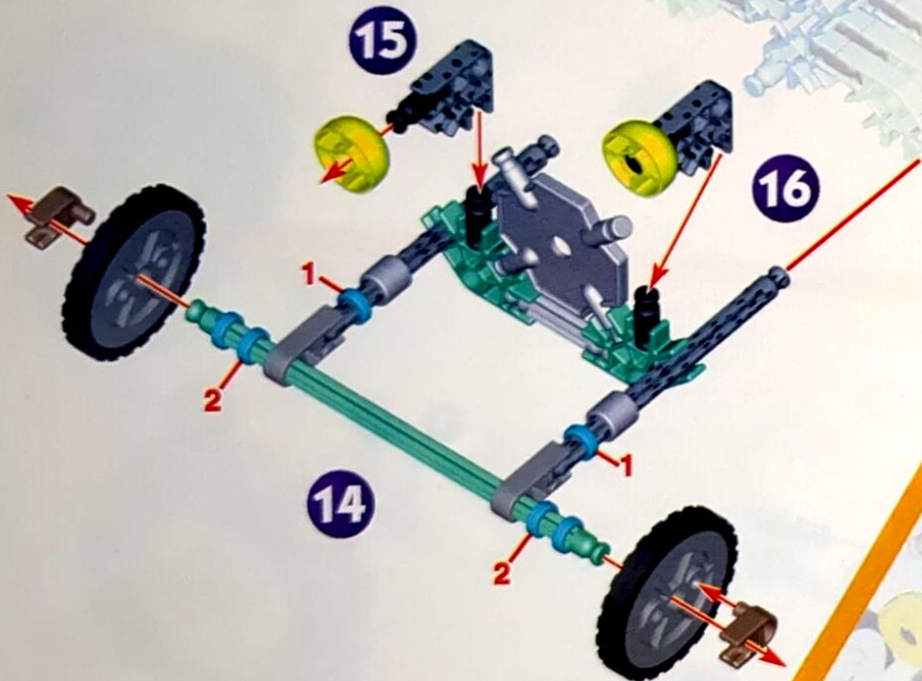
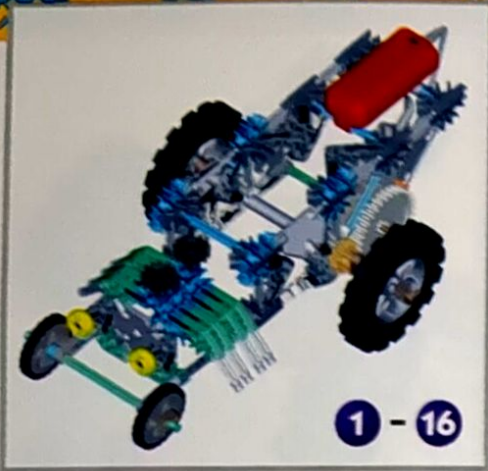

1 - 13

18

17

19

1 - 16



# VICKED WHEELIE

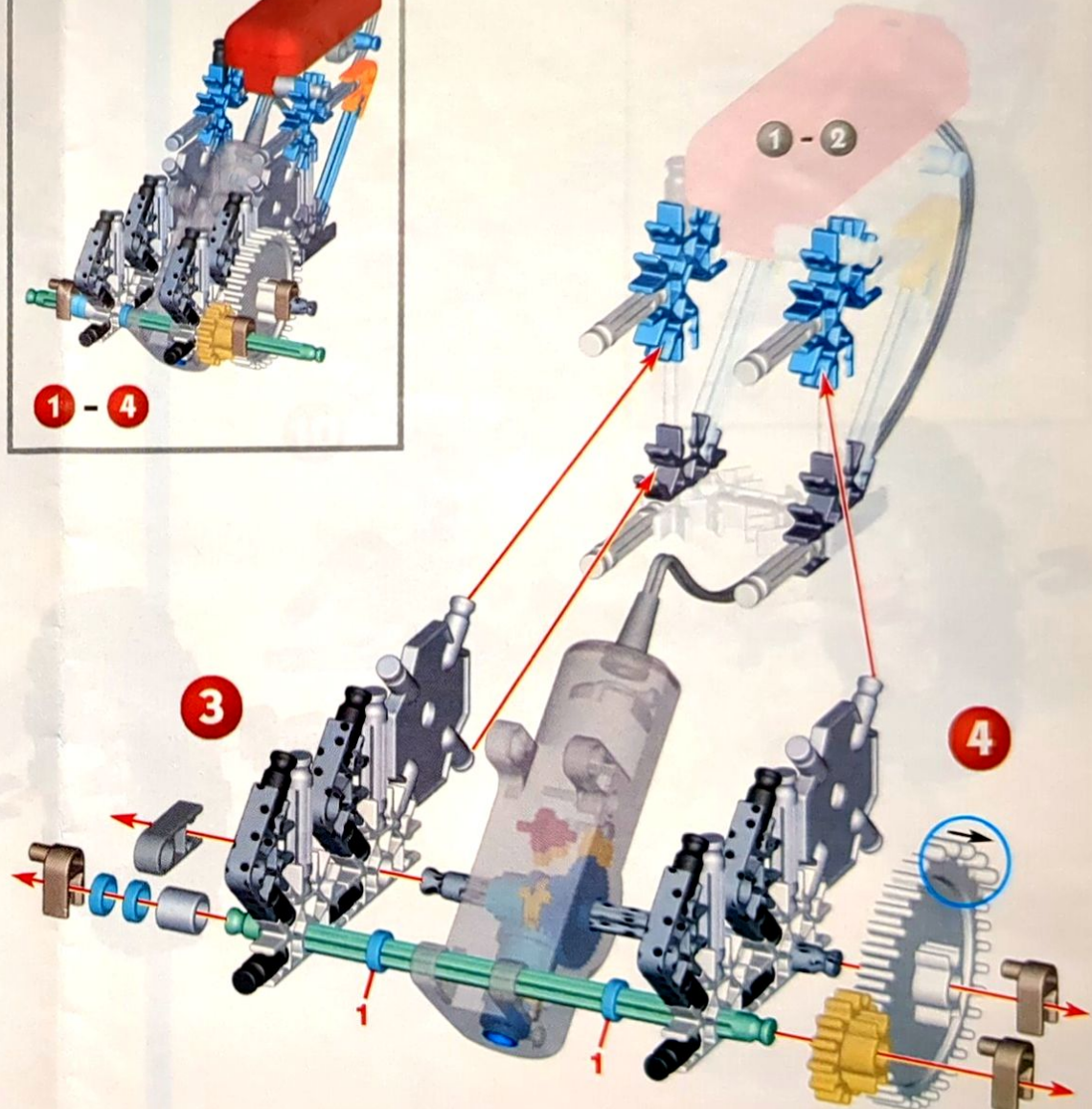
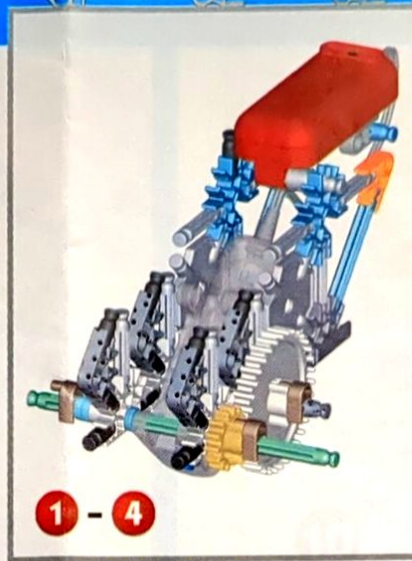
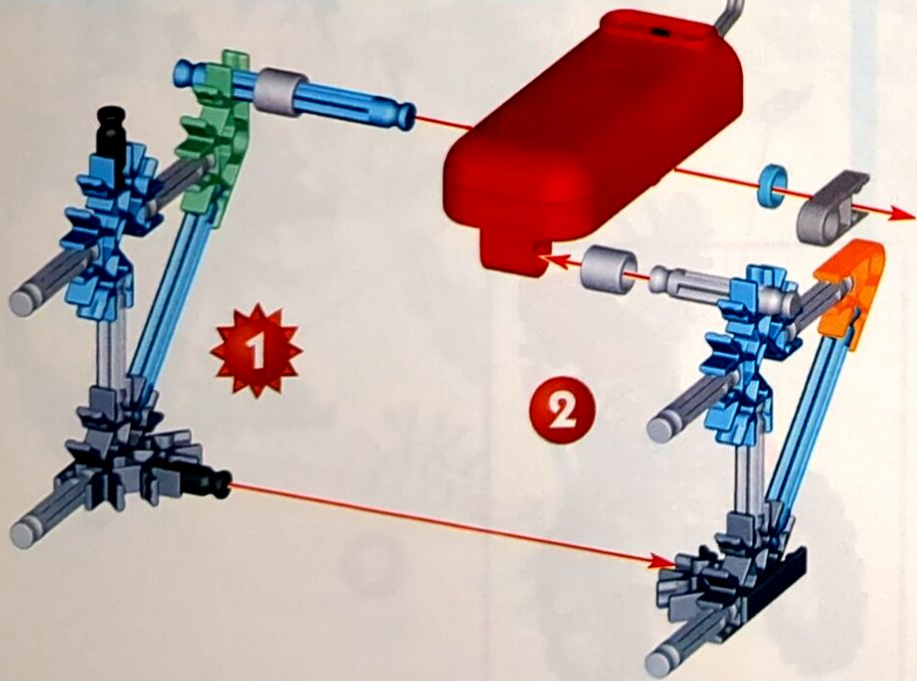

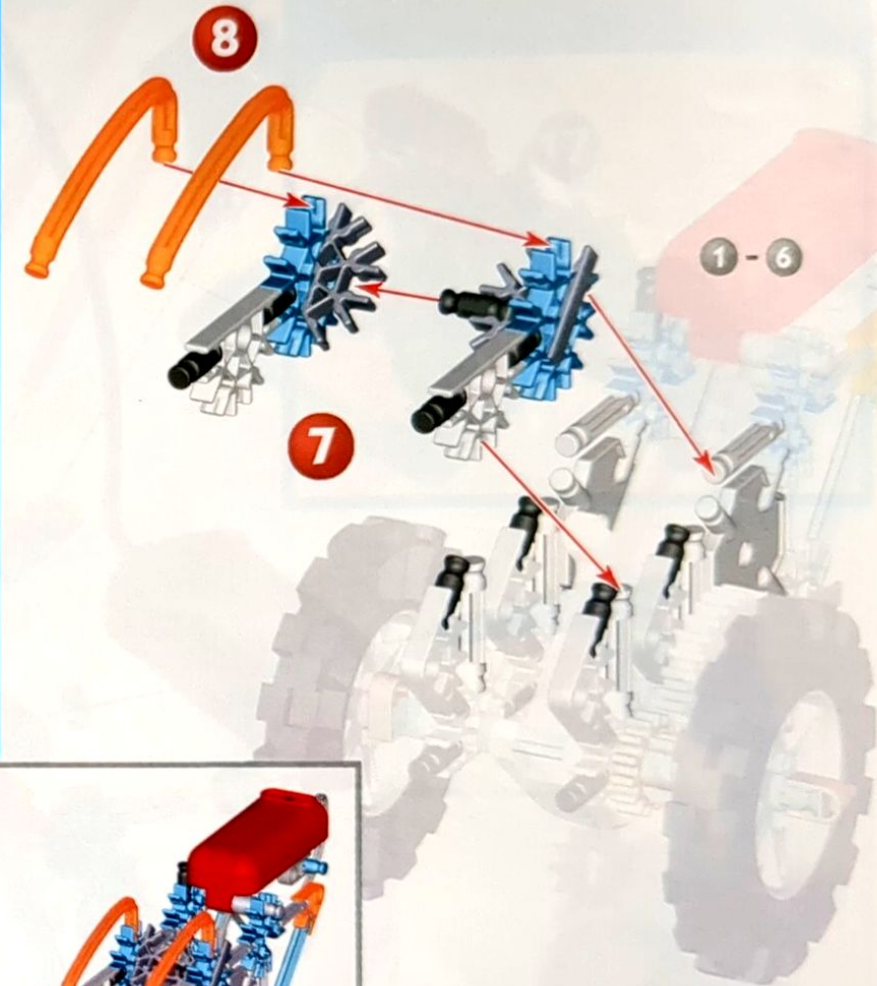
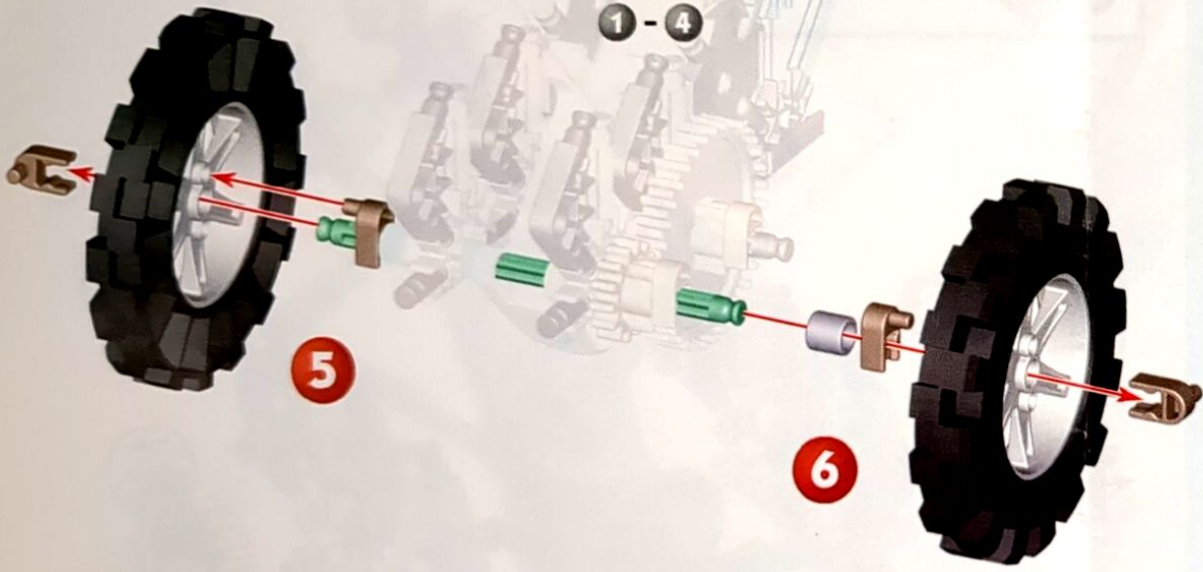

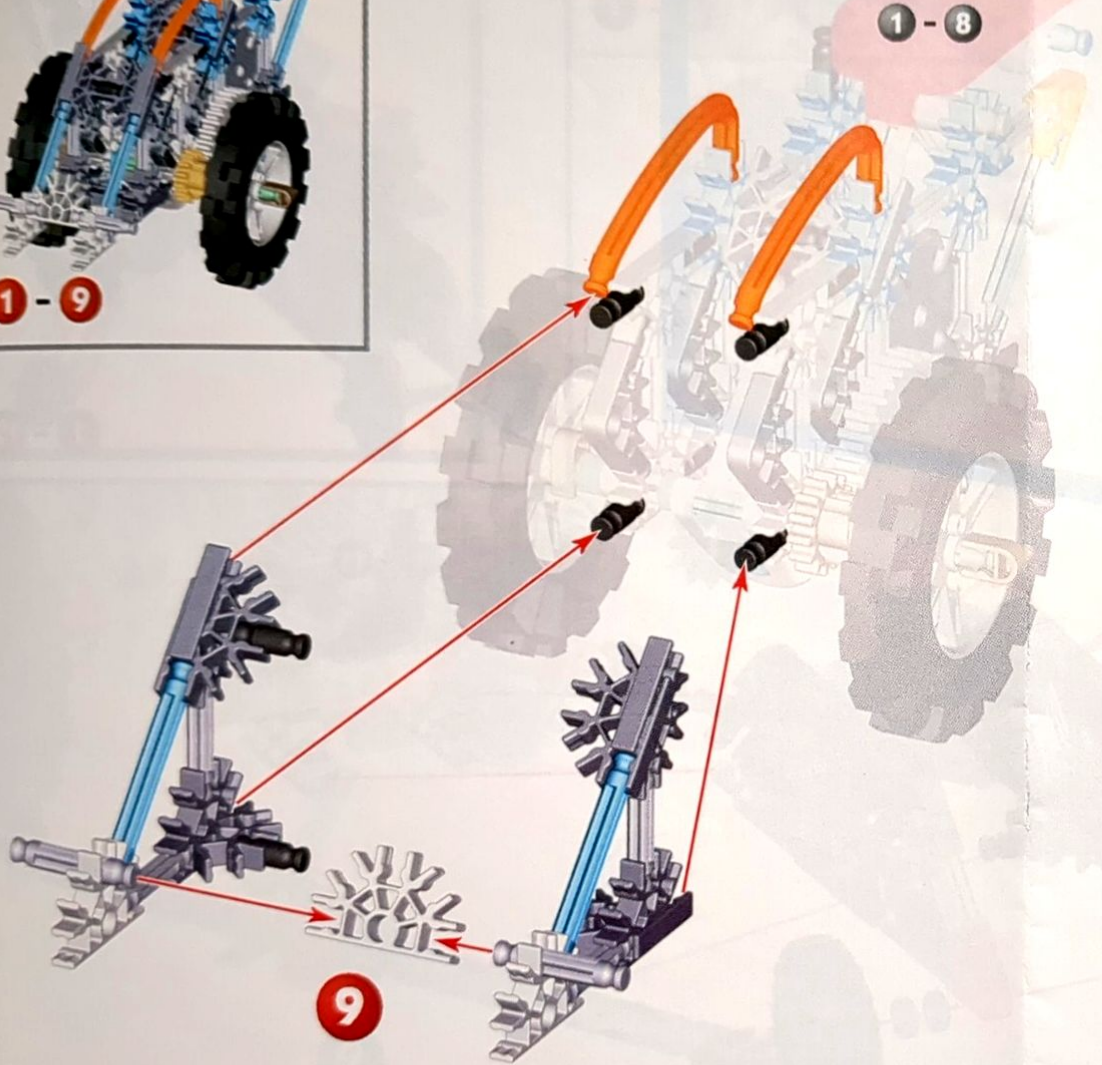

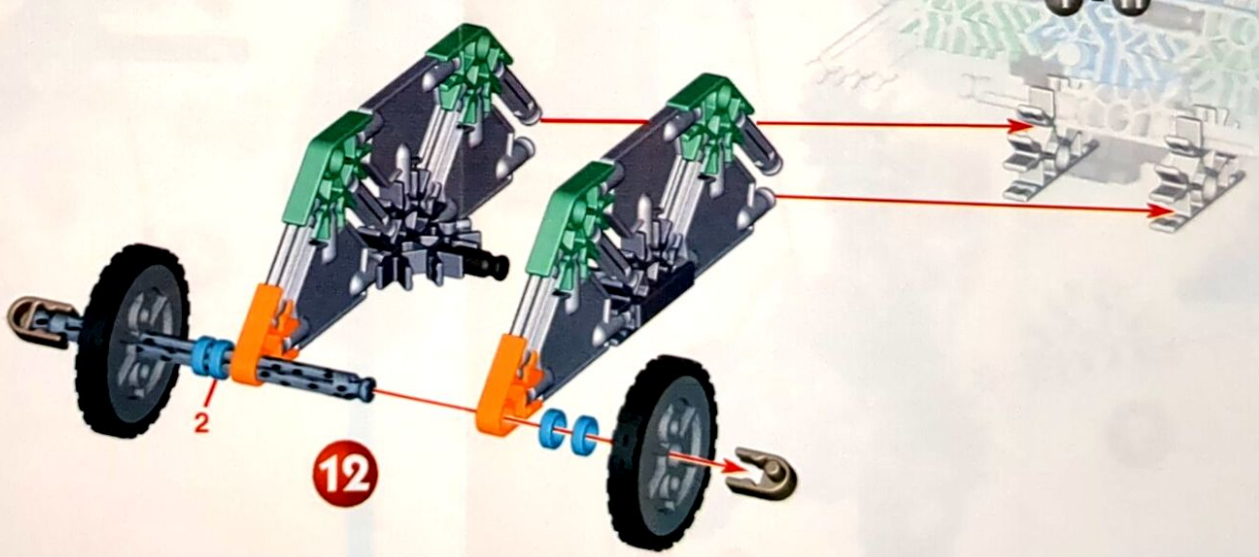
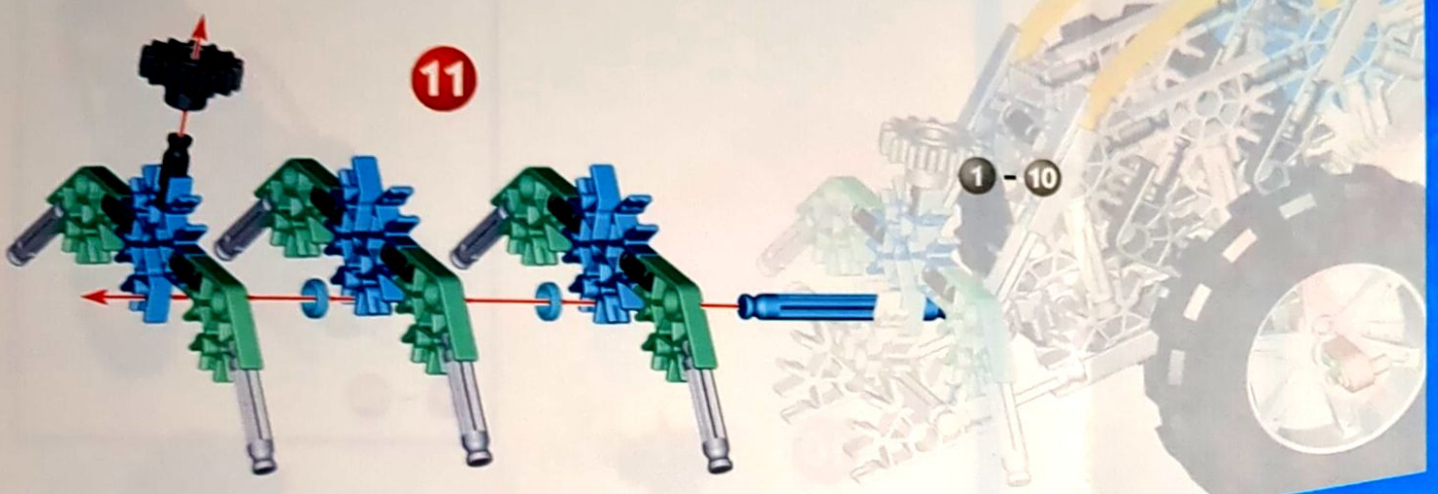

# VILD VHEELIE

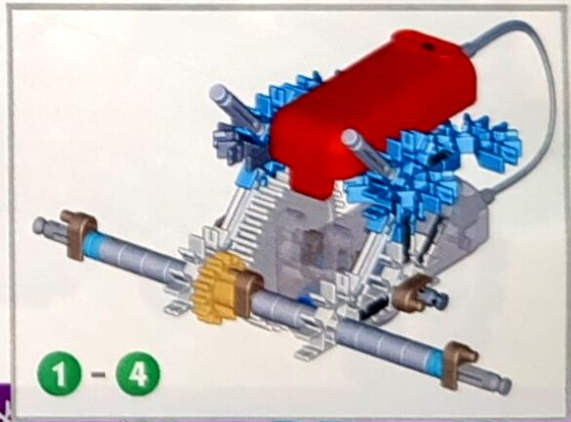
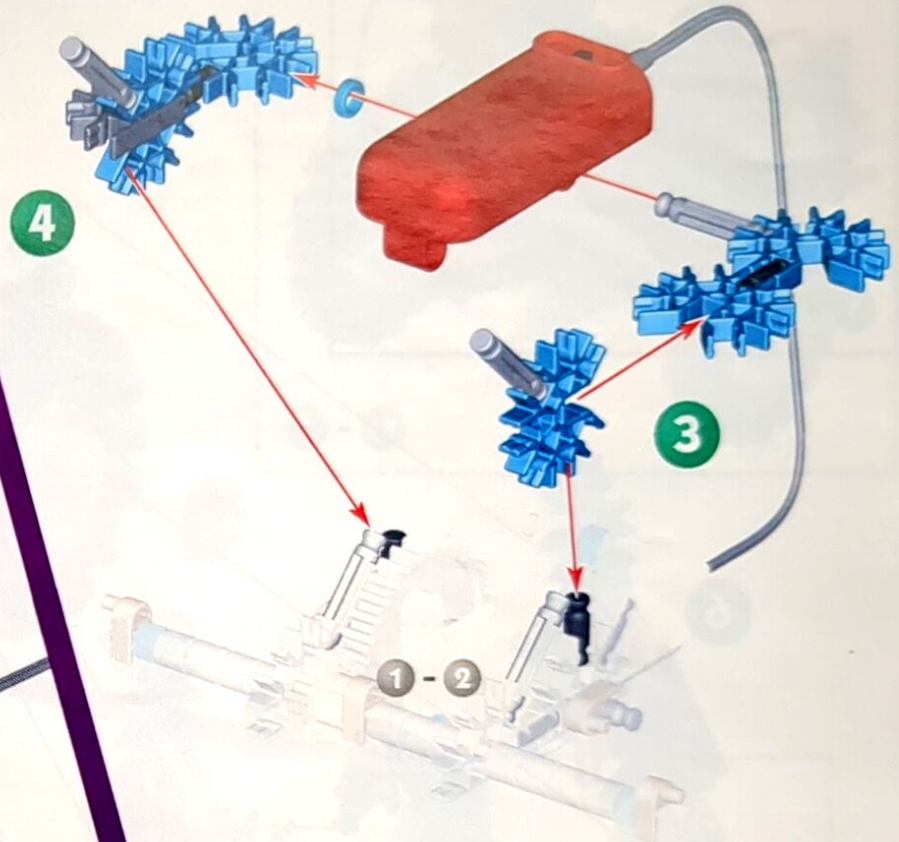
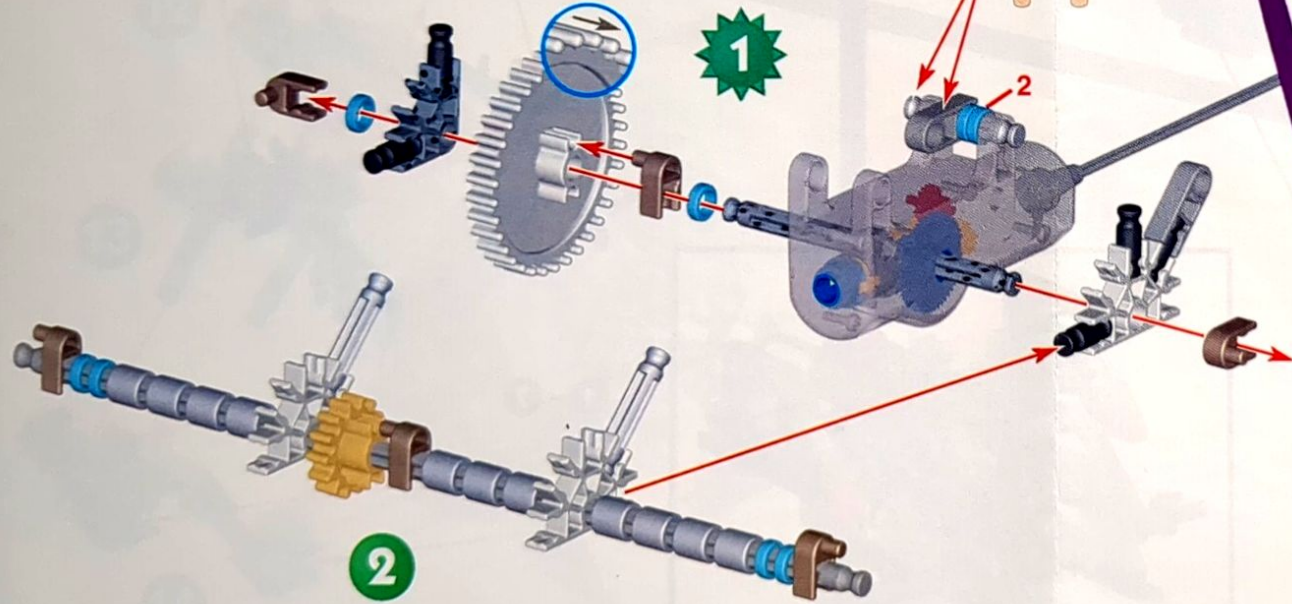
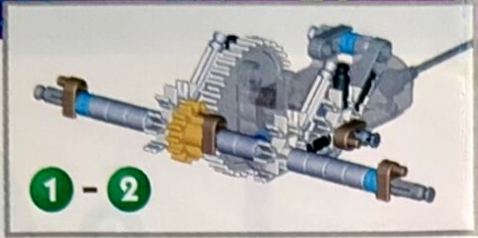

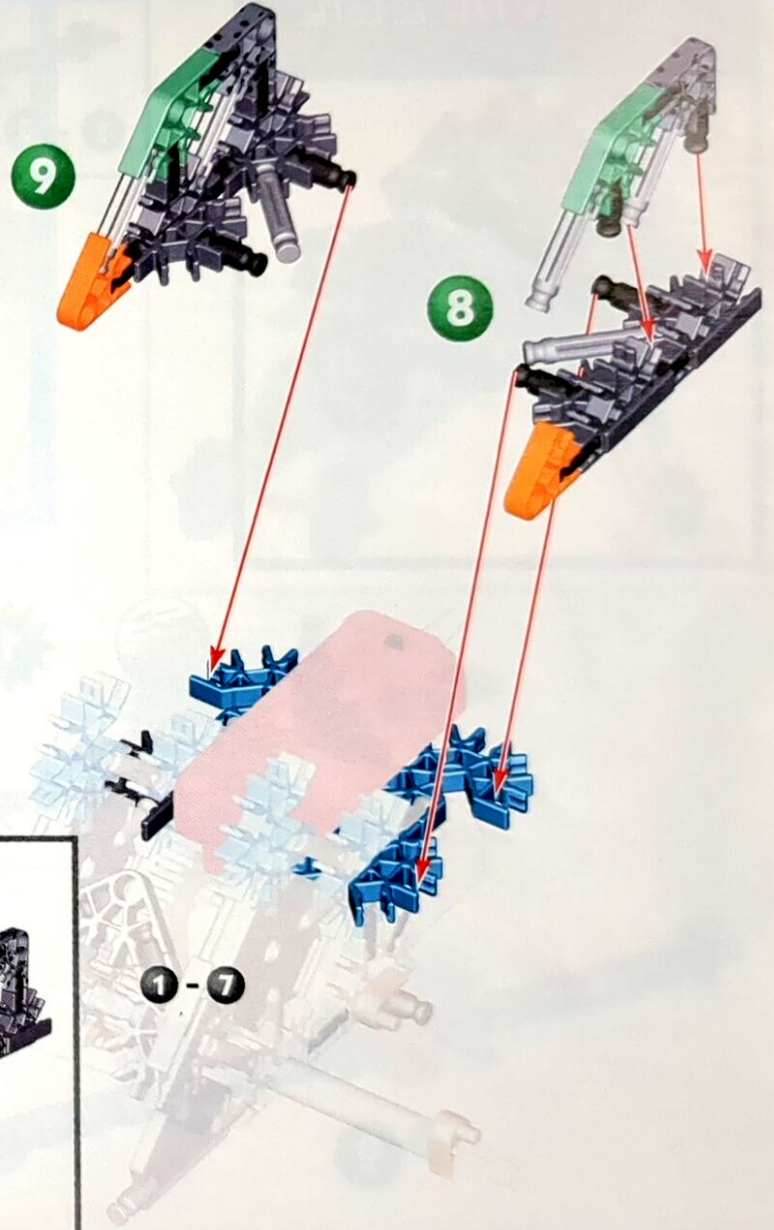
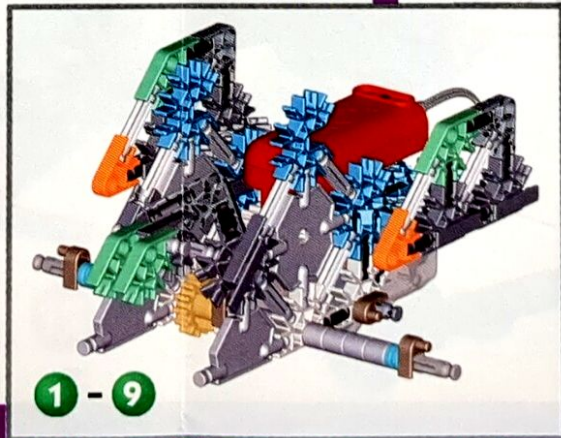
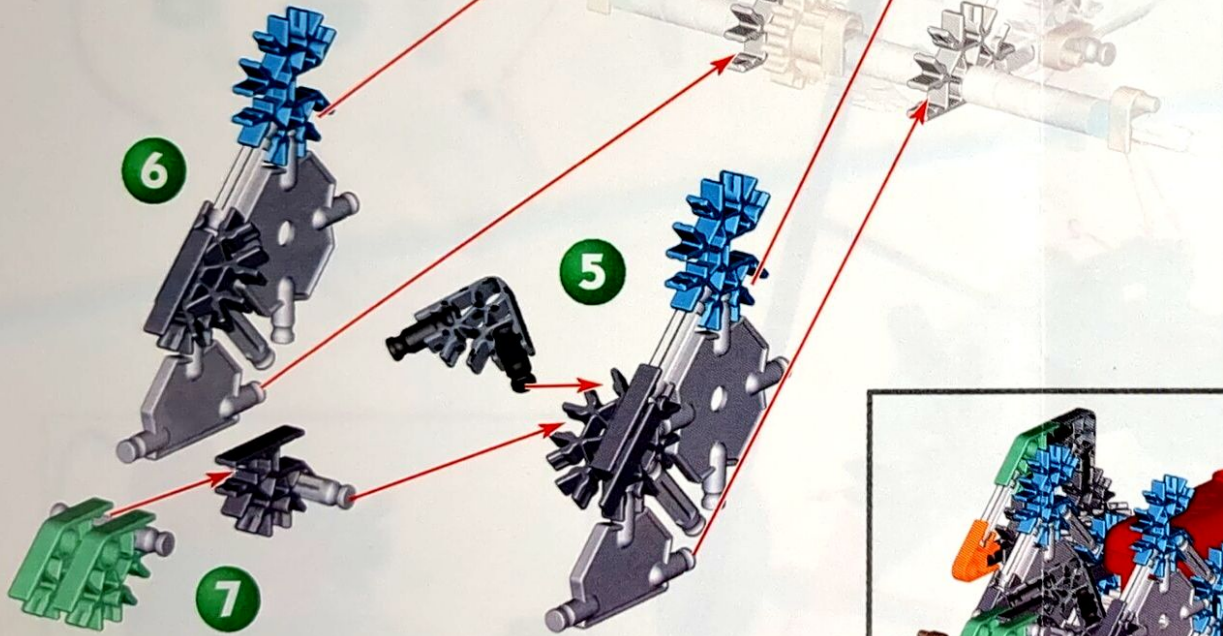
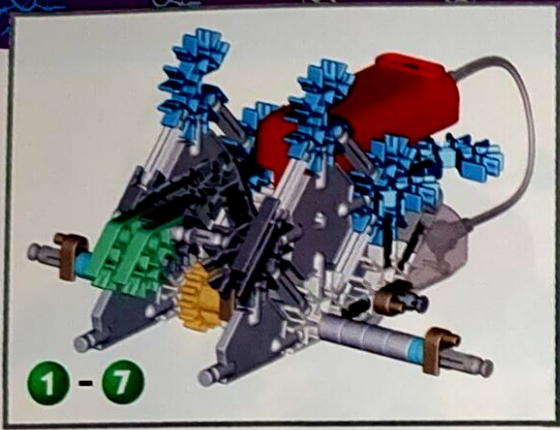

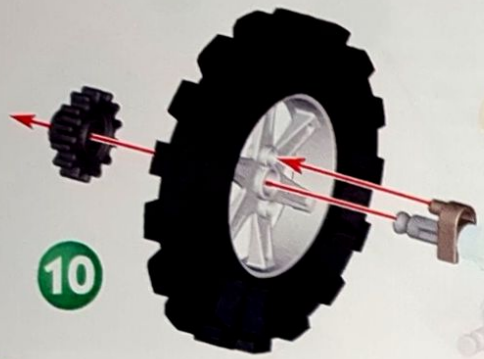

10

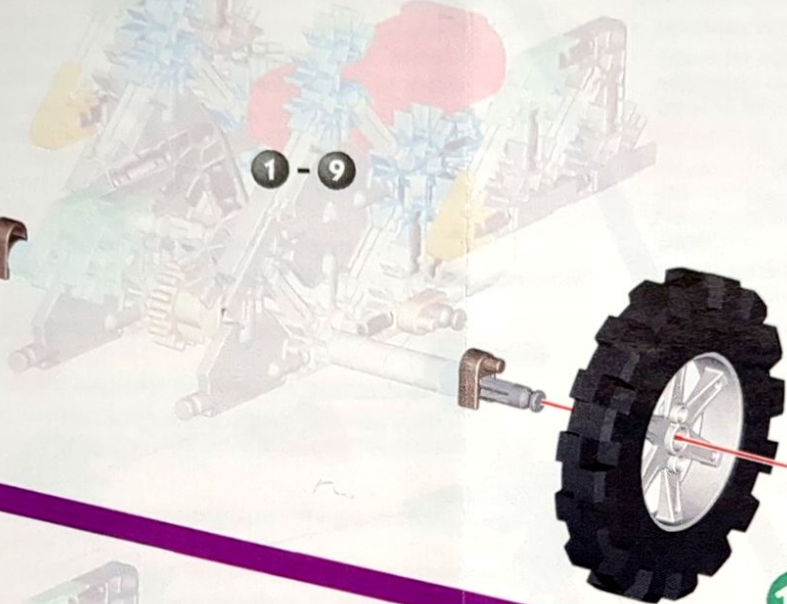

11

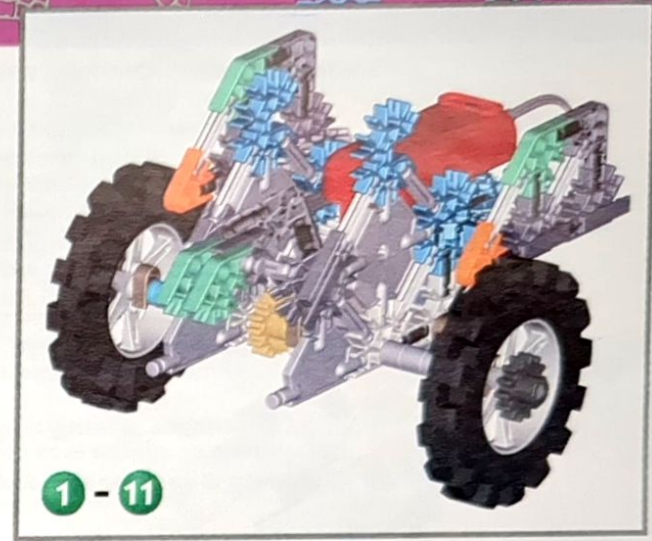

1 - 11

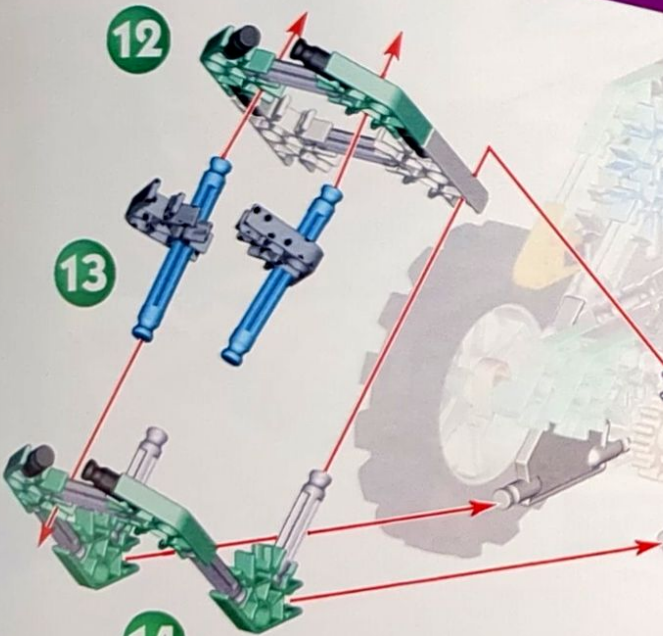

12

13

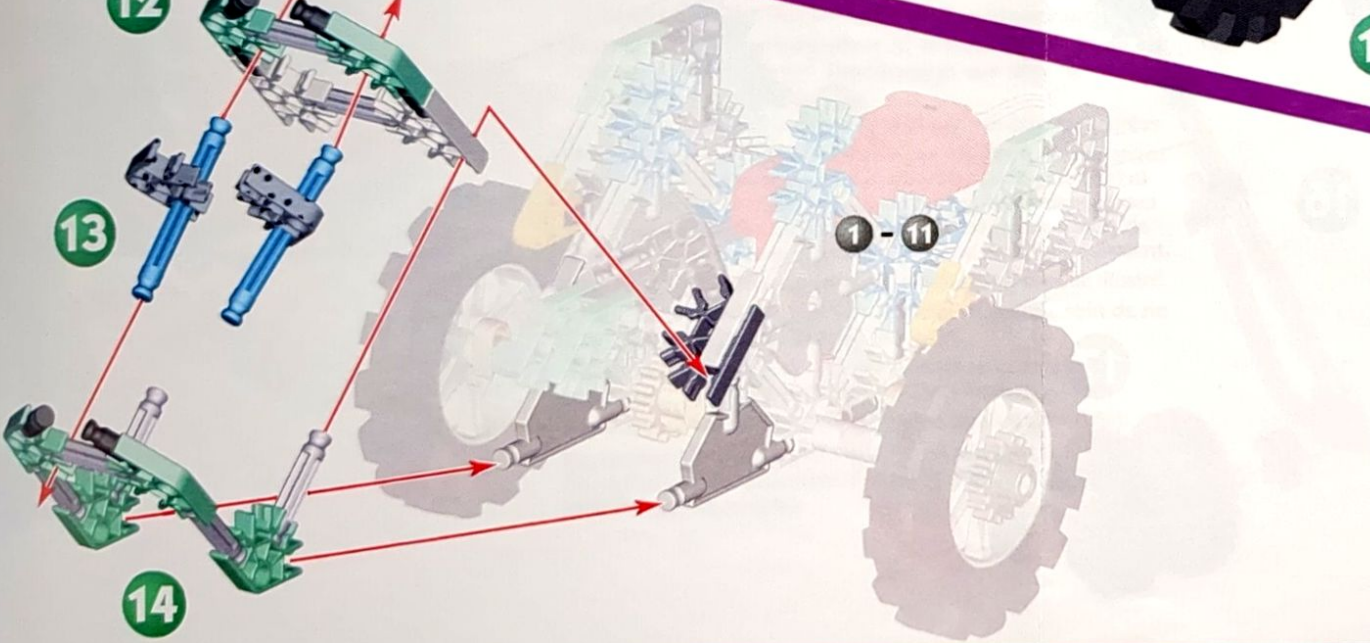

14

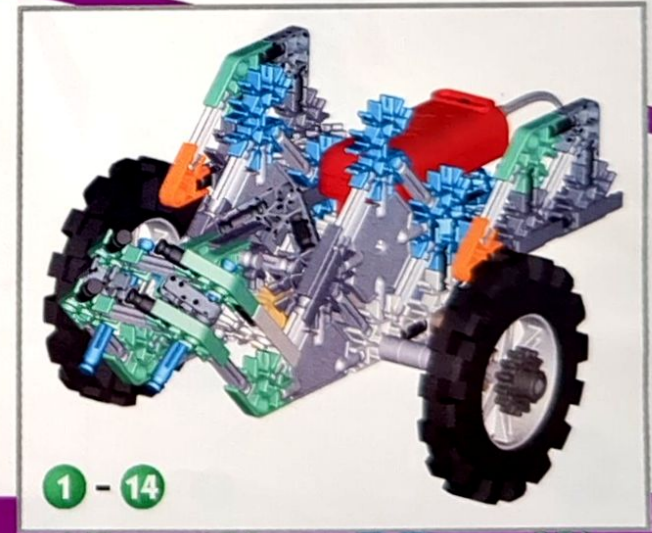

1 - 14

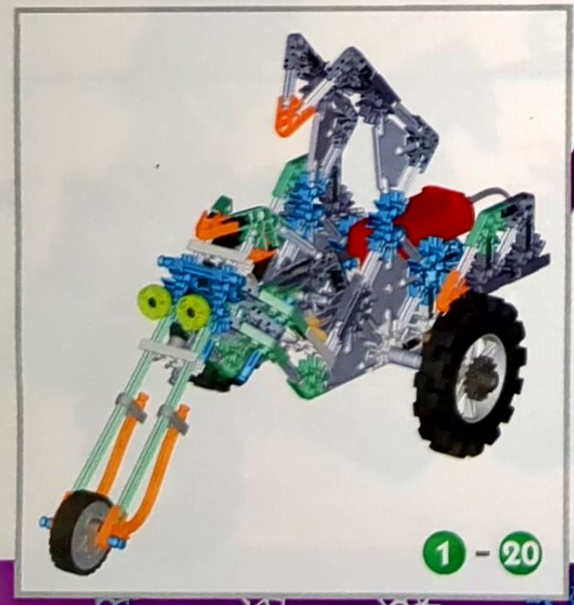
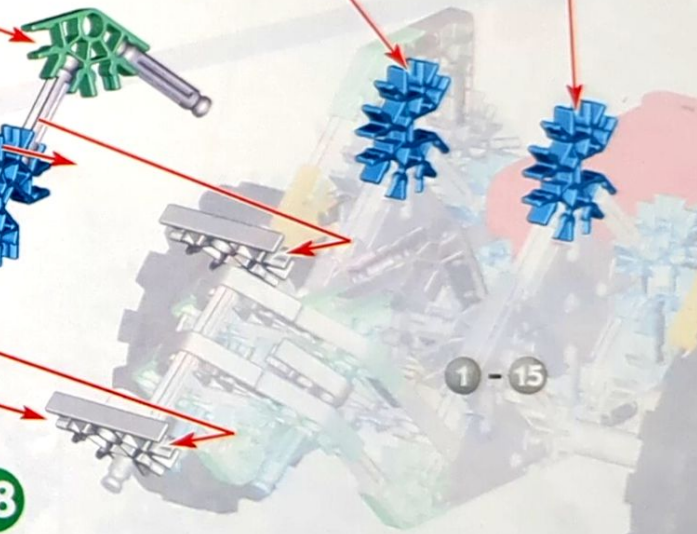
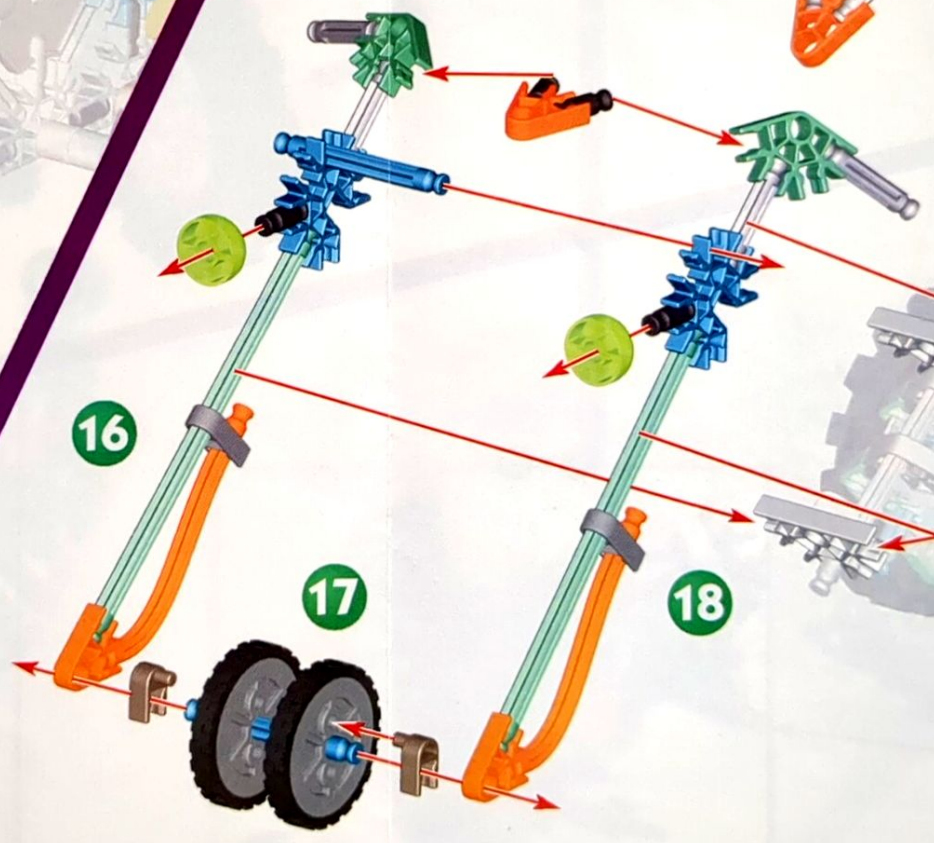
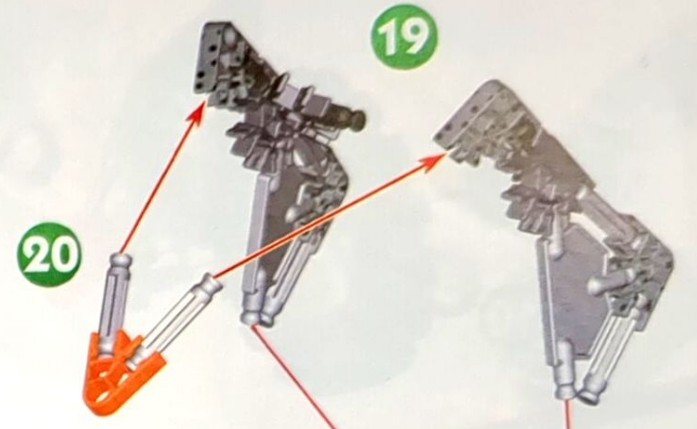
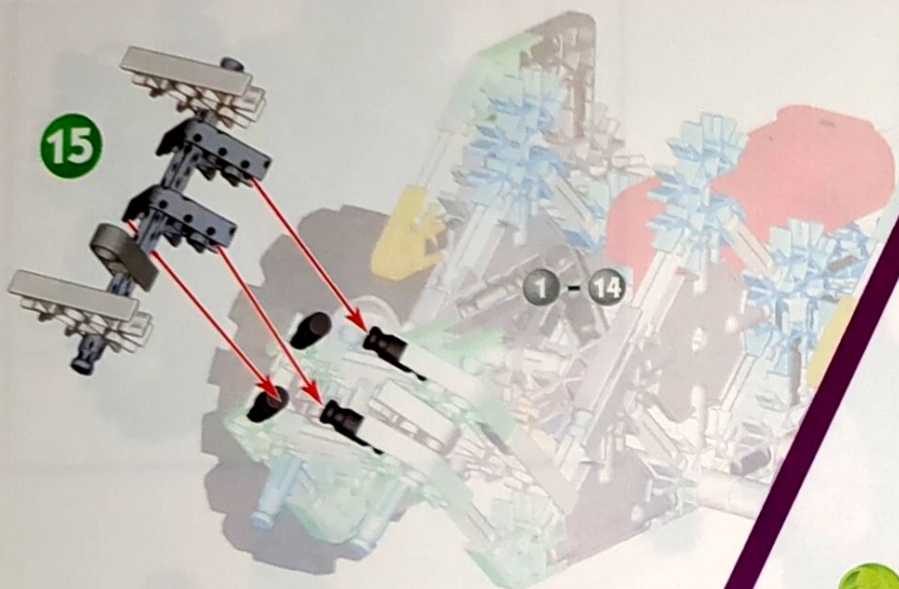



**Keep this important information for future reference.**

- Do not connect model to more than one PowerPack™.
- Remove rechargeable batteries from model before charging; they must be charged only under adult supervision.
- Non-rechargeable batteries must not be recharged.
- Do not mix different types of batteries; do not mix alkaline, standard (carbon-zinc), or rechargeable (nickel-cadmium) batteries. Do not mix new and used batteries. Only batteries of the same or equivalent type recommended should be used.
- Insert batteries with correct polarity (+/-) as shown.
- Remove exhausted batteries from model; do not short-circuit supply terminals.
- Keep PowerPack free of dust; do not immerse or use in water.
- Alkaline batteries AA (LR6) are recommended.
- Do not put small green Rods in any openings of the PowerPack; they will damage the Motor, and cannot be removed.

**Conservez ces renseignements pour utilisation ultérieure.**

- Ne branchez pas la maquette à plus d'un PowerPack.
- Enlevez les piles rechargeables de la maquette avant de les charger. Elles ne doivent être chargées que sous la supervision d'un adulte.
- Les piles non rechargeables ne doivent pas être rechargées.
- Ne mélangez pas les différents types de piles. Ne mélangez pas les piles alcalines, les piles standard (zinc-carbone) ni les piles rechargeables (nickel-cadmium). Ne mélangez pas des piles neuves et des piles usées. Il est recommandé de n'utiliser que des piles du même type ou de type équivalent.
- Insérez les piles en respectant la polarité (+/-), comme illustré.
- Enlevez les piles usées de la maquette et prenez soin de ne pas court-circuiter les bornes des piles.
- Maintenez le PowerPack propre et sans poussière. Ne l'immergez pas et ne l'utilisez pas dans l'eau.
- Il est recommandé d'utiliser des piles alcalines AA (LR6).
- Ne mettez pas les petites tiges vertes dans les trous du PowerPack, elles endommageraient le moteur et il n'est pas possible de les enlever.

**Guarde esta importante información para consultarla más adelante.**

- No conecte el modelo a más de un PowerPack.
- Saque las pilas recargables del modelo antes de cargarlas; solamente deben cambiarse con la supervisión de una persona adulta.
- Las pilas no recargables no deben recargarse.
- No mezcle diferentes tipos de pilas; no mezcle pilas alcalinas, estándar (carbono-zinc) o recargables (níquel-cadmio). No mezcle las pilas nuevas y las usadas. Solamente deben usarse pilas del mismo tipo recomendado o equivalente.
- Inserte las pilas con los polos (+/-) en posición correcta, tal como se indica.
- Saque del modelo las pilas gastadas; asegúrese de no provocar un cortocircuito en el terminal de alimentación.
- Mantenga el PowerPack libre de polvo; no lo sumerja ni lo use en agua.
- Se recomiendan baterías alcalinas AA (LR6).
- No meta las varillas verdes pequeñas en los orificios del PowerPack, ya que dañarían el motor y no se podrían sacar.

# K'NEX®

**COOL MACHINES**

## POPPIN' WHEELIES

HIGH KICKIN' ROADSTERS!

Questions? Call us  
at 1-800-KID-KNEX  
(USA/Canada only)  
[www.knex.com](http://www.knex.com)

©2000 K'NEX Industries, Inc.  
P.O. Box 700  
Hatfield, PA 19440-0700



Assembled in U.S.A.  
using U.S. components;  
motor made in China.

Assemblé aux États-Unis  
avec des pièces  
fabriquées aux États-Unis.  
Moteur fabriqué en Chine.

94283-V1-4/00

ALSO BUILDS  
**WILD WHEELIE**

ALSO BUILDS  
**WICKED WHEELIE**

Colors and product may vary.  
Set contains 1 PowerPack™ motor.  
2 AA batteries required; batteries not included.

Le produit et les couleurs peuvent varier.  
L'ensemble comprend 1 moteur PowerPack™.  
2 piles AA sont requises; piles non comprises.

El producto y los colores pueden variar.  
El juego contiene 1 motor PowerPack™.  
Funciona con 2 pilas AA (no incluidas)

K'NEX is a registered trademark of K'NEX est une  
marque déposée de K'NEX Industries, Inc.

Manufactured under U.S. Patents/Fabriqués sous brevets  
américains 5,061,219; 5,137,484; 5,199,919; 5,238,438;  
5,346,420; 5,350,331; 5,368,514; 5,421,762; 5,423,707;  
5,427,559; 5,518,435; D383,509; D388,475; D389,203;  
D391,843; D391,921; D392,555. Other U.S. and foreign  
patents pending./Autres brevets américains et étrangers  
en instance.

Conforms to the Requirements of ASTM Standard Consumer  
Safety Specification on Toy Safety, F963-96a./Conforme  
aux spécifications de sécurité du consommateur sur la  
sécurité des jouets de la norme ASTM F963-96a.