

K'NEX®

OVERDRIVE

MONSTER TRUCK



Flip-Up Body!



Car Crushin' Tires!

WARNING:
CHOKING HAZARD - Small Parts.
Not for children under 3 years.

AVERTISSEMENT:
DANGER D'ÉTOUFFEMENT - Pièces de petite taille.
Ne pas donner aux enfants de moins de 3 ans.

COLOR CODED BUILDING SYSTEM

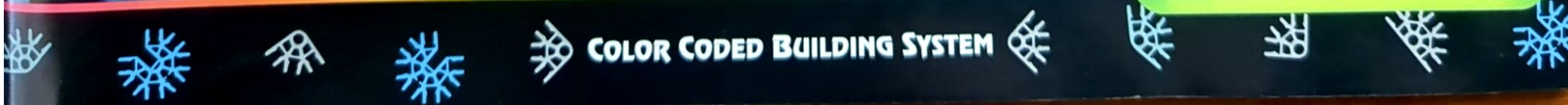

OVERDRIVE

MONSTER TRUCK

CONTENTS

Welcome	2
Building with K'NEX	3
Parts Checklist	4
Other Cool Machines	4
Building Instructions:	
OVERDRIVE	5
POWER SURGE	30
HIJACKER	51
Cut-Out Flags	74
French Language	75

Welcome to the big bad world of Monster Truck racing! Monster Trucks have giant tires, huge engines, and racing graphics that are full of car-crushing attitude! During a race, two Monster Trucks race side-by-side over an obstacle course of jumps and old rusty cars. The first one to cross the finish line is the winner!

This OVERDRIVE set lets you build the meanest, most authentic Monster Trucks around. Modeled after a real Monster Truck, OVERDRIVE features gigantic tires and car-crushing suspension that really works! The body of the truck can even be raised to reveal the driver's seat and underbody of the truck! Once built, attach the customized racin' graphics and big engine piece for an ultra cool look!

Flip-Up Body!



Car Crushin' Tires!



1

Building with K'NEX

Hi! I'm your K'NEX mechanic. When you see me in the instructions, you'll want to pay close attention to the details being pointed out.

Movin' On

The faded colors tell you this section is already built. You'll want to connect the new section to the place where the arrows are pointing. This piece will be in full color.

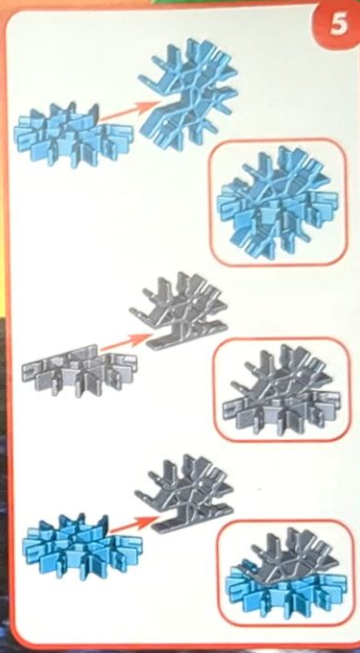

5

Connectors

There are blue and silver Connectors with special long slots. They slide together as you see in the pictures. Push the parts together until you hear a "click".

Ready, Set, Build

To begin your model, find the  and follow the numbers. Each piece has its own shape and color. Just look at the picture, find the pieces in your set that match what you see, and snap them together. Try to hold your model in the same direction as in the picture so you'll attach your pieces to the right place.

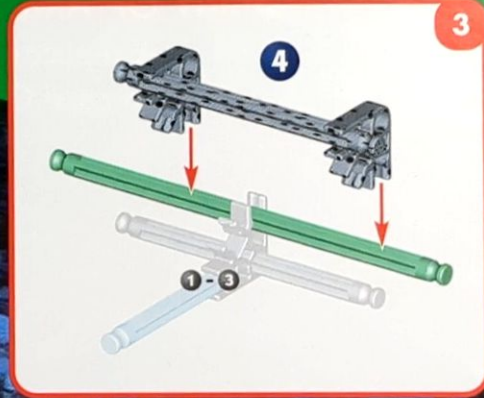

3

Spacers

There are places in your model where you need to add blue and silver Spacers. Be sure to use the right color and count them carefully.

Shocks

K'NEX Shock Absorbers come in two pieces. Push them together until you hear a "click".

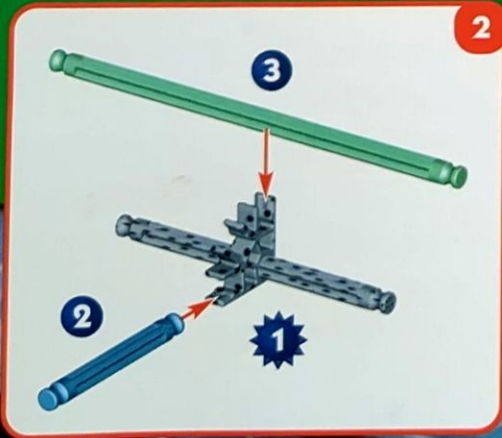

2

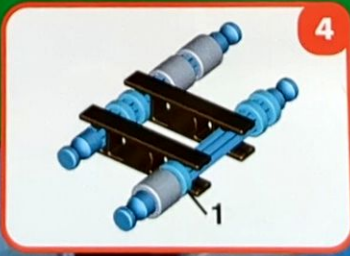

4



6

PARTS CHECKLIST

Before you start building, be sure to compare the parts in your set with the parts listed below. If anything is missing, call our Kid K'NEX hotline: 1-800-KID-KNEX (US and Canada only) from 8:30 am to 5:00 pm EST, Monday through Friday. Call us, we're here to help!

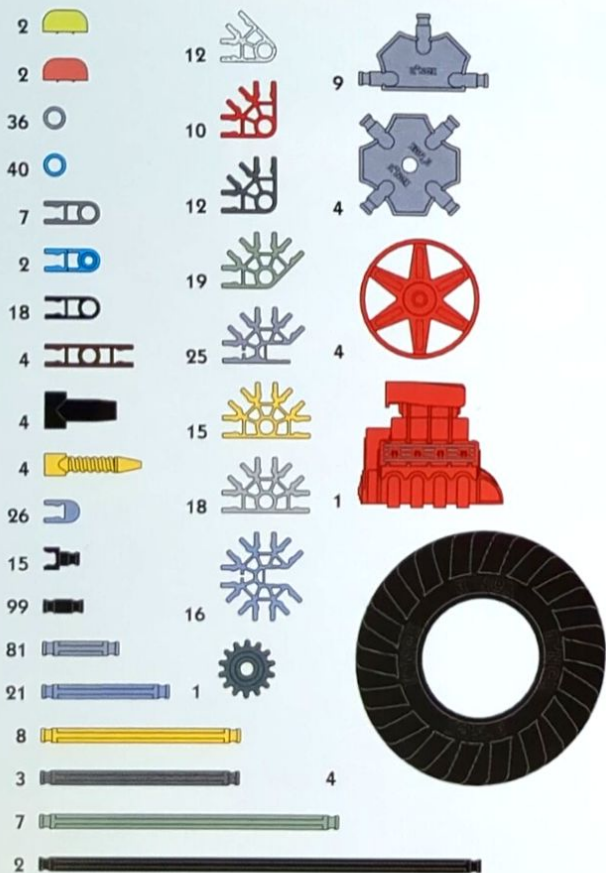

Check out these other



SPRIT OF AMERICA™

Build sleek replicas of Craig Breedlove's "Spirit of America" jet-powered cars! Comes with a Pull-out Poster included inside!



FORMULA RACERS

Build an awesome replica of a Formula one race car! With track hugging tires, rack and pinion steering, and piston poppin' engine, Formula Racers is ready to put the pedal to the metal!

OVERDRIVE

- Just as the name says...
Drive OVER the competition!

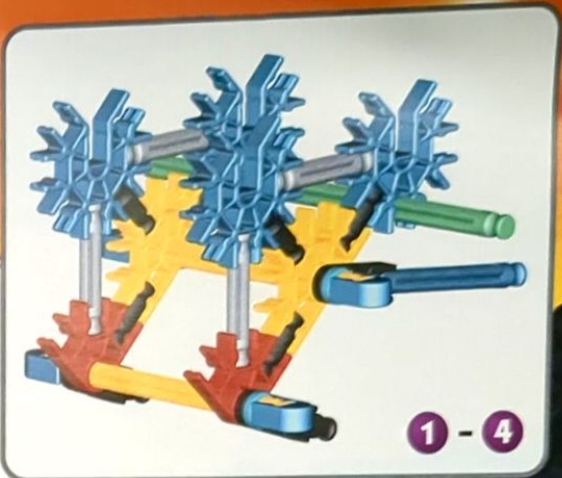
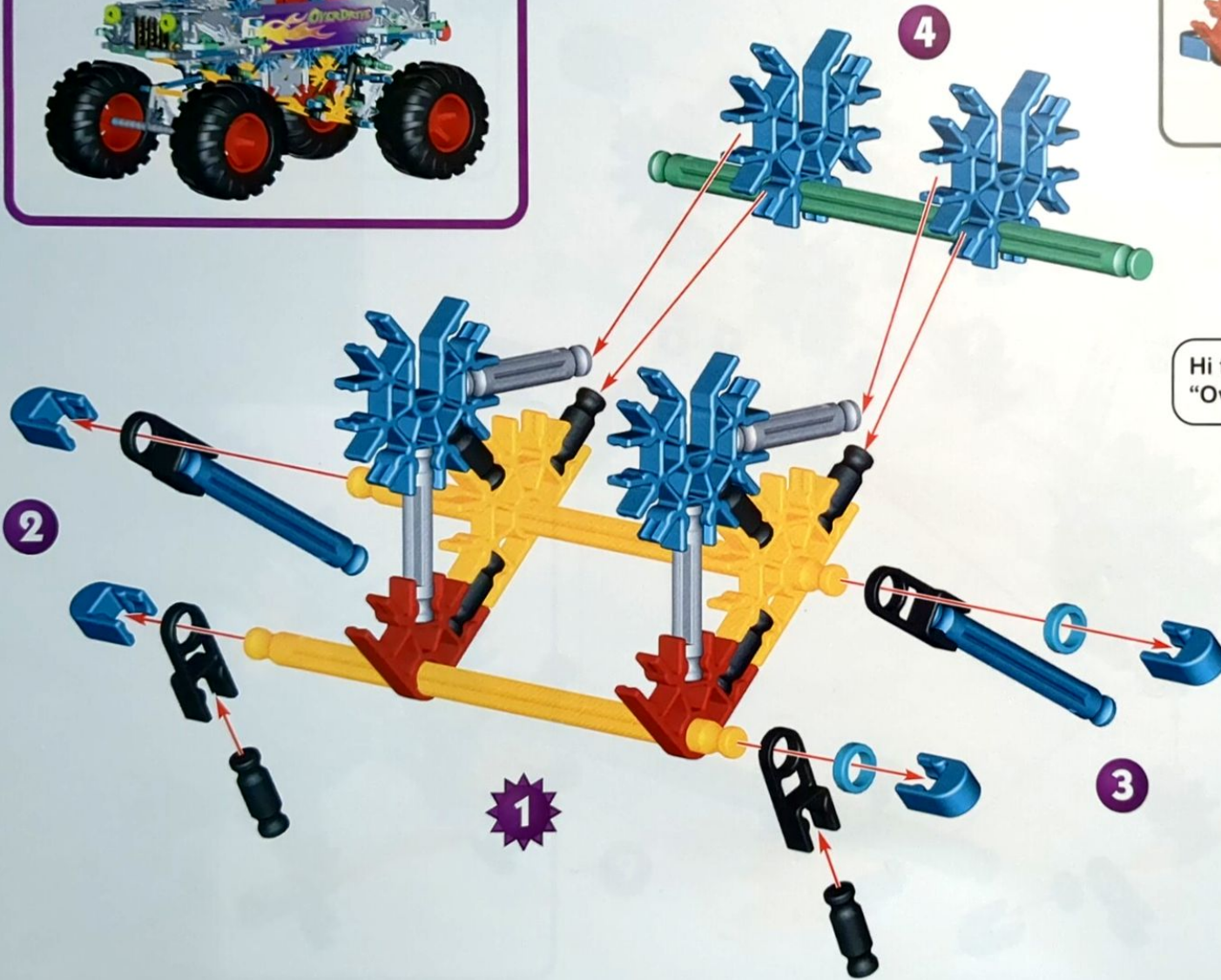

Hi there! Let's build
"Overdrive!"



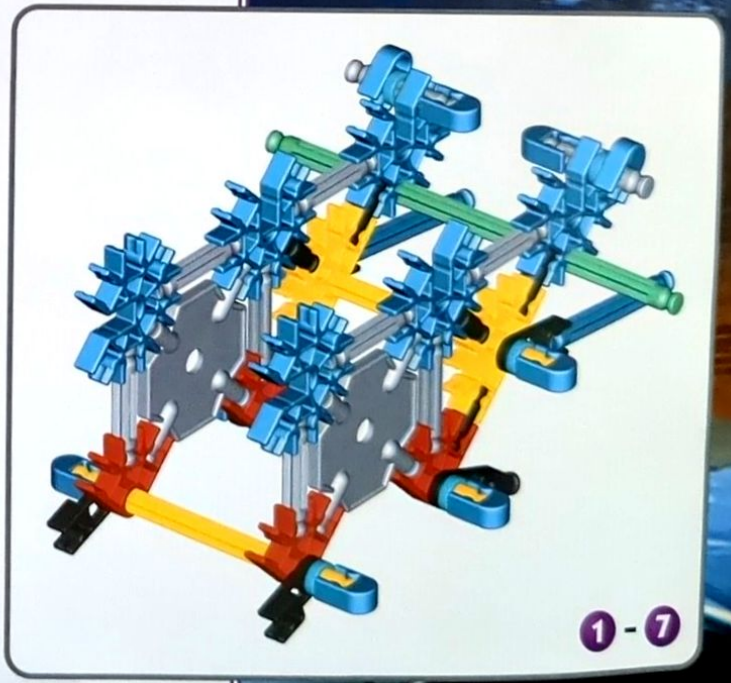
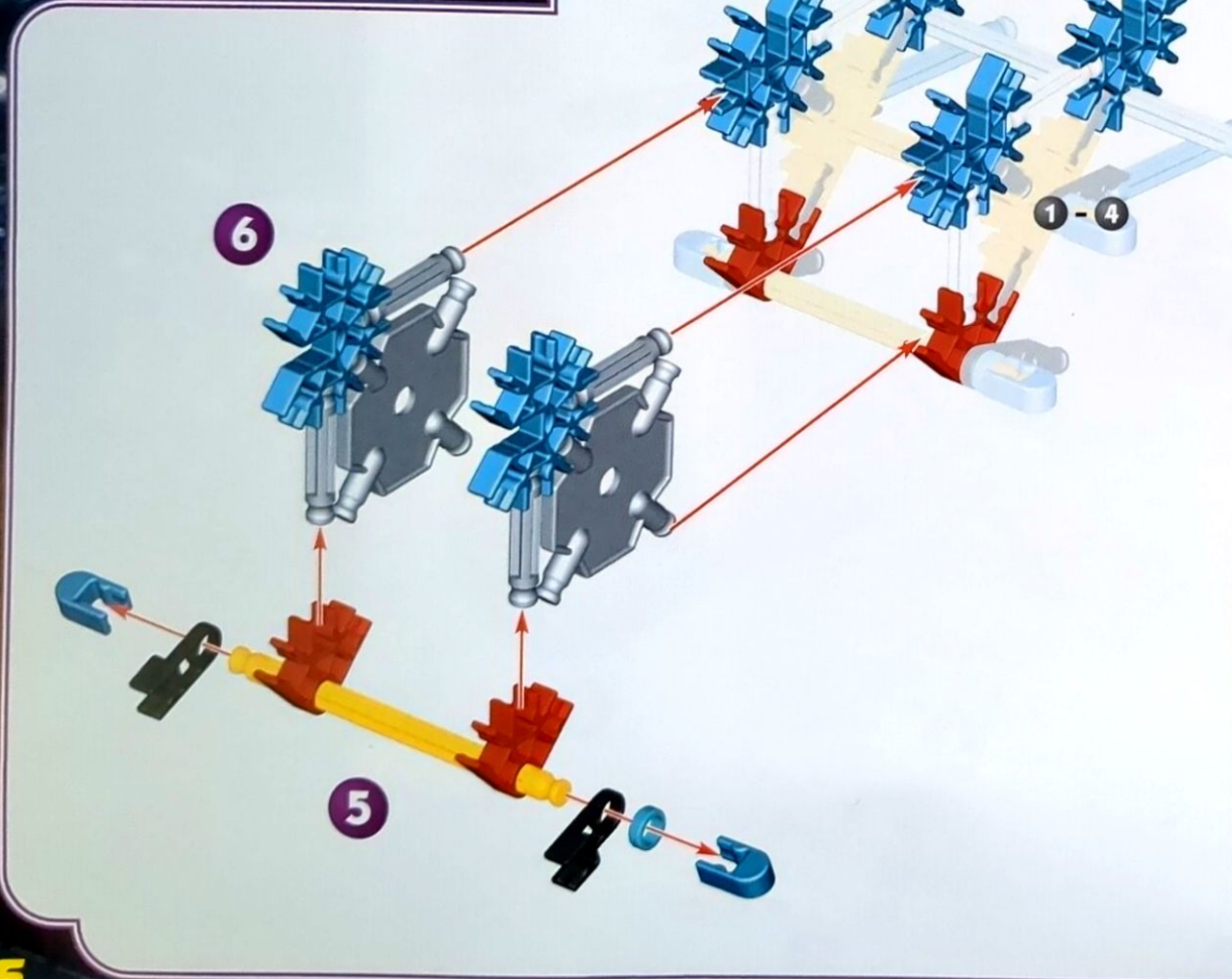
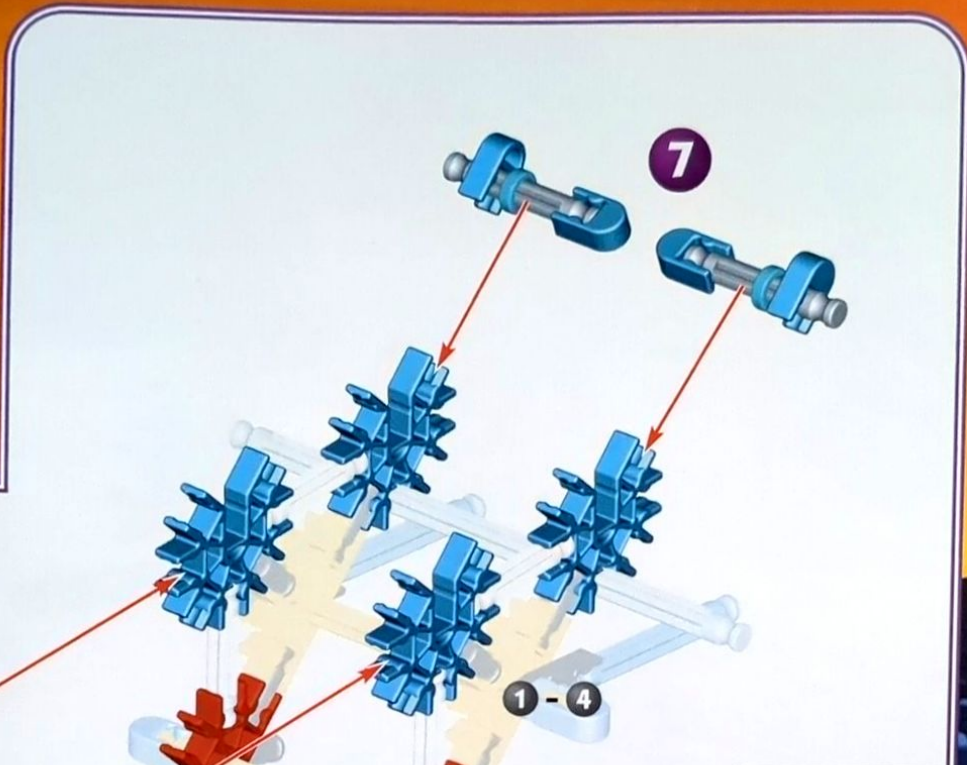

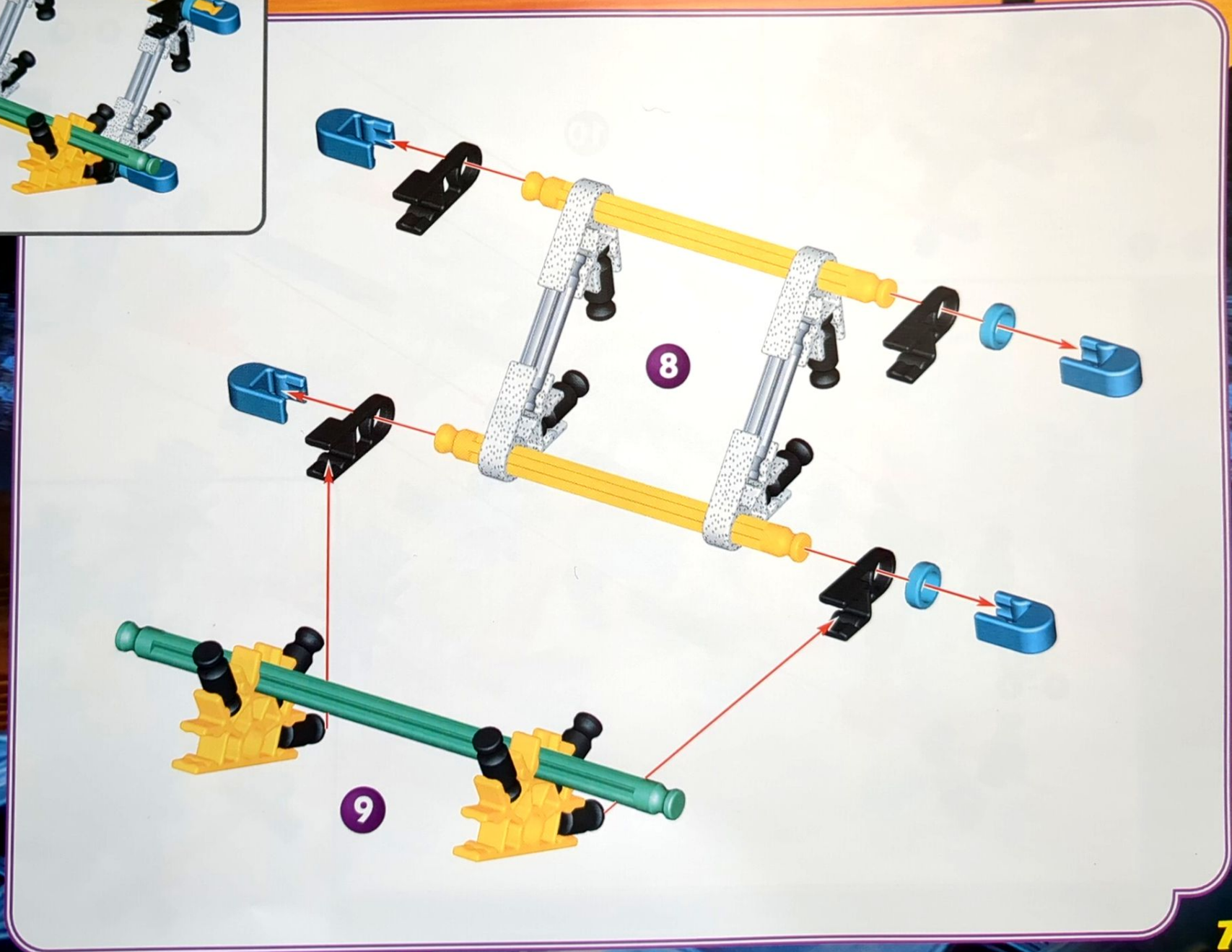
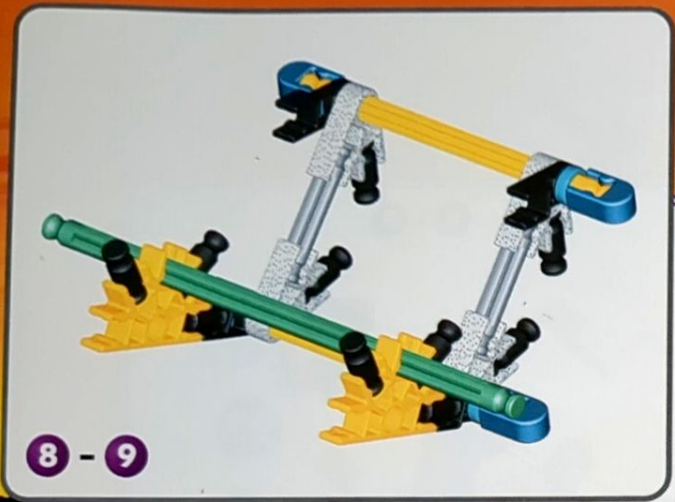

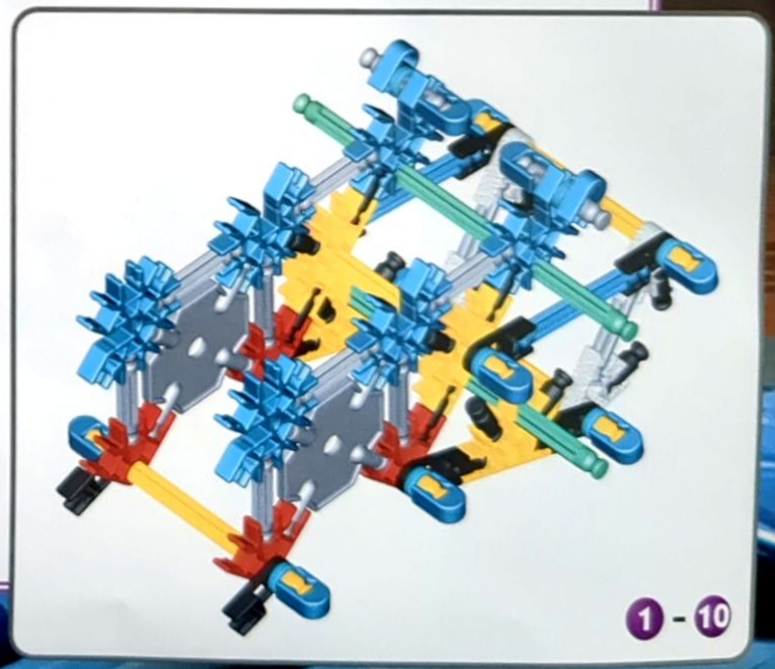
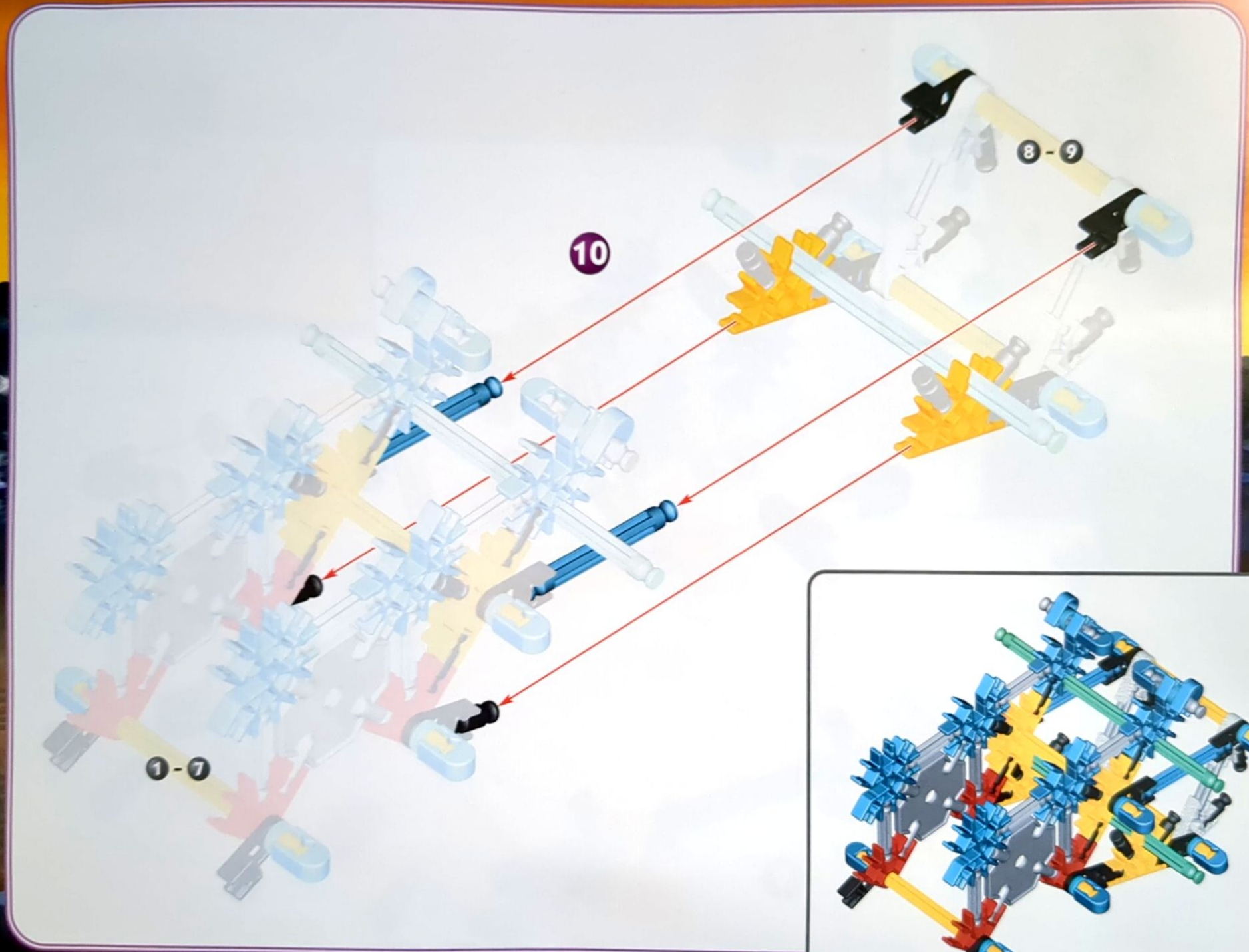

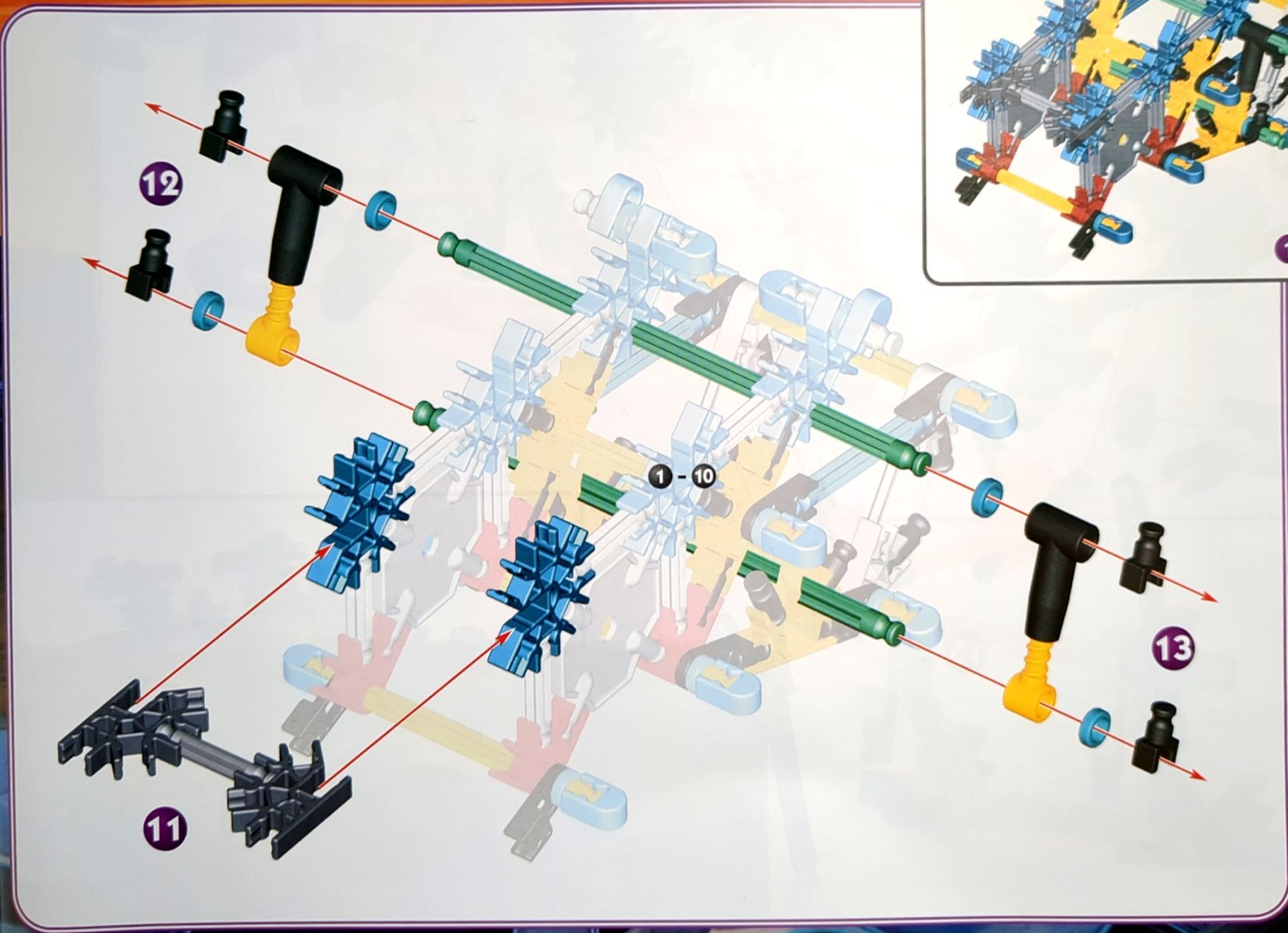
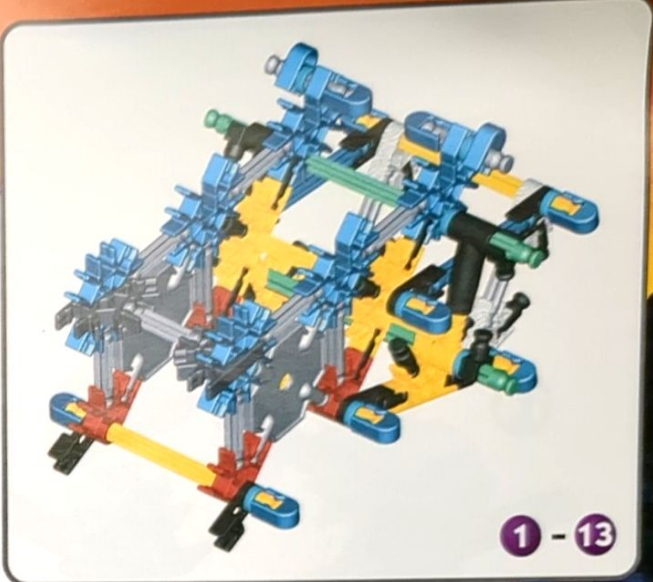

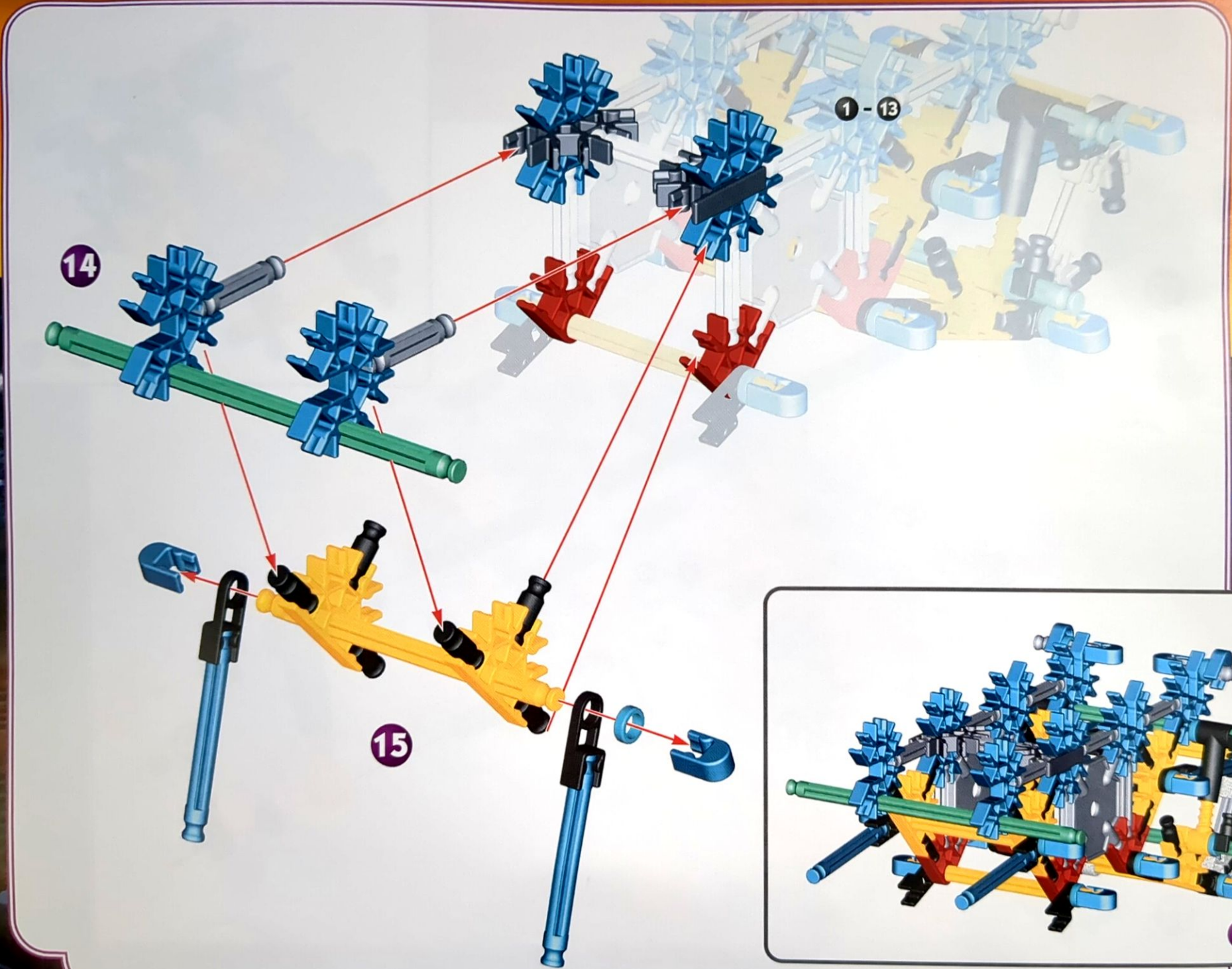

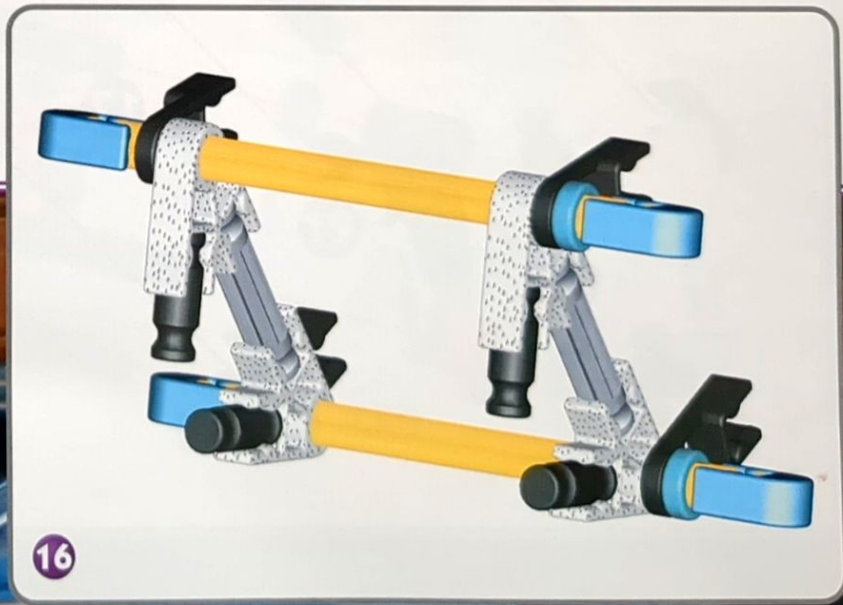
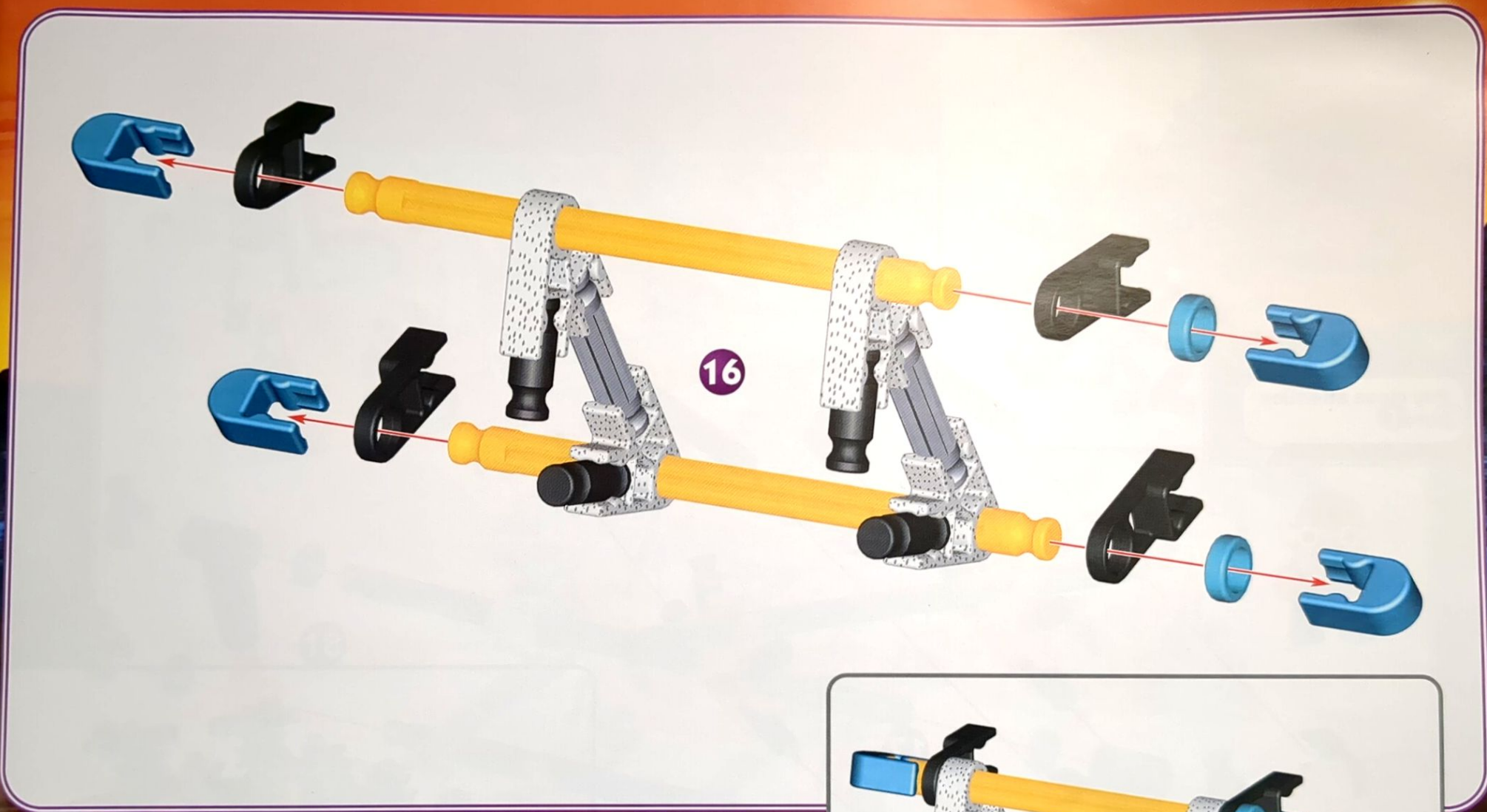

Pay close attention here!

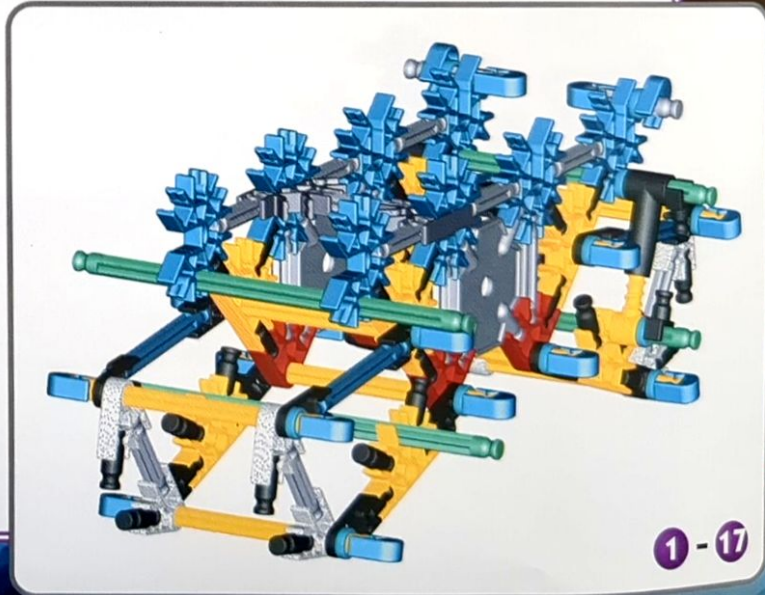
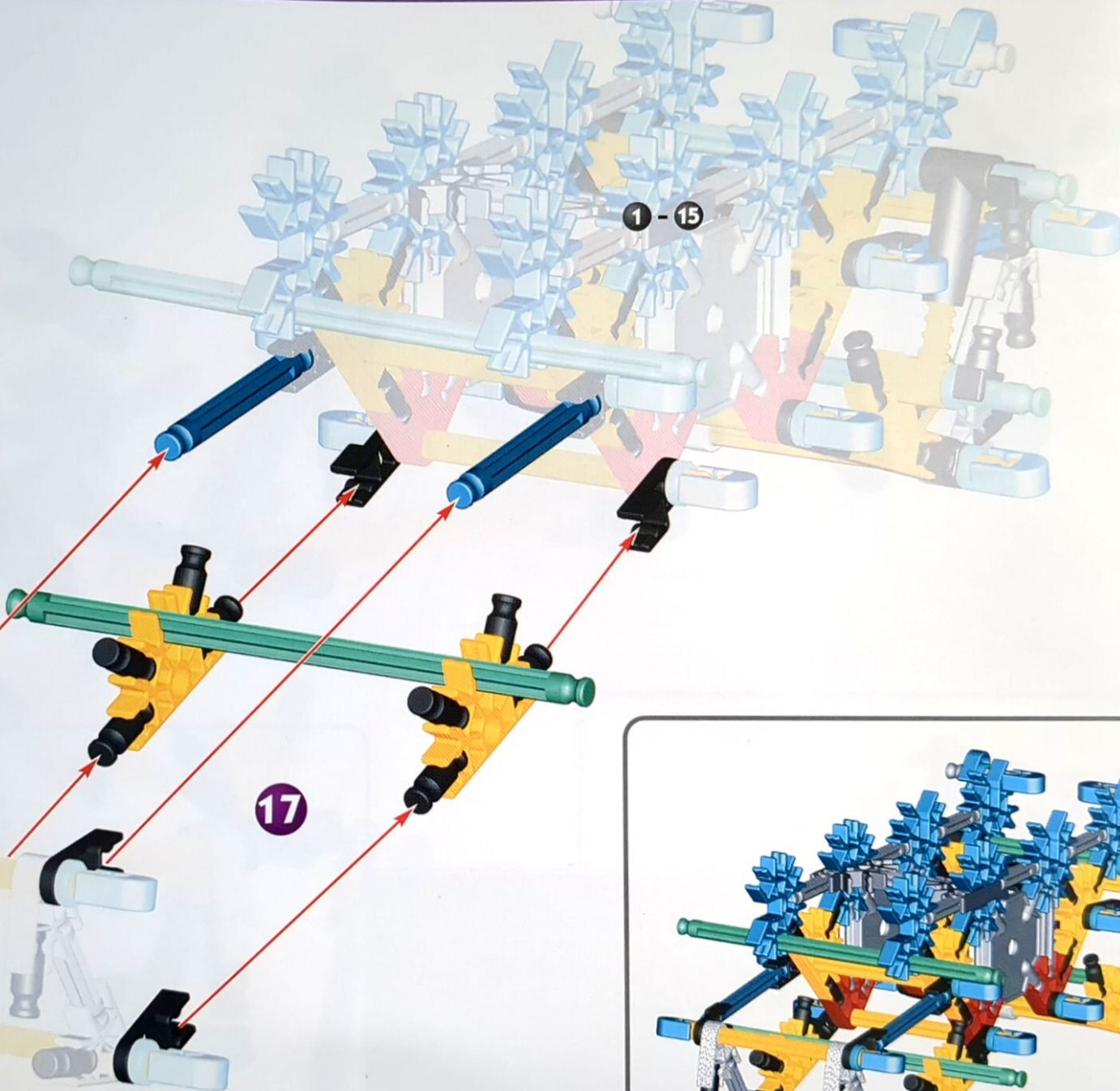

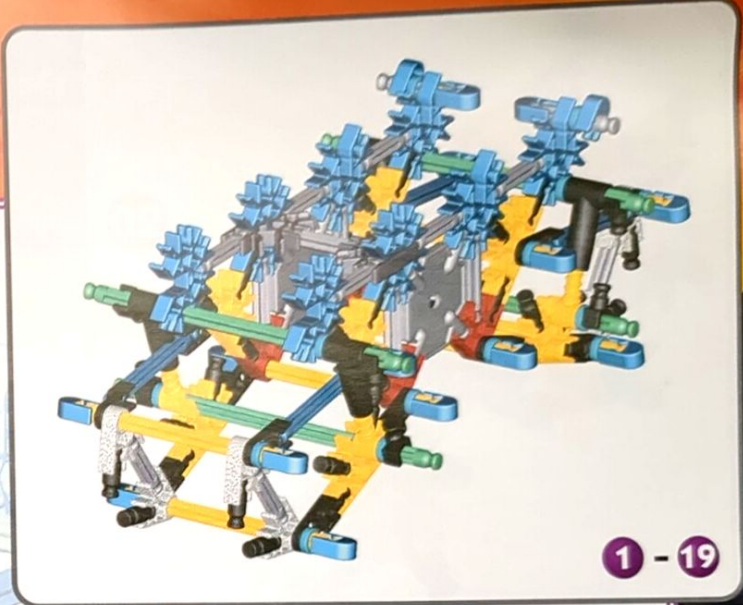

1 - 19

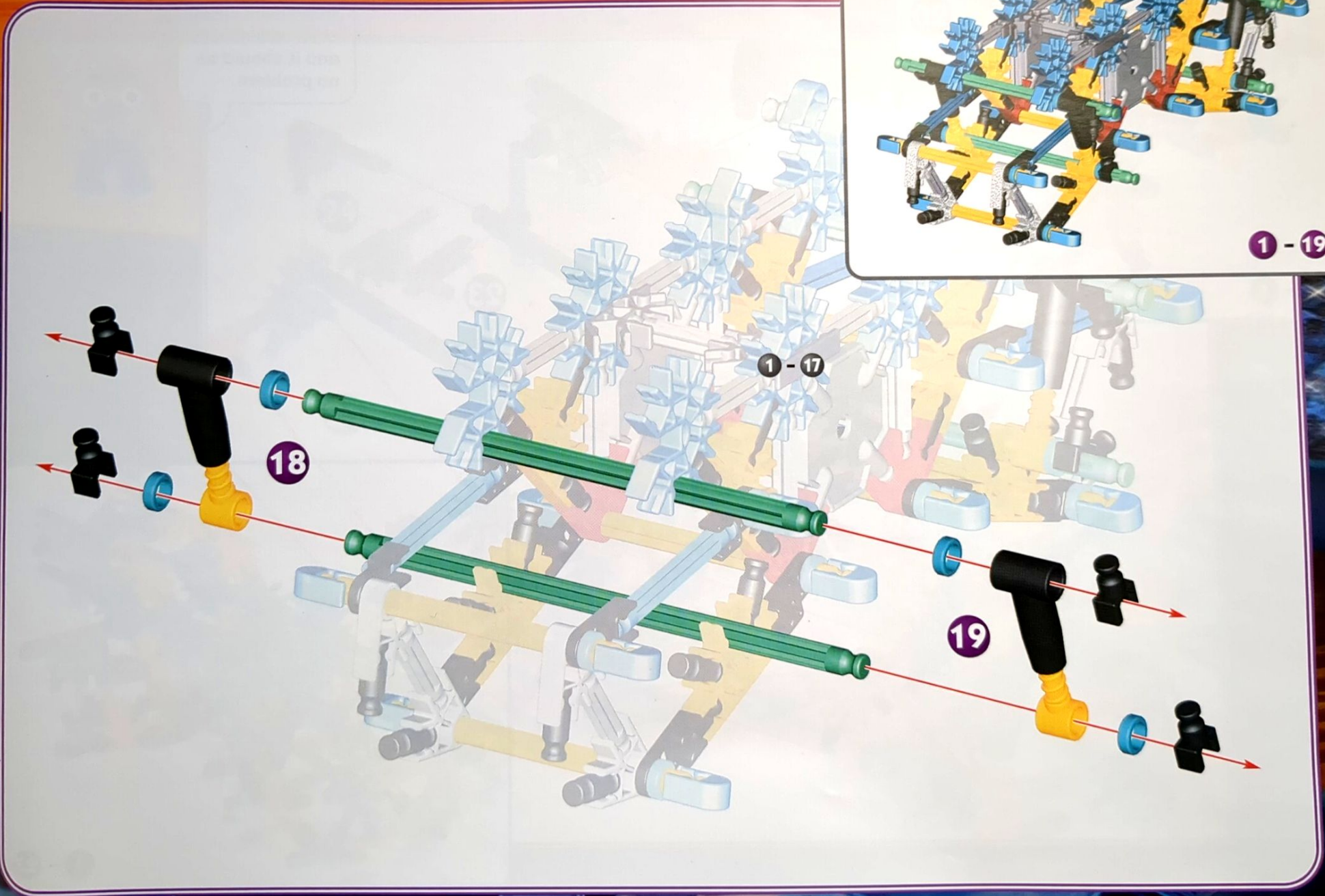

1 - 17

18

19

Here's another tricky spot... pay close attention and it should be no problem.

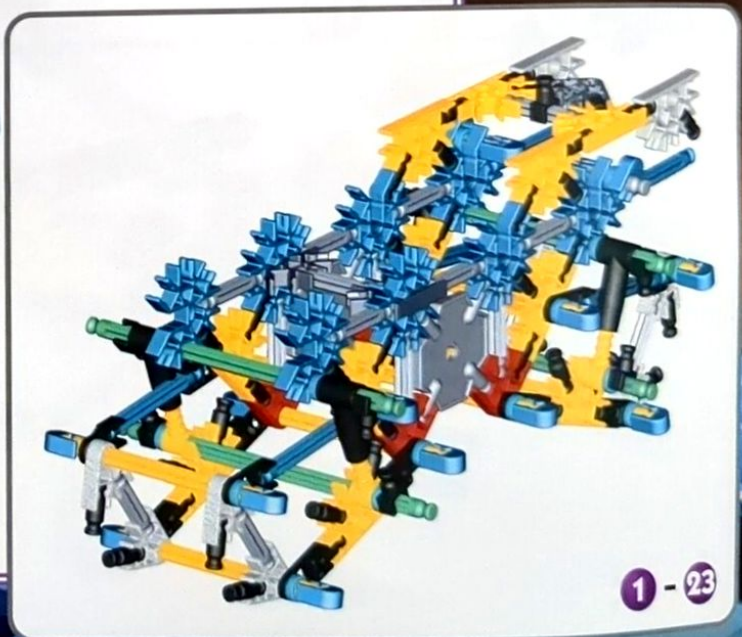
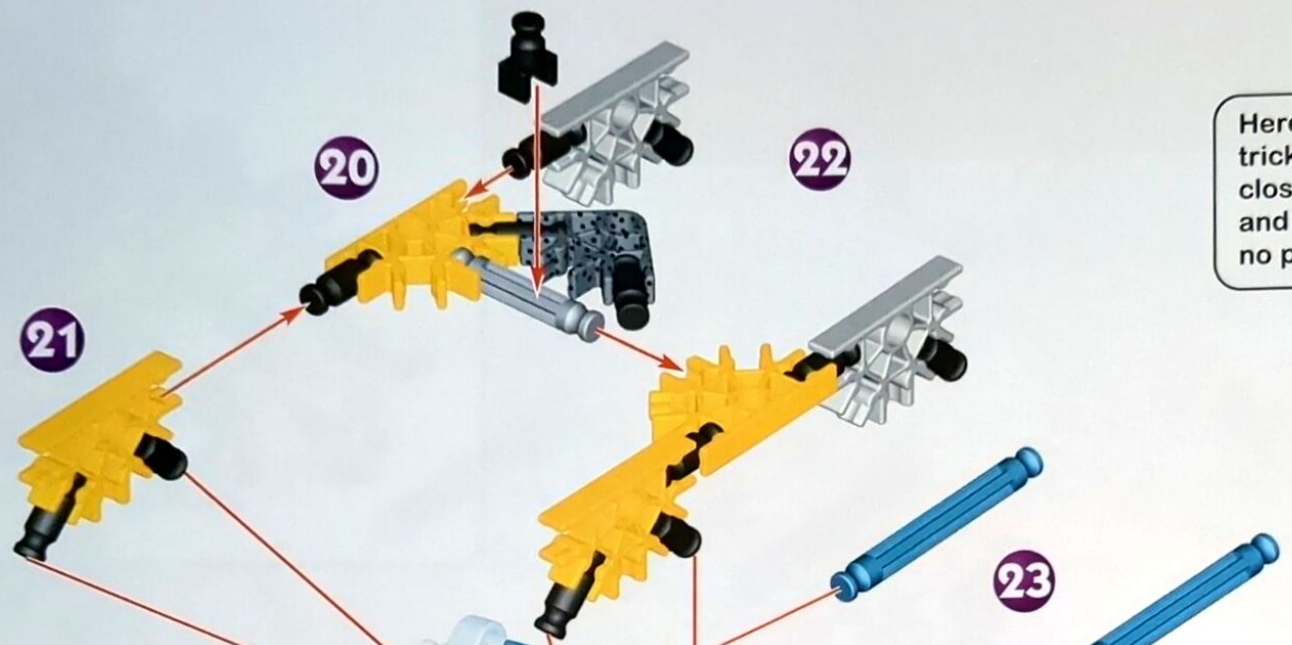

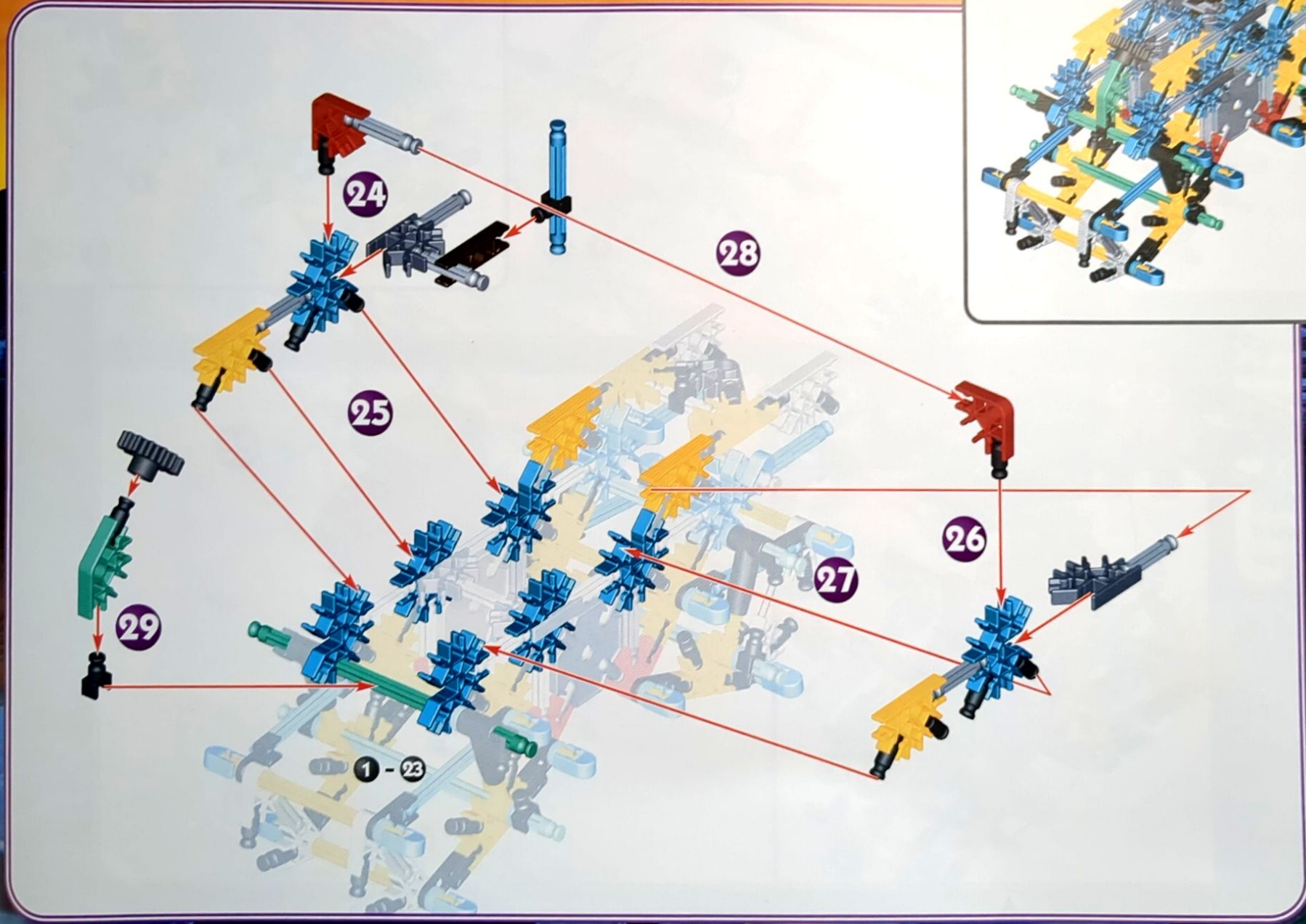

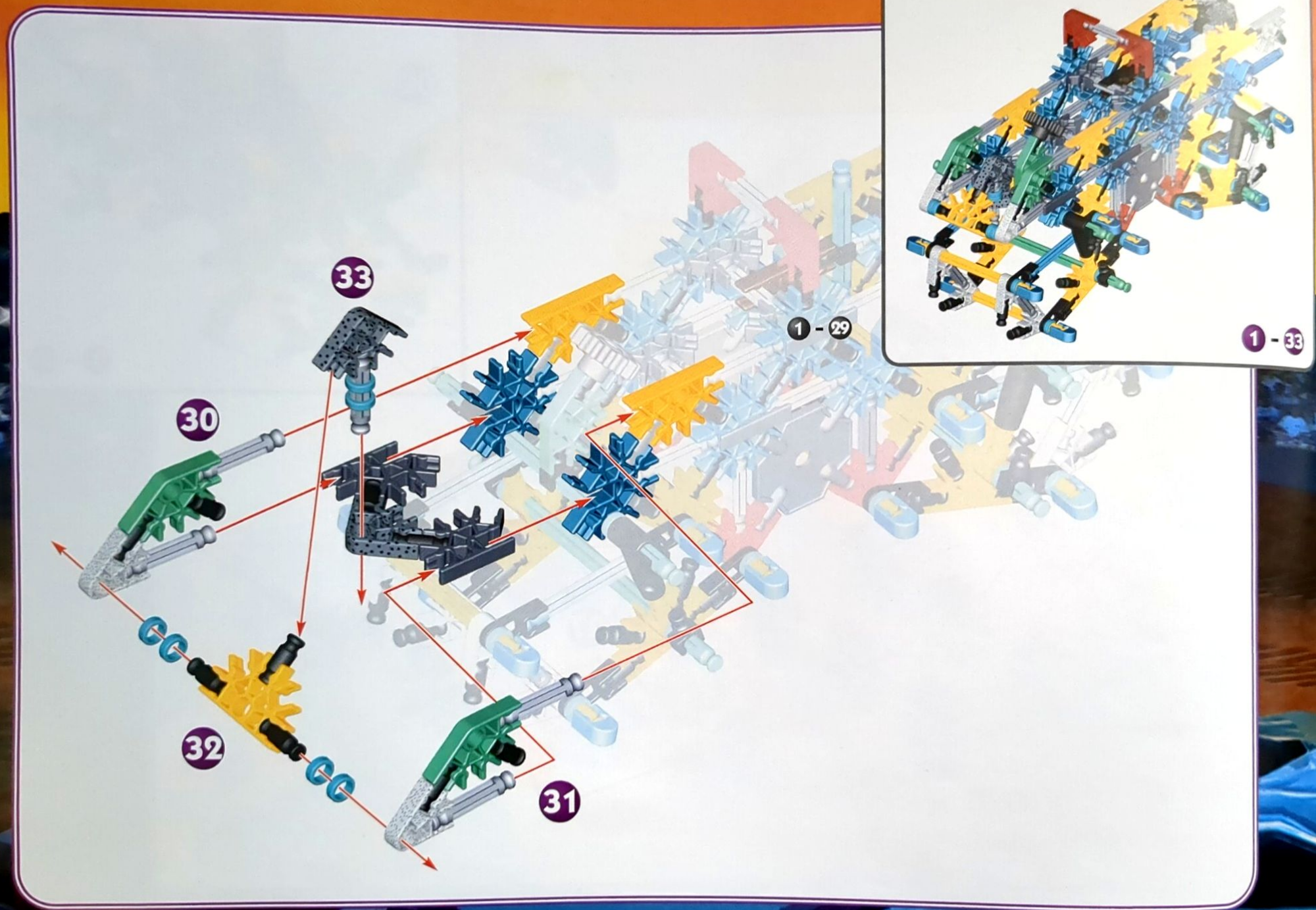

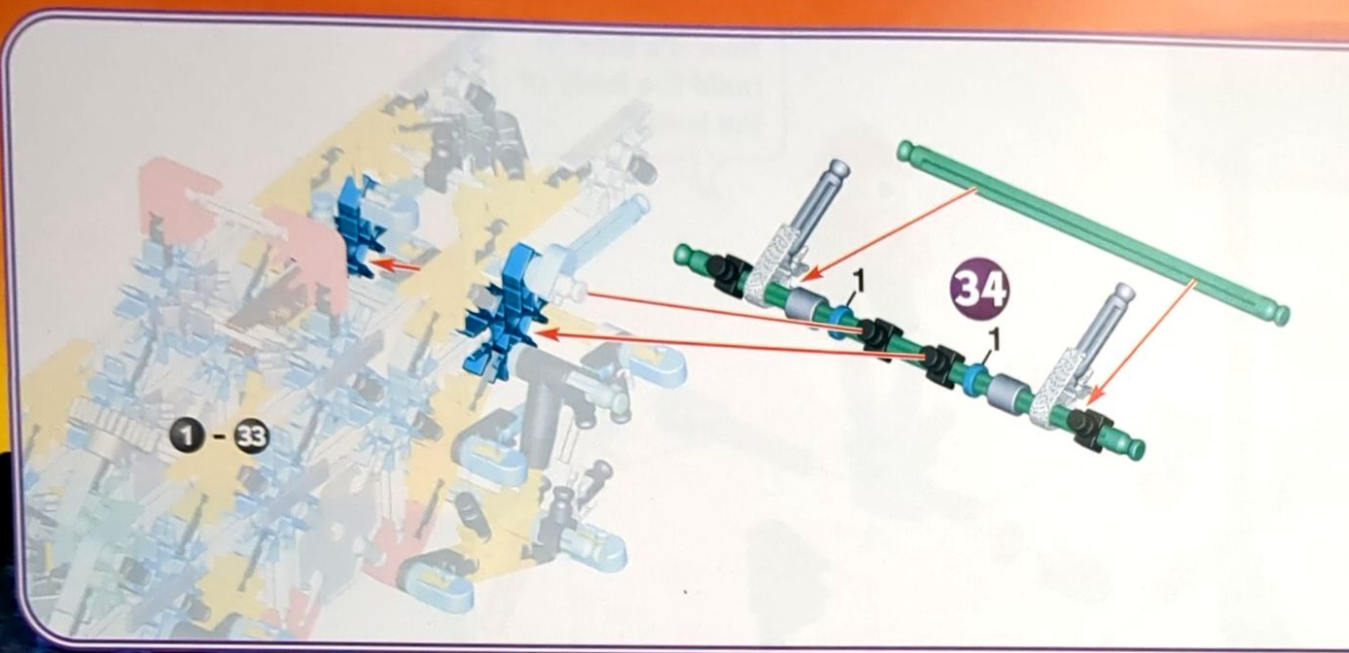

Great job! You just finished the "chassis". (That's pronounced "chass-y".) The chassis is the part of the truck that has the suspension.

Now it's time to build the body of the truck!

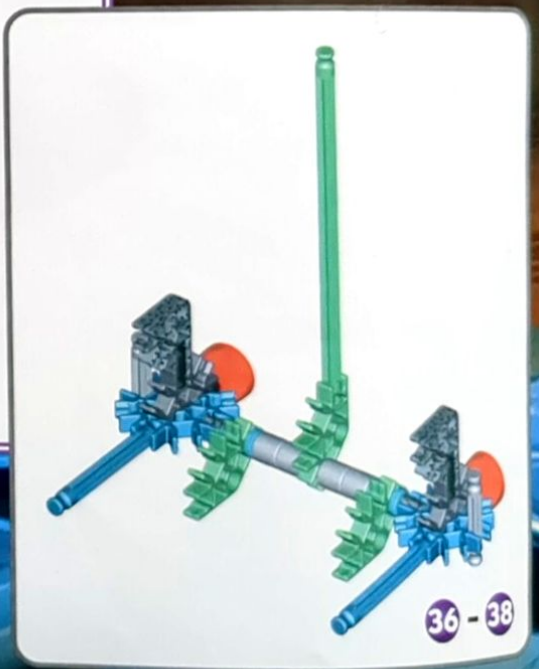
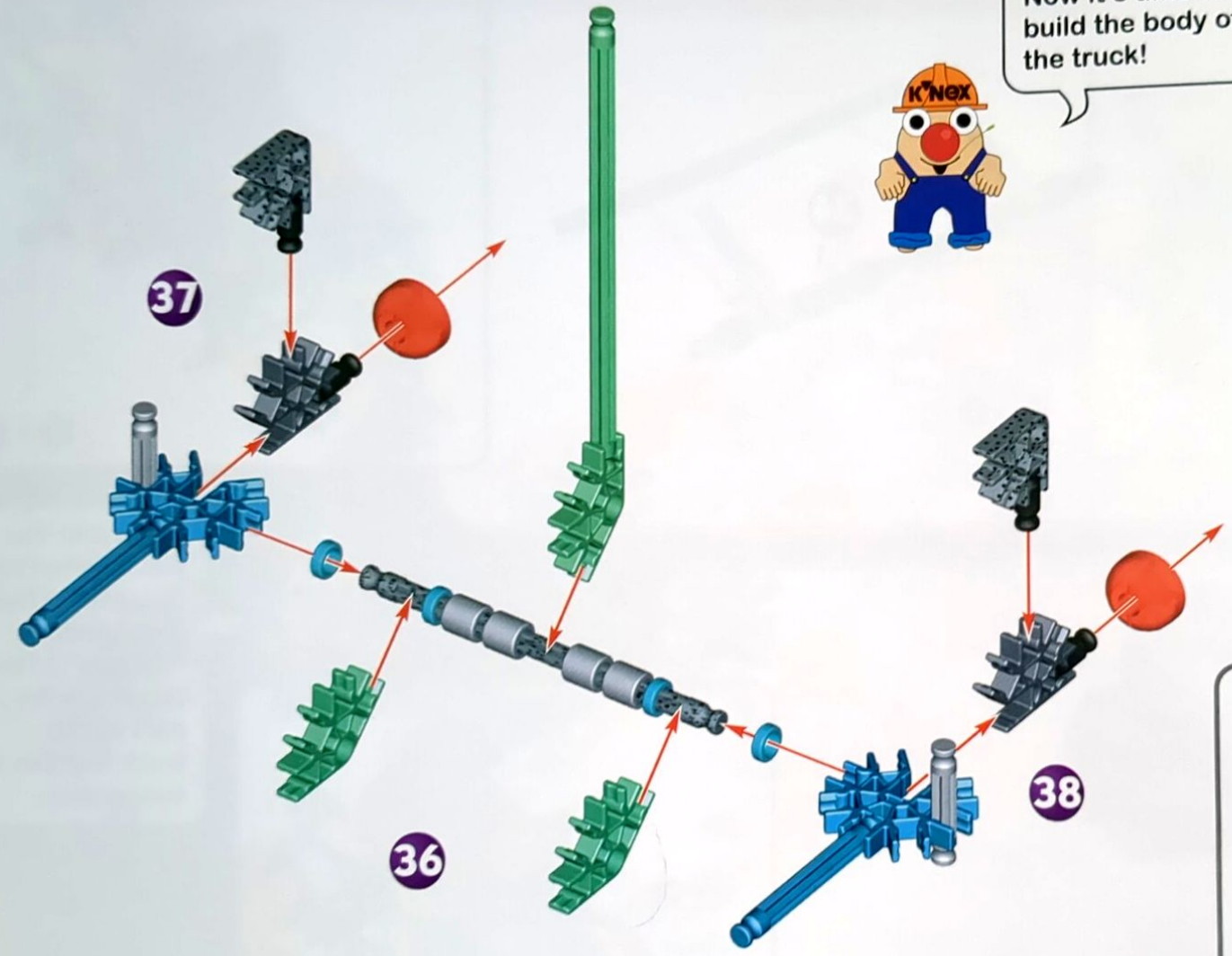

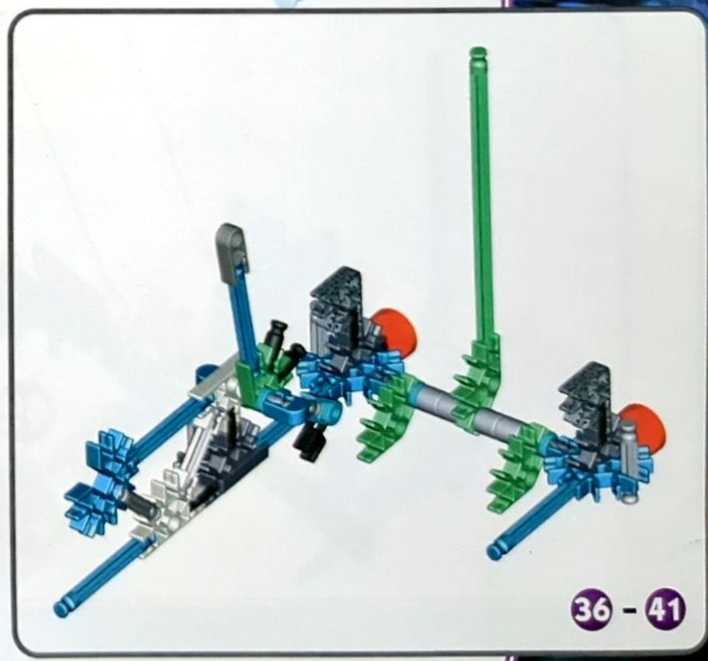
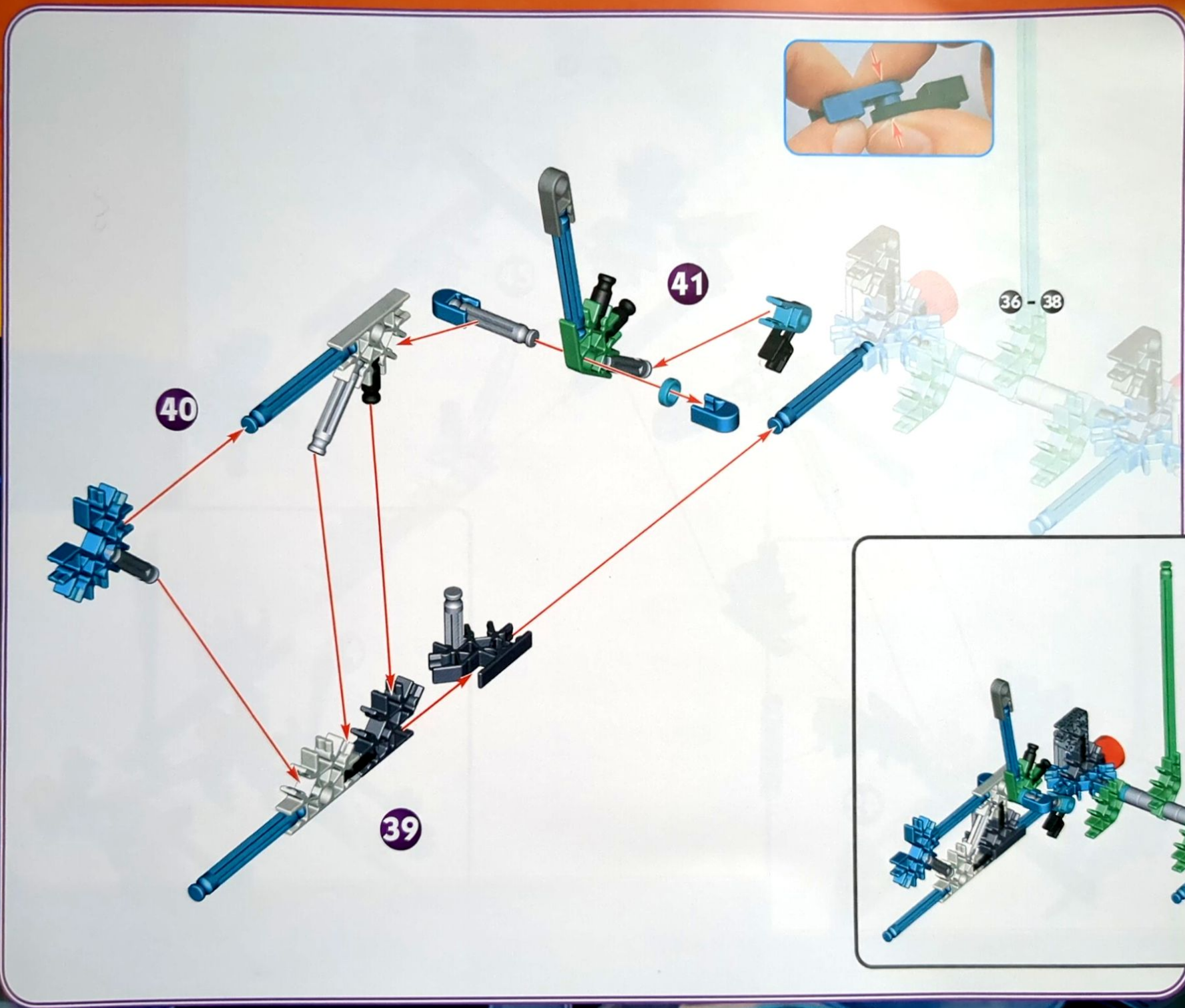

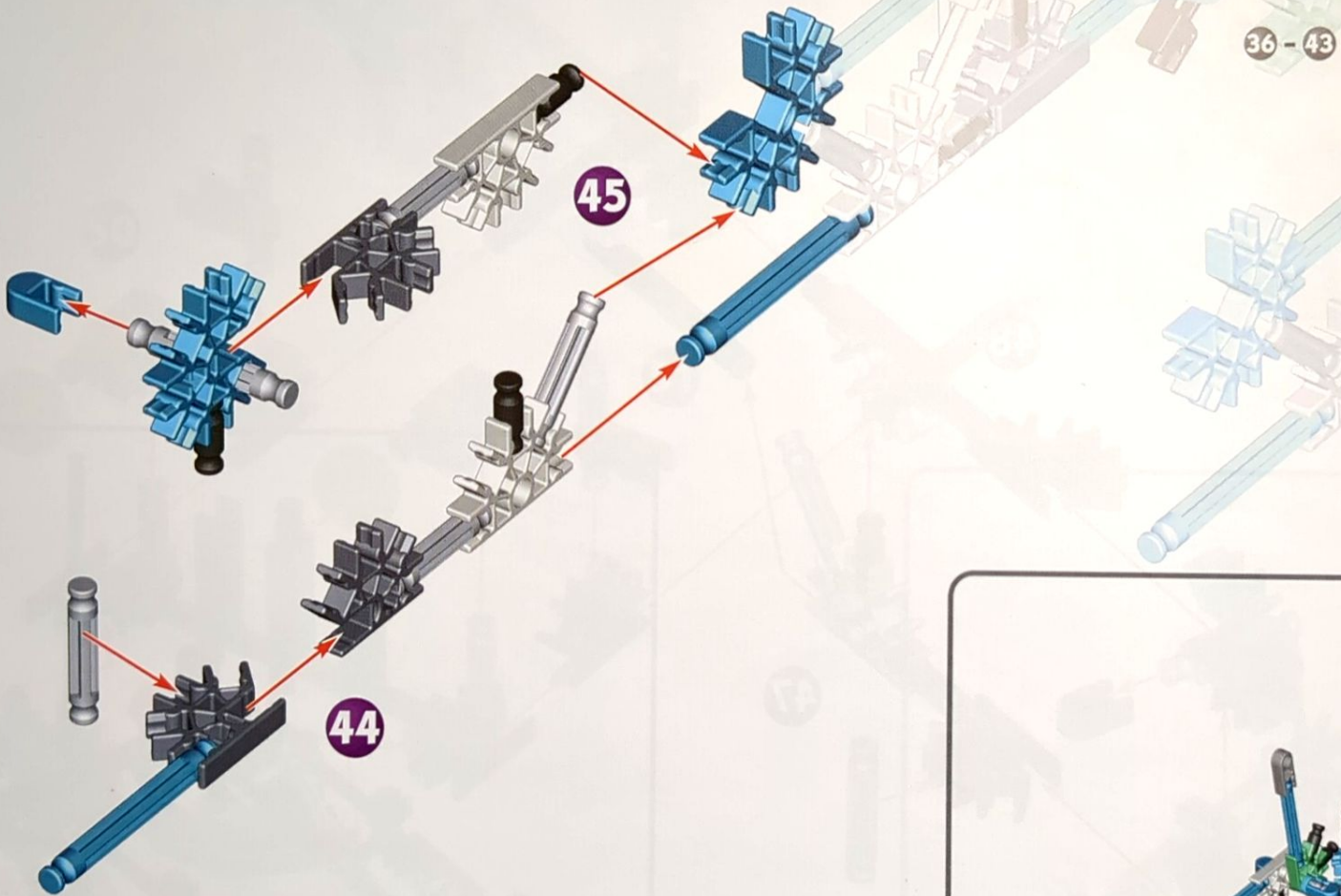

36 - 43

45

44

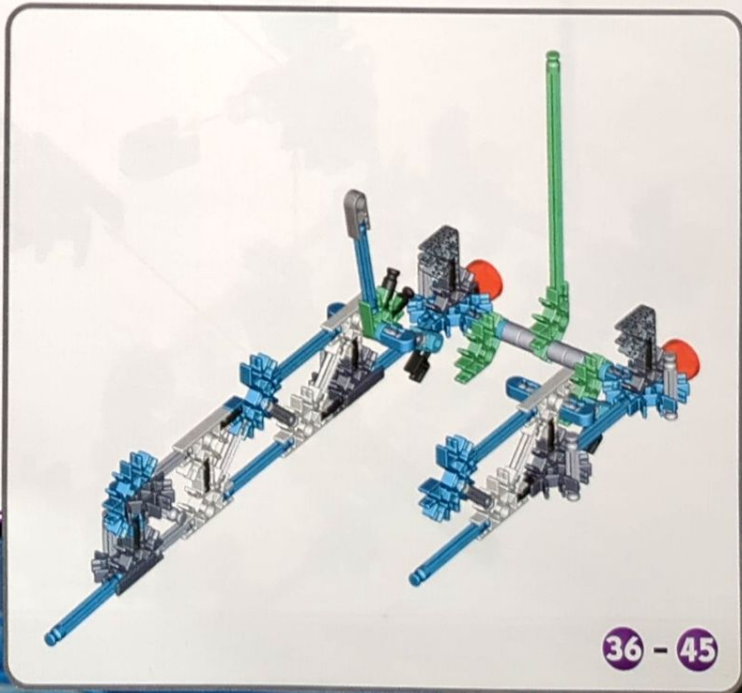

36 - 45

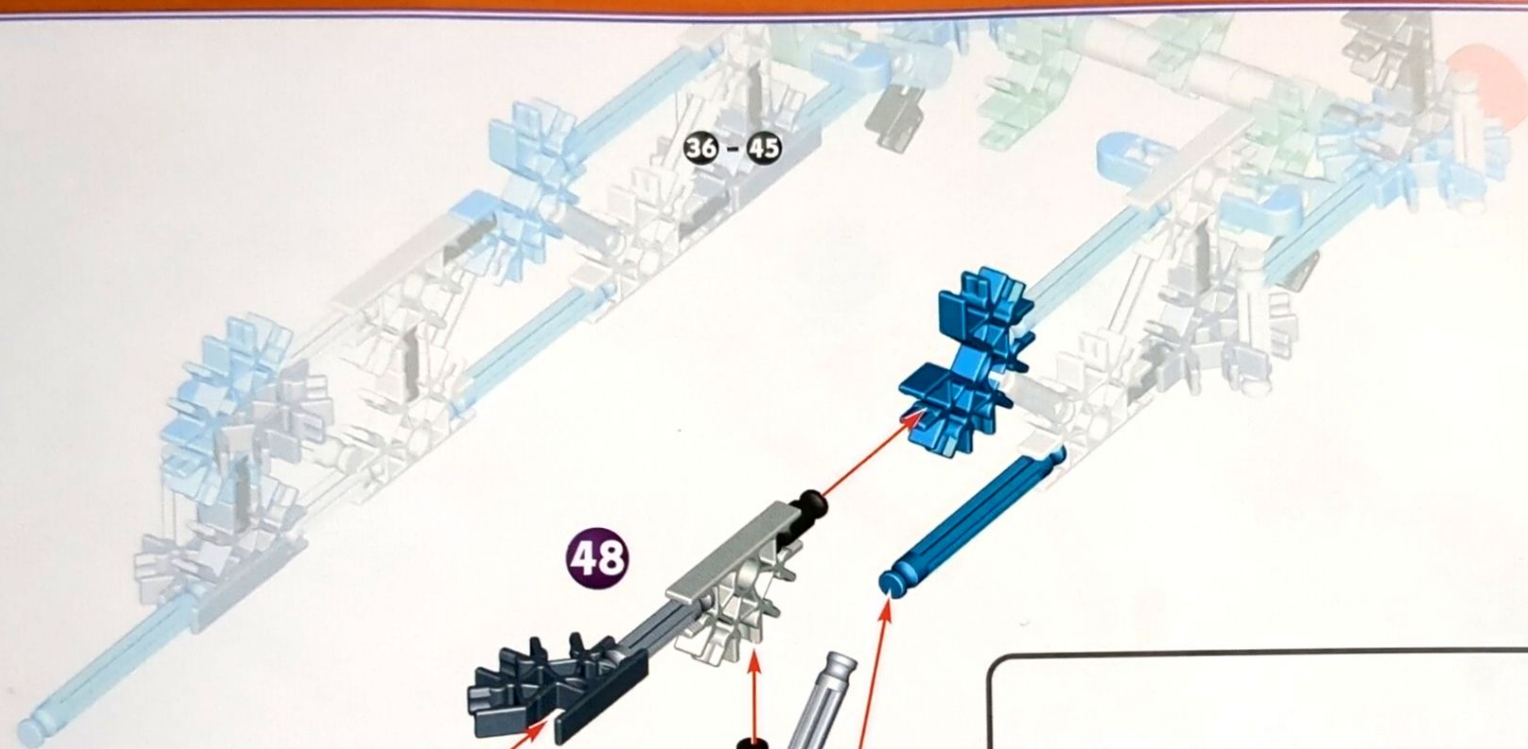

36 - 48

50

51

49

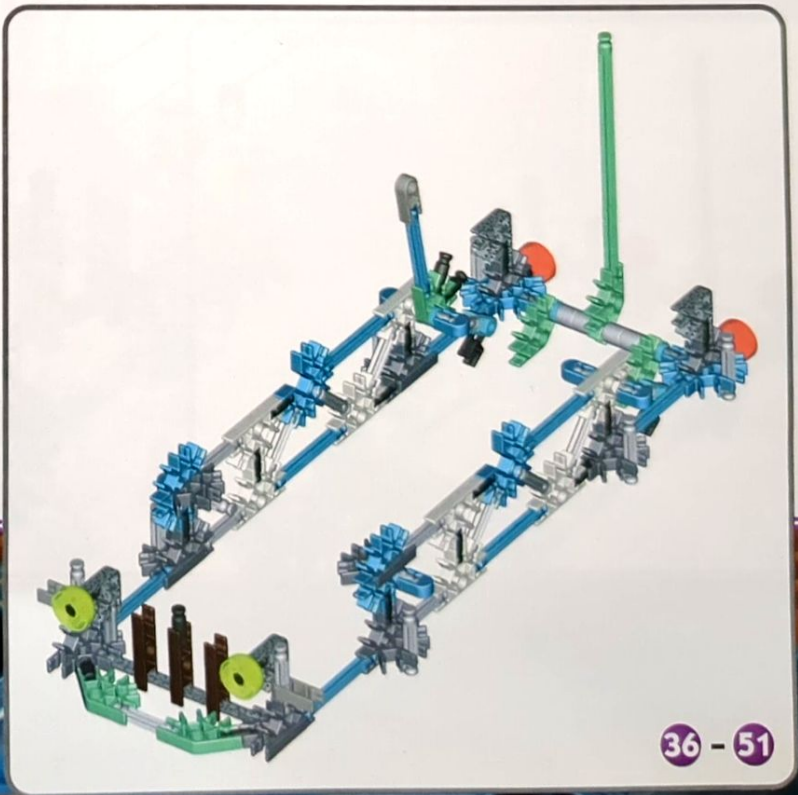

36 - 51

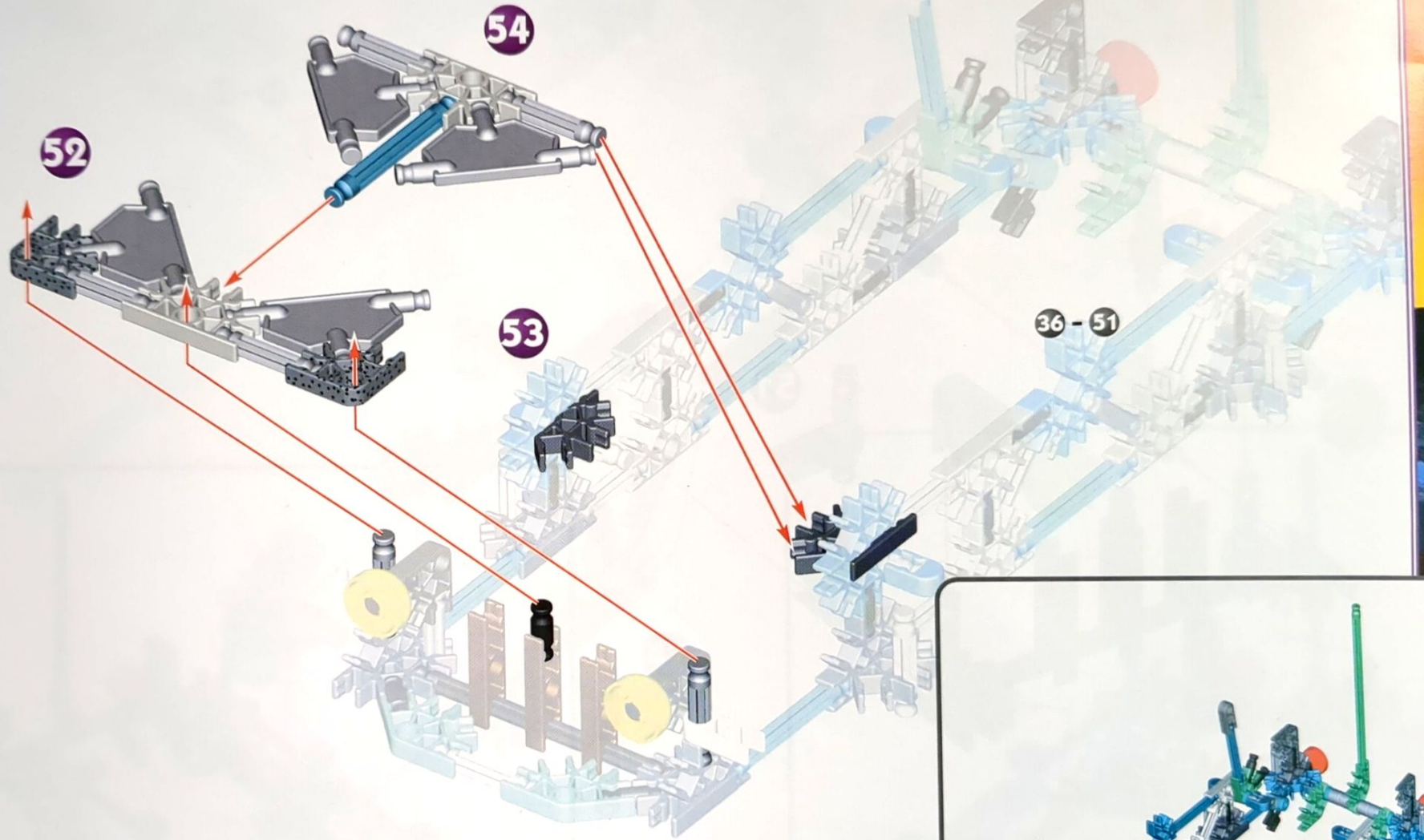

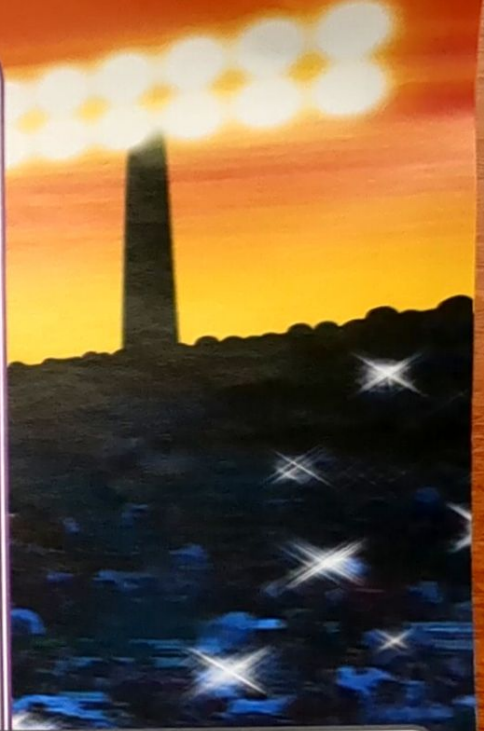
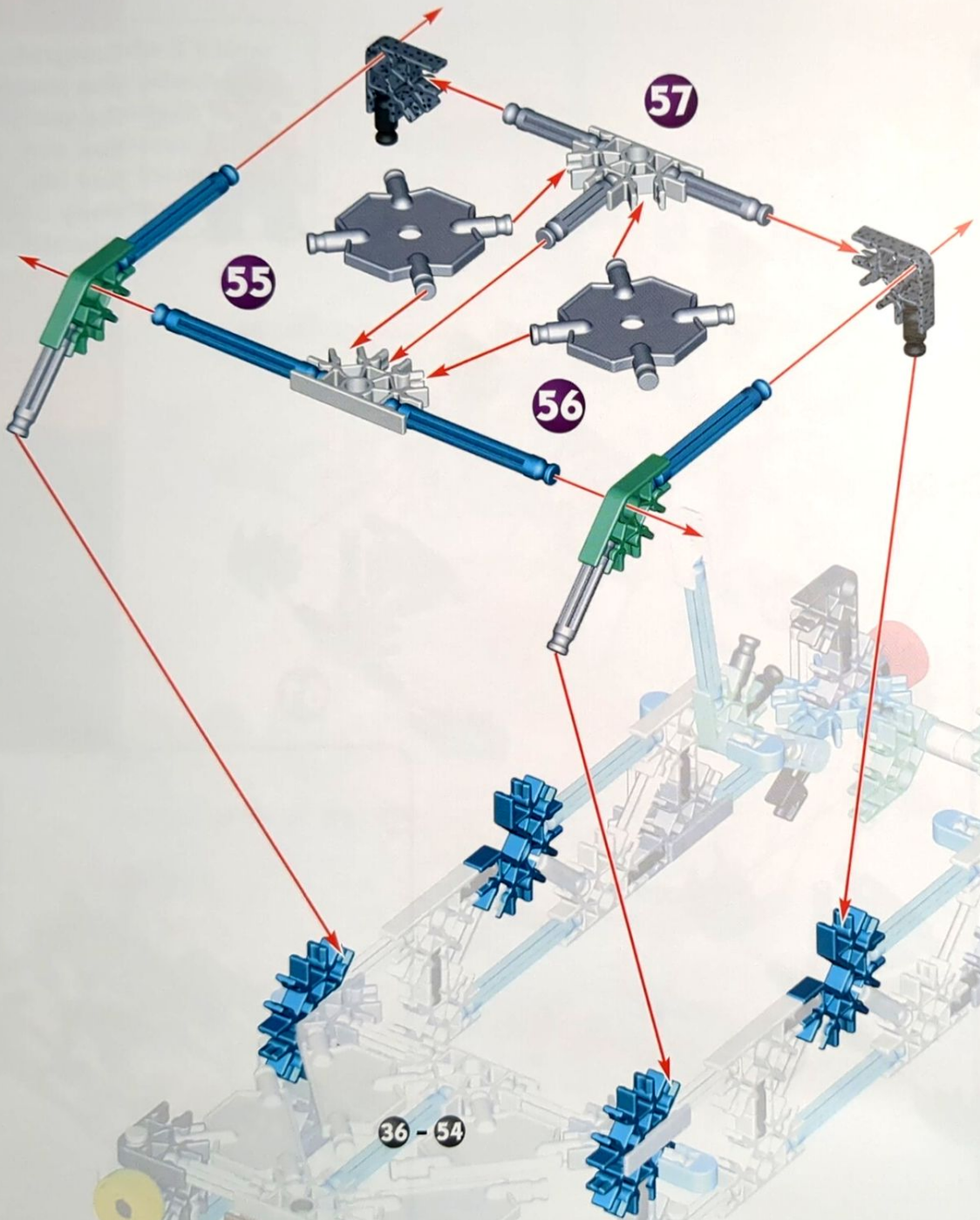



Congratulations, you just finished the body! As you can see, it looks just like the body on a real monster truck!

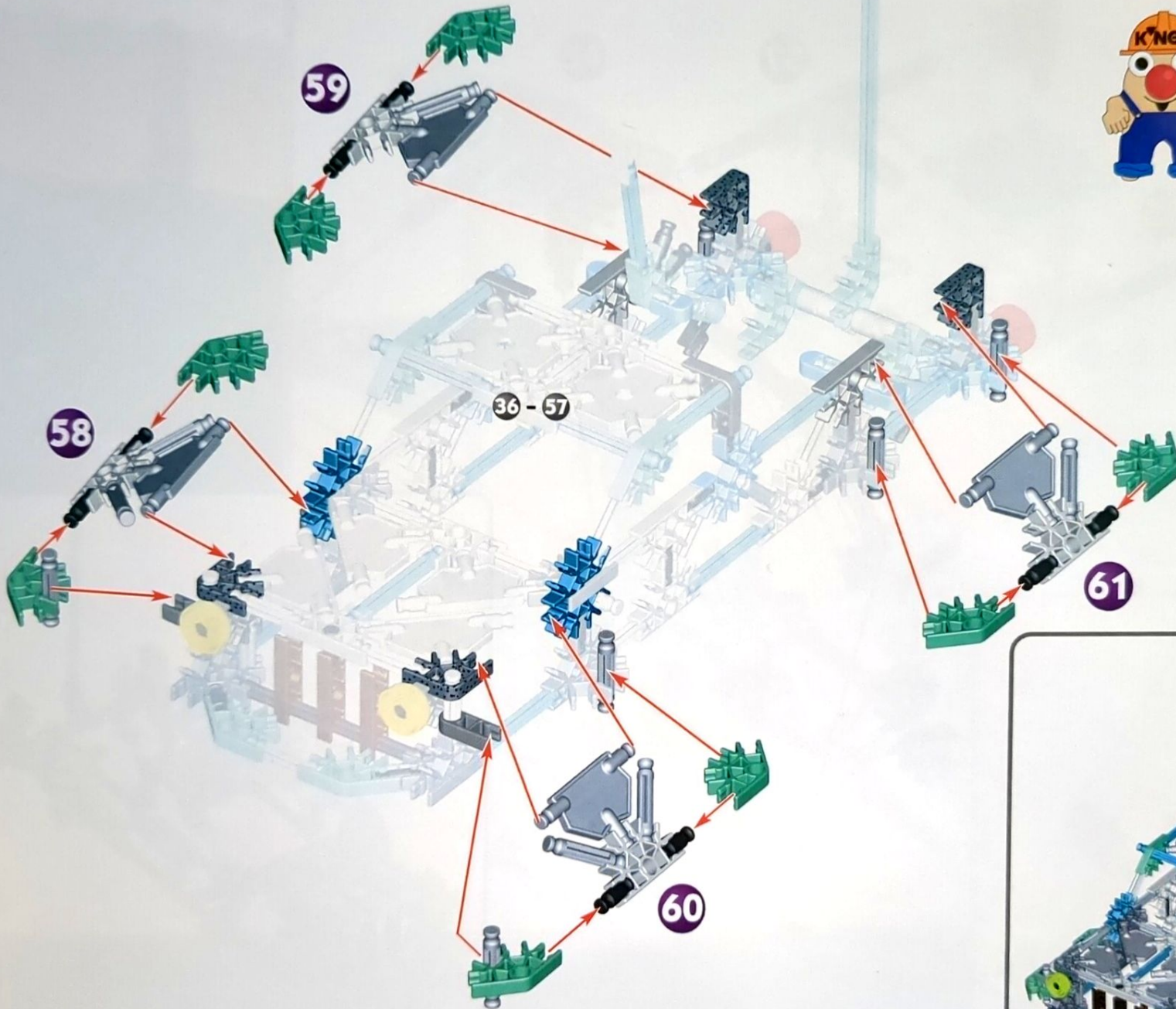



Now it's time to attach the body to the chassis! Hang in there, you're almost done!

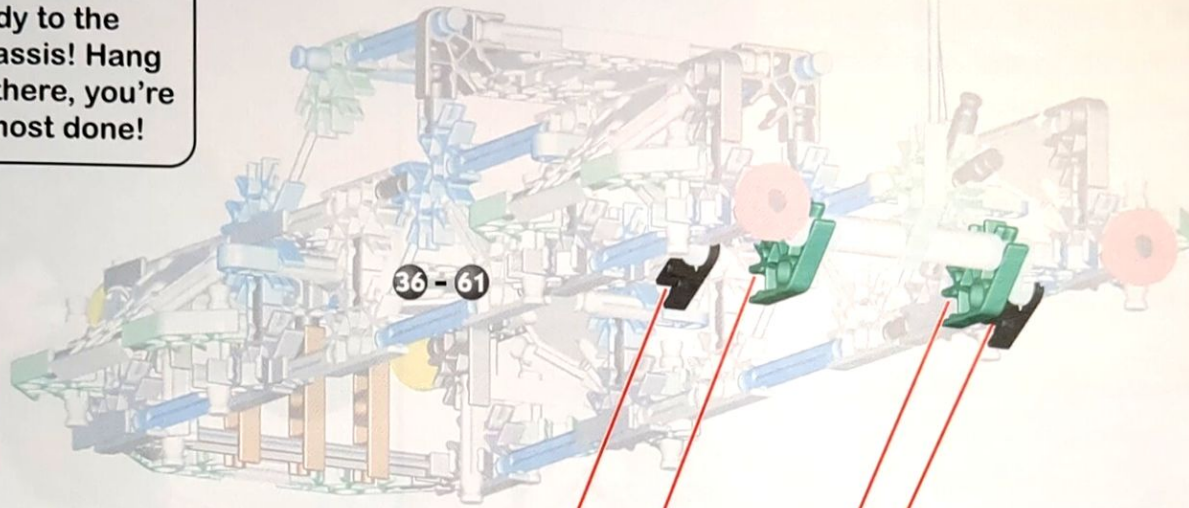

36 - 61

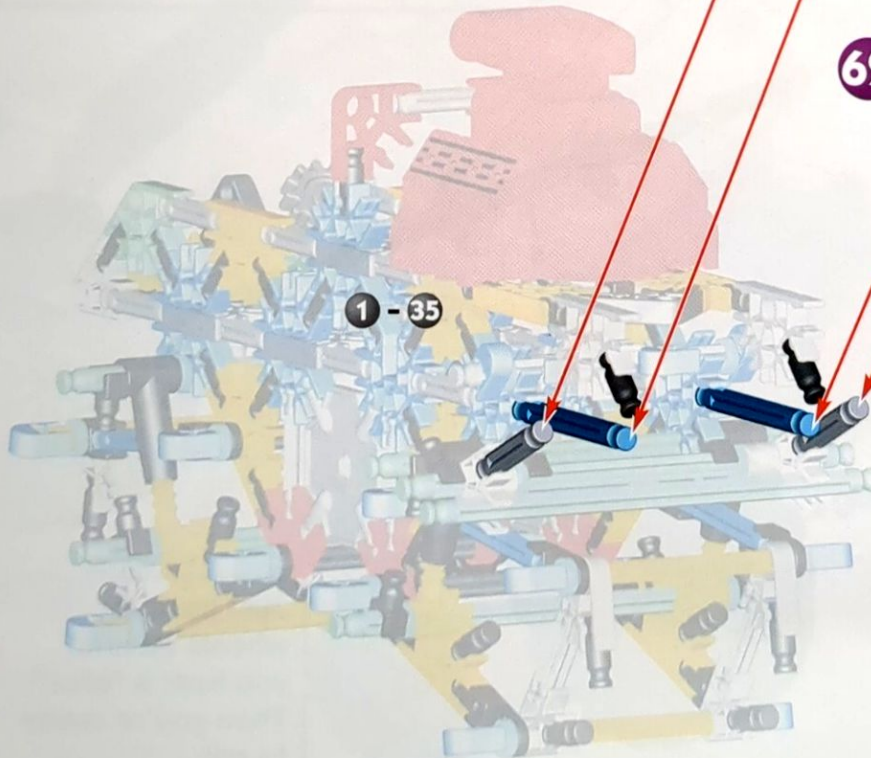

1 - 35

62

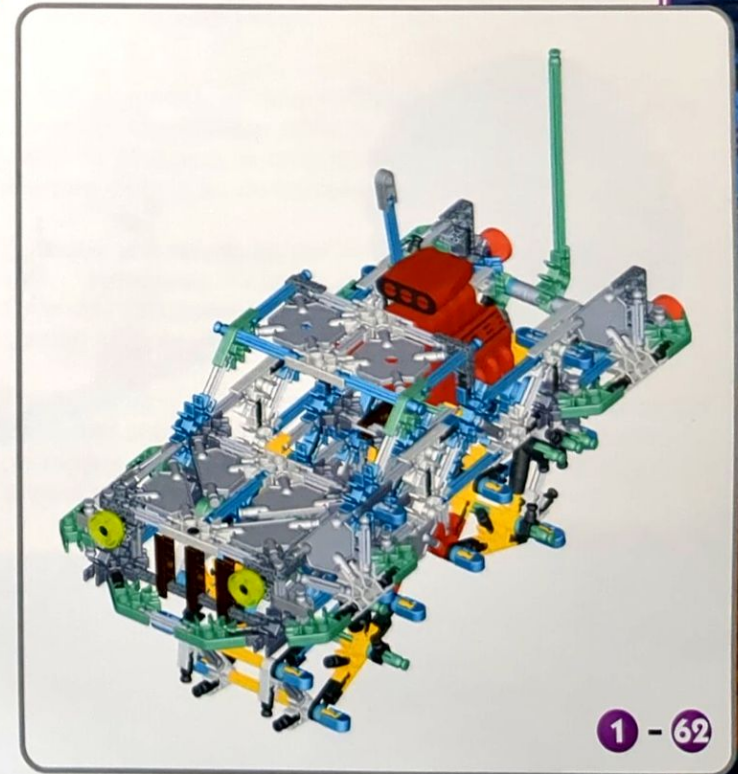

1 - 62

Cool Ways to play!

Once built, OVERDRIVE is designed to take a beating, so there are lots of different ways you can play with it! Try these cool ideas, and then come up with your own:

- Flag: Cut out and paste or tape the flag around the metallic green Rod.
- Drapeau: Découpe le drapeau et colle-le ou attache-le avec du ruban autour de la tige verte métallique.

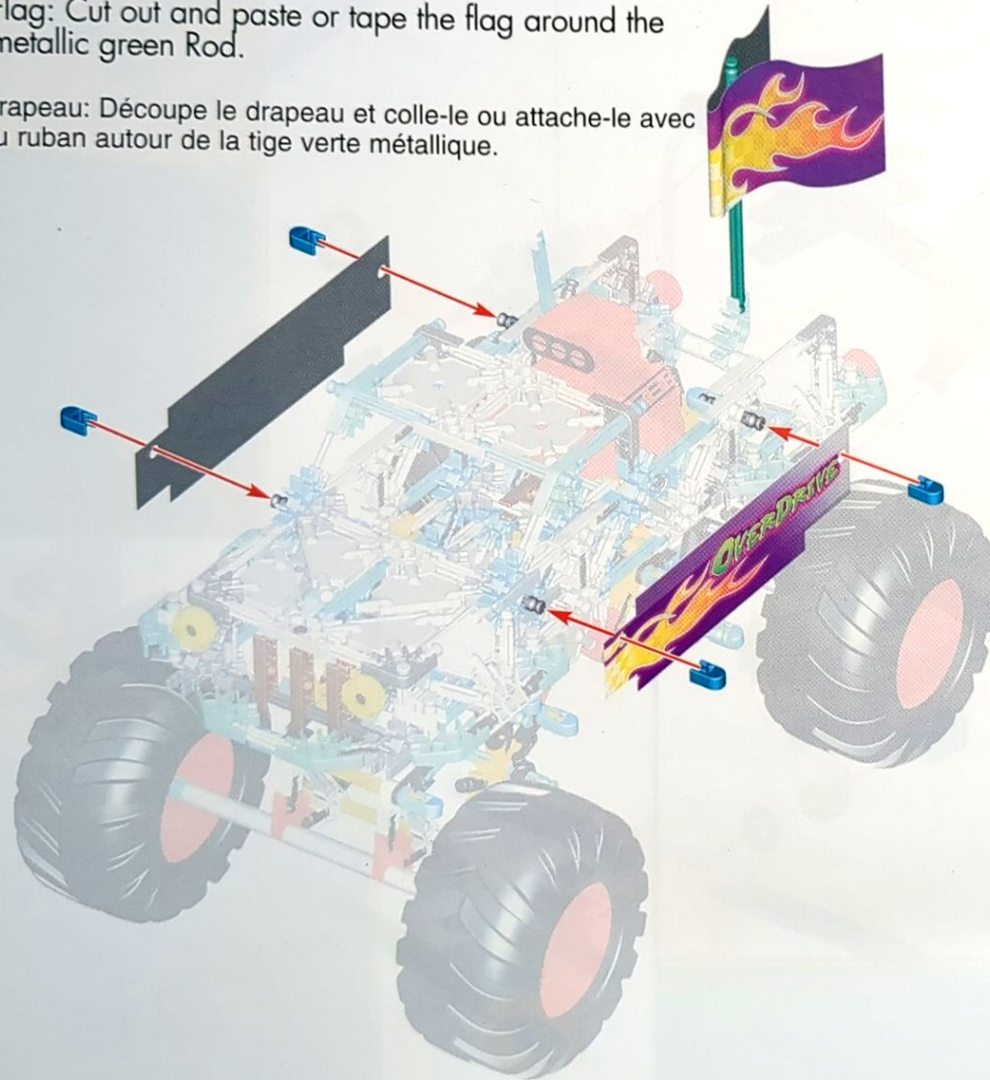

- Make a ramp out of cardboard, push your truck over it, and watch as the suspension cushions the landing... just like a real Monster Truck!
- Trace the shape of the racing graphic panels onto white paper. Then try designing your own graphic panels and put them on your model for a personalized look!

Une fois assemblé, le camion OVERDRIVE est conçu pour résister aux contraintes; ainsi, tu peux jouer avec ce camion de plusieurs façons. Voici quelques suggestions superbes, puis, à toi de formuler tes propres idées:

- Fabrique une rampe de carton et lance le camion dans le vide... et regarde comment la suspension absorbe la force de l'atterrissage ... juste comme dans le cas d'un camion Monster Truck réel!
- Trace la forme des panneaux à graphiques de course sur du papier blanc. Puis, essaie de concevoir tes propres panneaux et attache-les à ton modèle pour créer un aspect personnalisé!

POWER SURGE

- Monster Truck attitude with Low-Rider style!



Adult Help is Recommended

This is "Power Surge"! Follow me if you want to build this truck!

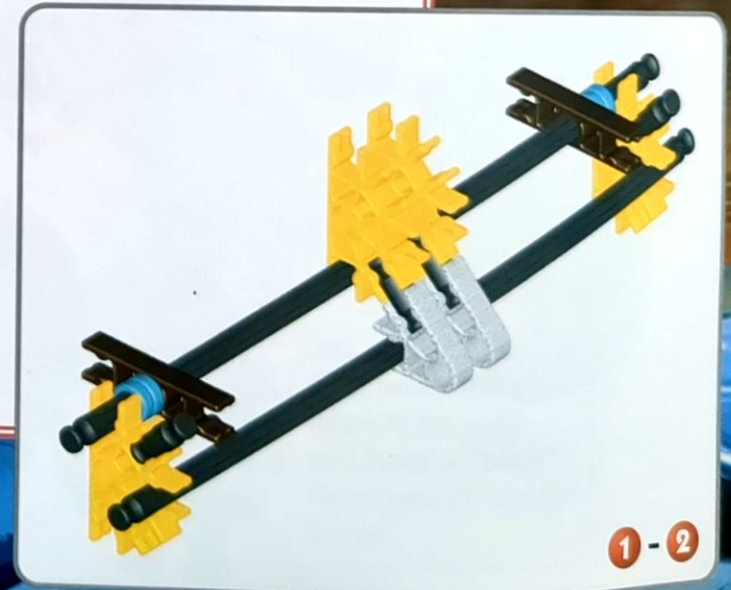
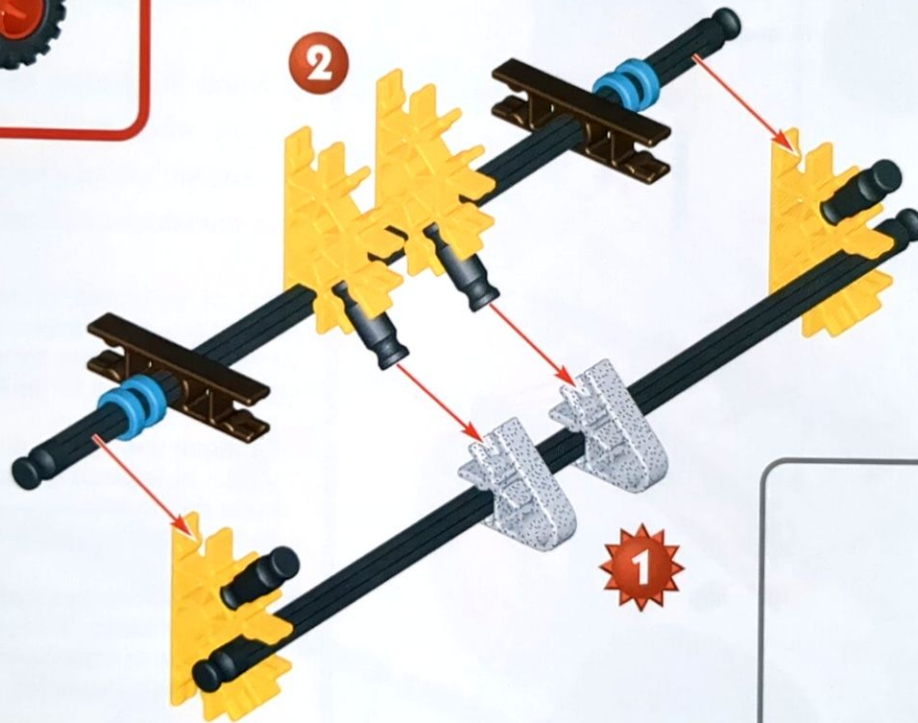

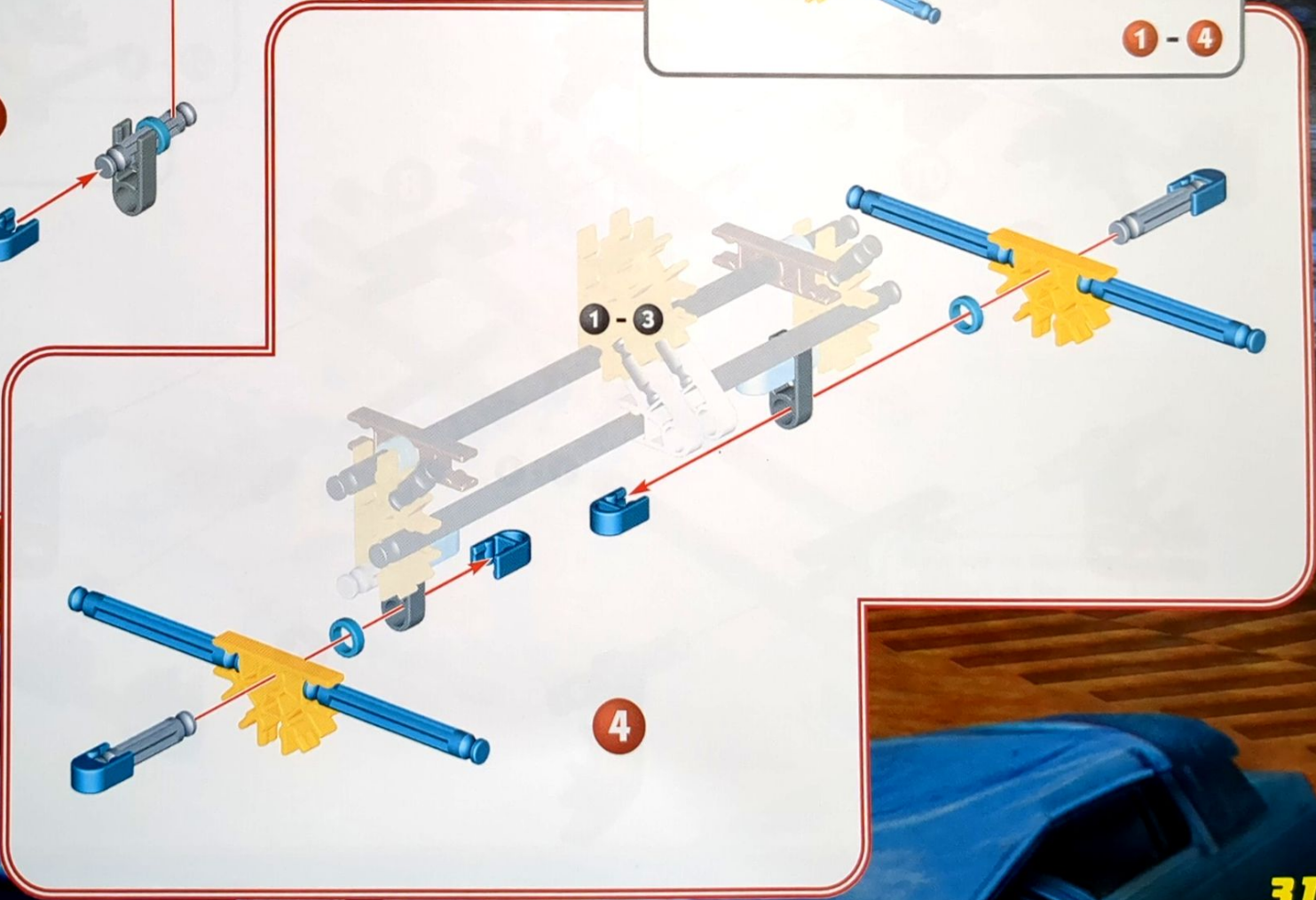
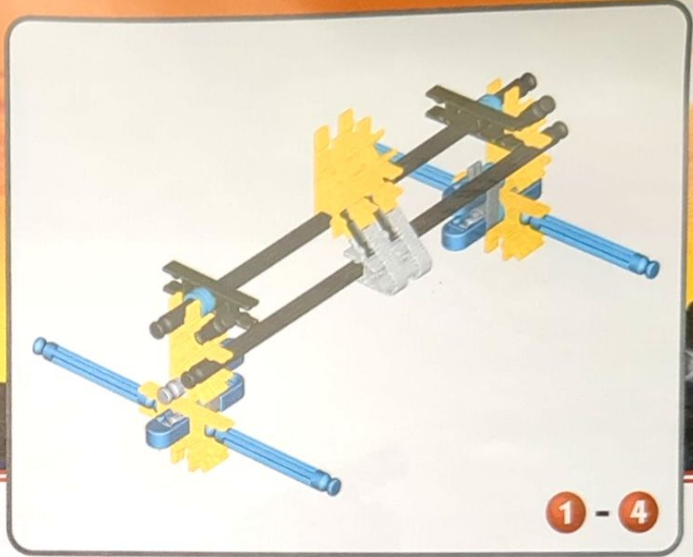
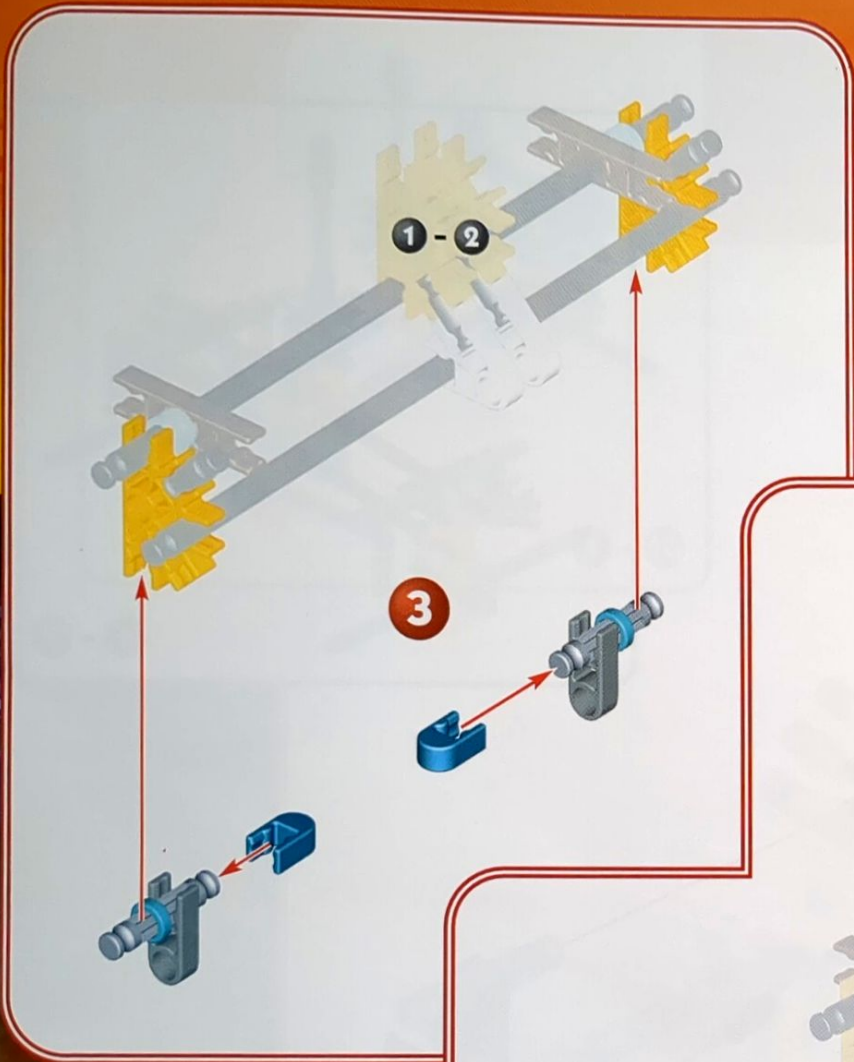

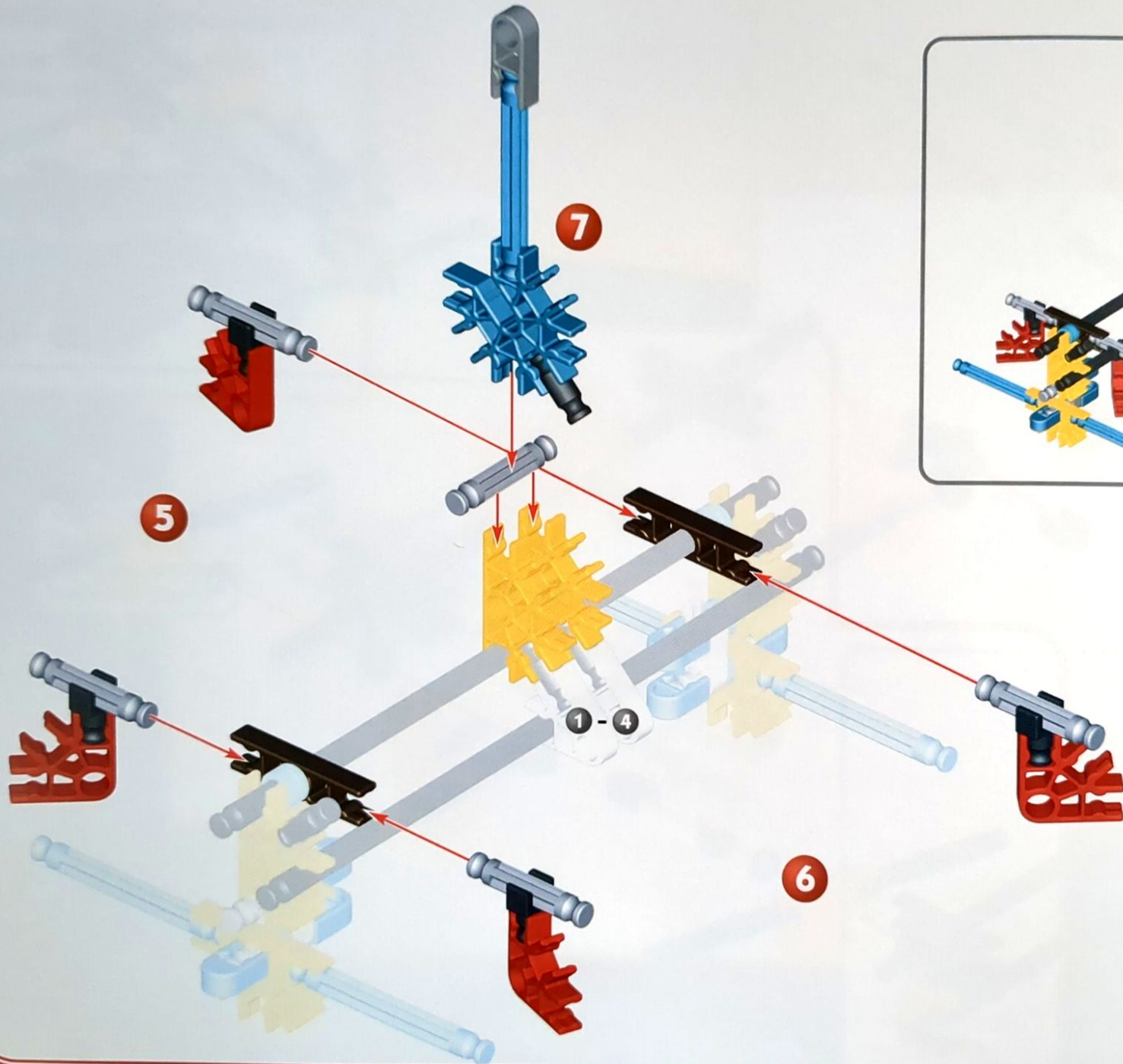

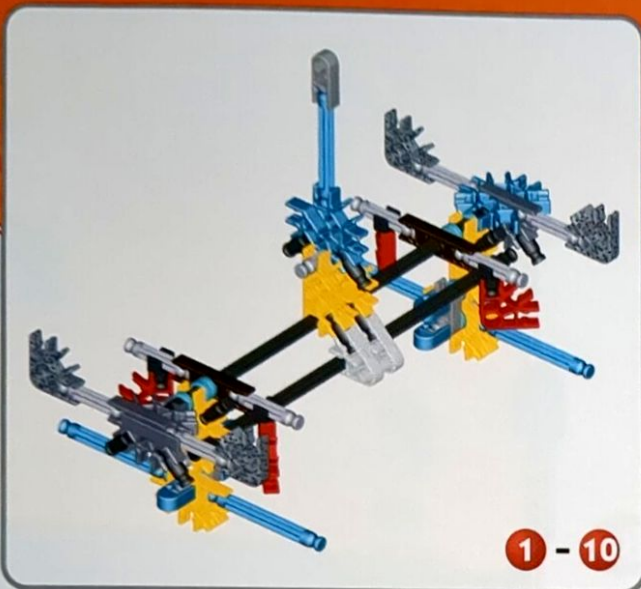

1 - 10

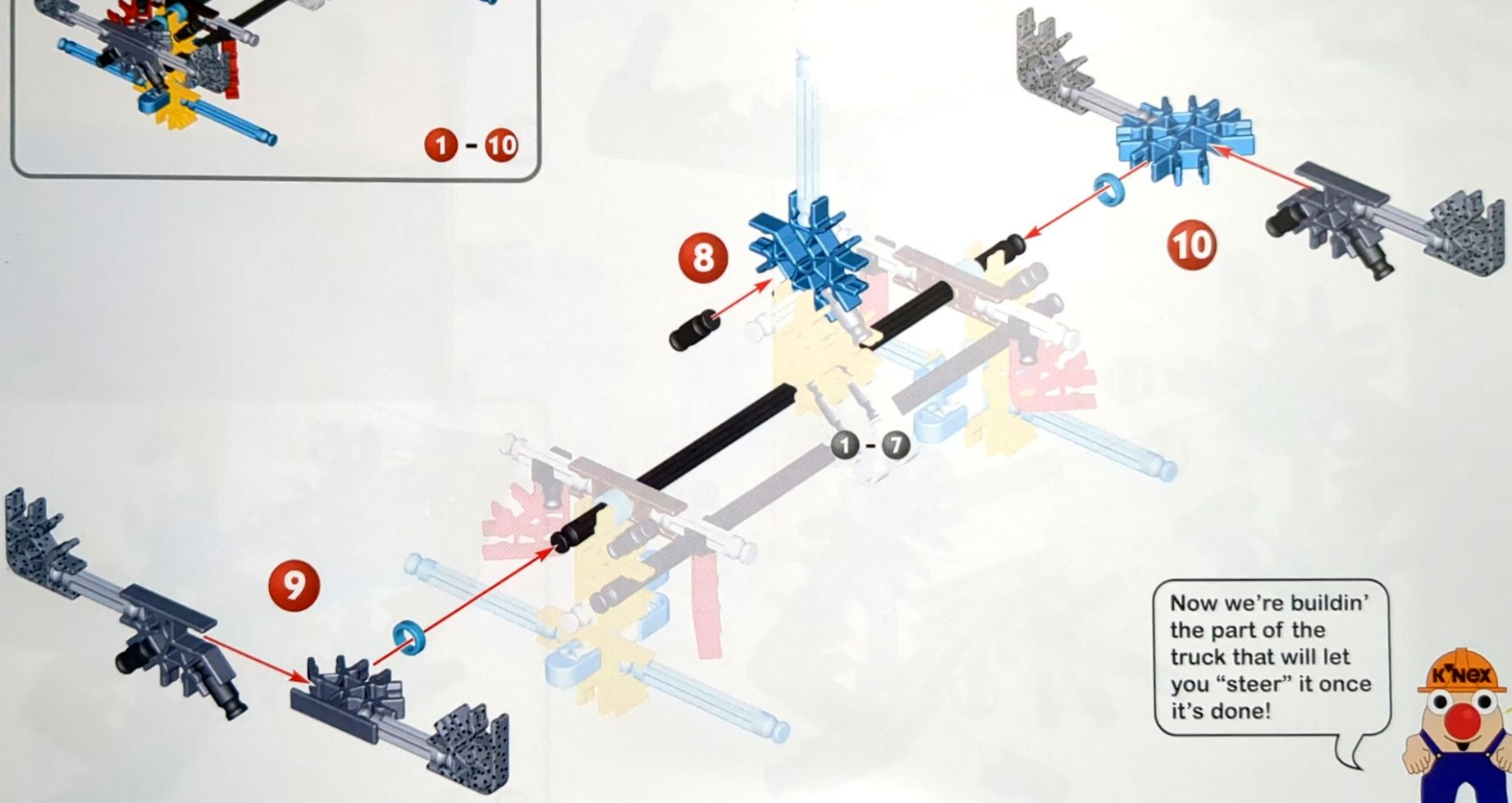

Now we're buildin' the part of the truck that will let you "steer" it once it's done!



This is the front axle of the truck.

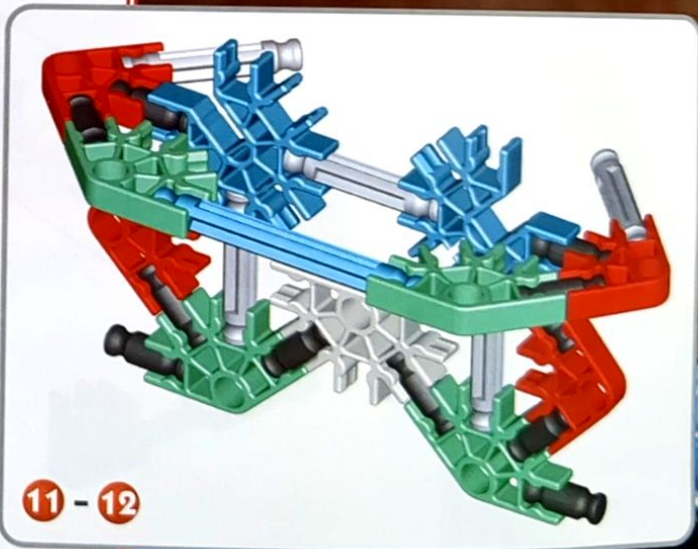
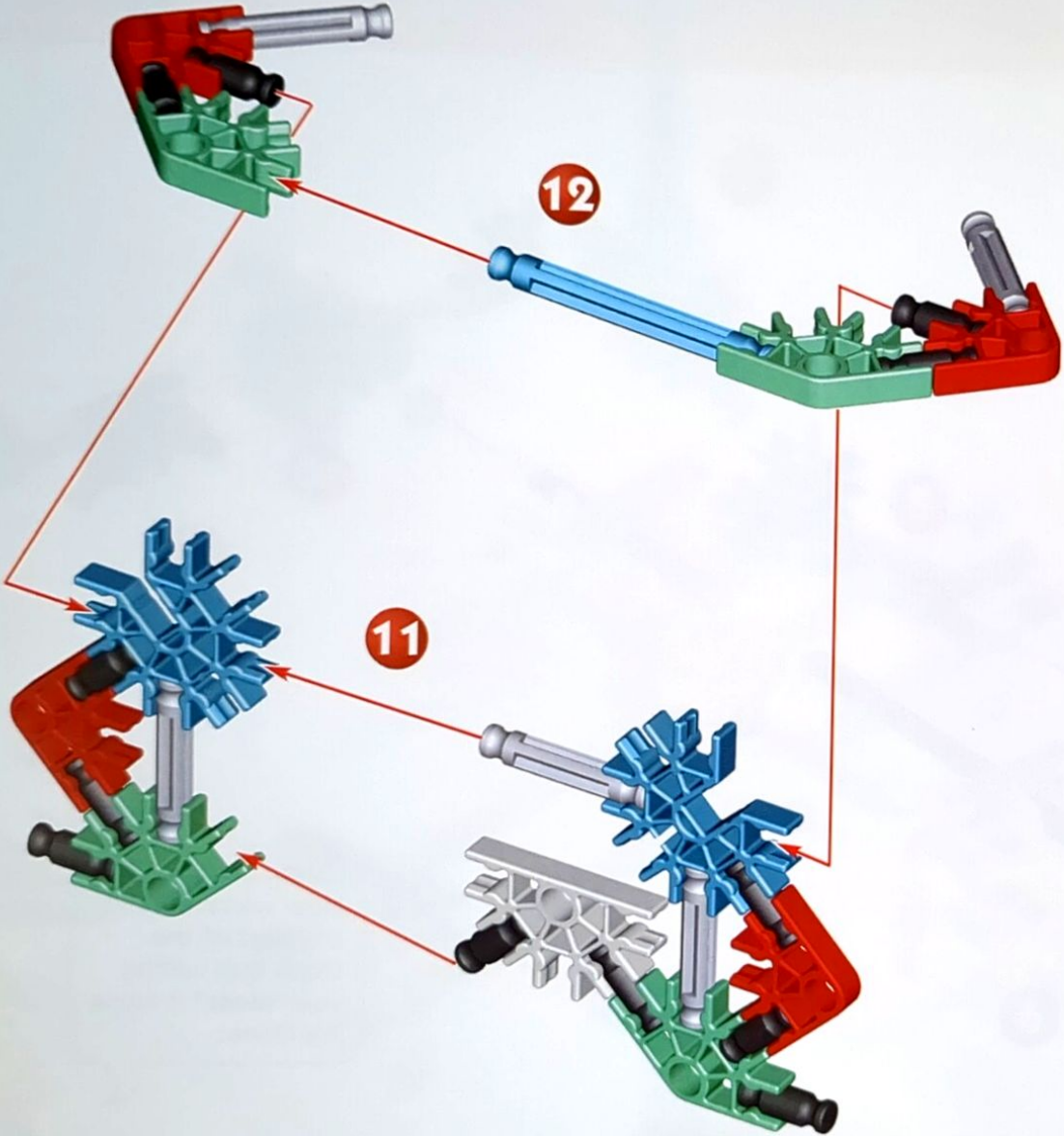

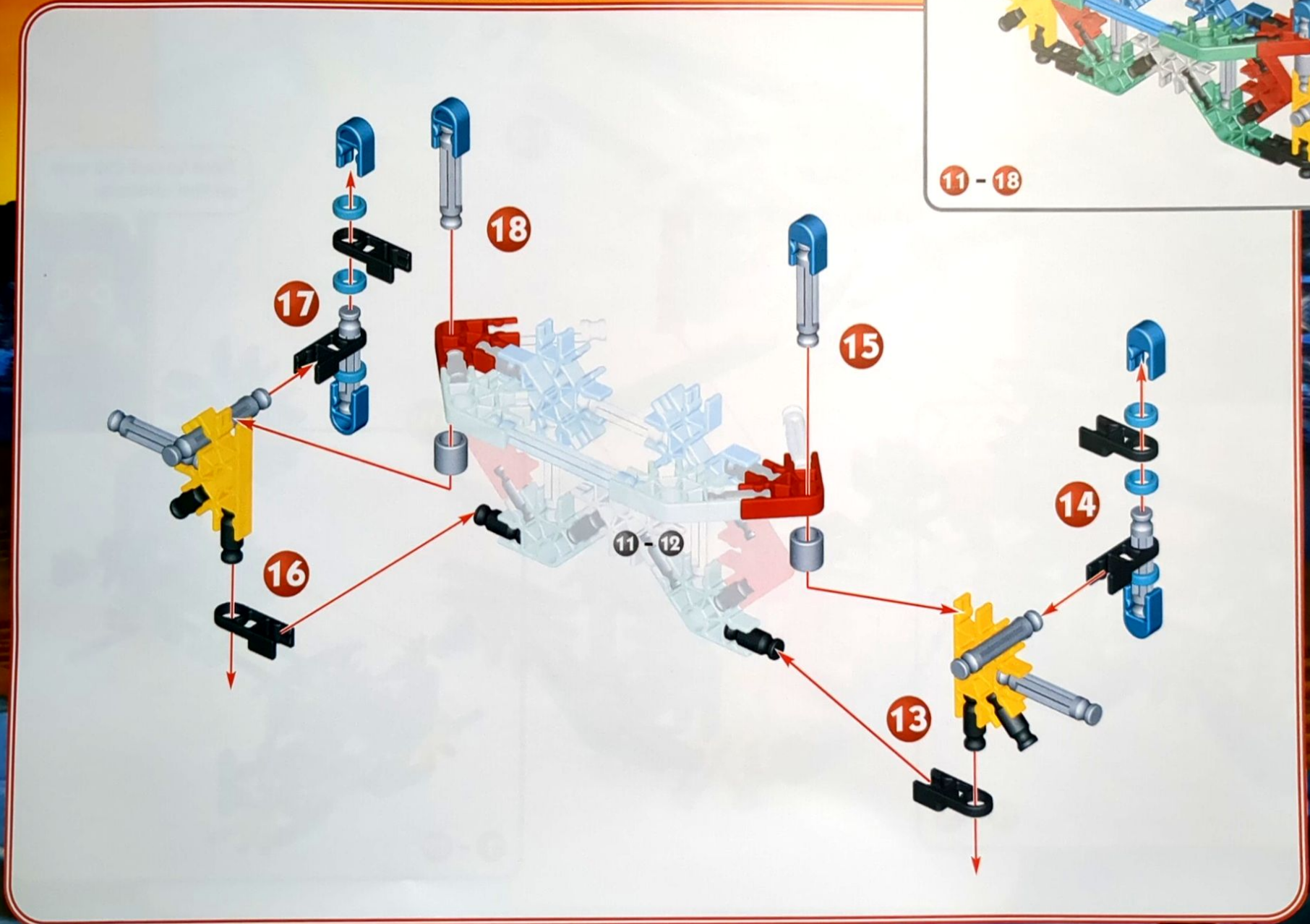

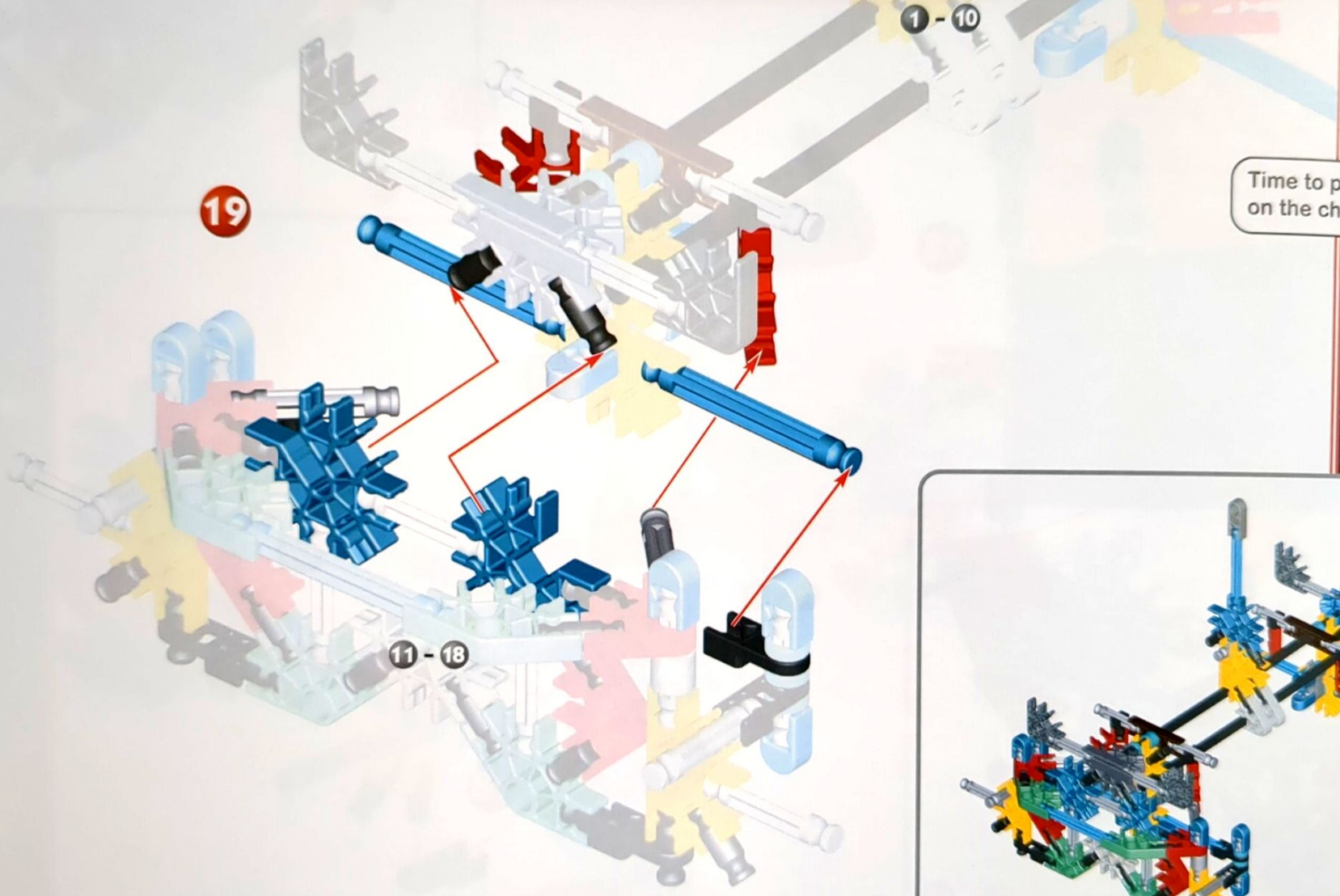

Time to put the axle on the chassis.



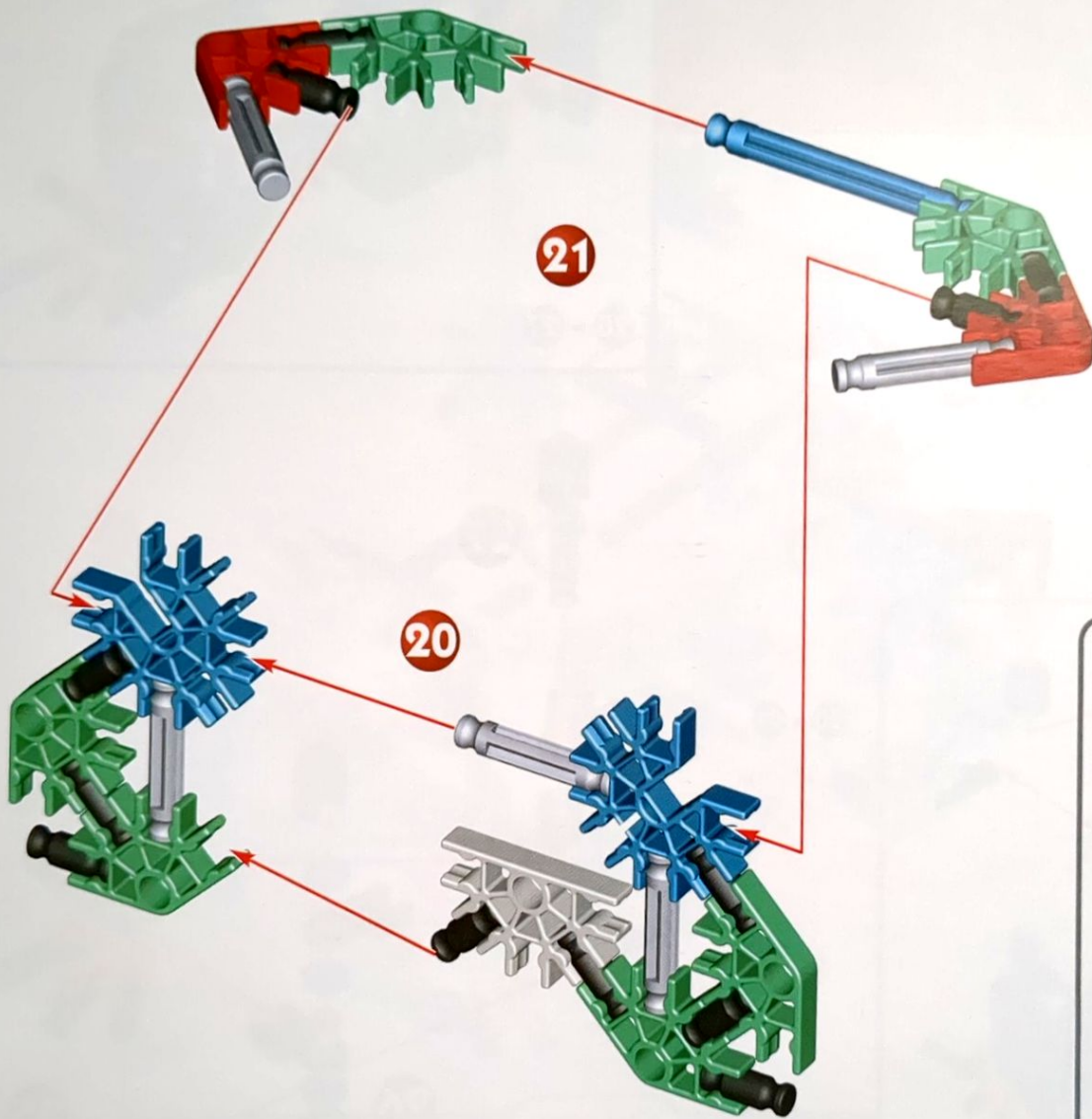

Great job, now let's do the same for the rear axle!

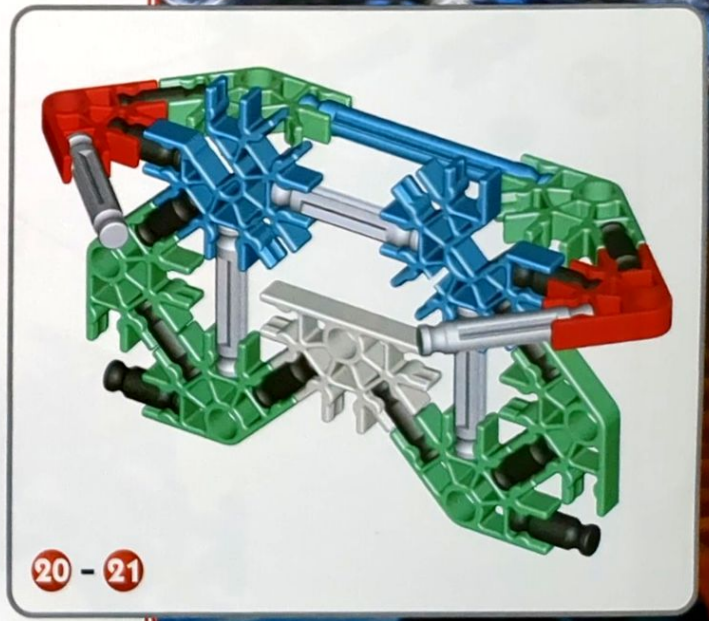

20 - 21

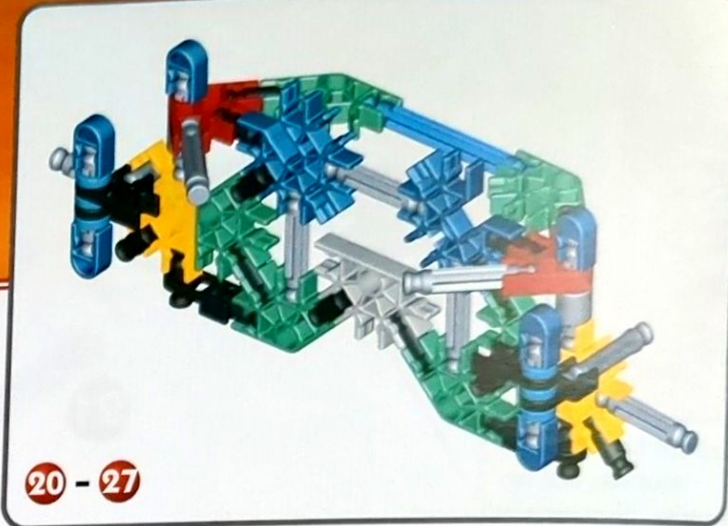

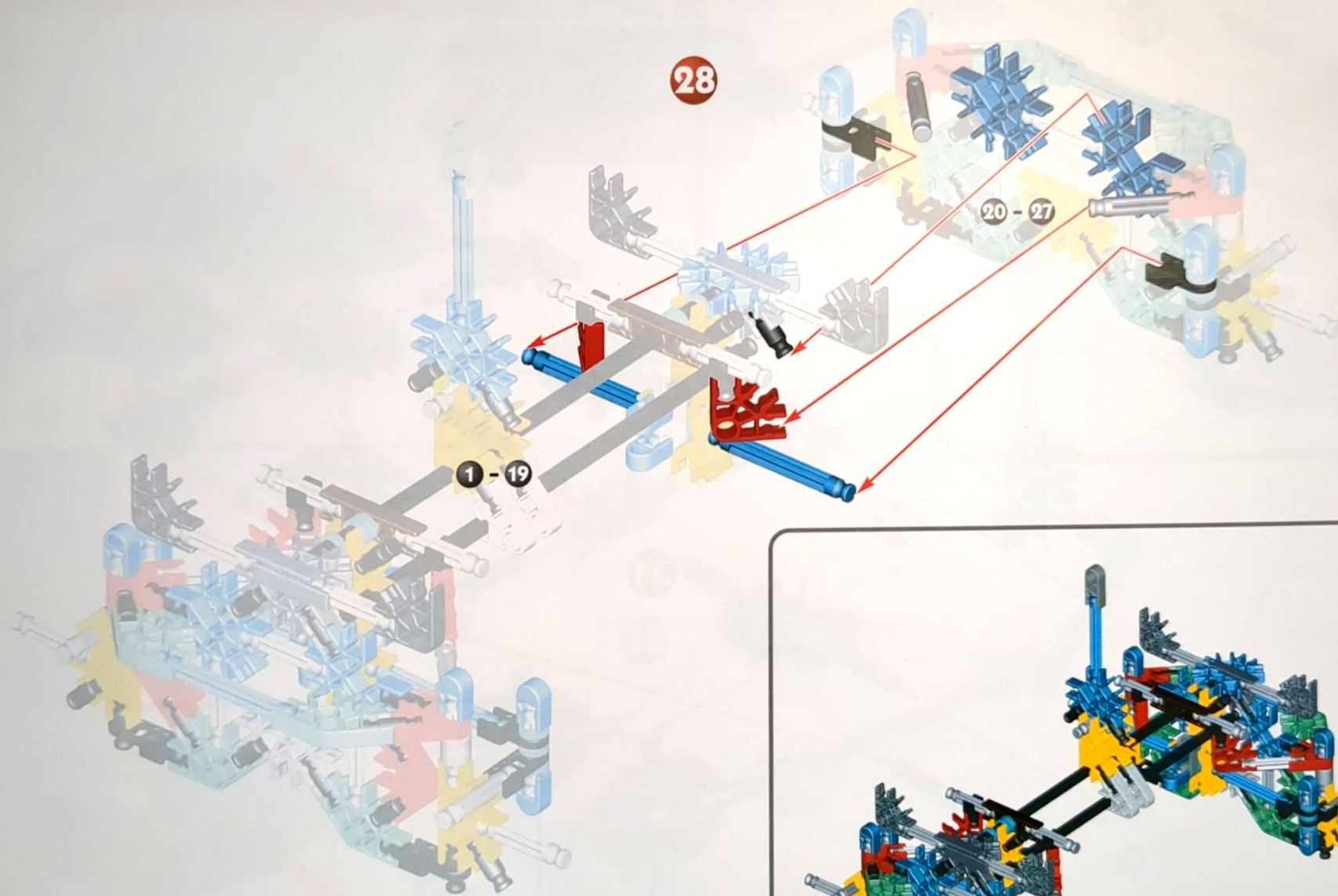

...and let's snap it on!

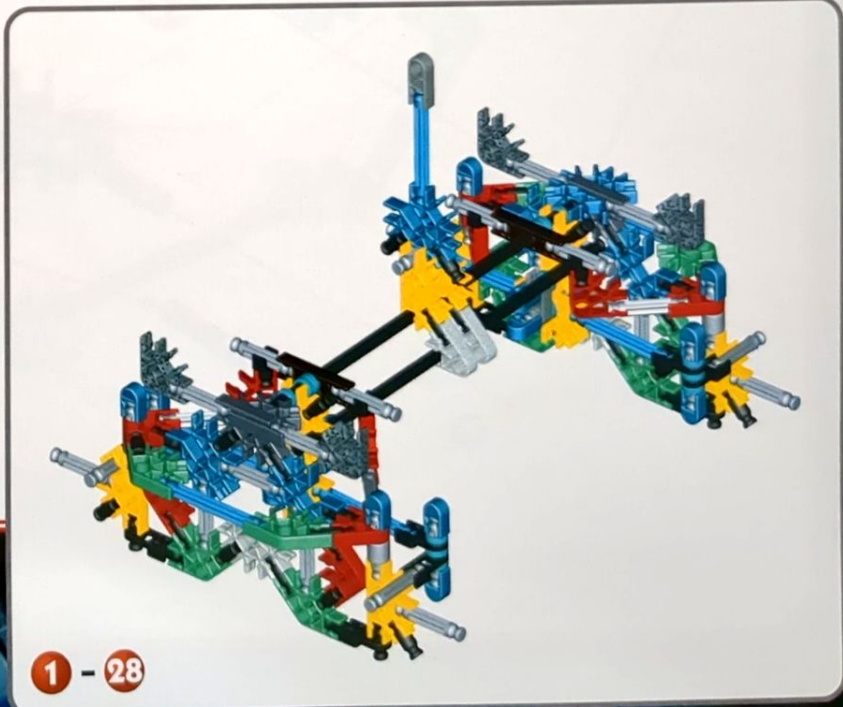

Now comes the fun part.... let's build the truck body!



29

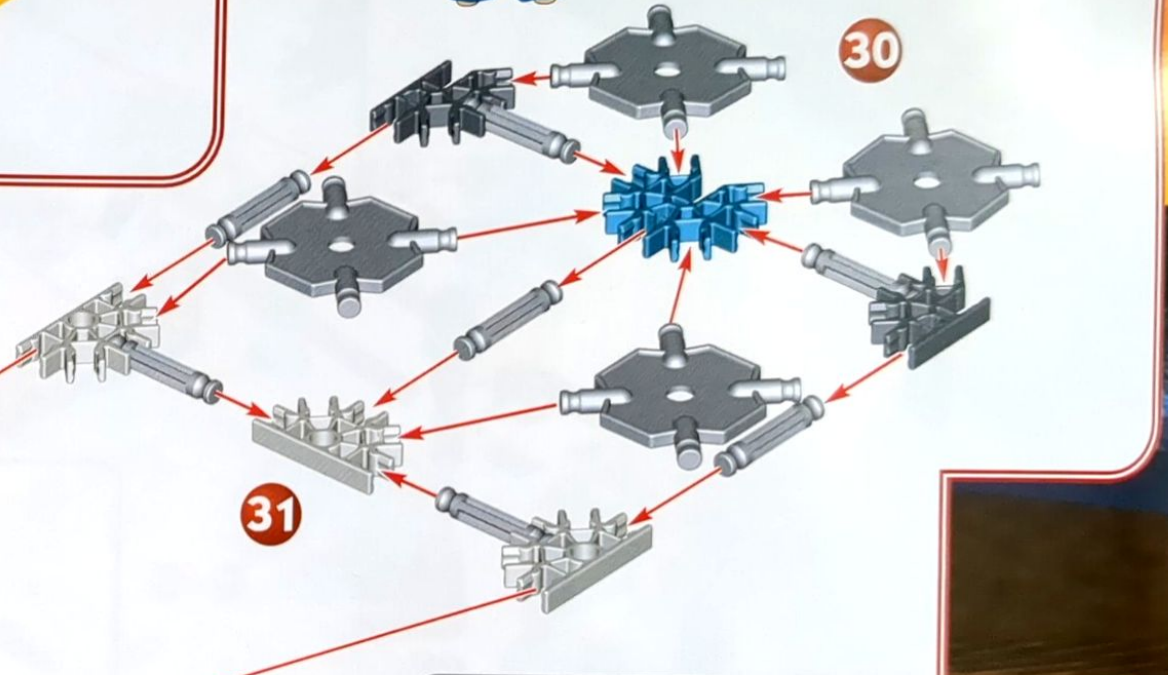

30

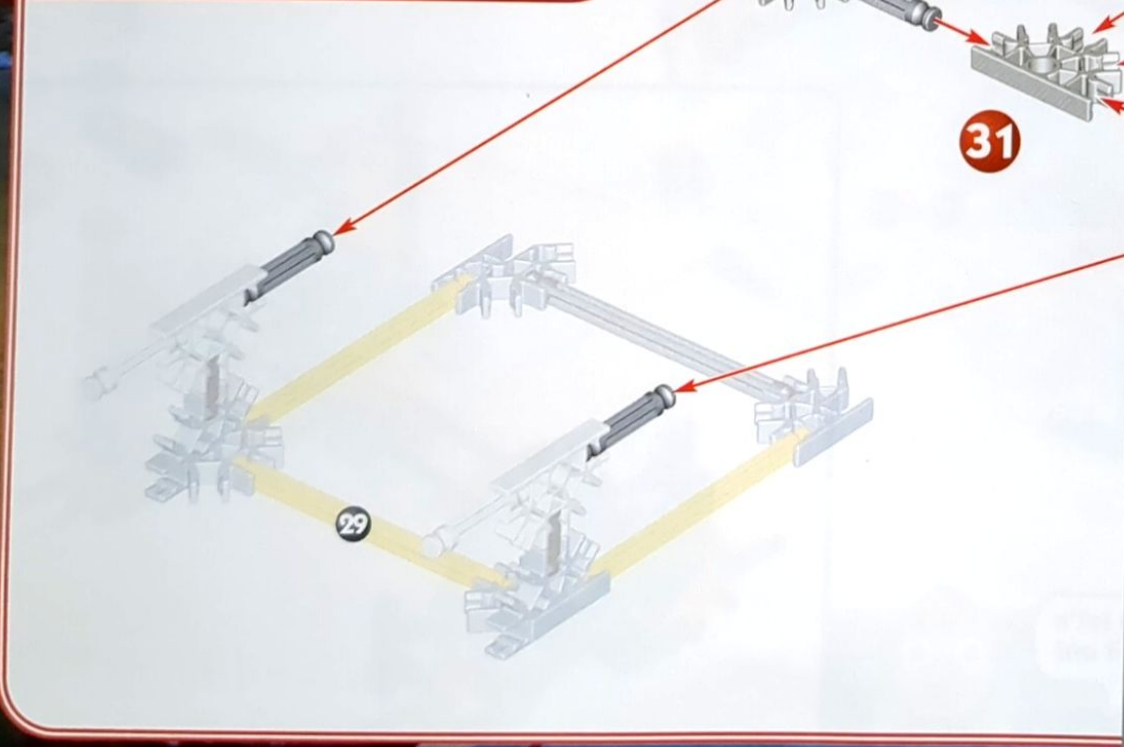

31

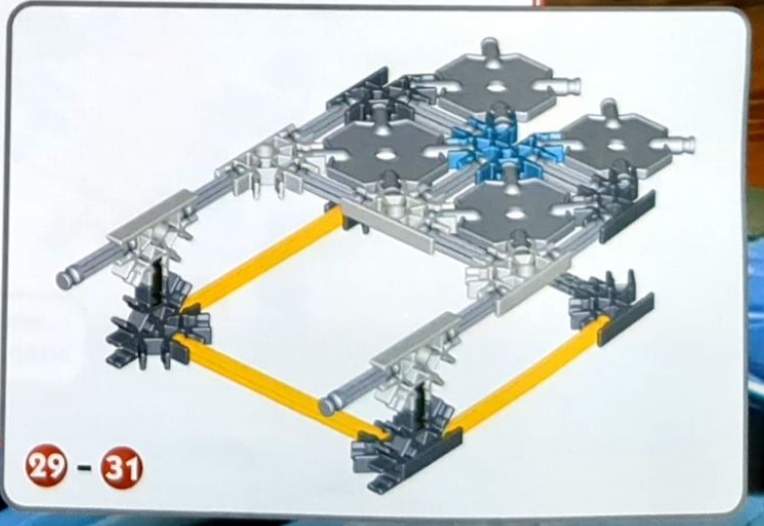

29 - 31

29 - 36

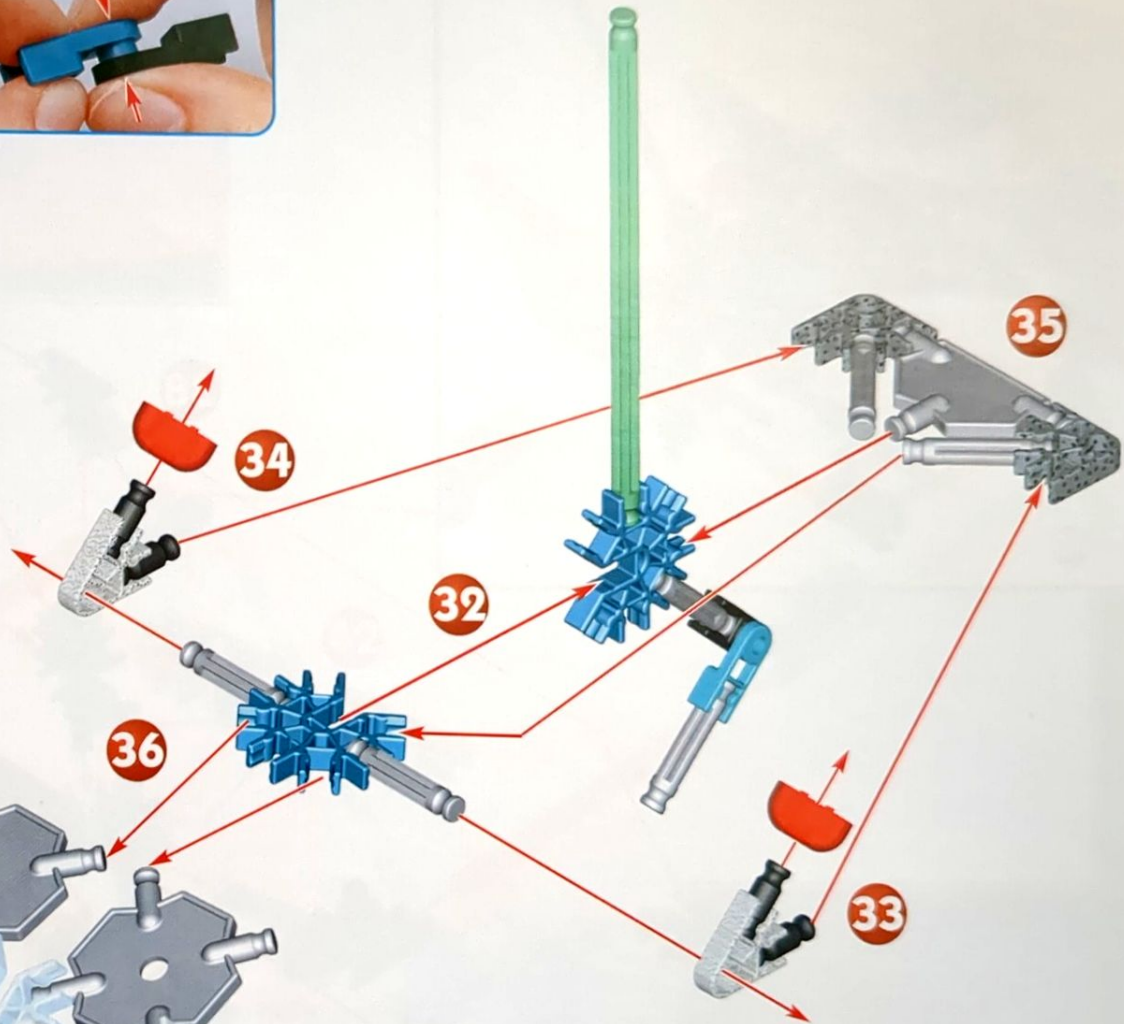

29 - 31

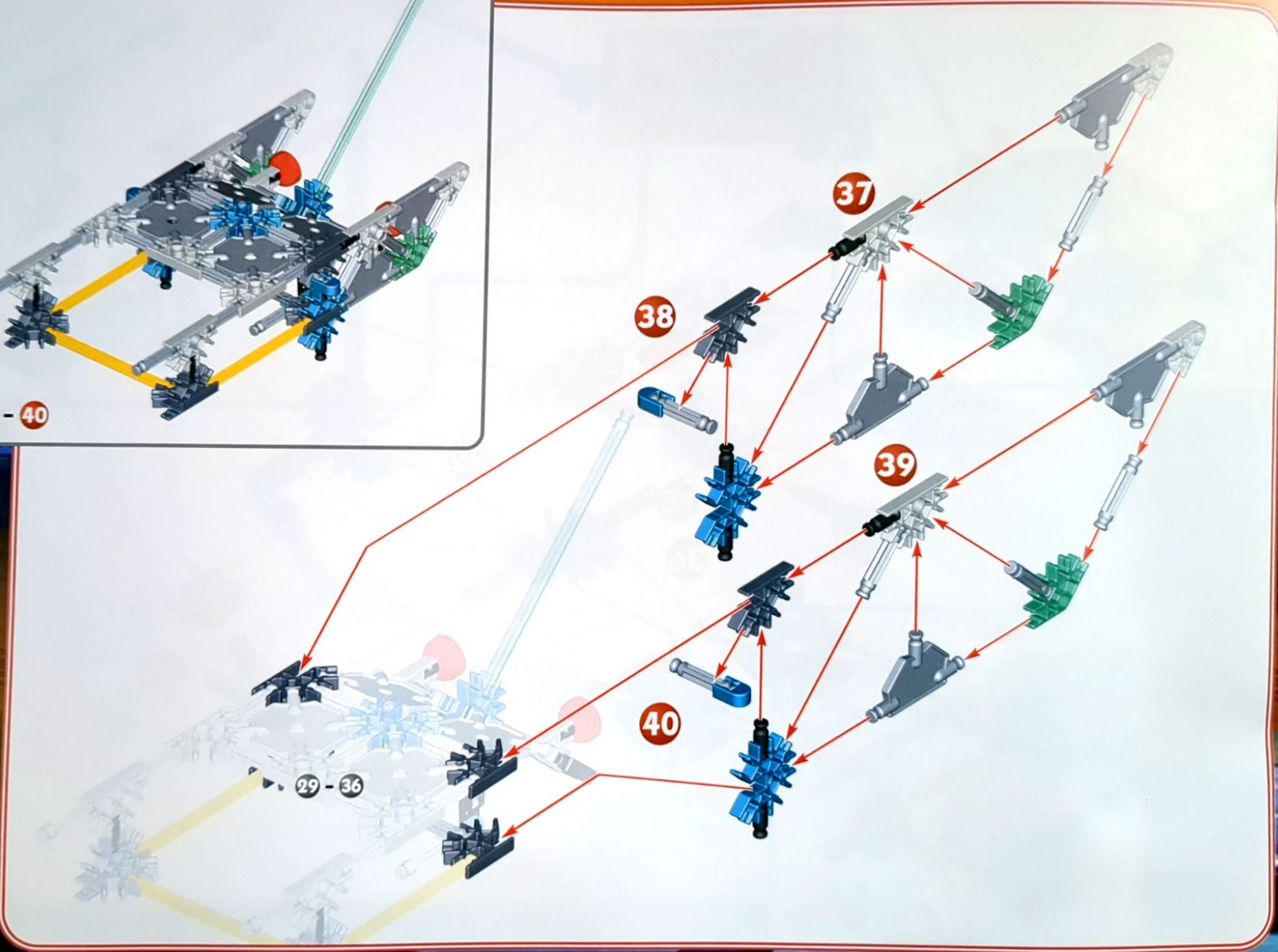

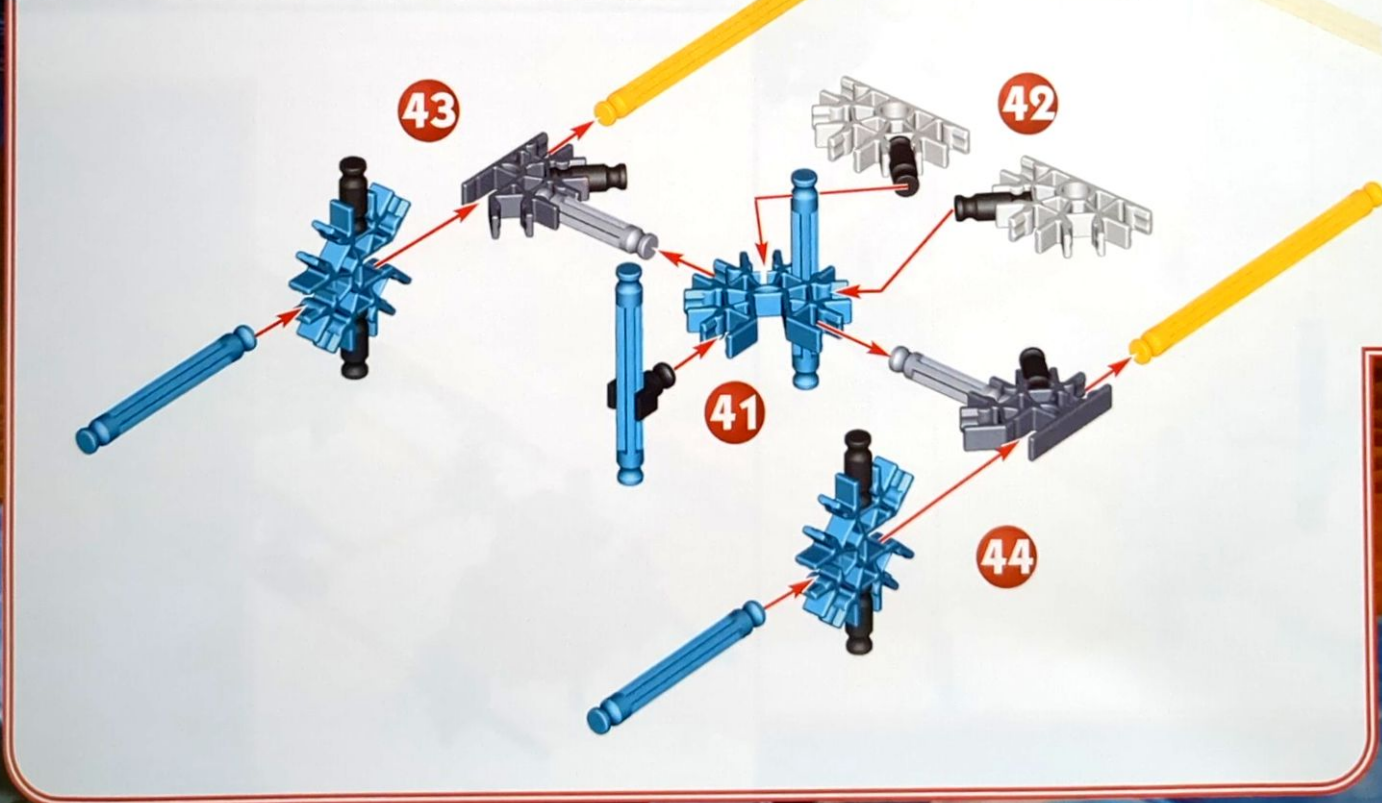
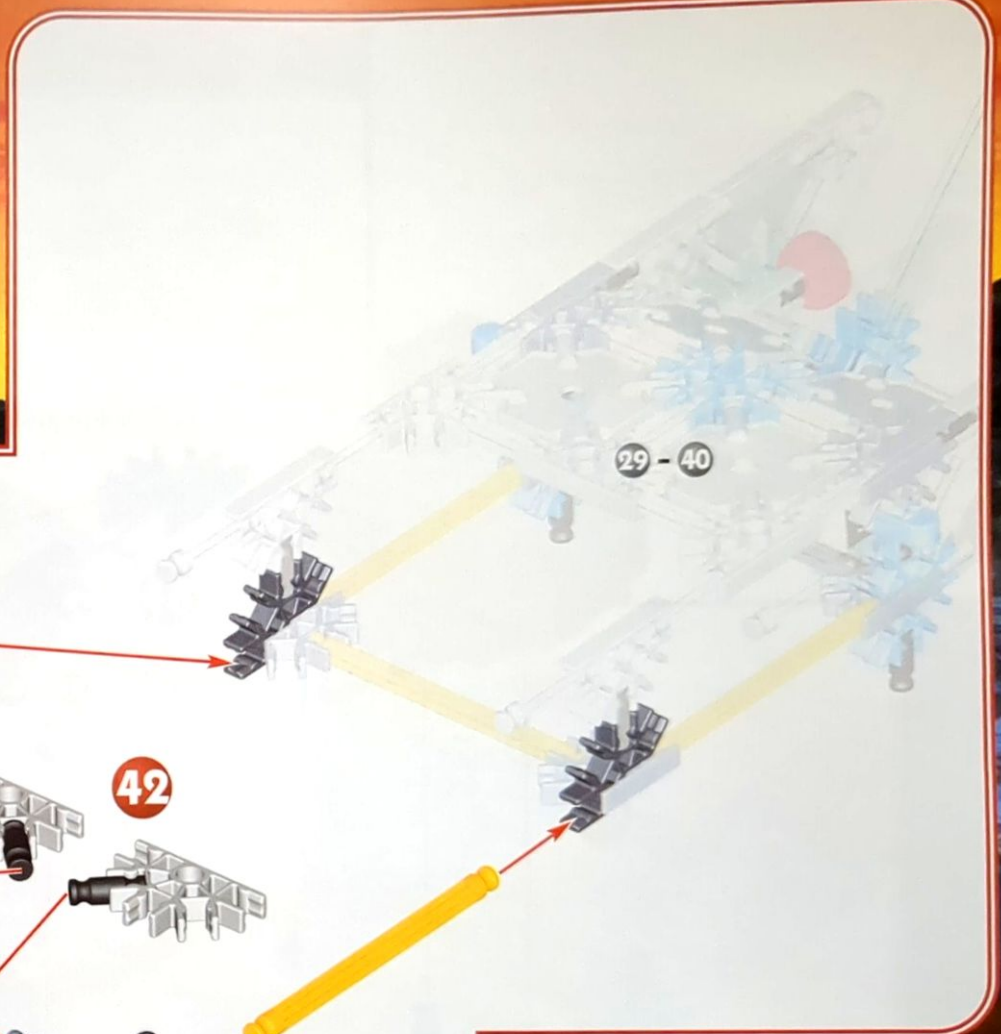



45

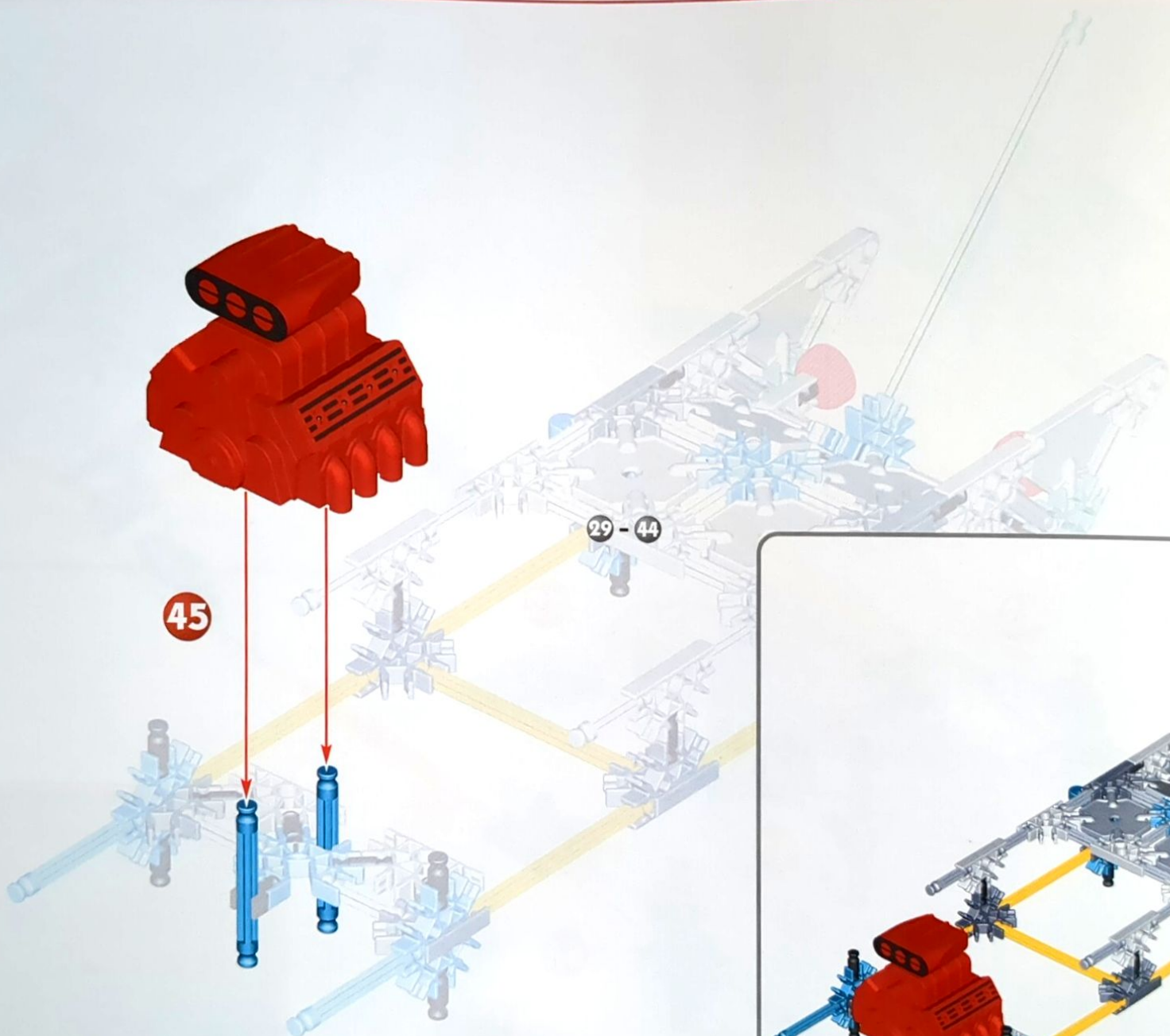

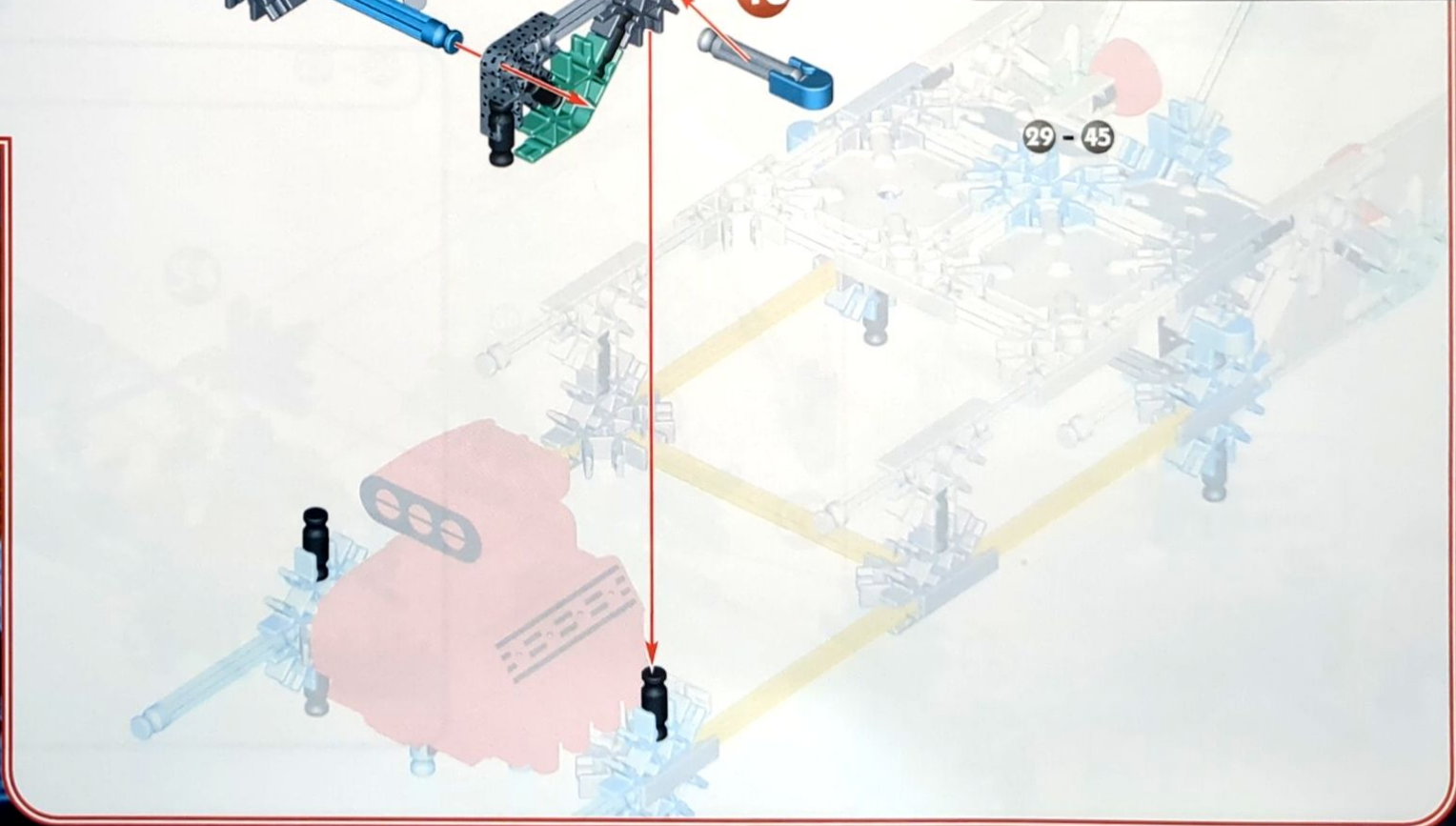
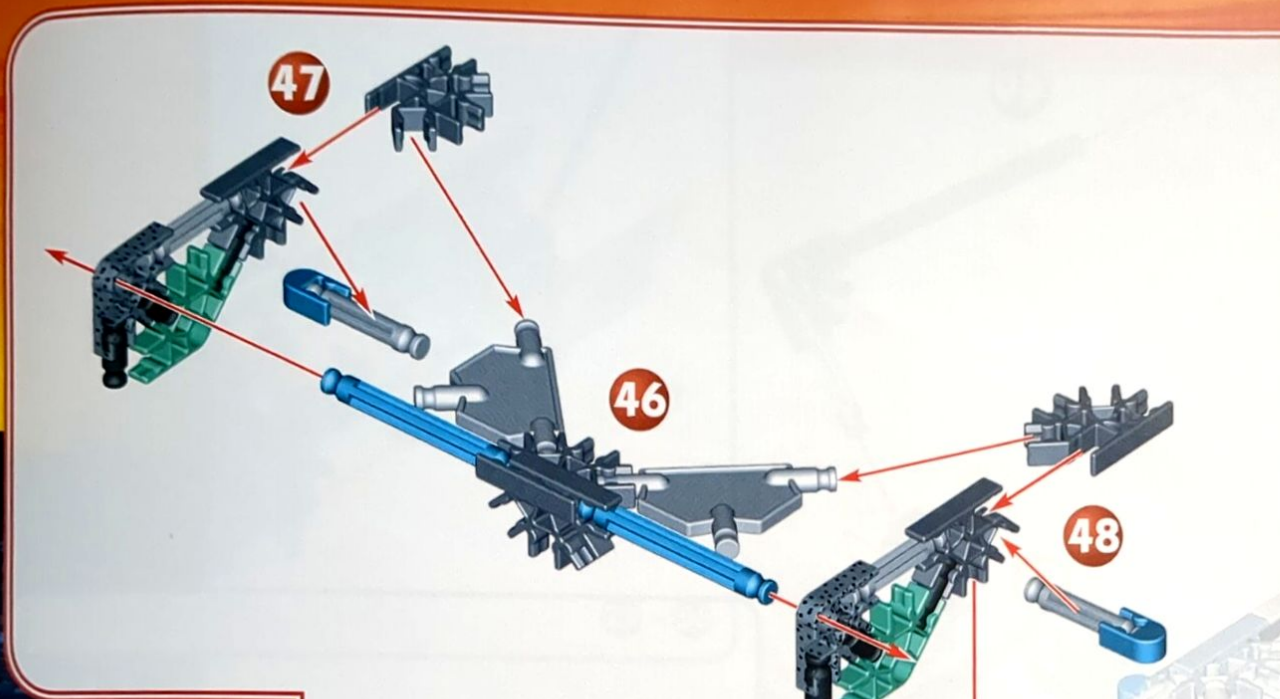

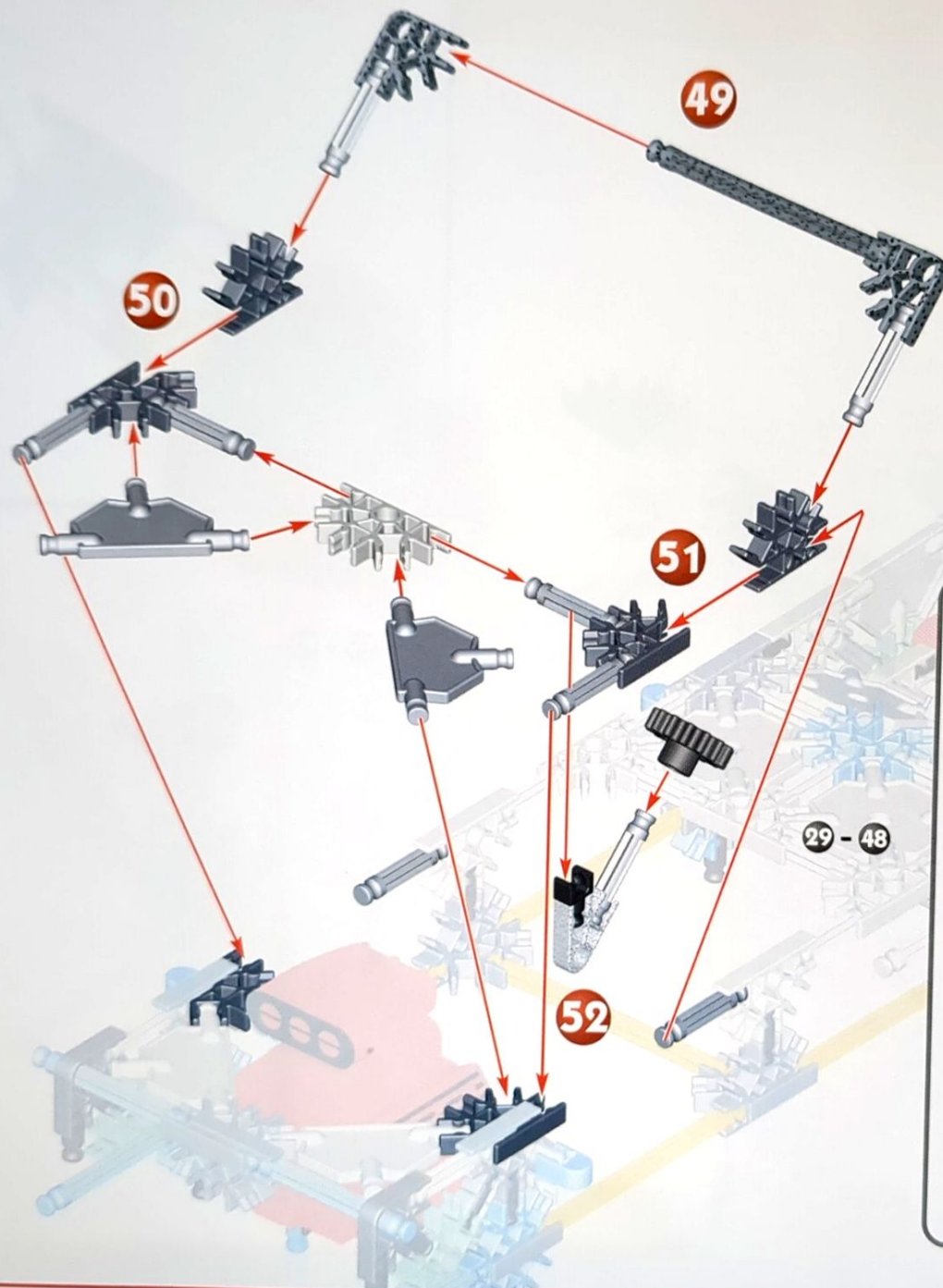

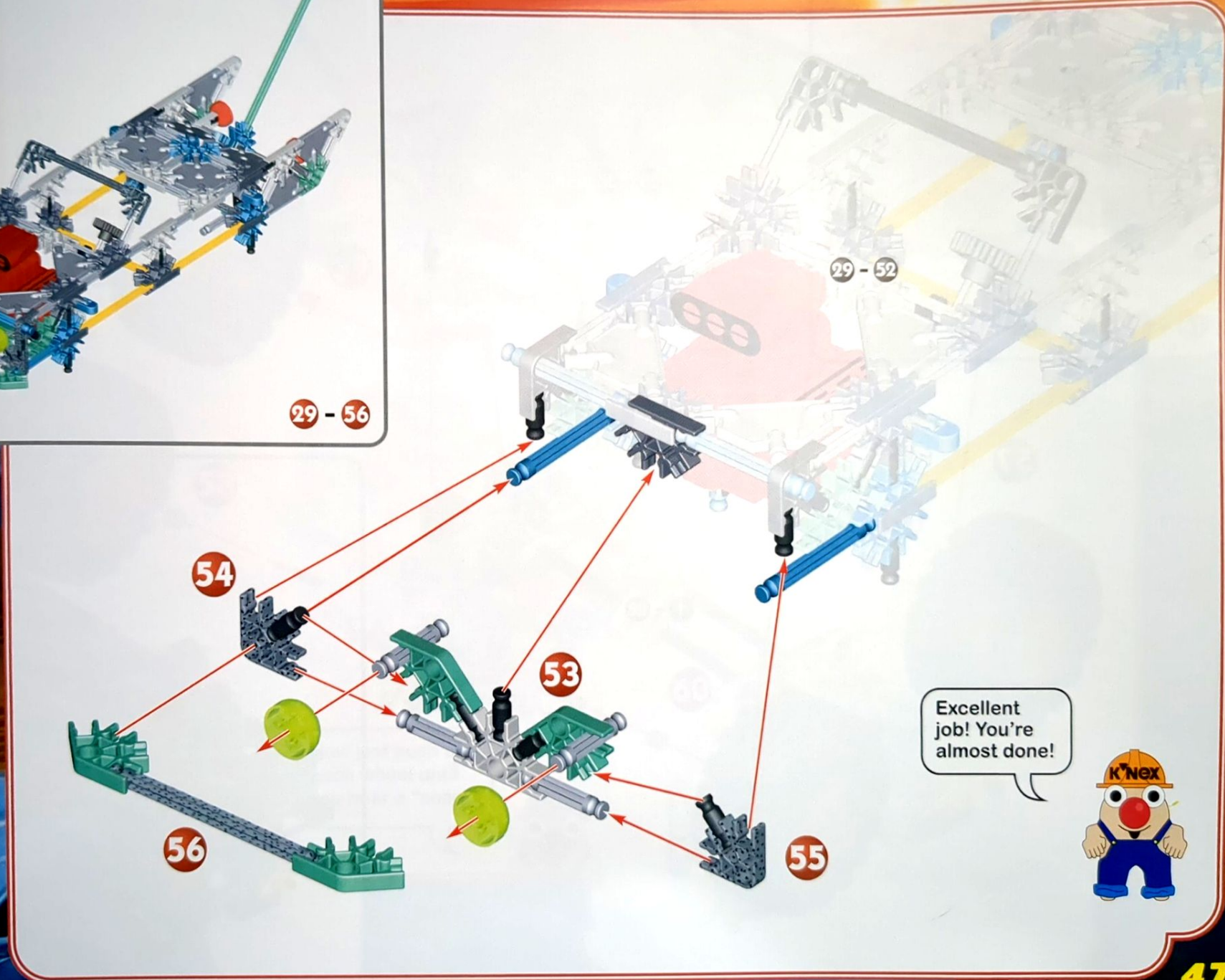

Excellent job! You're almost done!



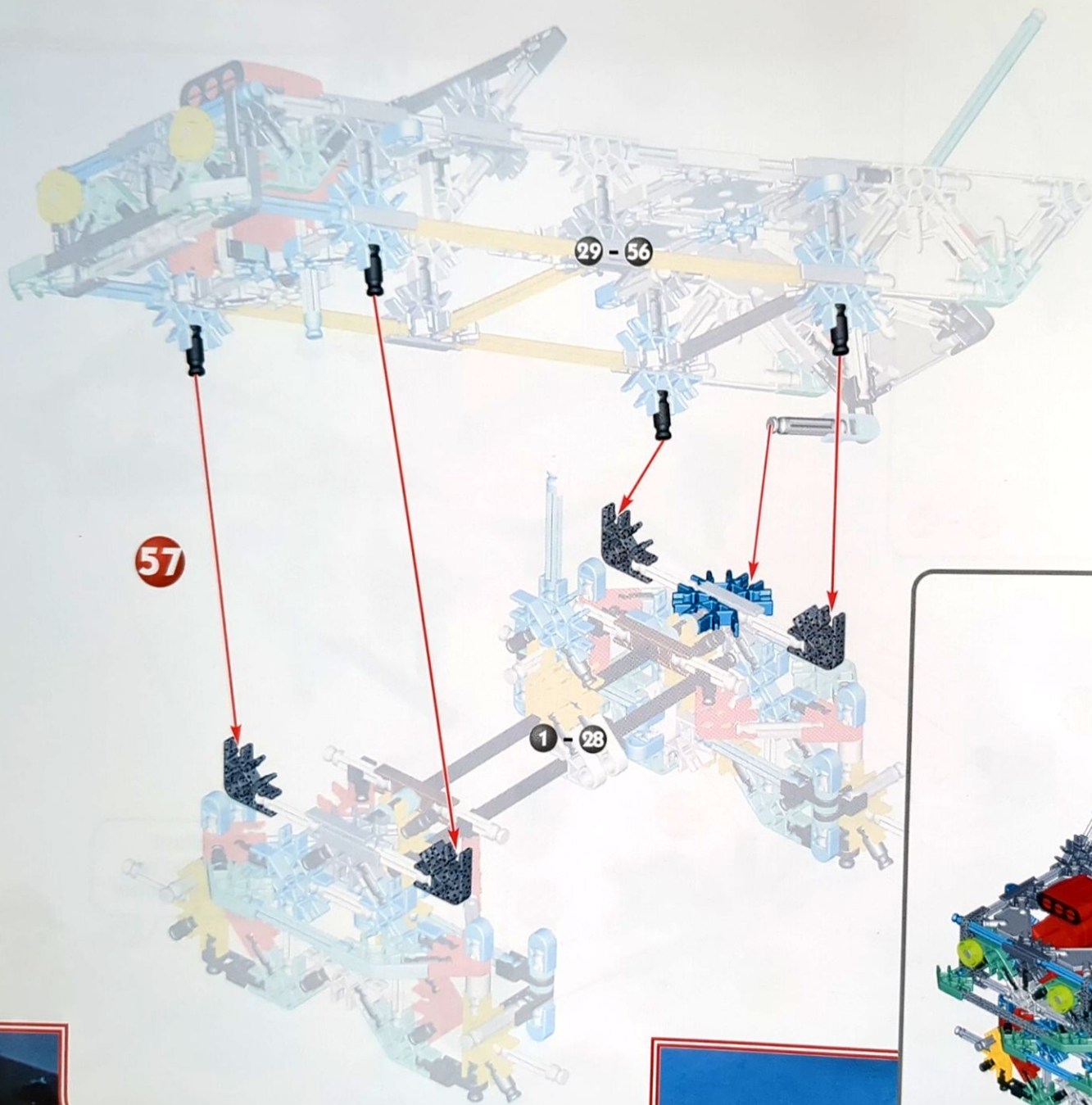

Here's where you connect the chassis to the body.



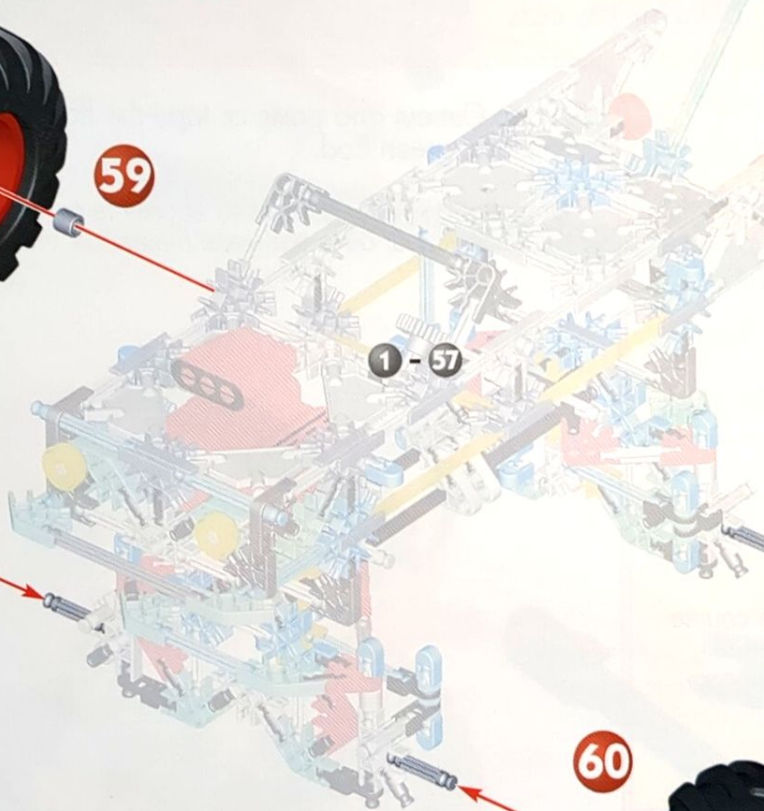
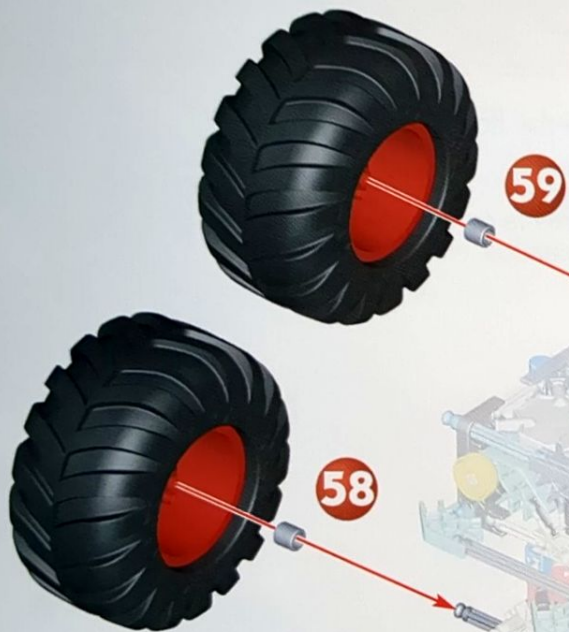

Now just push on each wheel until you hear a "snap"!



Cool Ways to play!

- Use your other toys to create an obstacle course and push your model through! And if you have other K'NEX sets, you can use the pieces to build simple cars and then push your Monster Truck over them for car crushin' excitement!
- Trace the shape of the racing graphic panels onto white paper. Then try designing your own graphic panels and put them on your model for a personalized look!
- Utilise tes autres jouets pour créer un parcours d'obstacles et force ton modèle à franchir ces obstacles. Et si tu as d'autres jeux K'NEX, tu peux te servir des pièces pour construire des voitures. Fais passer ton camion Monster Truck par-dessus celles-ci pour créer une excitation inouïe de voitures écrasées!
- Trace la forme des panneaux à graphiques de course sur du papier blanc. Puis, essaie de concevoir tes propres panneaux et attache-les à ton modèle pour créer un aspect personnalisé!

- Flag: Cut out and paste or tape the flag around the metallic green Rod.
- Drapeau: Découpe le drapeau et colle-le ou attache-le avec du ruban autour de la tige verte métallique.

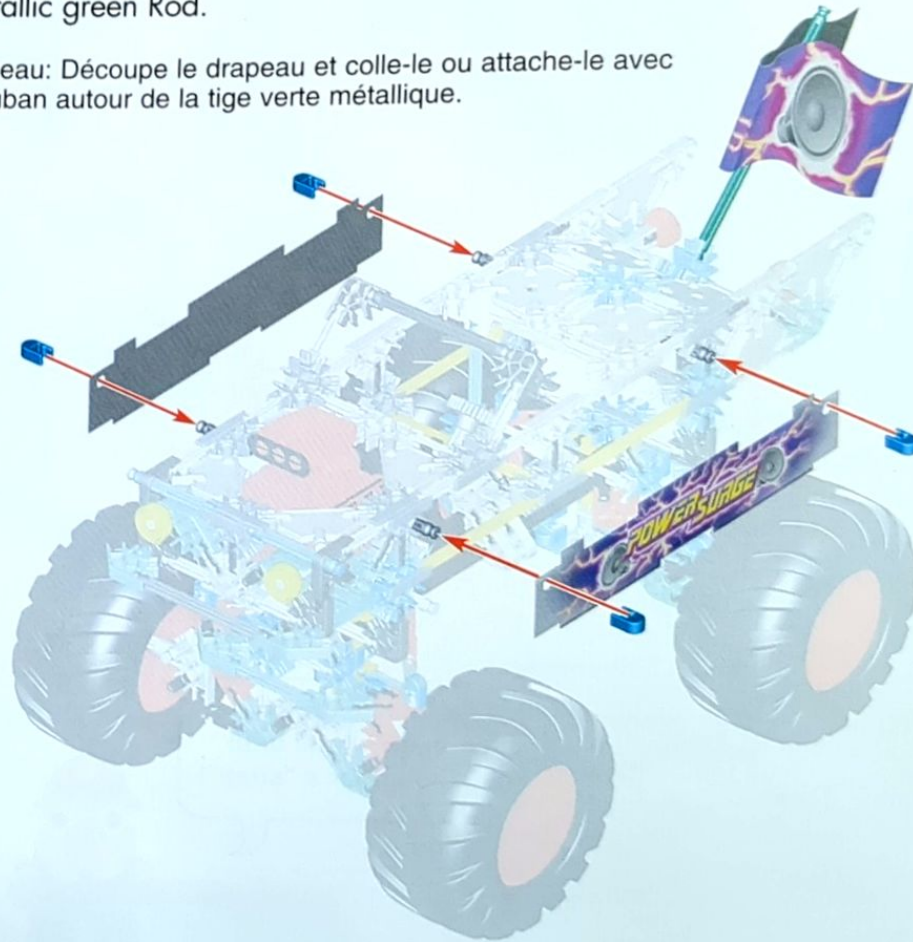

HIJACKER

- A Jacked-Up
Monster Truck!



Adult Help is
Recommended

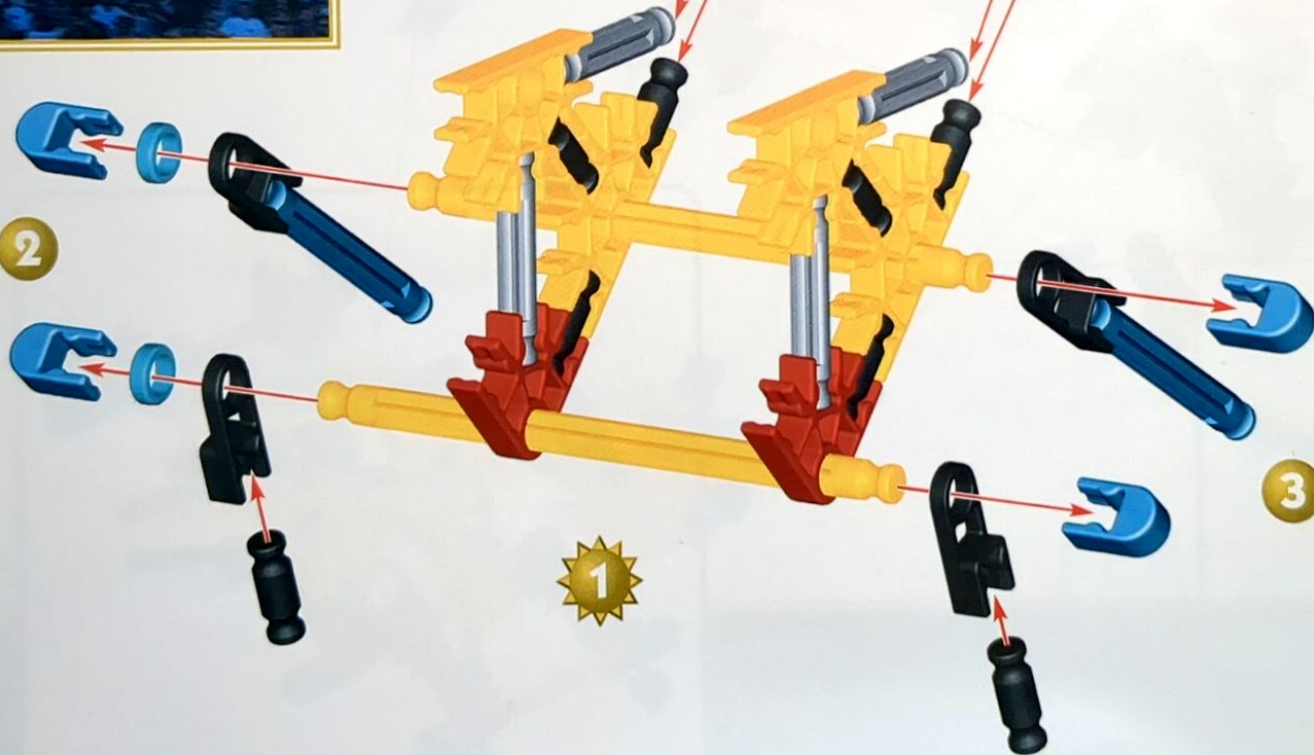
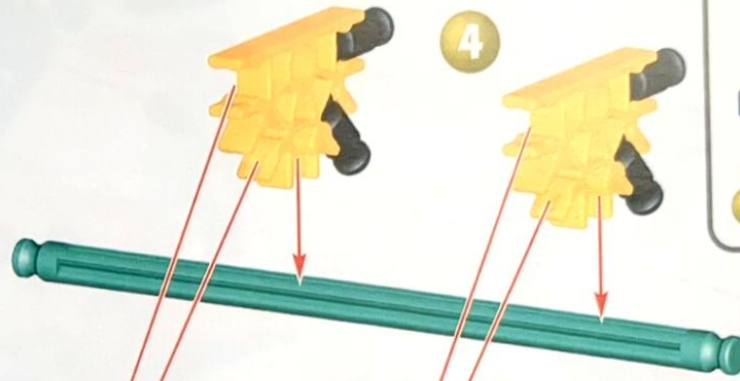

Hey kids,
let's build
Hijacker...
follow me!



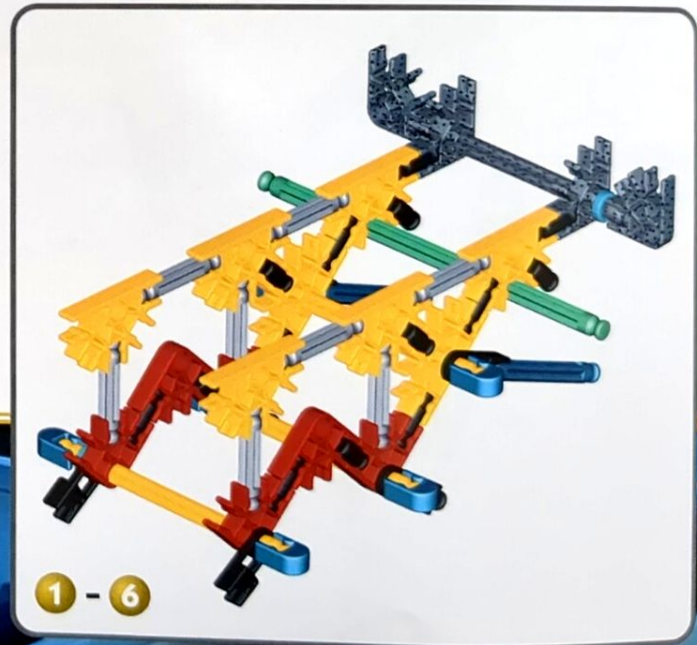
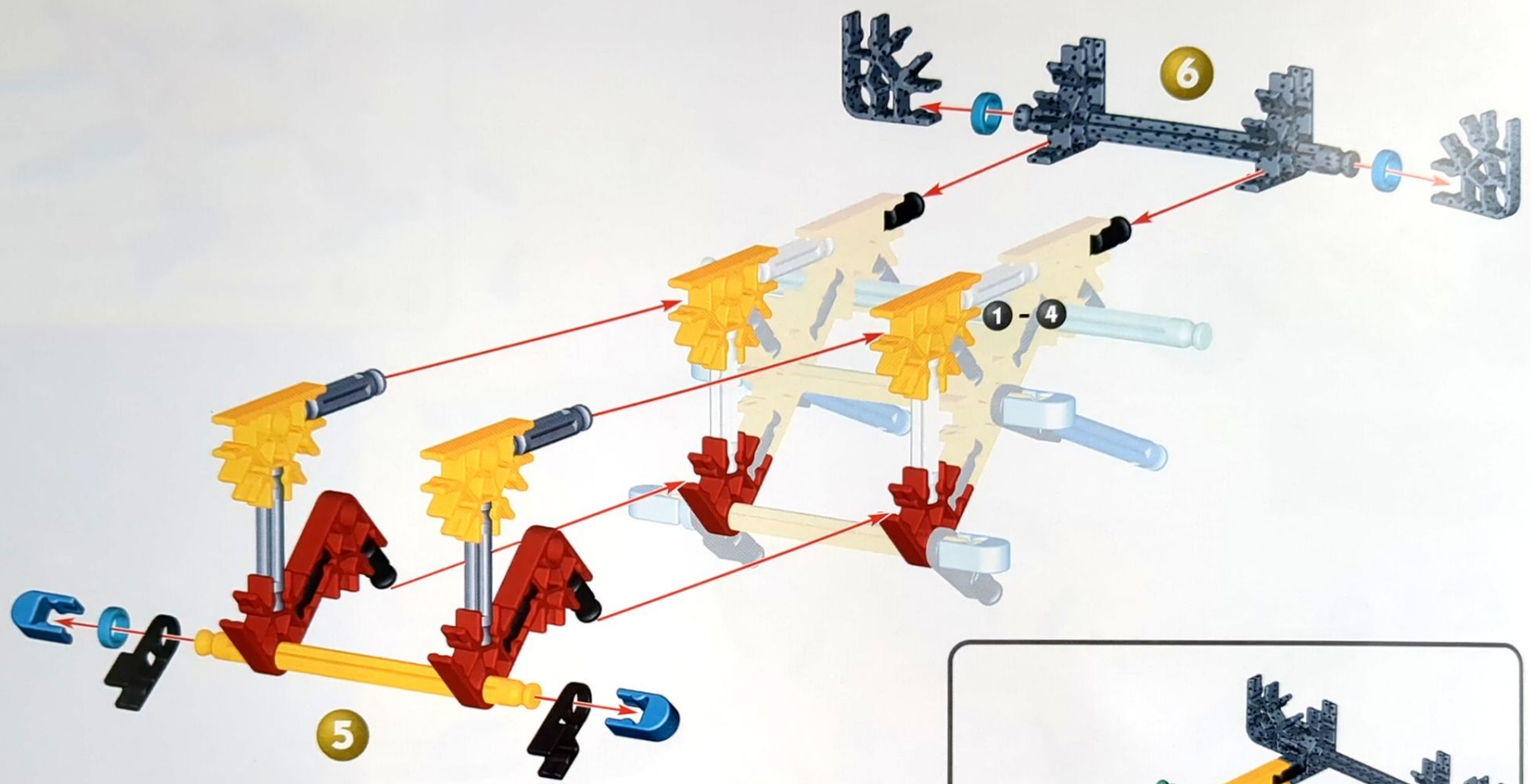

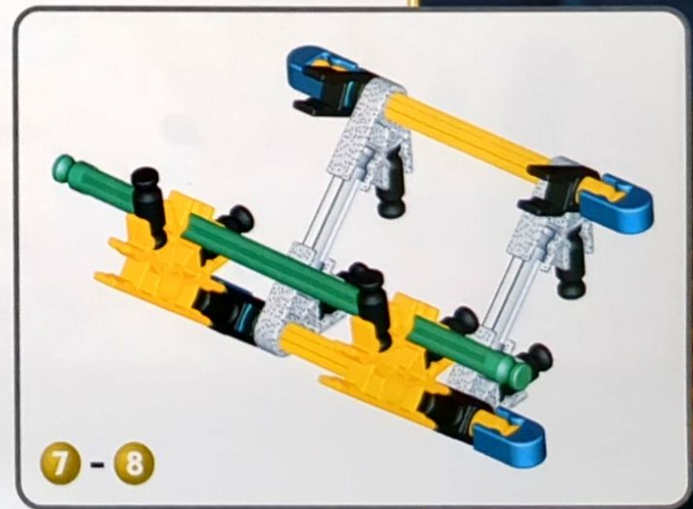
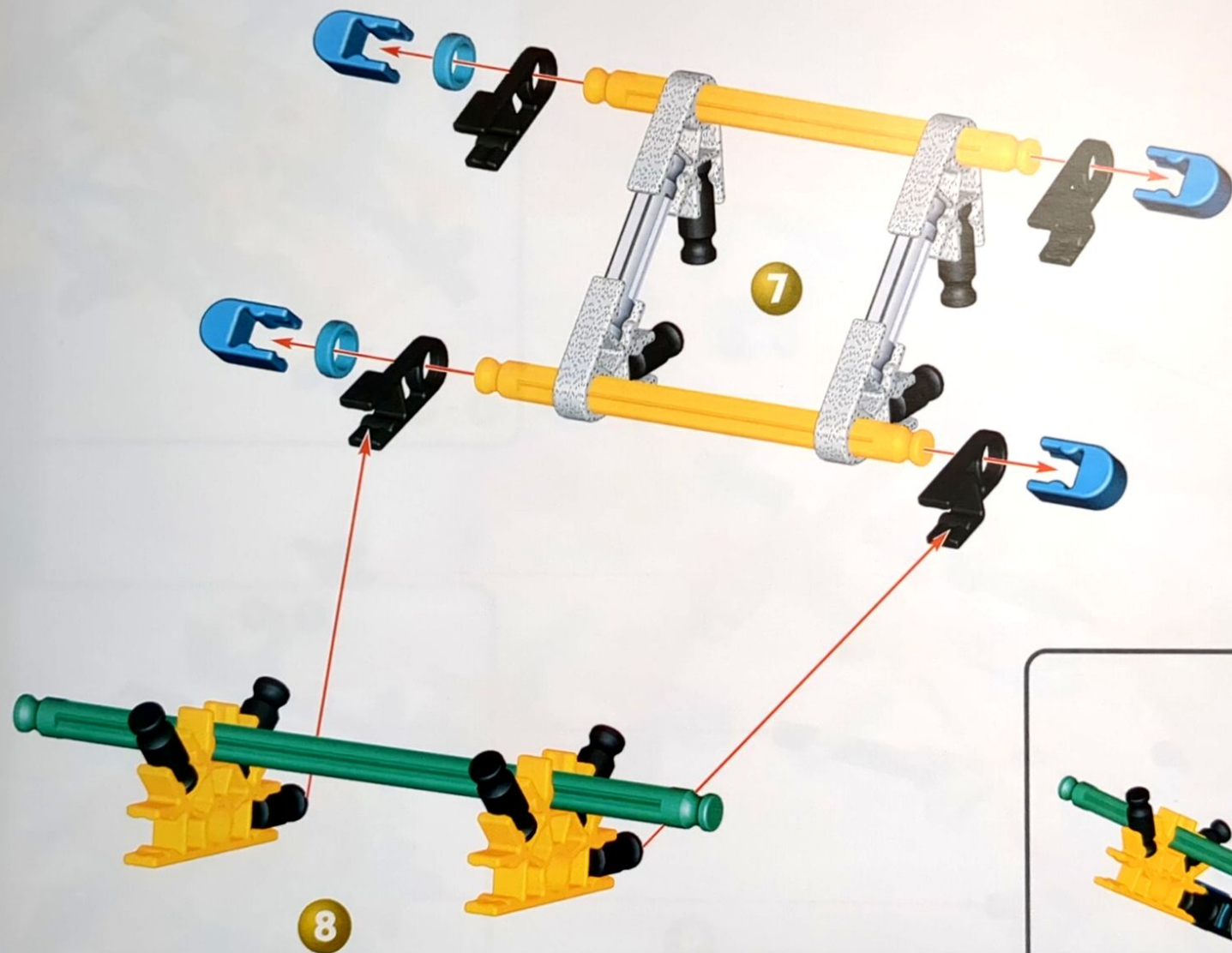

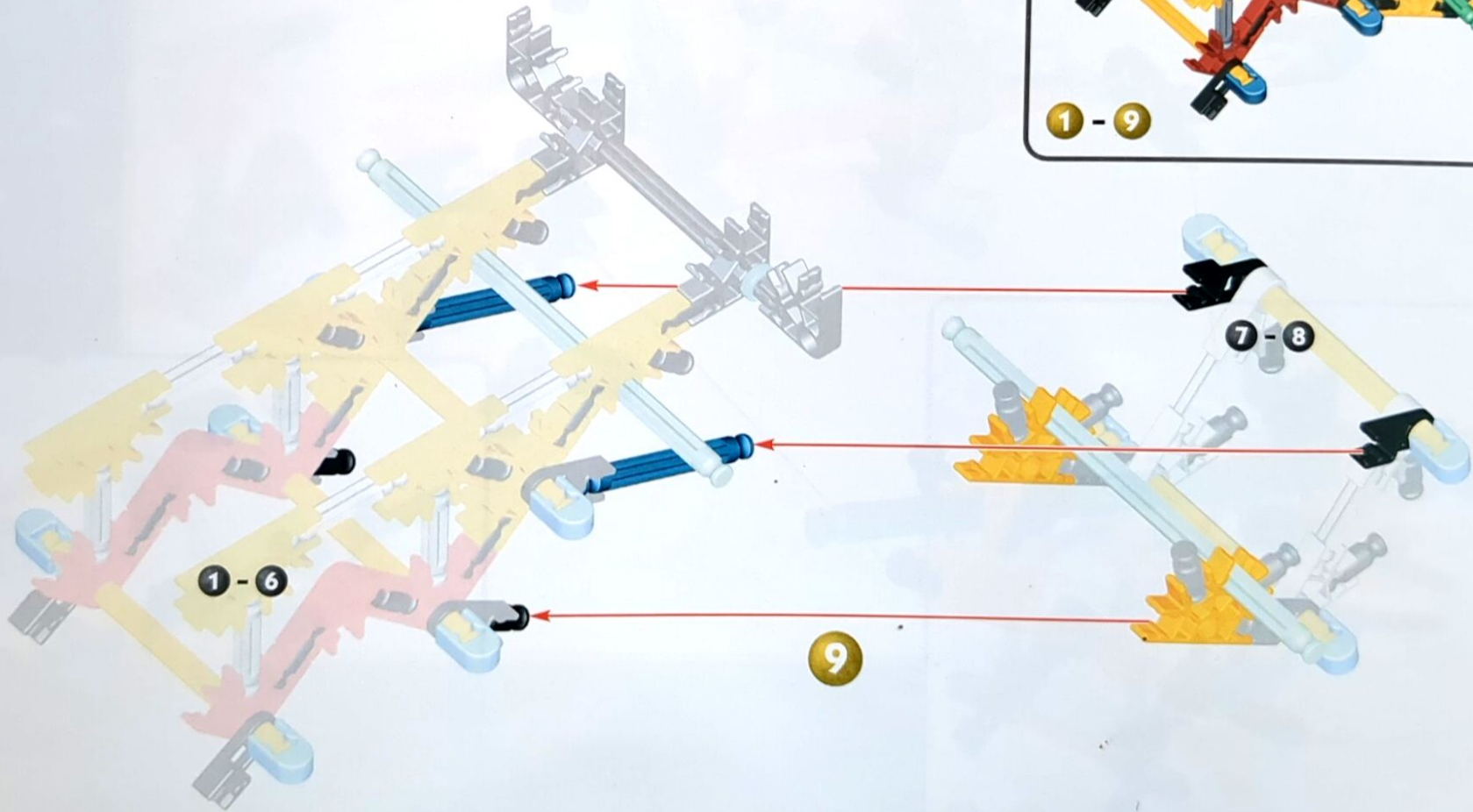

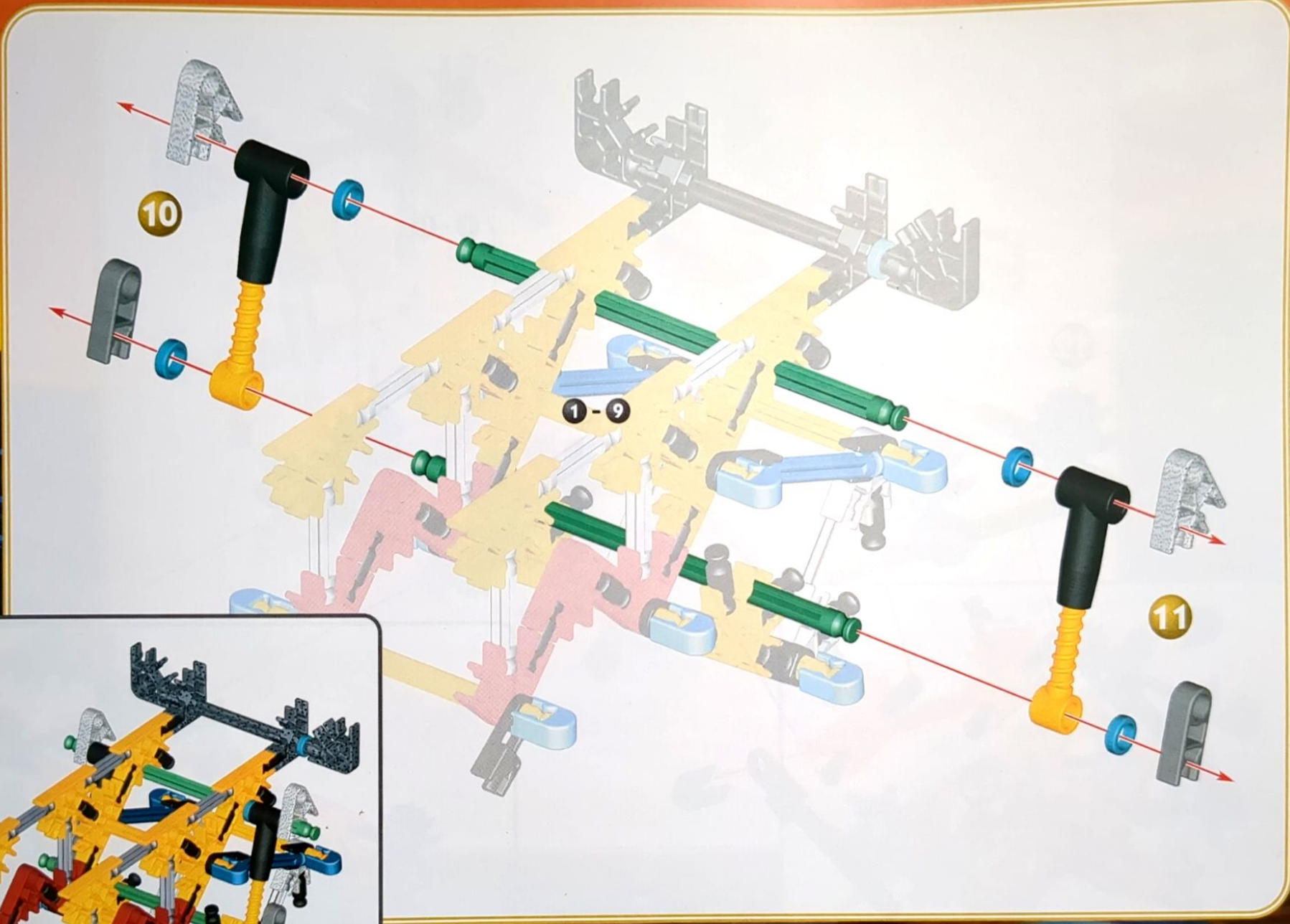

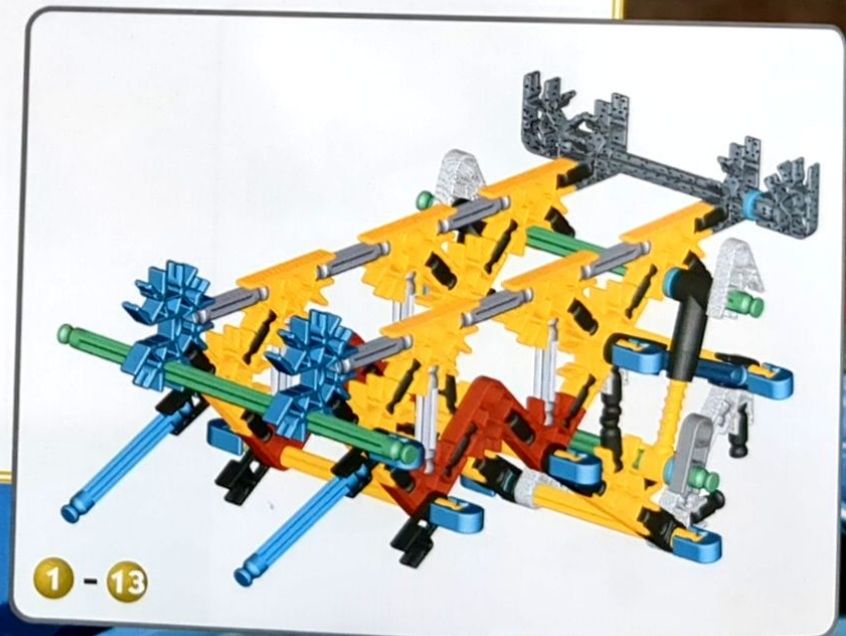
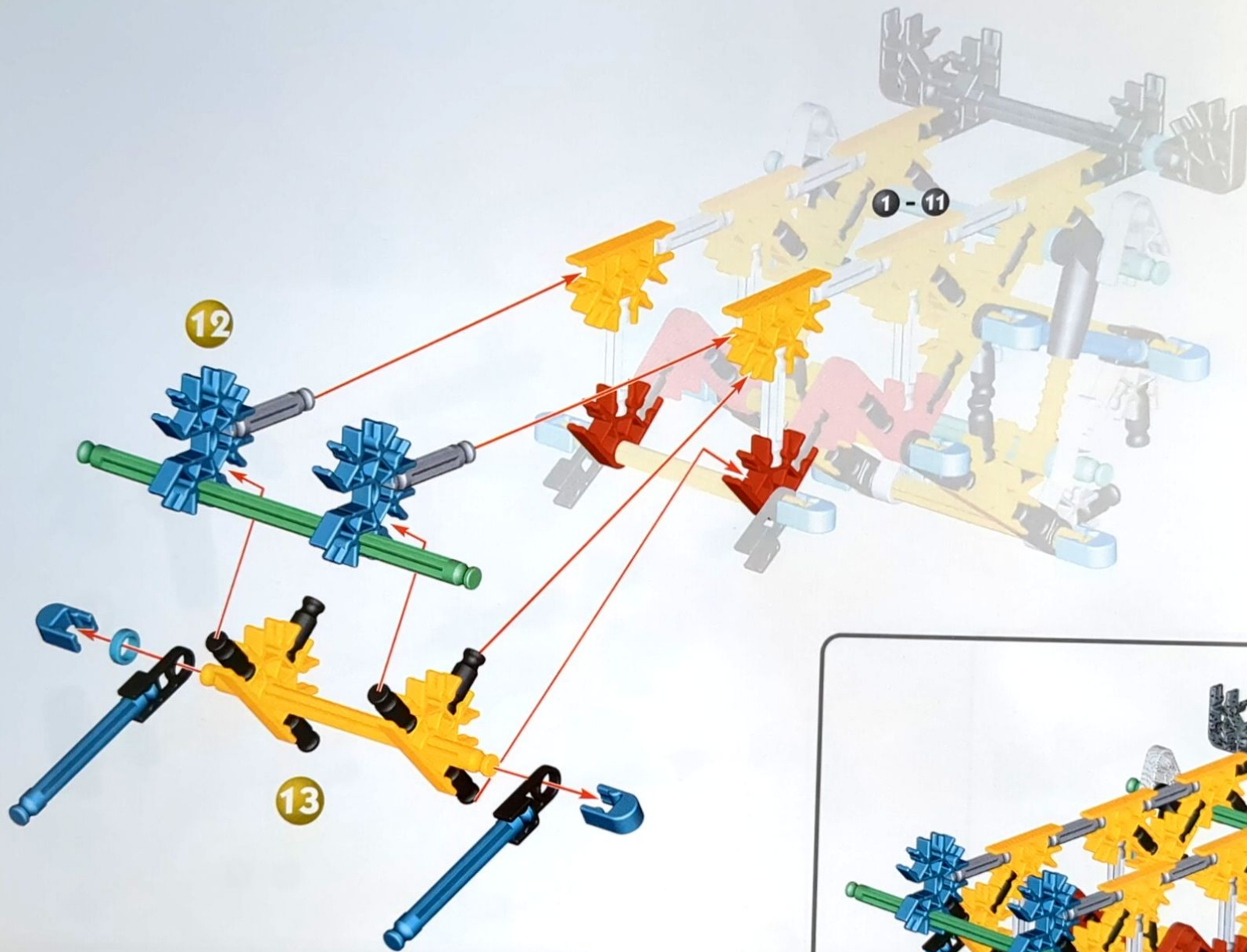

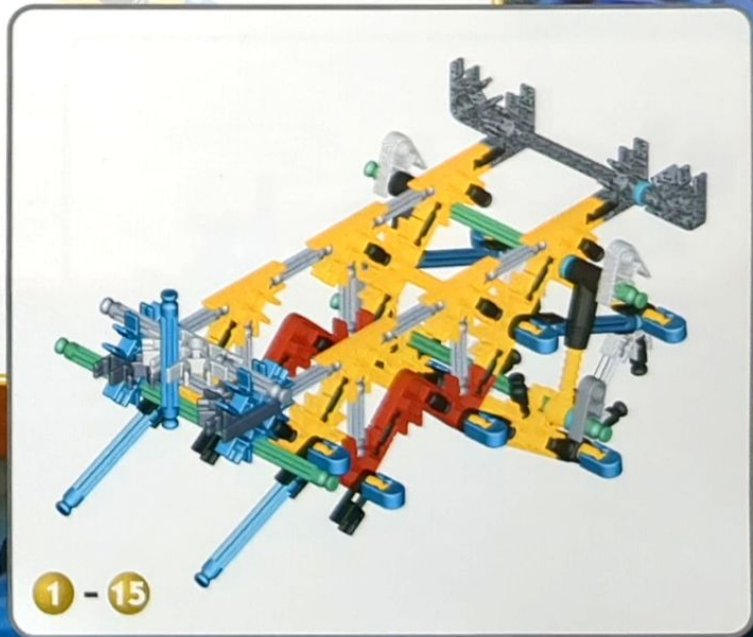
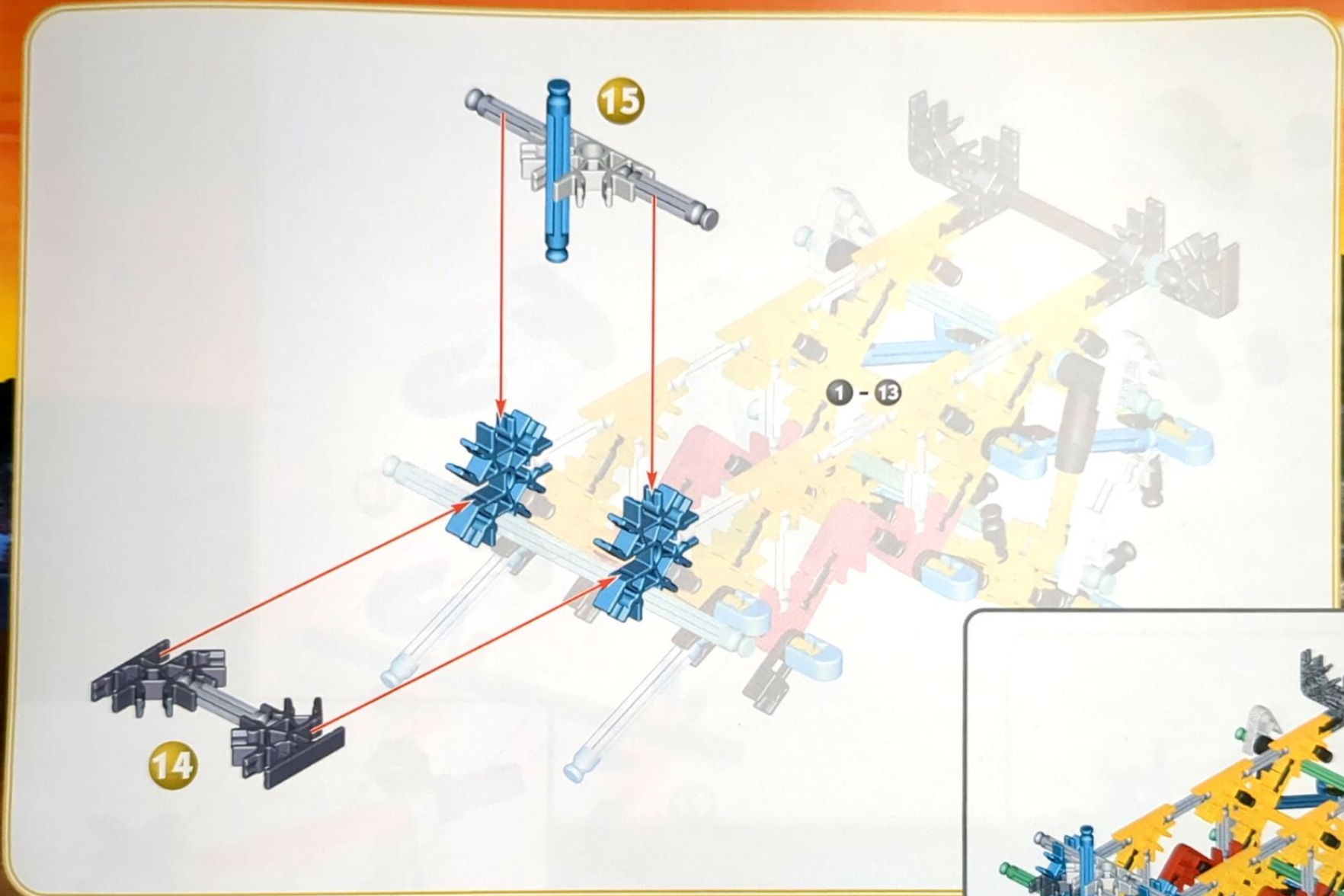

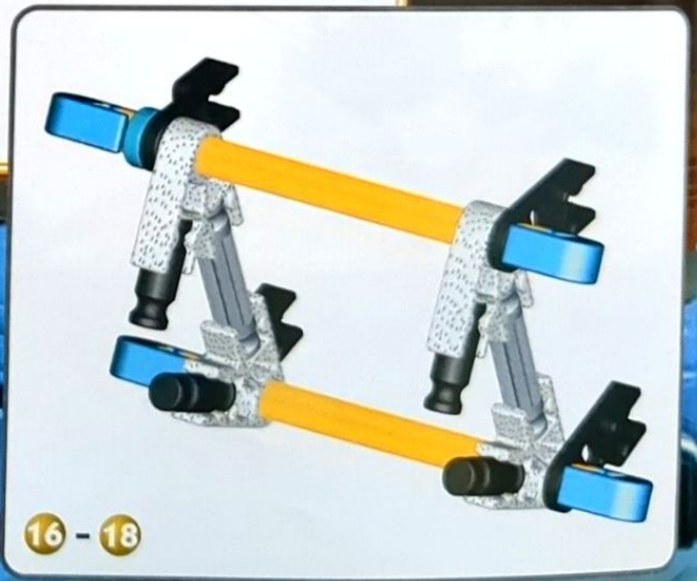
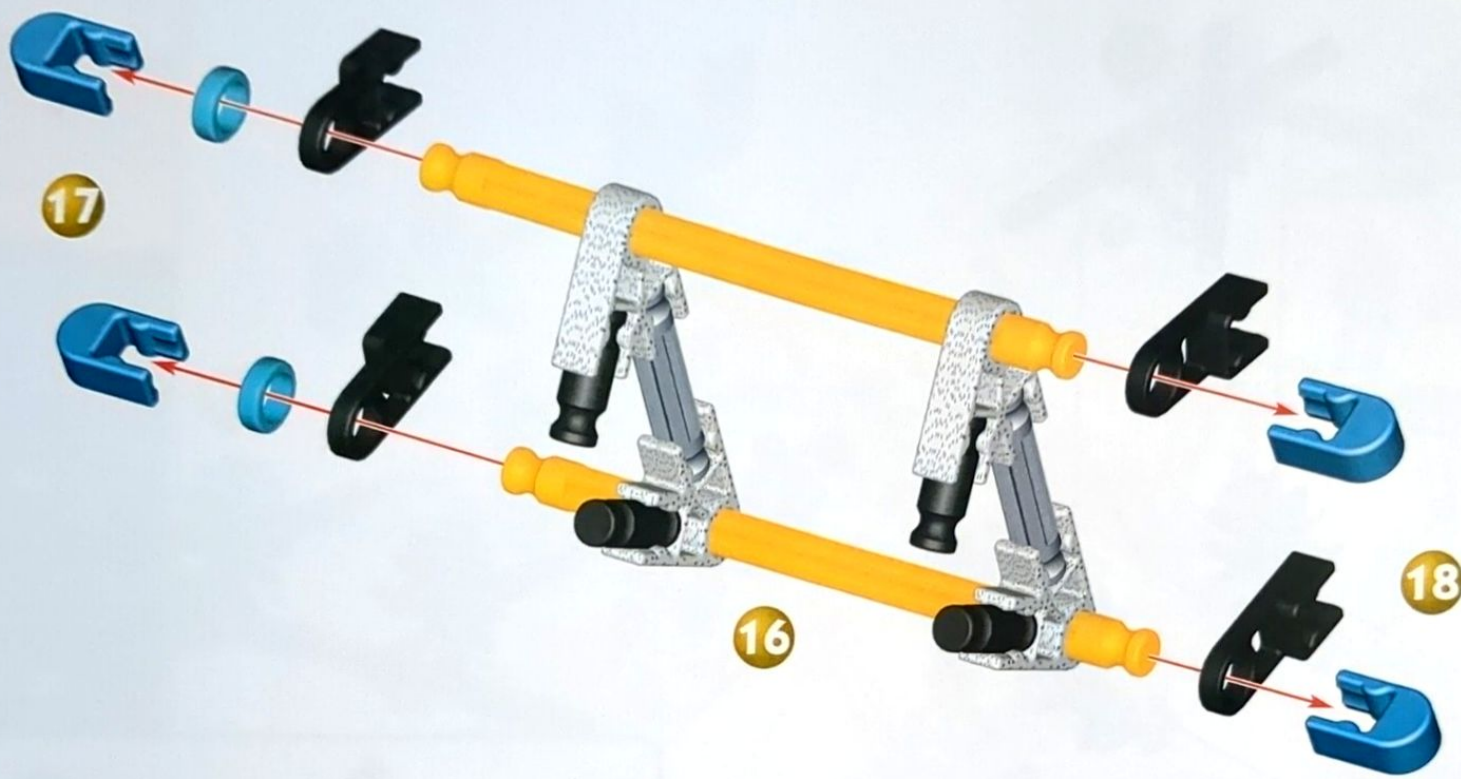

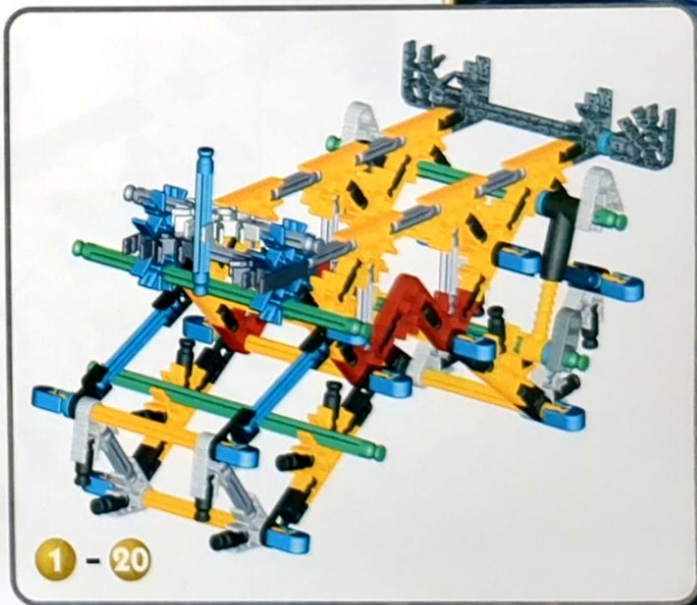
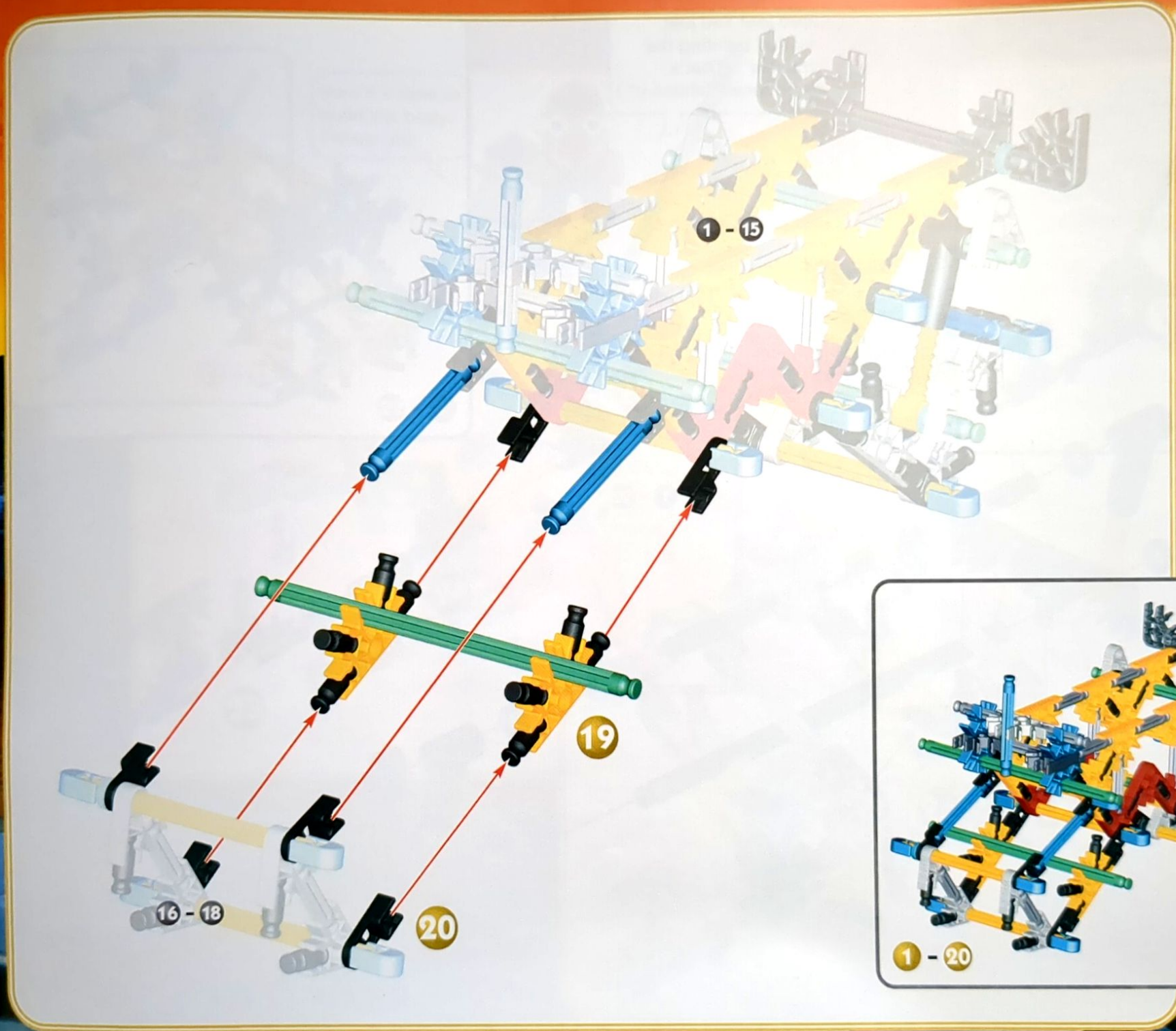

Good job! You just finished building the "chassis". (That's pronounced "chass-y".)

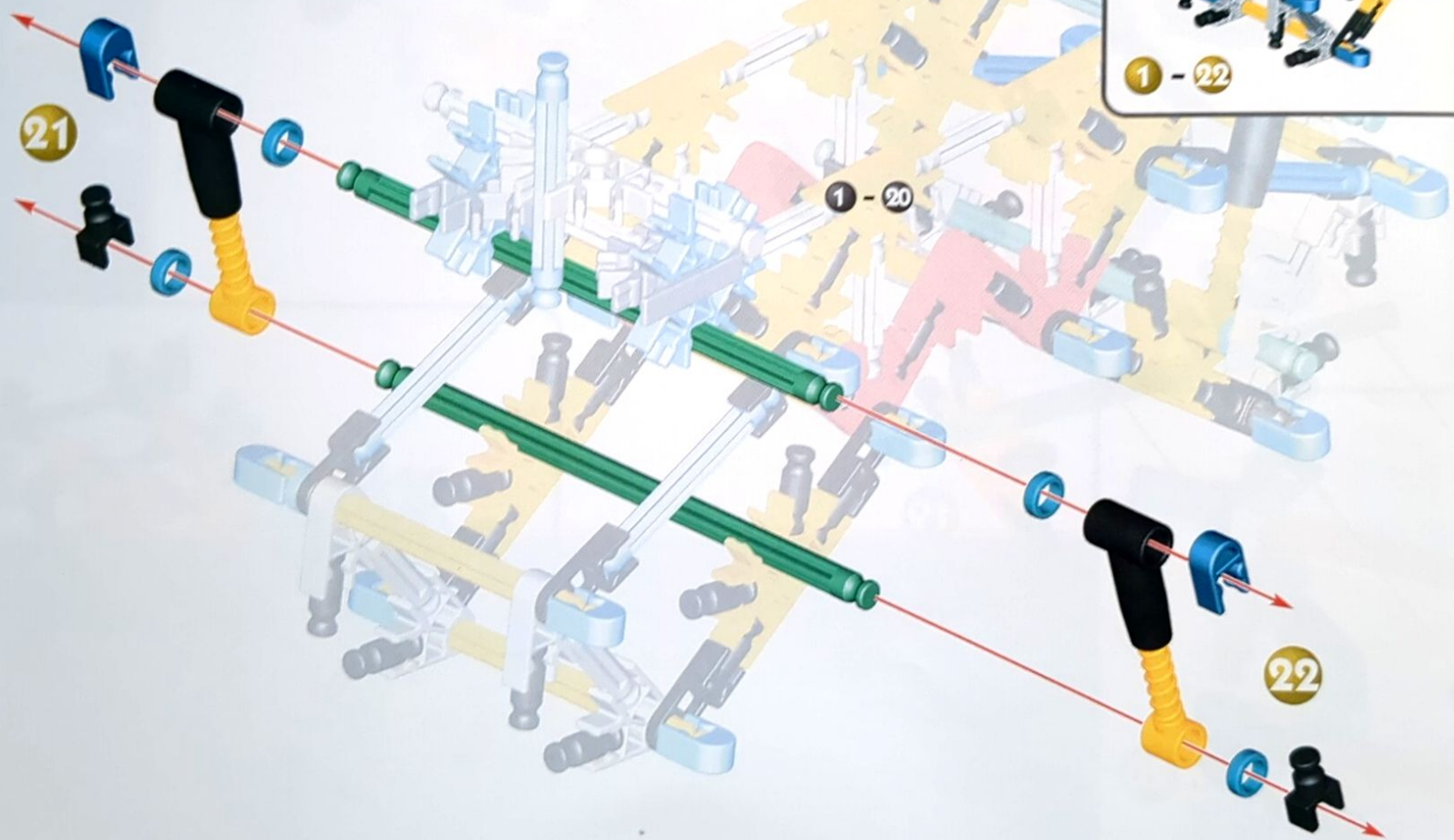

Now it's time to build the body. Follow me!

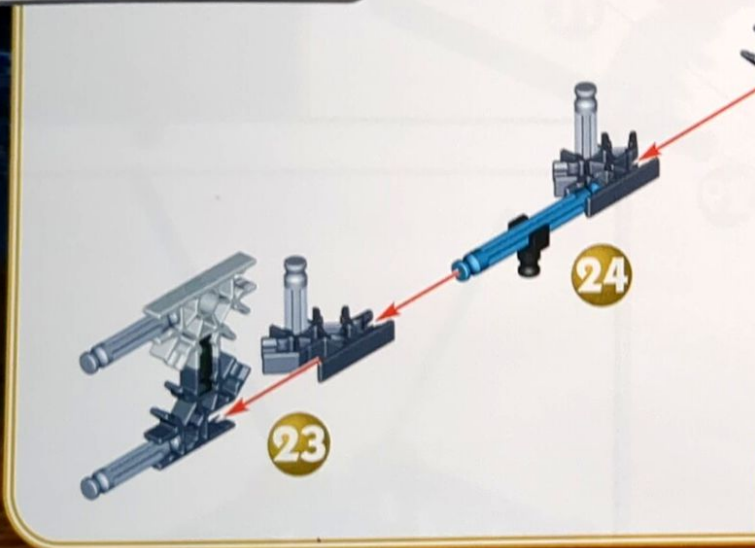
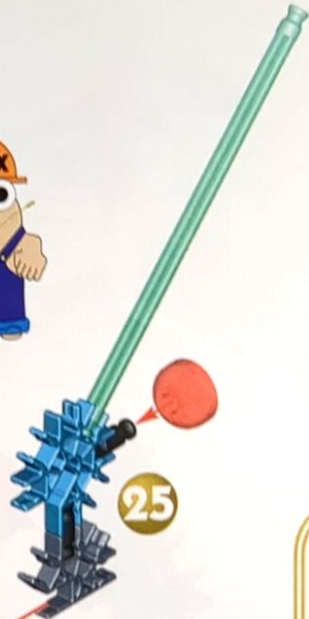

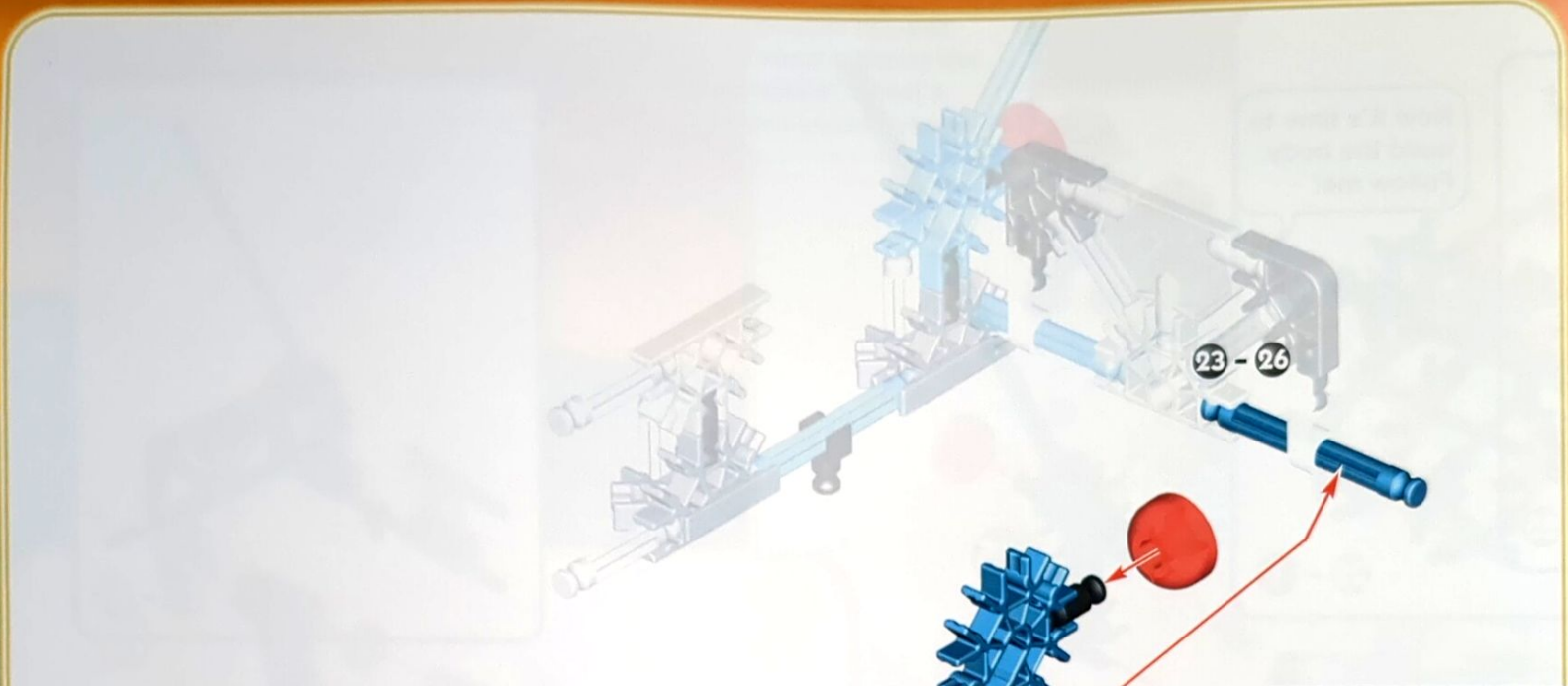

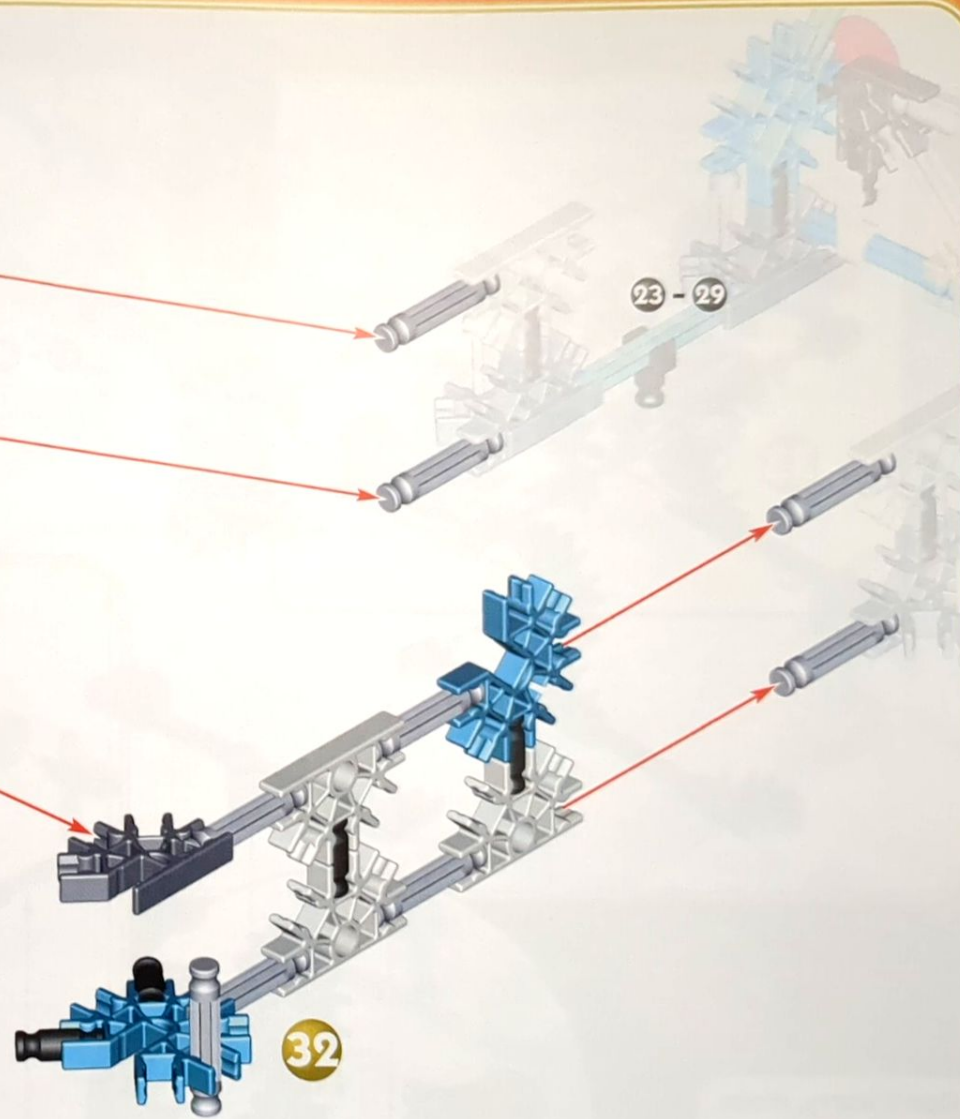
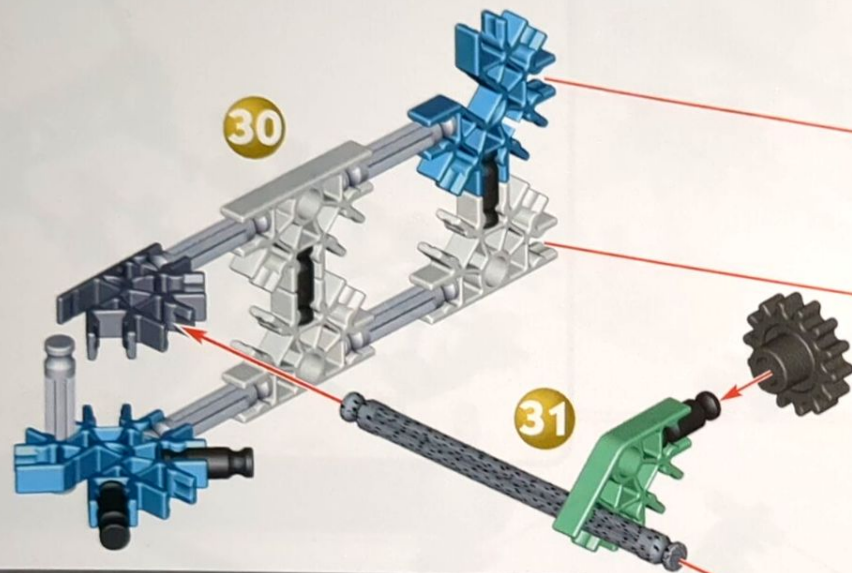

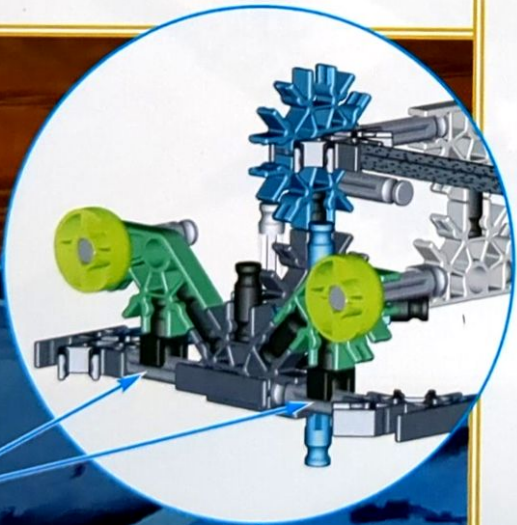
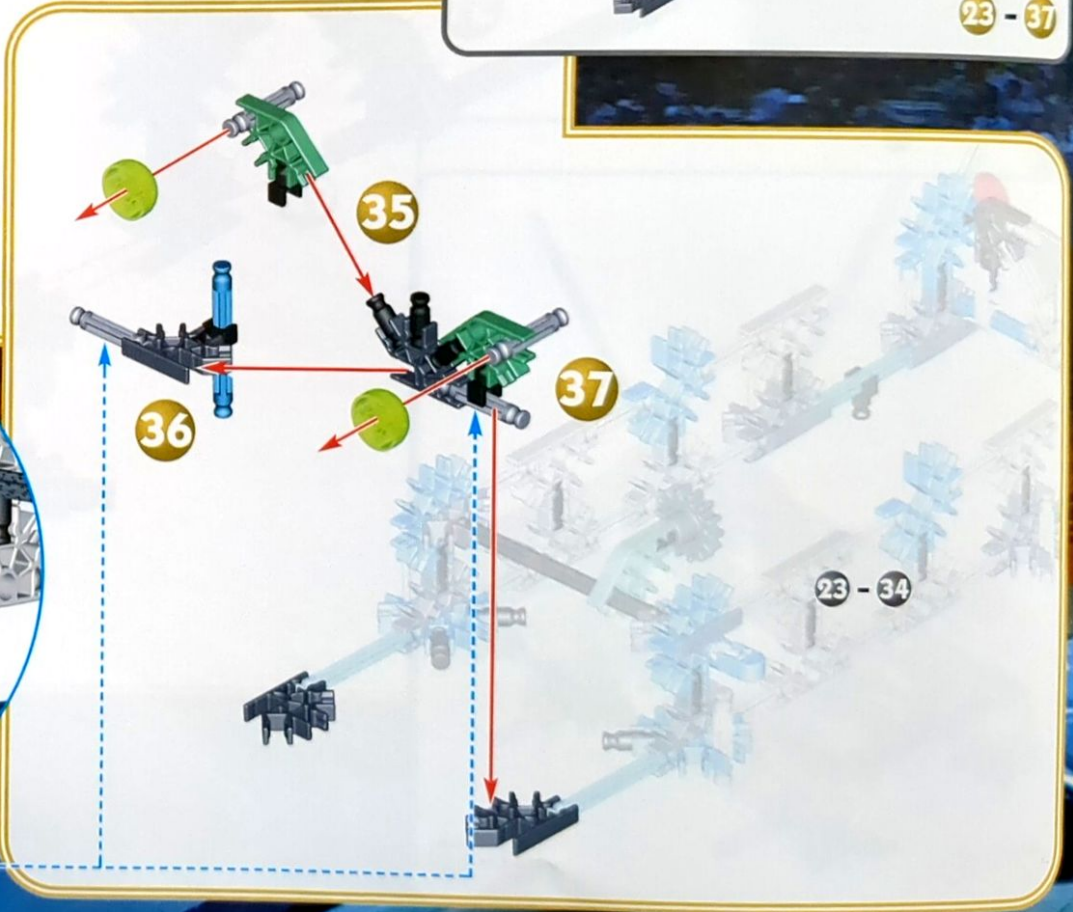
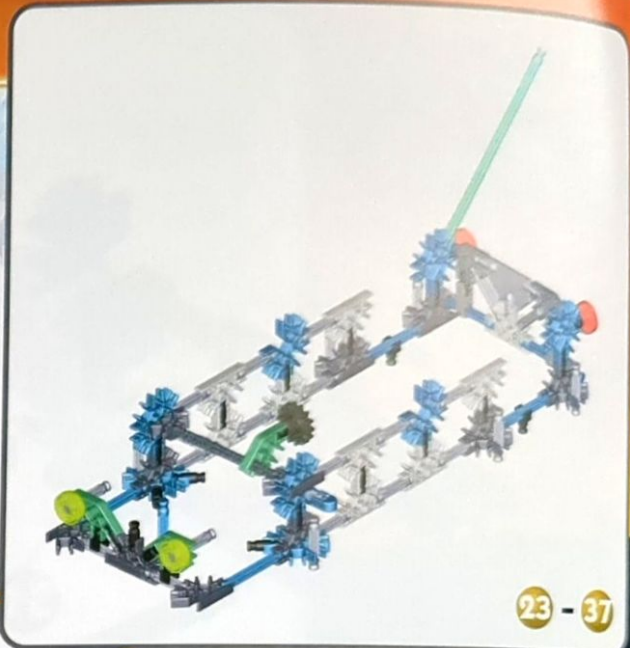

Don't worry, these pieces shouldn't connect together!



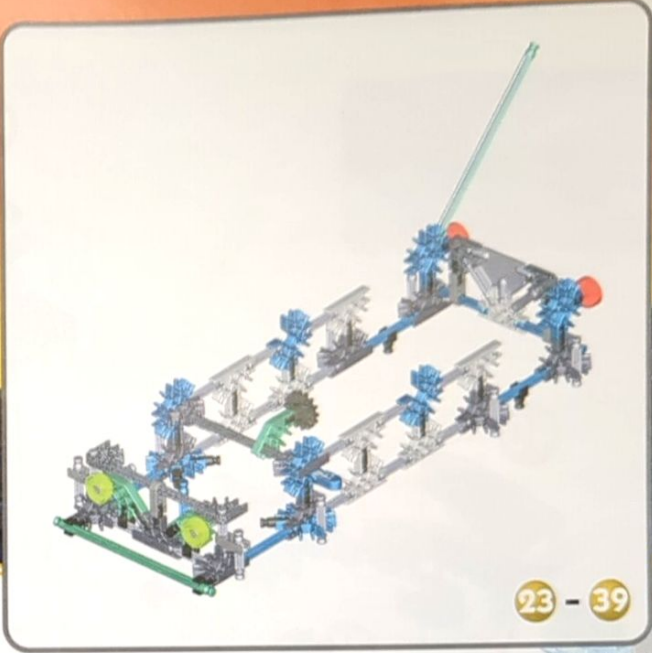
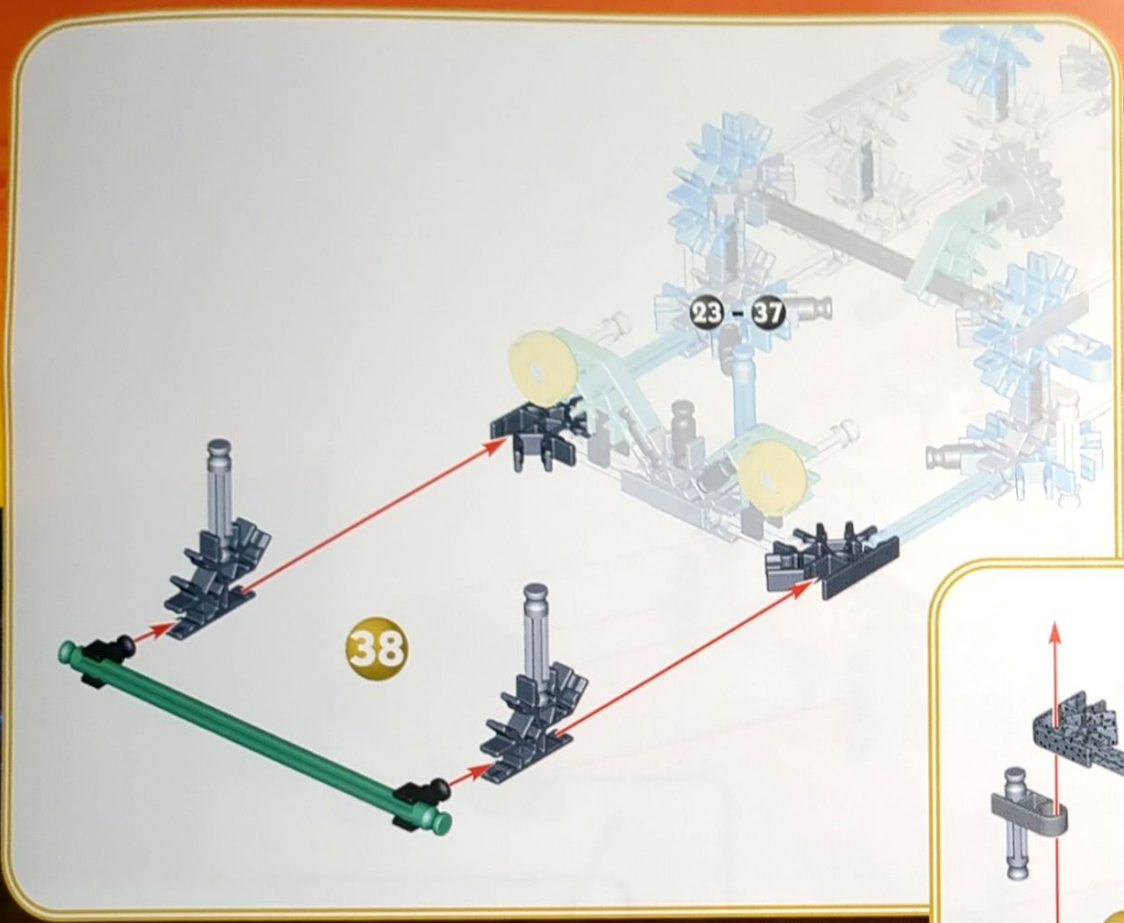

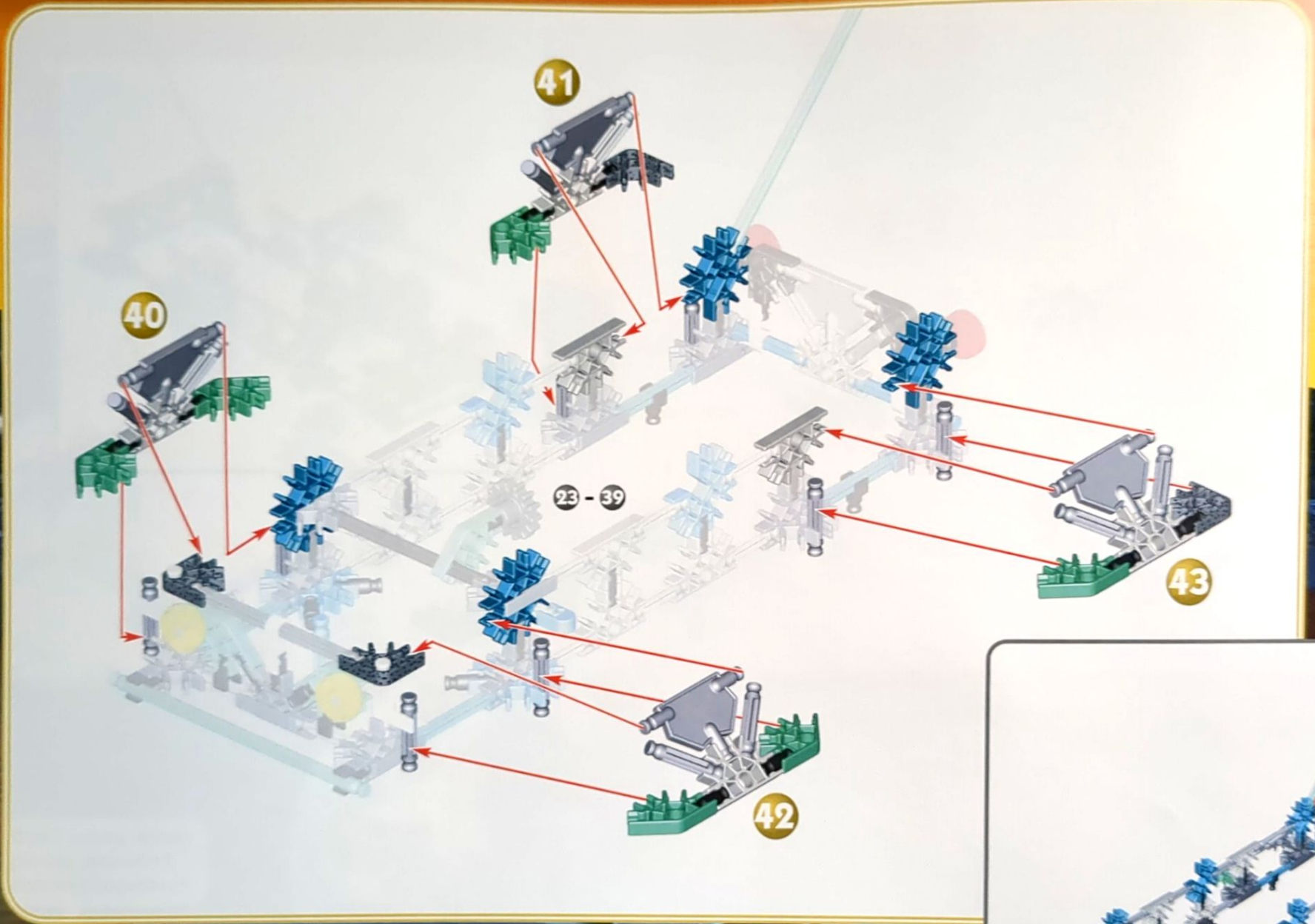

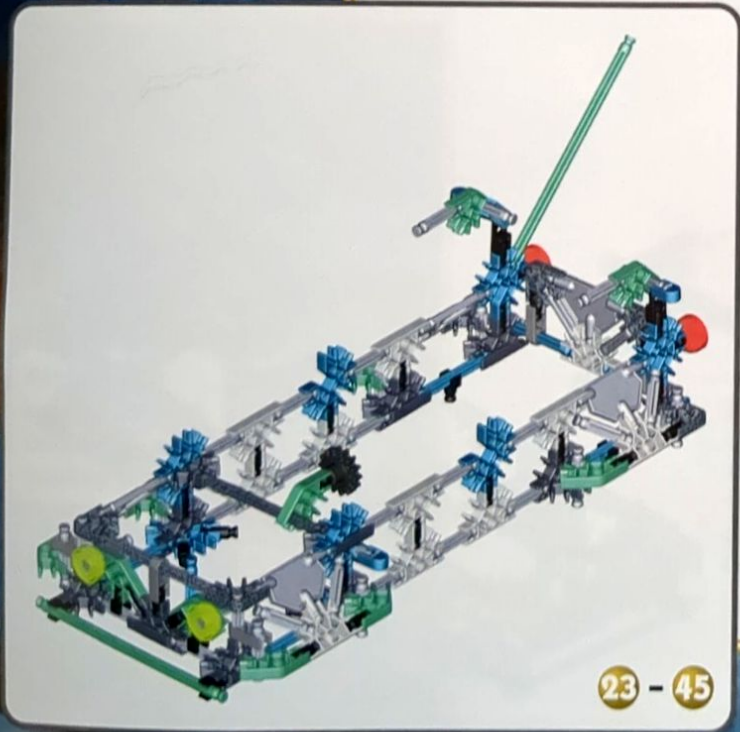
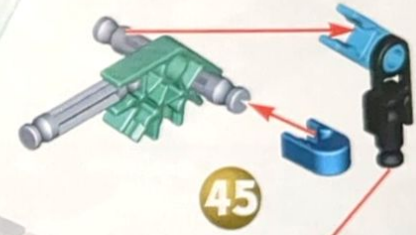
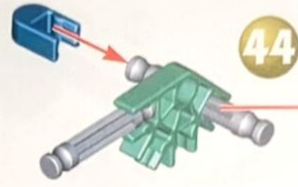



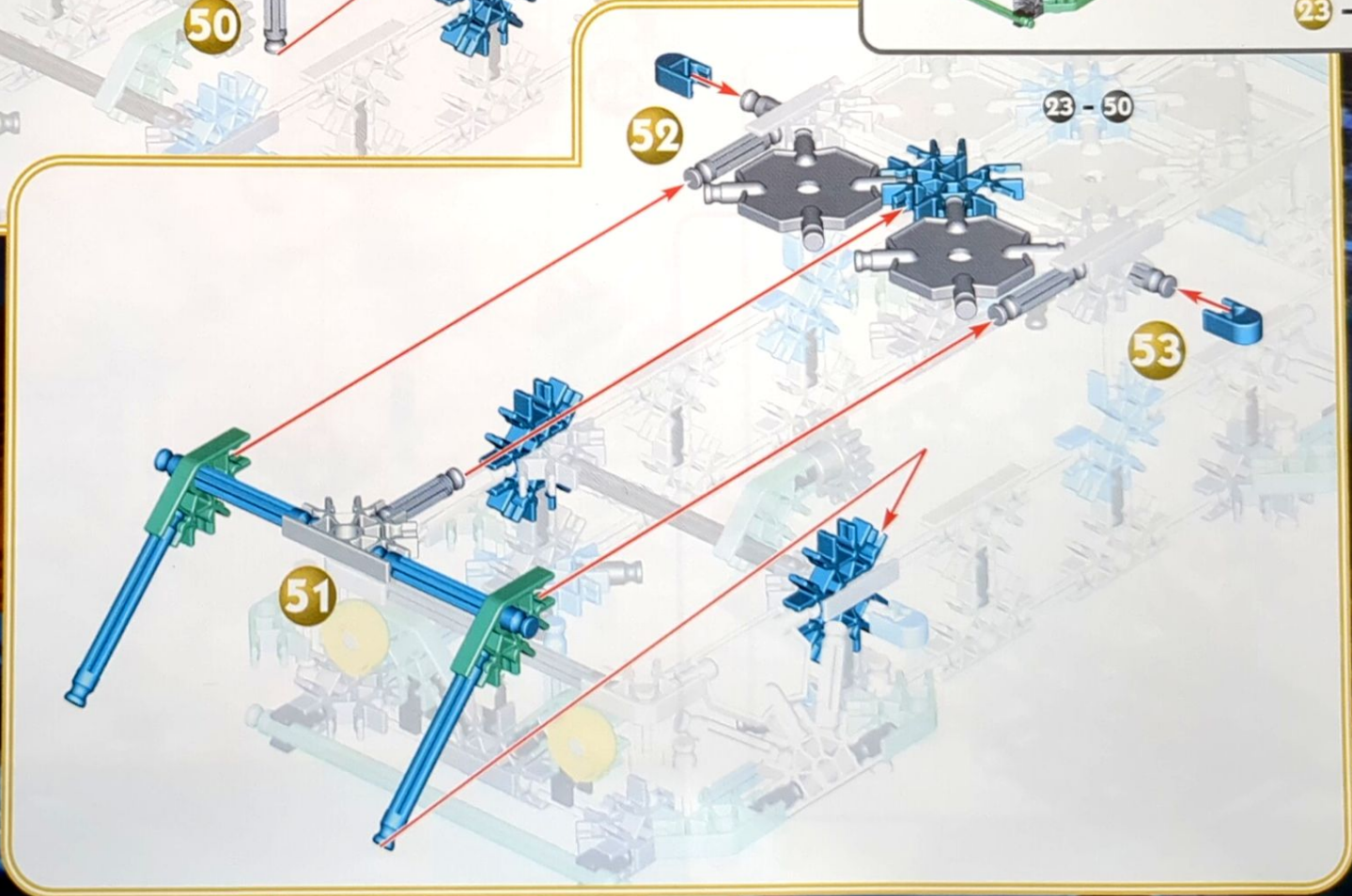
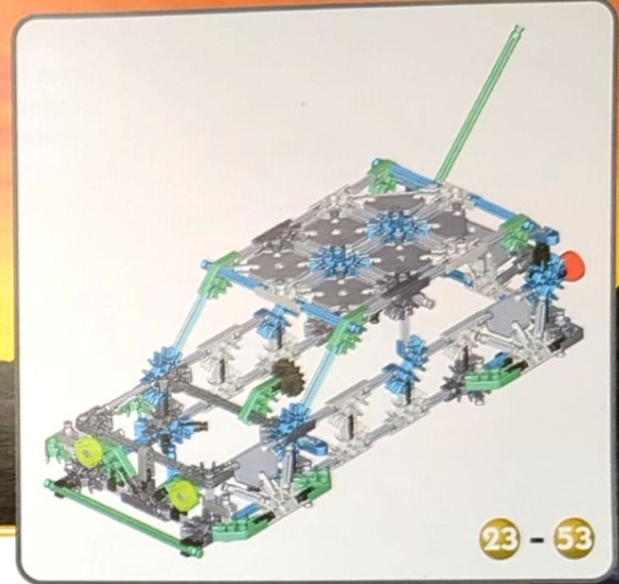
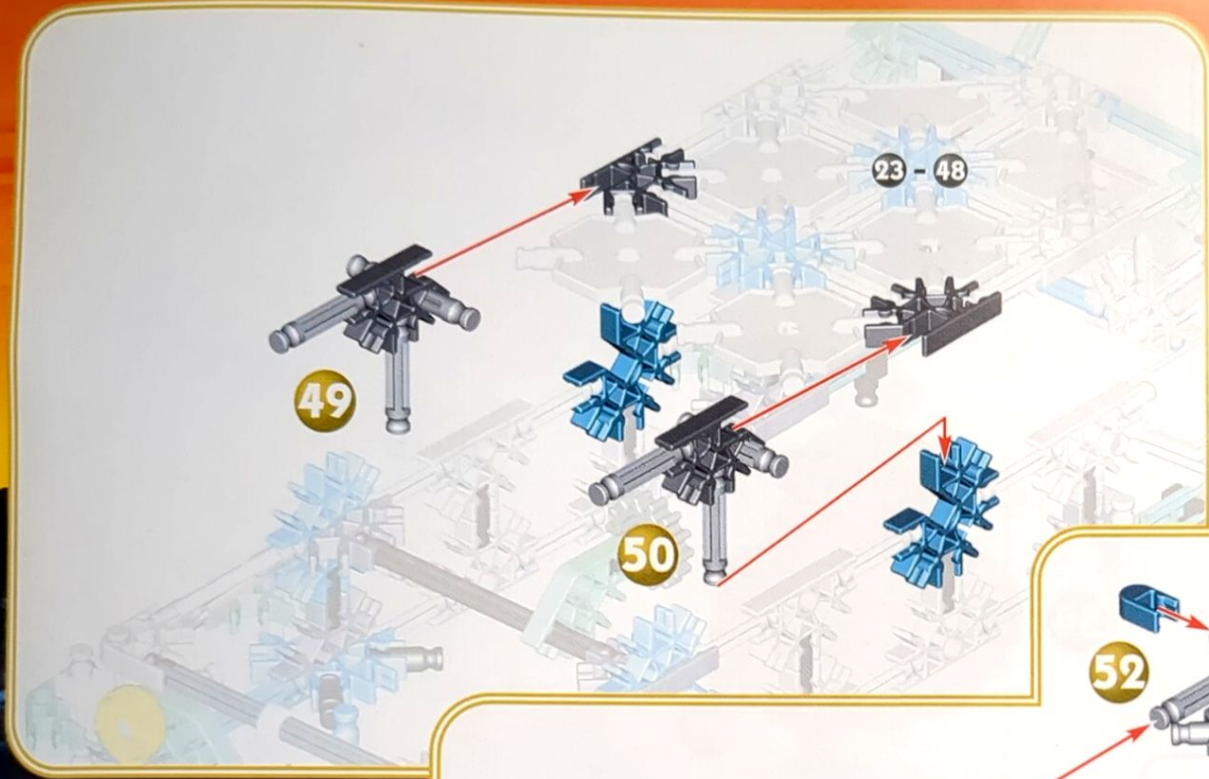

Yehaa! The body's almost done! Keep on truckin'!



Time to drop the engine in the engine bay.



54

55

23 - 53

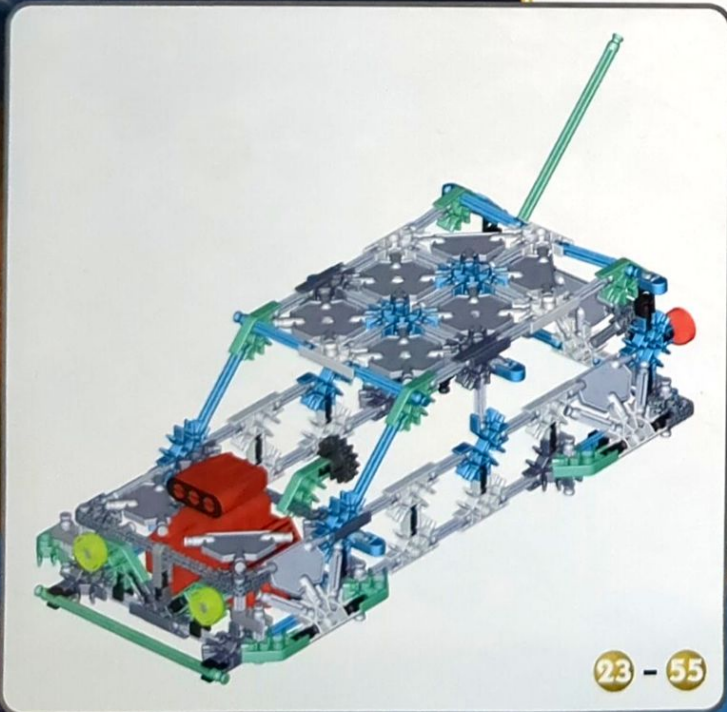
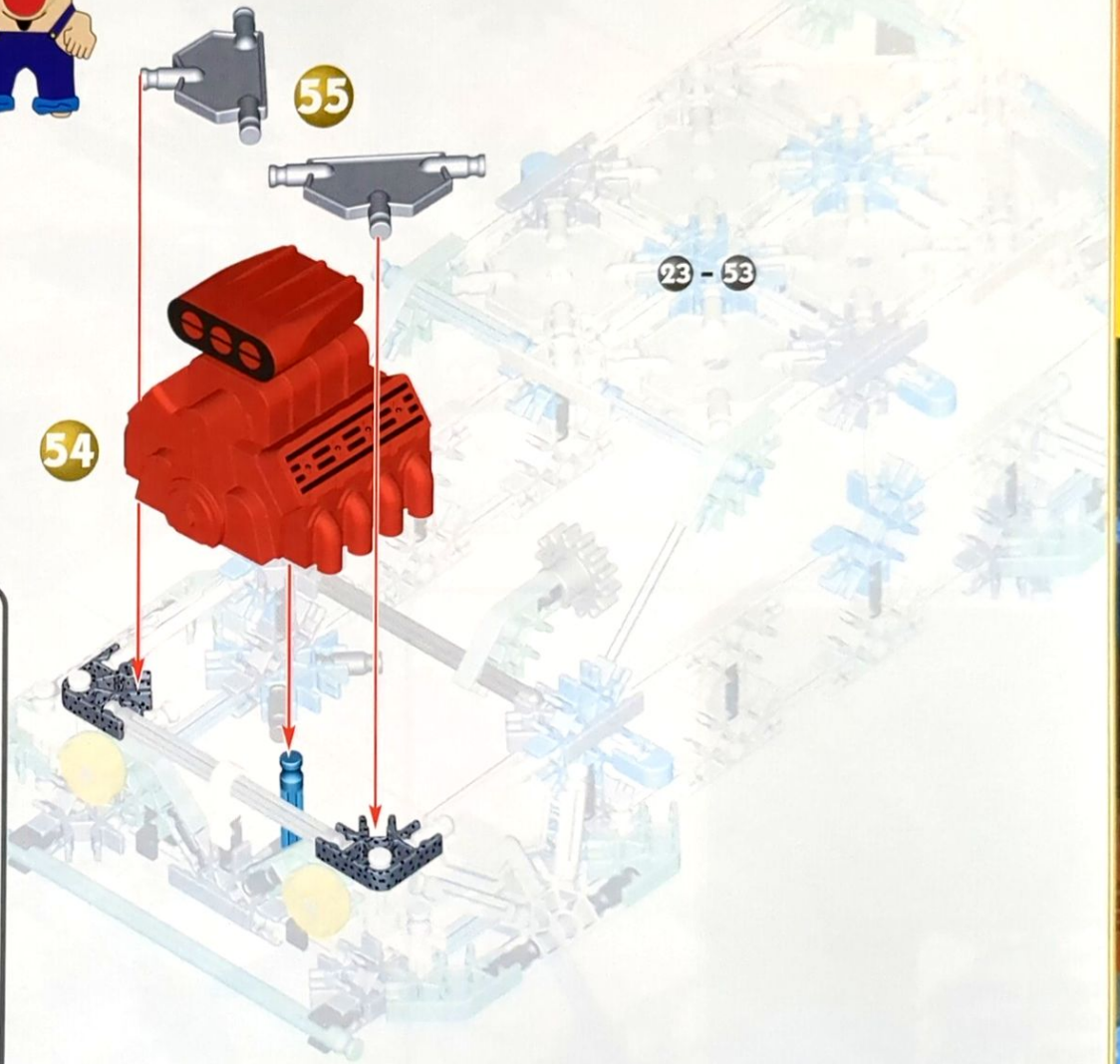

23 - 55

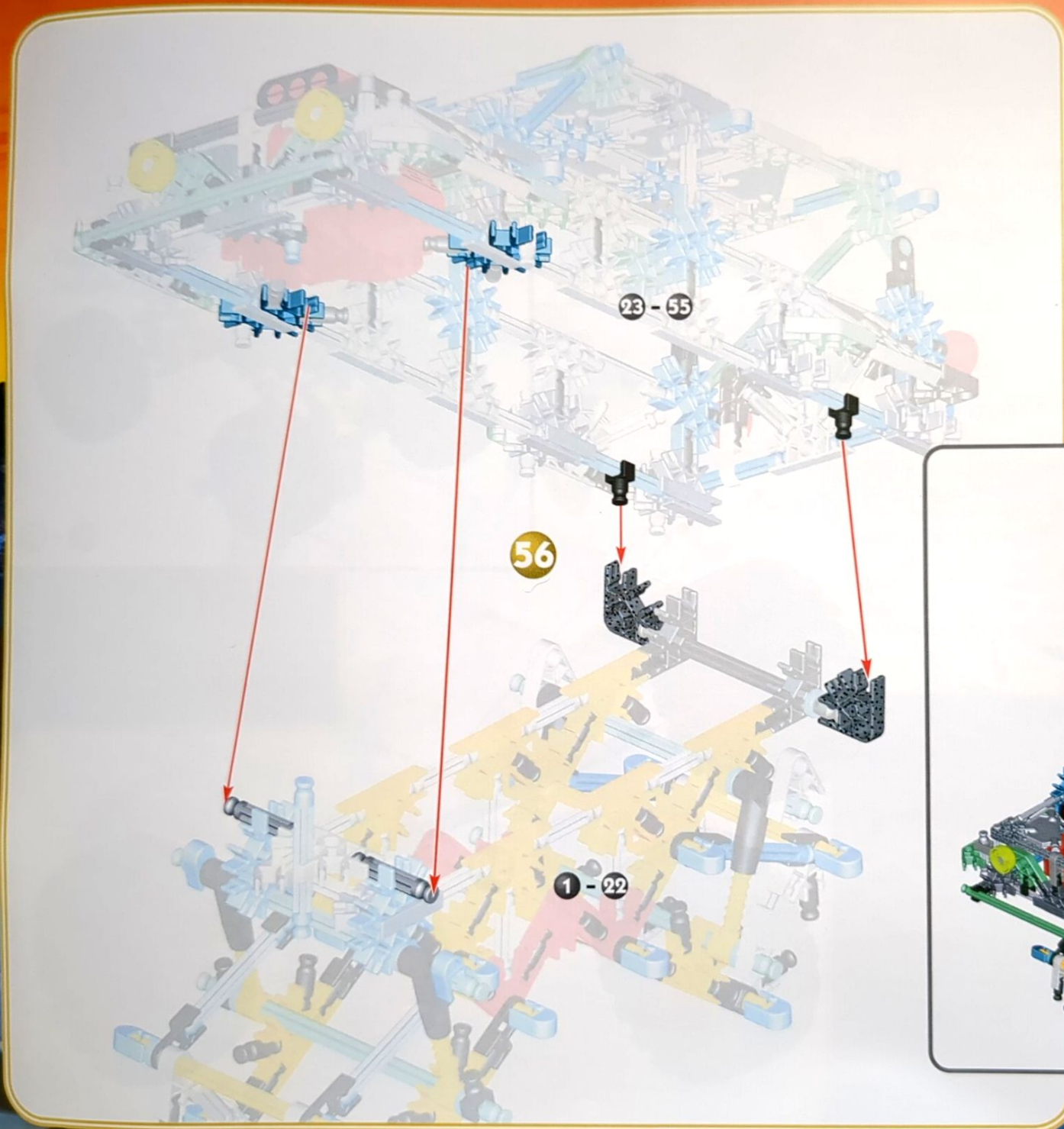

Now it's time to connect the body to the chassis!

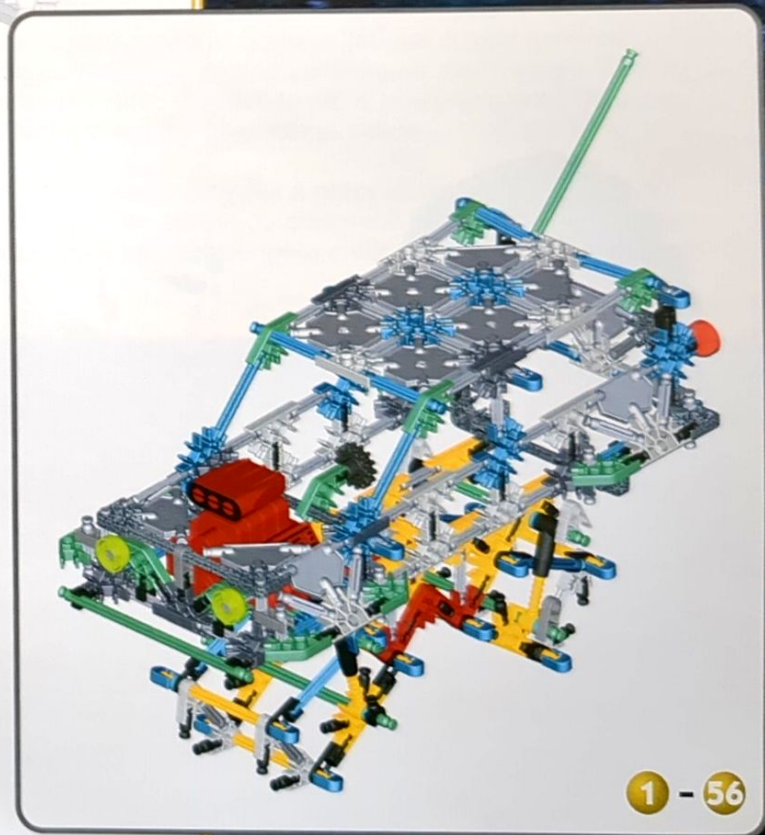

1 - 56

Push the wheels on until you hear a "click". Then you're ready for some car crushin' fun!



- Flag: Cut out and paste or tape the flag around the metallic green Rod.
- Drapeau: Découpe le drapeau et colle-le ou attache-le avec du ruban autour de la tige verte métallique.

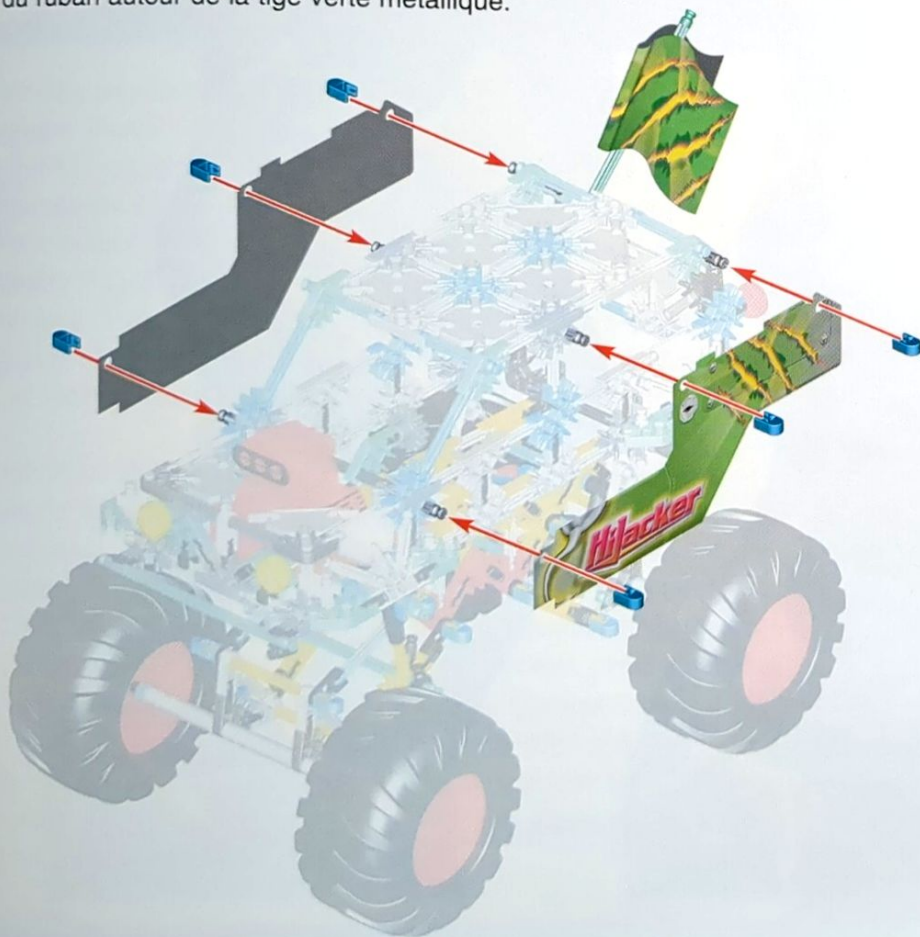

Cool Ways to play!

- Each Monster Truck in this set has been designed with a driver's seat. If you have a K'NEXman figure from another K'NEX set, put him in your truck for even more tough attitude!
- Trace the shape of the racing graphic panels onto white paper. Then try designing your own graphic panels and put them on your model for a personalized look!
- Chaque camion monstre dans ce jeu est conçu avec un siège de camionneur. Si tu as une figure de l'homme K'NEX d'un autre jeu K'NEX, place-la dans le camion pour créer un comportement encore plus fort et solide.
- Trace la forme des panneaux à graphiques de course sur du papier blanc. Puis, essaie de concevoir tes propres panneaux et attache-les à ton modèle pour créer un aspect personnalisé!

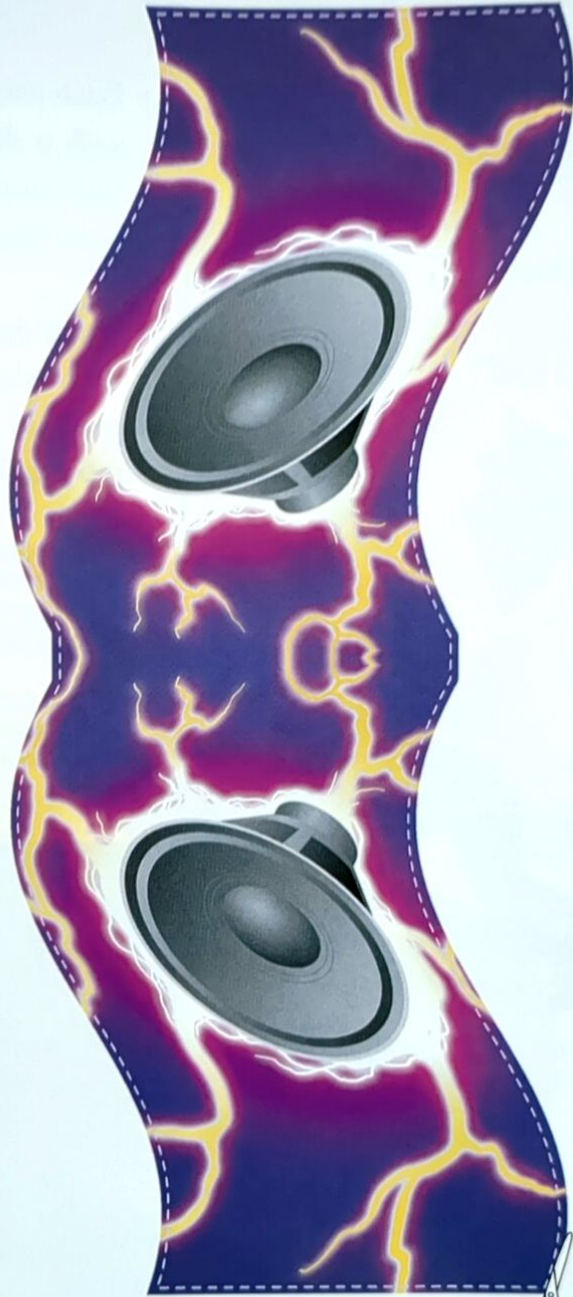

CONTENU

OVERDRIVE	5
POWER SURGE	30
HIJACKER	51

Bienvenue au monde de la course aux camions Monster Truck ! Les camions Monster Truck sont munis de pneus gigantesques, d'énormes moteurs et de graphiques de course qui expriment une attitude écrase-autos. Dans le cadre d'une course, deux camions Monster Truck se disputent, l'un à côté de l'autre, un parcours d'obstacles composés de sauts et de vieilles voitures rouillées. Le premier à franchir la ligne d'arrivée est le vainqueur!

Ce jeu OVERDRIVE vous permet de construire les camions Monster Truck les plus réels et les plus menaçants. Ayant comme modèle un vrai camion Monster Truck, le camion OVERDRIVE est caractérisé par des pneus gigantesques et une suspension pouvant écraser une auto. La carrosserie du camion peut même être soulevée pour révéler le siège du camionneur et le soubassement de carrosserie du camion! Une fois assemblé, attachez les graphiques de course personnalisés et le gros moteur pour créer un aspect très impressionnant!

Comment construire et monter avec K'NEX

1. Bonjour! Je suis ton camarade de montage K'NEX. Lorsque tu me vois dans les instructions, fais très attention aux détails indiqués.

2. Prépare-toi à construire

Pour commencer le modèle, trouve le numéro **1** et suis les chiffres. Chaque pièce a sa propre forme et couleur. Il suffit de regarder l'illustration, de trouver les pièces dans ton jeu qui correspondent à ce que tu vois et de les enclencher. Essaie de tenir le modèle dans le même sens que dans l'illustration. Ainsi, tes pièces seront attachées correctement.

3. Continuation

Les couleurs affaiblies indiquent que cette partie est déjà montée. Tu dois raccorder la nouvelle partie à l'endroit indiqué par les flèches. Ces pièces seront en pleine couleur.

4. Pièces d'écartement

Il y a des endroits dans ton modèle où tu dois ajouter des pièces d'écartement bleues et argentées. Assure-toi d'utiliser la couleur exacte et de compter les pièces avec soin.

5. Connecteurs

Tu trouveras des connecteurs bleus et argents comportant des fentes extra-longues. Ils se glissent l'un dans l'autre tel qu'illustré. Pousse les pièces ensemble jusqu'à ce que tu entendes un "déclat".

6. Amortisseurs

Les amortisseurs K'NEX viennent en deux pièces. Poussez-les ensemble jusqu'à ce que vous entendiez un "déclat".

K'NEX®

OVERDRIVE

MONSTER TRUCK



ALSO BUILDS
HIJACKER

ALSO BUILDS
POWER SURGE

Questions? Call us
at 1-800-KID-KNEX
(USA/Canada only)
www.knex.com

©2001 K'NEX Industries, Inc.
P.O. Box 700
Hatfield, PA 19440-0700

Colors and product may vary.
Le produit et les couleurs peuvent varier.

K'NEX is a registered trademark of K'NEX Industries, Inc.
K'NEX est une marque déposée de K'NEX Industries, Inc.

Manufactured under U.S. Patents/Fabriqu  sous brevets am ricains
5,061,219; 5,137,486; 5,199,919; 5,238,438; 5,346,480; 5,350,331;
5,368,514; 5,421,769; 5,423,707; 5,427,559; 5,518,435; D383,509;
D388,475; D389,203; D391,843; D391,921; D392,555. Other U.S.
and foreign patents pending./Autres brevets am ricains et
 trangers en instance.

Conforms to the Requirements of ASTM Standard Consumer Safety
Specification on Toy Safety, F963-96a.

Conforme aux sp cifications de s curit  du consommateur sur la
s curit  des jouets de la norme ASTM F963-96a.

93188-V1-1/01